

## Important notice

Dear Customer,

On 7 February 2017 the former NXP Standard Product business became a new company with the tradename **Nexperia**. Nexperia is an industry leading supplier of Discrete, Logic and PowerMOS semiconductors with its focus on the automotive, industrial, computing, consumer and wearable application markets

In data sheets and application notes which still contain NXP or Philips Semiconductors references, use the references to Nexperia, as shown below.

Instead of <http://www.nxp.com>, <http://www.philips.com/> or <http://www.semiconductors.philips.com/>, use <http://www.nexperia.com>

Instead of [sales.addresses@www.nxp.com](mailto:sales.addresses@www.nxp.com) or [sales.addresses@www.semiconductors.philips.com](mailto:sales.addresses@www.semiconductors.philips.com), use [salesaddresses@nexperia.com](mailto:salesaddresses@nexperia.com) (email)

Replace the copyright notice at the bottom of each page or elsewhere in the document, depending on the version, as shown below:

- © NXP N.V. (year). All rights reserved or © Koninklijke Philips Electronics N.V. (year). All rights reserved

Should be replaced with:

- © **Nexperia B.V. (year). All rights reserved.**

If you have any questions related to the data sheet, please contact our nearest sales office via e-mail or telephone (details via [salesaddresses@nexperia.com](mailto:salesaddresses@nexperia.com)). Thank you for your cooperation and understanding,

Kind regards,

Team Nexperia

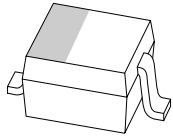

# PZUxBA series

## Single Zener diodes

Rev. 01 — 19 September 2008

Product data sheet

## 1. Product profile

### 1.1 General description

General-purpose Zener diodes in a SOD323 (SC-76) very small Surface-Mounted Device (SMD) plastic package.

### 1.2 Features

- Non-repetitive peak reverse power dissipation:  $P_{ZSM} \leq 40 \text{ W}$
- Total power dissipation:  $P_{tot} \leq 320 \text{ mW}$
- Tolerance series:  
B: approximately  $\pm 5 \%$ ;  
B1, B2, B3: approximately  $\pm 2 \%$
- Wide working voltage range:  
nominal 2.4 V to 36 V (E24 range)
- Low reverse current  $I_R$  range
- Small plastic package suitable for surface-mounted design
- AEC-Q101 qualified

### 1.3 Applications

- General regulation functions

### 1.4 Quick reference data

Table 1. Quick reference data

| Symbol    | Parameter                                     | Conditions                               | Min   | Typ | Max | Unit |
|-----------|---|--|-------|-----|-----|------|
| $V_F$     | forward voltage                               | $I_F = 100 \text{ mA}$                   | [1] - | -   | 1.1 | V    |
| $P_{ZSM}$ | non-repetitive peak reverse power dissipation |  | [2] - | -   | 40  | W    |
| $P_{tot}$ | total power dissipation                       | $T_{amb} \leq 25 \text{ }^\circ\text{C}$ | [3] - | -   | 320 | mW   |

[1] Pulse test:  $t_p \leq 300 \text{ } \mu\text{s}$ ;  $\delta \leq 0.02$ .

[2]  $t_p = 100 \text{ } \mu\text{s}$ ; square wave;  $T_j = 25 \text{ }^\circ\text{C}$  prior to surge

[3] Device mounted on an FR4 Printed-Circuit Board (PCB), single-sided copper, tin-plated and standard footprint.

## 2. Pinning information

**Table 2. Pinning**

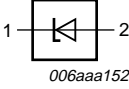
| Pin | Description                 | Simplified outline  | Graphic symbol  |
|-----|-----------------------------|---|---|
| 1   | cathode <a href="#">[1]</a> |  |  |
| 2   | anode                       |   |   |

[1] The marking bar indicates the cathode.

## 3. Ordering information

**Table 3. Ordering information**

| Type number   | Package |  |         |
|---|---------|--|---------|
|   | Name    | Description                              | Version |
| PZU2.4BA to PZU36BA <a href="#">[1]</a>                           | SC-76   | plastic surface-mounted package; 2 leads | SOD323  |
| PZU2.4BA/DG to PZU36BA/DG <a href="#">[1]</a> <a href="#">[2]</a> |         |  |         |

[1] The series consists of 97 types with nominal working voltages from 2.4 V to 36 V.

[2] /DG: halogen-free

## 4. Marking

Table 4. Marking codes

| Type number <sup>[1]</sup> | Marking code |    |    |    | Type number <sup>[1]</sup> | Marking code |    |    |    |
|----------------------------|--------------|----|----|----|----------------------------|--------------|----|----|----|
|                            | B            | B1 | B2 | B3 |                            | B            | B1 | B2 | B3 |
| PZU2.4*A                   | X8           | -  | -  | -  | PZU2.4*A/DG                | Y8           | -  | -  | -  |
| PZU2.7*A                   | X9           | XA | XB | -  | PZU2.7*A/DG                | Y9           | YA | YB | -  |
| PZU3.0*A                   | XT           | XU | XV | -  | PZU3.0*A/DG                | YT           | YU | YV | -  |
| PZU3.3*A                   | XW           | XX | XY | -  | PZU3.3*A/DG                | YW           | YX | YY | -  |
| PZU3.6*A                   | XZ           | MC | MD | -  | PZU3.6*A/DG                | YZ           | NC | ND | -  |
| PZU3.9*A                   | ME           | MF | MG | -  | PZU3.9*A/DG                | NE           | NF | NG | -  |
| PZU4.3*A                   | MM           | MN | MP | MR | PZU4.3*A/DG                | NM           | NN | NP | NR |
| PZU4.7*A                   | MS           | MT | MU | MV | PZU4.7*A/DG                | NS           | NT | NU | NV |
| PZU5.1*A                   | MW           | MX | MY | MZ | PZU5.1*A/DG                | NW           | NX | NY | NZ |
| PZU5.6*A                   | LF           | LG | LH | LK | PZU5.6*A/DG                | RF           | RG | RH | RK |
| PZU6.2*A                   | LL           | LM | LN | LP | PZU6.2*A/DG                | RL           | RM | RN | RP |
| PZU6.8*A                   | LR           | LS | LT | LU | PZU6.8*A/DG                | RR           | RS | RT | RU |
| PZU7.5*A                   | LV           | LW | LX | LY | PZU7.5*A/DG                | RV           | RW | RX | RY |
| PZU8.2*A                   | LZ           | CR | CS | CT | PZU8.2*A/DG                | RZ           | ER | ES | ET |
| PZU9.1*A                   | CU           | CV | CW | CX | PZU9.1*A/DG                | EU           | EV | EW | EX |
| PZU10*A                    | VA           | VB | VC | VD | PZU10*A/DG                 | WA           | WB | WC | WD |
| PZU11*A                    | VE           | VF | VG | VH | PZU11*A/DG                 | WE           | WF | WG | WH |
| PZU12*A                    | VK           | VL | VM | VN | PZU12*A/DG                 | WK           | WL | WM | WN |
| PZU13*A                    | VP           | VR | VS | VT | PZU13*A/DG                 | WP           | WR | WS | WT |
| PZU14*A                    | -            | -  | VU | -  | PZU14*A/DG                 | -            | -  | WU | -  |
| PZU15*A                    | VV           | VW | VX | VY | PZU15*A/DG                 | WV           | WW | WX | WY |
| PZU16*A                    | VZ           | X1 | X2 | X3 | PZU16*A/DG                 | WZ           | Y1 | Y2 | Y3 |
| PZU18*A                    | X4           | X5 | X6 | X7 | PZU18*A/DG                 | Y4           | Y5 | Y6 | Y7 |
| PZU20*A                    | XC           | XD | XE | XF | PZU20*A/DG                 | YC           | YD | YE | YF |
| PZU22*A                    | XG           | XH | XK | XL | PZU22*A/DG                 | YG           | YH | YK | YL |
| PZU24*A                    | XM           | XN | XP | XR | PZU24*A/DG                 | YM           | YN | YP | YR |
| PZU27*A                    | XS           | -  | -  | -  | PZU27*A/DG                 | YS           | -  | -  | -  |
| PZU30*A                    | MH           | -  | -  | -  | PZU30*A/DG                 | NH           | -  | -  | -  |
| PZU33*A                    | MK           | -  | -  | -  | PZU33*A/DG                 | NK           | -  | -  | -  |
| PZU36*A                    | ML           | -  | -  | -  | PZU36*A/DG                 | NL           | -  | -  | -  |

[1] \* = B: tolerance series B, approximately  $\pm 5\%$

\* = B1, B2, B3: tolerance series B1, B2, B3: approximately  $\pm 2\%$

## 5. Limiting values

**Table 5. Limiting values**

In accordance with the Absolute Maximum Rating System (IEC 60134).

| Symbol    | Parameter                                     | Conditions                  | Min   | Max               | Unit |
|-----------|---|-----------------------------|-------|-------------------|------|
| $I_F$     | forward current                               |                             | -     | 200               | mA   |
| $I_{ZSM}$ | non-repetitive peak reverse current           |                             | [1] - | see Table 8 and 9 |      |
| $P_{ZSM}$ | non-repetitive peak reverse power dissipation |                             | [1] - | 40                | W    |
| $P_{tot}$ | total power dissipation                       | $T_{amb} \leq 25\text{ °C}$ | [2] - | 320               | mW   |
|           |   |                             | [3] - | 490               | mW   |
| $T_j$     | junction temperature                          |                             | -     | 150               | °C   |
| $T_{amb}$ | ambient temperature                           |                             | -55   | +150              | °C   |
| $T_{stg}$ | storage temperature                           |                             | -65   | +150              | °C   |

[1]  $t_p = 100\ \mu\text{s}$ ; square wave;  $T_j = 25\text{ °C}$  prior to surge

[2] Device mounted on an FR4 PCB, single-sided copper, tin-plated and standard footprint.

[3] Device mounted on an FR4 PCB, single-sided copper, tin-plated, mounting pad for cathode 1 cm<sup>2</sup>.

## 6. Thermal characteristics

**Table 6. Thermal characteristics**

| Symbol         | Parameter  | Conditions  | Min   | Typ | Max | Unit |
|----------------|--|-------------|-------|-----|-----|------|
| $R_{th(j-a)}$  | thermal resistance from junction to ambient      | in free air | [1] - | -   | 390 | K/W  |
|                |  |             | [2] - | -   | 255 | K/W  |
| $R_{th(j-sp)}$ | thermal resistance from junction to solder point |             | [3] - | -   | 55  | K/W  |

[1] Device mounted on an FR4 PCB, single-sided copper, tin-plated and standard footprint.

[2] Device mounted on an FR4 PCB, single-sided copper, tin-plated, mounting pad for cathode 1 cm<sup>2</sup>.

[3] Soldering point of cathode tab.

## 7. Characteristics

**Table 7. Characteristics**

$T_j = 25\text{ °C}$  unless otherwise specified.

| Symbol | Parameter       | Conditions            | Min | Typ | Max | Unit |
|--------|-----------------|-----------------------|-----|-----|-----|------|
| $V_F$  | forward voltage |                       | [1] |     |     |      |
|        |                 | $I_F = 10\text{ mA}$  | -   | -   | 0.9 | V    |
|        |                 | $I_F = 100\text{ mA}$ | -   | -   | 1.1 | V    |

[1] Pulse test:  $t_p \leq 300\ \mu\text{s}$ ;  $\delta \leq 0.02$ .

**Table 8. Characteristics per type; PZU2.4BA to PZU5.6B3A and PZU2.4BA/DG to PZU5.6B3A/DG***T<sub>J</sub> = 25 °C unless otherwise specified.*

| PZUxBA | Sel | Working voltage<br>V <sub>Z</sub> (V) |      | Differential resistance<br>r <sub>dif</sub> (Ω) |     | Reverse current<br>I <sub>R</sub> (μA) |                    | Temperature coefficient<br>S <sub>Z</sub> (mV/K) | Diode capacitance<br>C <sub>d</sub> (pF) <sup>[1]</sup> | Non-repetitive peak reverse current<br>I <sub>ZSM</sub> (A) <sup>[2]</sup> |
|--------|-----|---------------------------------------|------|---|-----|--|--------------------|--|---|--|
|        |     |                                       |      |   |     |  |                    |  |   |  |
|        |     | Min                                   | Max  | Max   | Max | Max                                    | V <sub>R</sub> (V) | Typ  | Max   | Max  |
| 2.4    | B   | 2.3                                   | 2.6  | 1000  | 100 | 50                                     | 1                  | -1.6   | 450   | 8  |
| 2.7    | B   | 2.5                                   | 2.9  | 1000  | 100 | 20                                     | 1                  | -2.0   | 440   | 8  |
|        | B1  | 2.5                                   | 2.75 |   |     |  |                    |  |   |  |
|        | B2  | 2.65                                  | 2.9  |   |     |  |                    |  |   |  |
| 3.0    | B   | 2.8                                   | 3.2  | 1000  | 95  | 10                                     | 1                  | -2.1   | 425   | 8  |
|        | B1  | 2.8                                   | 3.05 |   |     |  |                    |  |   |  |
|        | B2  | 2.95                                  | 3.2  |   |     |  |                    |  |   |  |
| 3.3    | B   | 3.1                                   | 3.5  | 1000  | 95  | 5                                      | 1                  | -2.4   | 410   | 8  |
|        | B1  | 3.1                                   | 3.35 |   |     |  |                    |  |   |  |
|        | B2  | 3.25                                  | 3.5  |   |     |  |                    |  |   |  |
| 3.6    | B   | 3.4                                   | 3.8  | 1000  | 90  | 5                                      | 1                  | -2.4   | 390   | 8  |
|        | B1  | 3.4                                   | 3.65 |   |     |  |                    |  |   |  |
|        | B2  | 3.55                                  | 3.8  |   |     |  |                    |  |   |  |
| 3.9    | B   | 3.7                                   | 4.1  | 1000  | 90  | 3                                      | 1                  | -2.5   | 370   | 8  |
|        | B1  | 3.7                                   | 3.97 |   |     |  |                    |  |   |  |
|        | B2  | 3.87                                  | 4.10 |   |     |  |                    |  |   |  |
| 4.3    | B   | 4.01                                  | 4.48 | 1000  | 90  | 3                                      | 1                  | -2.5   | 350   | 8  |
|        | B1  | 4.01                                  | 4.21 |   |     |  |                    |  |   |  |
|        | B2  | 4.15                                  | 4.34 |   |     |  |                    |  |   |  |
|        | B3  | 4.28                                  | 4.48 |   |     |  |                    |  |   |  |
| 4.7    | B   | 4.42                                  | 4.9  | 800   | 80  | 2                                      | 1                  | -1.4   | 325   | 8  |
|        | B1  | 4.42                                  | 4.61 |   |     |  |                    |  |   |  |
|        | B2  | 4.55                                  | 4.75 |   |     |  |                    |  |   |  |
|        | B3  | 4.69                                  | 4.9  |   |     |  |                    |  |   |  |
| 5.1    | B   | 4.84                                  | 5.37 | 250   | 60  | 2                                      | 1.5                | 0.3  | 300   | 5.5  |
|        | B1  | 4.84                                  | 5.04 |   |     |  |                    |  |   |  |
|        | B2  | 4.98                                  | 5.2  |   |     |  |                    |  |   |  |
|        | B3  | 5.14                                  | 5.37 |   |     |  |                    |  |   |  |
| 5.6    | B   | 5.31                                  | 5.92 | 100   | 40  | 1                                      | 2.5                | 1.9  | 275   | 5.5  |
|        | B1  | 5.31                                  | 5.55 |   |     |  |                    |  |   |  |
|        | B2  | 5.49                                  | 5.73 |   |     |  |                    |  |   |  |
|        | B3  | 5.67                                  | 5.92 |   |     |  |                    |  |   |  |

[1] f = 1 MHz; V<sub>R</sub> = 0 V[2] t<sub>p</sub> = 100 μs; square wave; T<sub>J</sub> = 25 °C prior to surge

**Table 9. Characteristics per type; PZU6.2BA to PZU36BA and PZU6.2BA/DG to PZU36BA/DG***T<sub>j</sub> = 25 °C unless otherwise specified.*

| PZUxBA | Sel | Working voltage<br>V <sub>Z</sub> (V) |       | Differential resistance<br>r <sub>dif</sub> (Ω) |     | Reverse current<br>I <sub>R</sub> (nA) |                    | Temperature coefficient<br>S <sub>Z</sub> (mV/K) | Diode capacitance<br>C <sub>d</sub> (pF) <sup>[1]</sup> | Non-repetitive peak reverse current<br>I <sub>ZSM</sub> (A) <sup>[2]</sup> |
|--------|-----|---------------------------------------|-------|---|-----|--|--------------------|--|---|--|
|        |     |                                       |       |   |     |  |                    |  |   |  |
|        |     | Min                                   | Max   | Max   | Max | Max                                    | V <sub>R</sub> (V) | Typ  | Max   | Max  |
| 6.2    | B   | 5.86                                  | 6.53  | 80  | 30  | 500                                    | 3                  | 2.7  | 250   | 5.5  |
|        | B1  | 5.86                                  | 6.12  |   |     |  |                    |  |   |  |
|        | B2  | 6.06                                  | 6.33  |   |     |  |                    |  |   |  |
|        | B3  | 6.26                                  | 6.53  |   |     |  |                    |  |   |  |
| 6.8    | B   | 6.47                                  | 7.14  | 60  | 20  | 500                                    | 3.5                | 3.4  | 215   | 5.5  |
|        | B1  | 6.47                                  | 6.73  |   |     |  |                    |  |   |  |
|        | B2  | 6.65                                  | 6.93  |   |     |  |                    |  |   |  |
|        | B3  | 6.86                                  | 7.14  |   |     |  |                    |  |   |  |
| 7.5    | B   | 7.06                                  | 7.84  | 60  | 10  | 500                                    | 4                  | 4.0  | 170   | 3.5  |
|        | B1  | 7.06                                  | 7.36  |   |     |  |                    |  |   |  |
|        | B2  | 7.28                                  | 7.60  |   |     |  |                    |  |   |  |
|        | B3  | 7.52                                  | 7.84  |   |     |  |                    |  |   |  |
| 8.2    | B   | 7.76                                  | 8.64  | 60  | 10  | 500                                    | 5                  | 4.6  | 150   | 3.5  |
|        | B1  | 7.76                                  | 8.1   |   |     |  |                    |  |   |  |
|        | B2  | 8.02                                  | 8.36  |   |     |  |                    |  |   |  |
|        | B3  | 8.28                                  | 8.64  |   |     |  |                    |  |   |  |
| 9.1    | B   | 8.56                                  | 9.55  | 60  | 10  | 500                                    | 6                  | 5.5  | 120   | 3.5  |
|        | B1  | 8.56                                  | 8.93  |   |     |  |                    |  |   |  |
|        | B2  | 8.85                                  | 9.23  |   |     |  |                    |  |   |  |
|        | B3  | 9.15                                  | 9.55  |   |     |  |                    |  |   |  |
| 10     | B   | 9.45                                  | 10.55 | 60  | 10  | 100                                    | 7                  | 6.4  | 110   | 3.5  |
|        | B1  | 9.45                                  | 9.87  |   |     |  |                    |  |   |  |
|        | B2  | 9.77                                  | 10.21 |   |     |  |                    |  |   |  |
|        | B3  | 10.11                                 | 10.55 |   |     |  |                    |  |   |  |
| 11     | B   | 10.44                                 | 11.56 | 60  | 10  | 100                                    | 8                  | 7.4  | 108   | 3  |
|        | B1  | 10.44                                 | 10.88 |   |     |  |                    |  |   |  |
|        | B2  | 10.76                                 | 11.22 |   |     |  |                    |  |   |  |
|        | B3  | 11.1                                  | 11.56 |   |     |  |                    |  |   |  |
| 12     | B   | 11.42                                 | 12.6  | 80  | 10  | 100                                    | 9                  | 8.4  | 105   | 3  |
|        | B1  | 11.42                                 | 11.9  |   |     |  |                    |  |   |  |
|        | B2  | 11.74                                 | 12.24 |   |     |  |                    |  |   |  |
|        | B3  | 12.08                                 | 12.6  |   |     |  |                    |  |   |  |
| 13     | B   | 12.47                                 | 13.96 | 80  | 10  | 100                                    | 10                 | 9.4  | 103   | 2.5  |
|        | B1  | 12.47                                 | 13.03 |   |     |  |                    |  |   |  |
|        | B2  | 12.91                                 | 13.49 |   |     |  |                    |  |   |  |
|        | B3  | 13.37                                 | 13.96 |   |     |  |                    |  |   |  |

**Table 9. Characteristics per type; PZU6.2BA to PZU36BA and PZU6.2BA/DG to PZU36BA/DG ...continued**  
 $T_j = 25\text{ }^\circ\text{C}$  unless otherwise specified.

| PZUxBA | Sel | Working voltage $V_Z$ (V) |       | Differential resistance $r_{\text{dif}}$ ( $\Omega$ ) |                     | Reverse current $I_R$ (nA) |           | Temperature coefficient $S_Z$ (mV/K) | Diode capacitance $C_d$ (pF) <sup>[1]</sup> | Non-repetitive peak reverse current $I_{ZSM}$ (A) <sup>[2]</sup> |
|--------|-----|---------------------------|-------|---|---------------------|----------------------------|-----------|--------------------------------------|---|--|
|        |     |                           |       | $I_Z = 0.5\text{ mA}$                                 | $I_Z = 5\text{ mA}$ |                            |           | $I_Z = 5\text{ mA}$                  |   |  |
|        |     | Min                       | Max   | Max   | Max                 | Max                        | $V_R$ (V) | Typ                                  | Max   | Max  |
| 14     | B2  | 13.70                     | 14.30 | 80  | 10                  | 100                        | 11        | 10.4                                 | 101   | 2  |
| 15     | B   | 13.84                     | 15.52 | 80  | 15                  | 50                         | 11        | 11.4                                 | 99  | 2  |
|        | B1  | 13.84                     | 14.46 |   |                     |                            |           |                                      |   |  |
|        | B2  | 14.34                     | 14.98 |   |                     |                            |           |                                      |   |  |
|        | B3  | 14.85                     | 15.52 |   |                     |                            |           |                                      |   |  |
| 16     | B   | 15.37                     | 17.09 | 80  | 20                  | 50                         | 12        | 12.4                                 | 97  | 1.5  |
|        | B1  | 15.37                     | 16.01 |   |                     |                            |           |                                      |   |  |
|        | B2  | 15.85                     | 16.51 |   |                     |                            |           |                                      |   |  |
|        | B3  | 16.35                     | 17.09 |   |                     |                            |           |                                      |   |  |
| 18     | B   | 16.94                     | 19.03 | 80  | 20                  | 50                         | 13        | 14.4                                 | 93  | 1.5  |
|        | B1  | 16.94                     | 17.7  |   |                     |                            |           |                                      |   |  |
|        | B2  | 17.56                     | 18.35 |   |                     |                            |           |                                      |   |  |
|        | B3  | 18.21                     | 19.03 |   |                     |                            |           |                                      |   |  |
| 20     | B   | 18.86                     | 21.08 | 100   | 20                  | 50                         | 15        | 16.4                                 | 88  | 1.5  |
|        | B1  | 18.86                     | 19.7  |   |                     |                            |           |                                      |   |  |
|        | B2  | 19.52                     | 20.39 |   |                     |                            |           |                                      |   |  |
|        | B3  | 20.21                     | 21.08 |   |                     |                            |           |                                      |   |  |
| 22     | B   | 20.88                     | 23.17 | 100   | 25                  | 50                         | 17        | 18.4                                 | 84  | 1.3  |
|        | B1  | 20.88                     | 21.77 |   |                     |                            |           |                                      |   |  |
|        | B2  | 21.54                     | 22.47 |   |                     |                            |           |                                      |   |  |
|        | B3  | 22.23                     | 23.17 |   |                     |                            |           |                                      |   |  |
| 24     | B   | 22.93                     | 25.57 | 120   | 30                  | 50                         | 19        | 20.4                                 | 80  | 1.3  |
|        | B1  | 22.93                     | 23.96 |   |                     |                            |           |                                      |   |  |
|        | B2  | 23.72                     | 24.78 |   |                     |                            |           |                                      |   |  |
|        | B3  | 24.54                     | 25.57 |   |                     |                            |           |                                      |   |  |
| 27     | B   | 25.1                      | 28.9  | 150   | 40                  | 50                         | 21        | 23.4                                 | 73  | 1  |
| 30     | B   | 28                        | 32    | 200   | 40                  | 50                         | 23        | 26.6                                 | 66  | 1  |
| 33     | B   | 31                        | 35    | 250   | 40                  | 50                         | 25        | 29.7                                 | 60  | 0.9  |
| 36     | B   | 34                        | 38    | 300   | 60                  | 50                         | 27        | 33.0                                 | 59  | 0.8  |

[1]  $f = 1\text{ MHz}$ ;  $V_R = 0\text{ V}$

[2]  $t_p = 100\text{ }\mu\text{s}$ ; square wave;  $T_j = 25\text{ }^\circ\text{C}$  prior to surge



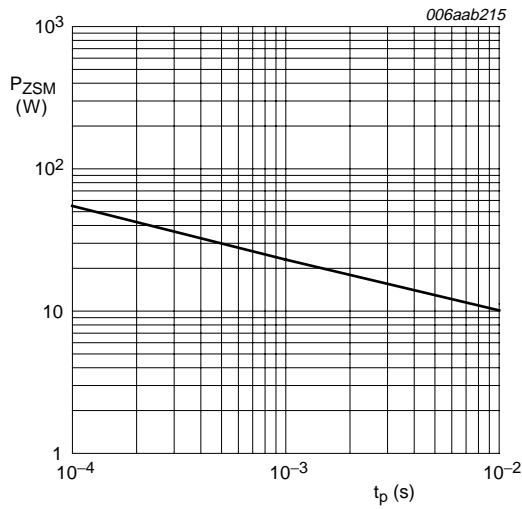

$T_j = 25\text{ }^\circ\text{C}$  (prior to surge)

**Fig 1. Non-repetitive peak reverse power dissipation as a function of pulse duration; maximum values**

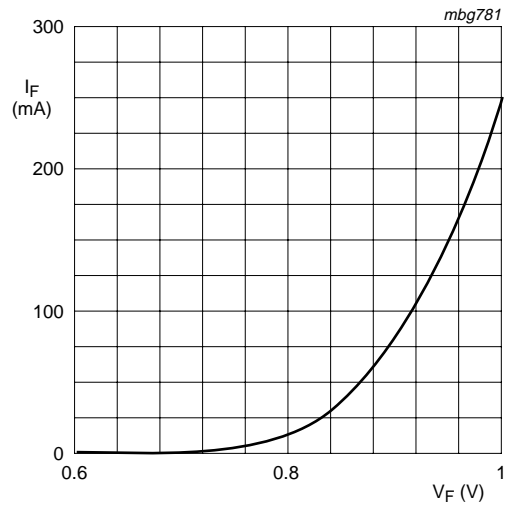

$T_j = 25\text{ }^\circ\text{C}$

**Fig 2. Forward current as a function of forward voltage; typical values**

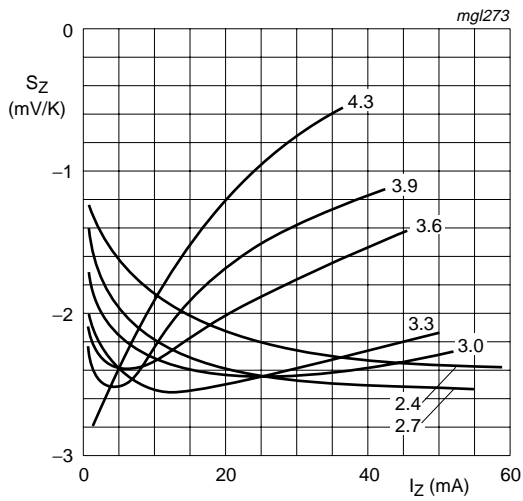

$T_j = 25\text{ }^\circ\text{C}$  to  $150\text{ }^\circ\text{C}$   
 $V_Z = 2.4\text{ V}$  to  $4.3\text{ V}$

**Fig 3. Temperature coefficient as a function of working current; typical values**

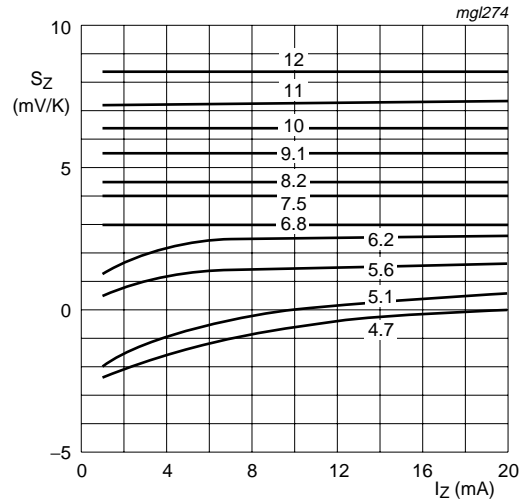

$T_j = 25\text{ }^\circ\text{C}$  to  $150\text{ }^\circ\text{C}$   
 $V_Z = 4.7\text{ V}$  to  $12\text{ V}$

**Fig 4. Temperature coefficient as a function of working current; typical values**

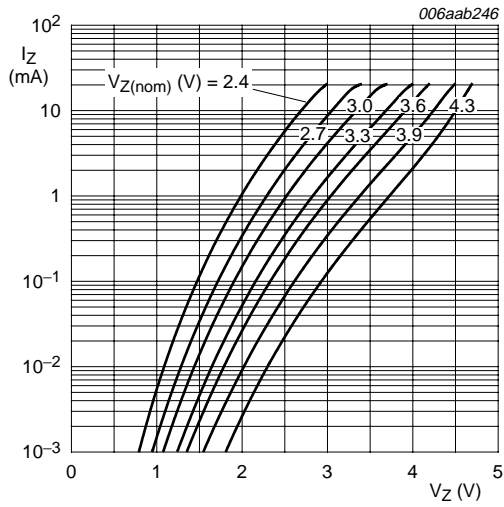

$T_j = 25\text{ }^\circ\text{C}$   
 $V_Z = 2.4\text{ V to }4.3\text{ V}$

**Fig 5. Working current as a function of working voltage; typical values**

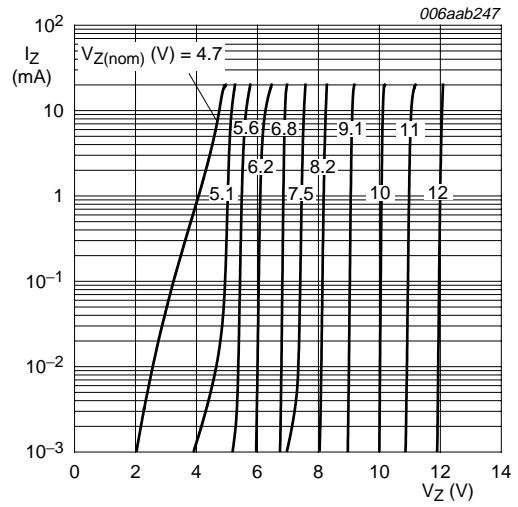

$T_j = 25\text{ }^\circ\text{C}$   
 $V_Z = 4.7\text{ V to }12\text{ V}$

**Fig 6. Working current as a function of working voltage; typical values**

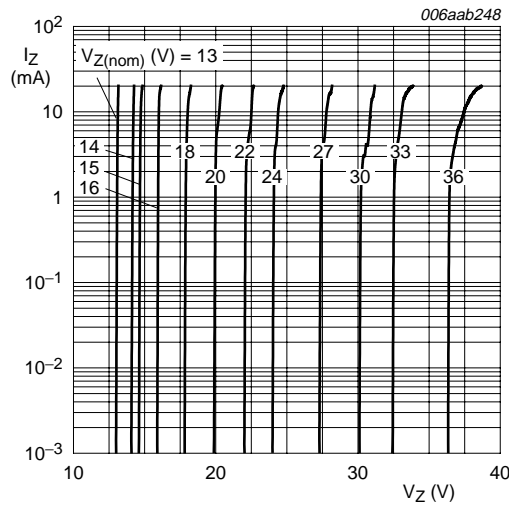

$T_j = 25\text{ }^\circ\text{C}$   
 $V_Z = 13\text{ V to }36\text{ V}$

**Fig 7. Working current as a function of working voltage; typical values**

## 8. Test information

### 8.1 Quality information

This product has been qualified in accordance with the Automotive Electronics Council (AEC) standard *Q101 - Stress test qualification for discrete semiconductors*, and is suitable for use in automotive applications.

## 9. Package outline

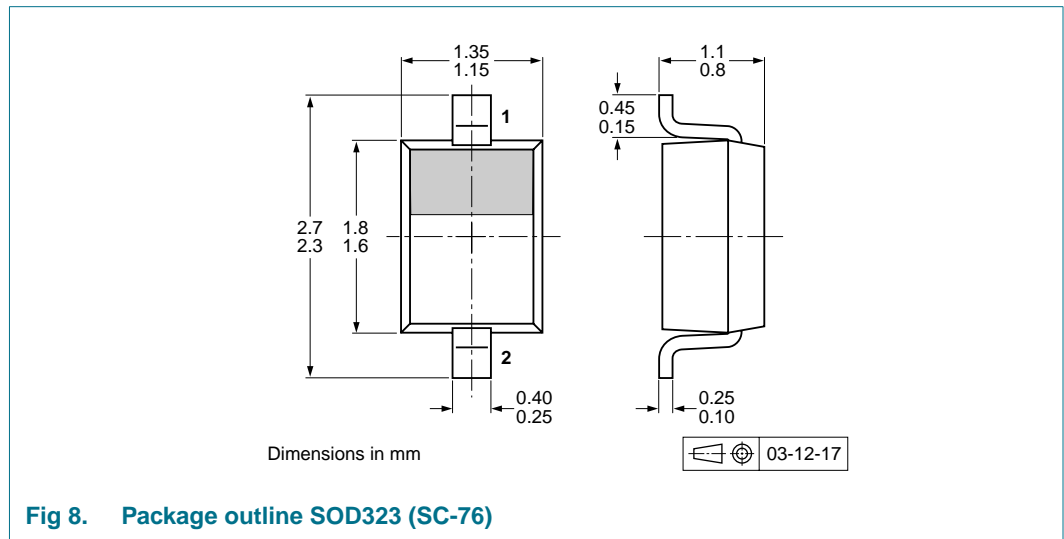

Fig 8. Package outline SOD323 (SC-76)

## 10. Packing information

**Table 10. Packing methods**

The indicated -xxx are the last three digits of the 12NC ordering code.<sup>[1]</sup>

| Type number                  | Package | Description                    | Packing quantity |       |
|------------------------------|---------|--------------------------------|------------------|-------|
|                              |         |                                | 3000             | 10000 |
| PZU2.4BA to<br>PZU36BA       | SOD323  | 4 mm pitch, 8 mm tape and reel | -115             | -135  |
| PZU2.4BA/DG to<br>PZU36BA/DG |         |                                |                  |       |

[1] For further information and the availability of packing methods, see [Section 13](#).

11. Soldering

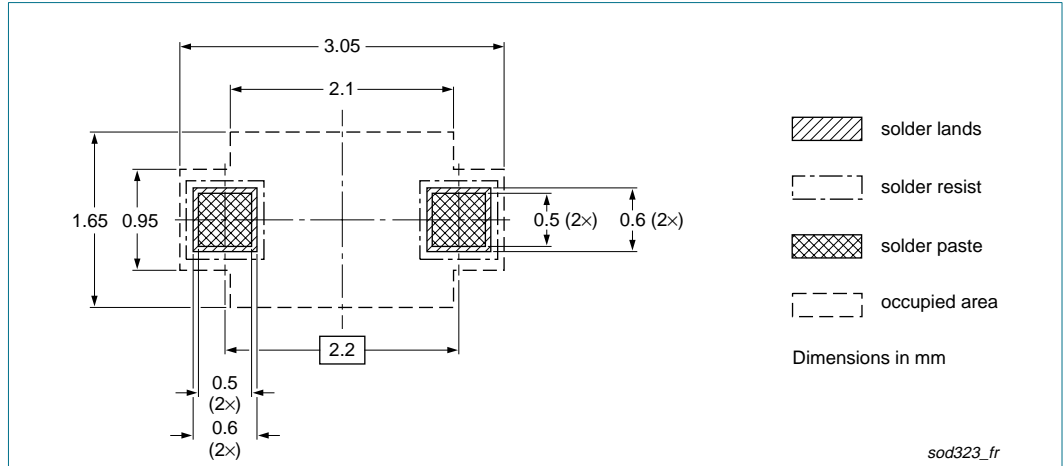

Fig 9. Reflow soldering footprint SOD323 (SC-76)

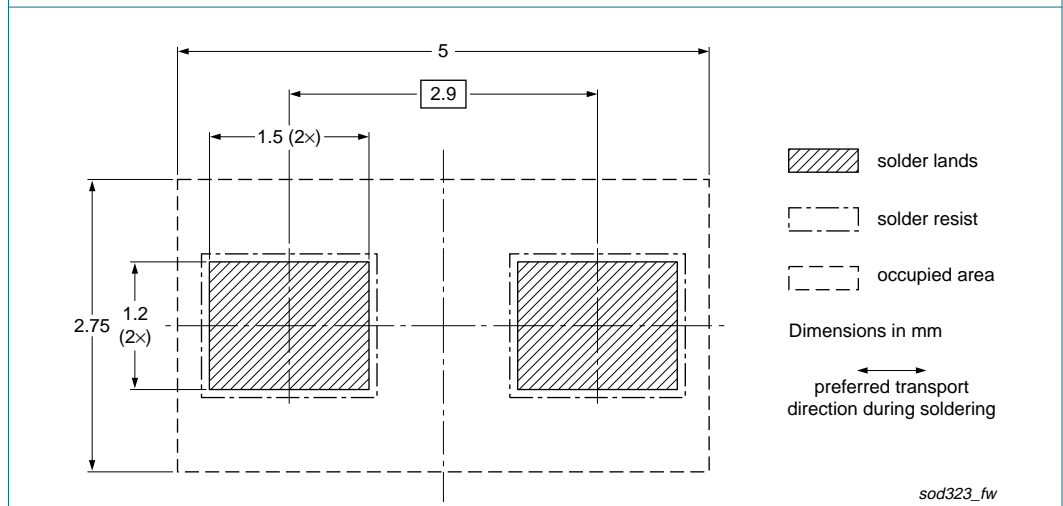

Fig 10. Wave soldering footprint SOD323 (SC-76)

## 12. Revision history

Table 11. Revision history

| Document ID  | Release date | Data sheet status  | Change notice | Supersedes |
|--------------|--------------|--------------------|---------------|------------|
| PZUXBA_SER_1 | 20080919     | Product data sheet | -             | -          |

## 13. Legal information

### 13.1 Data sheet status

| Document status <sup>[1][2]</sup> | Product status <sup>[3]</sup> | Definition  |
|-----------------------------------|-------------------------------|---|
| Objective [short] data sheet      | Development                   | This document contains data from the objective specification for product development. |
| Preliminary [short] data sheet    | Qualification                 | This document contains data from the preliminary specification.                       |
| Product [short] data sheet        | Production                    | This document contains the product specification.                                     |

[1] Please consult the most recently issued document before initiating or completing a design.

[2] The term 'short data sheet' is explained in section "Definitions".

[3] The product status of device(s) described in this document may have changed since this document was published and may differ in case of multiple devices. The latest product status information is available on the Internet at URL <http://www.nxp.com>.

### 13.2 Definitions

**Draft** — The document is a draft version only. The content is still under internal review and subject to formal approval, which may result in modifications or additions. NXP Semiconductors does not give any representations or warranties as to the accuracy or completeness of information included herein and shall have no liability for the consequences of use of such information.

**Short data sheet** — A short data sheet is an extract from a full data sheet with the same product type number(s) and title. A short data sheet is intended for quick reference only and should not be relied upon to contain detailed and full information. For detailed and full information see the relevant full data sheet, which is available on request via the local NXP Semiconductors sales office. In case of any inconsistency or conflict with the short data sheet, the full data sheet shall prevail.

### 13.3 Disclaimers

**General** — Information in this document is believed to be accurate and reliable. However, NXP Semiconductors does not give any representations or warranties, expressed or implied, as to the accuracy or completeness of such information and shall have no liability for the consequences of use of such information.

**Right to make changes** — NXP Semiconductors reserves the right to make changes to information published in this document, including without limitation specifications and product descriptions, at any time and without notice. This document supersedes and replaces all information supplied prior to the publication hereof.

**Suitability for use** — NXP Semiconductors products are not designed, authorized or warranted to be suitable for use in medical, military, aircraft, space or life support equipment, nor in applications where failure or malfunction of an NXP Semiconductors product can reasonably be expected to result in personal injury, death or severe property or environmental

damage. NXP Semiconductors accepts no liability for inclusion and/or use of NXP Semiconductors products in such equipment or applications and therefore such inclusion and/or use is at the customer's own risk.

**Applications** — Applications that are described herein for any of these products are for illustrative purposes only. NXP Semiconductors makes no representation or warranty that such applications will be suitable for the specified use without further testing or modification.

**Limiting values** — Stress above one or more limiting values (as defined in the Absolute Maximum Ratings System of IEC 60134) may cause permanent damage to the device. Limiting values are stress ratings only and operation of the device at these or any other conditions above those given in the Characteristics sections of this document is not implied. Exposure to limiting values for extended periods may affect device reliability.

**Terms and conditions of sale** — NXP Semiconductors products are sold subject to the general terms and conditions of commercial sale, as published at <http://www.nxp.com/profile/terms>, including those pertaining to warranty, intellectual property rights infringement and limitation of liability, unless explicitly otherwise agreed to in writing by NXP Semiconductors. In case of any inconsistency or conflict between information in this document and such terms and conditions, the latter will prevail.

**No offer to sell or license** — Nothing in this document may be interpreted or construed as an offer to sell products that is open for acceptance or the grant, conveyance or implication of any license under any copyrights, patents or other industrial or intellectual property rights.

**Quick reference data** — The Quick reference data is an extract of the product data given in the Limiting values and Characteristics sections of this document, and as such is not complete, exhaustive or legally binding.

### 13.4 Trademarks

Notice: All referenced brands, product names, service names and trademarks are the property of their respective owners.

## 14. Contact information

For more information, please visit: <http://www.nxp.com>

For sales office addresses, please send an email to: [salesaddresses@nxp.com](mailto:salesaddresses@nxp.com)

**15. Contents**

**1 Product profile . . . . . 1**

1.1 General description . . . . . 1

1.2 Features . . . . . 1

1.3 Applications . . . . . 1

1.4 Quick reference data . . . . . 1

**2 Pinning information . . . . . 2**

**3 Ordering information . . . . . 2**

**4 Marking . . . . . 3**

**5 Limiting values . . . . . 4**

**6 Thermal characteristics . . . . . 4**

**7 Characteristics . . . . . 4**

**8 Test information . . . . . 10**

8.1 Quality information . . . . . 10

**9 Package outline . . . . . 10**

**10 Packing information . . . . . 10**

**11 Soldering . . . . . 11**

**12 Revision history . . . . . 12**

**13 Legal information . . . . . 13**

13.1 Data sheet status . . . . . 13

13.2 Definitions . . . . . 13

13.3 Disclaimers . . . . . 13

13.4 Trademarks . . . . . 13

**14 Contact information . . . . . 13**

**15 Contents . . . . . 14**

Please be aware that important notices concerning this document and the product(s) described herein, have been included in section 'Legal information'.



© NXP B.V. 2008.

All rights reserved.

For more information, please visit: <http://www.nxp.com>

For sales office addresses, please send an email to: [salesaddresses@nxp.com](mailto:salesaddresses@nxp.com)

Date of release: 19 September 2008

Document identifier: PZUXBA\_SER\_1



Компания «ЭлектроПласт» предлагает заключение долгосрочных отношений при поставках импортных электронных компонентов на взаимовыгодных условиях!

Наши преимущества:

- Оперативные поставки широкого спектра электронных компонентов отечественного и импортного производства напрямую от производителей и с крупнейших мировых складов;
- Поставка более 17-ти миллионов наименований электронных компонентов;
- Поставка сложных, дефицитных, либо снятых с производства позиций;
- Оперативные сроки поставки под заказ (от 5 рабочих дней);
- Экспресс доставка в любую точку России;
- Техническая поддержка проекта, помощь в подборе аналогов, поставка прототипов;
- Система менеджмента качества сертифицирована по Международному стандарту ISO 9001;
- Лицензия ФСБ на осуществление работ с использованием сведений, составляющих государственную тайну;
- Поставка специализированных компонентов (Xilinx, Altera, Analog Devices, Intersil, Interpoint, Microsemi, Aeroflex, Peregrine, Syfer, Eurofarad, Texas Instrument, Miteq, Cobham, E2V, MA-COM, Hittite, Mini-Circuits, General Dynamics и др.);

Помимо этого, одним из направлений компании «ЭлектроПласт» является направление «Источники питания». Мы предлагаем Вам помощь Конструкторского отдела:

- Подбор оптимального решения, техническое обоснование при выборе компонента;
- Подбор аналогов;
- Консультации по применению компонента;
- Поставка образцов и прототипов;
- Техническая поддержка проекта;
- Защита от снятия компонента с производства.



#### Как с нами связаться

**Телефон:** 8 (812) 309 58 32 (многоканальный)

**Факс:** 8 (812) 320-02-42

**Электронная почта:** [org@eplast1.ru](mailto:org@eplast1.ru)

**Адрес:** 198099, г. Санкт-Петербург, ул. Калинина, дом 2, корпус 4, литера А.