

## Data Sheet



### Description

This 1 W Mini Power LED Light Source is a high performance energy-efficient device that can handle high thermal and high driving current. An option with an electrically isolated metal slug is also available.

The White Mini Power LED is available in the range of color temperature from 2700 K to 10000 K.

The low profile package design and ultra small footprint is suitable for a wide variety of applications especially where space and height is a constraint.

The package is compatible with reflow soldering process. To facilitate easy pick and place assembly, the LEDs are packed in EIA-compliant tape and reel.

### Features

- Available in red, amber, blue, royal blue, cyan, green, cool white, neutral white, and warm white colors
- Small footprint
- Energy efficient
- Direct heat transfer from metal slug to motherboard
- Compatible with reflow soldering process
- High current operation
- Long operation life
- Wide viewing angle
- Silicone encapsulation
- Non-ESD sensitive (threshold > 16 kV)
- MSL 1 products

### Applications

- Architectural lighting
- Garden lighting
- Decorative lighting
- Sign backlight
- Safety, exit and emergency sign lightings
- Specialty lighting such as task lighting and reading lights
- Retail display
- Commercial lighting
- Accent or marker lightings, strip, or step lightings
- Portable lightings, bicycle head lamp, torch lights
- Pathway lighting
- Street lighting
- Tunnel lighting

**CAUTION:** The customer is advised to keep the LEDs in the MBB when not in use as prolonged exposure to environment might cause the silver plated leads to tarnish, which might cause difficulties in soldering.

Figure 1 ASMT-Jx1x Package Outline Drawing

**NOTE**

1. All dimensions in millimeters.
2. Metal slug is connected to anode for electrically non-isolated option.
3. Tolerance is  $\pm 0.1$  mm unless otherwise specified.
4. Terminal finish: Ag plating.
5. Corresponding NC (No Connection) leads adjacent to anode and cathode leads can be electrically short.

## Device Selection Guide ( $T_J = 25^\circ\text{C}$ )

Part Number	Color	Luminous Flux (lm) / Radiometric Power (mW), $\Phi_V$ <sup>a, b</sup>			Test Current (mA)	Dice Technology	Electrically Isolated Metal Slug
		Min.	Typ.	Max.			
ASMT-JR10-AST01	Red	51.7	62.0	87.4	350	AllnGaP	No
ASMT-JA10-ARS01	Amber	39.8	48.0	67.2	350	AllnGaP	No
ASMT-JB11-NNQ01	Blue	18.1	24.0	39.8	350	InGaN	Yes
ASMT-JL11-NQS01	Royal Blue	435 mW	550 mW	685 mW	350	InGaN	Yes
ASMT-JC11-NTU01	Cyan	67.2	75.0	99.6	350	InGaN	Yes
ASMT-JG11-NUW01	Green	87.4	110.0	129.5	350	InGaN	Yes
ASMT-JW11-NWX01	Cool White	113.6	120.0	147.7	350	InGaN	Yes
ASMT-JN11-NWX01	Neutral White	113.6	120.0	147.7	350	InGaN	Yes
ASMT-JY11-NVW01	Warm White	99.6	105.0	129.5	350	InGaN	Yes

- a.  $\Phi_V$  is the total luminous flux/radiometric power output as measured with an integrating sphere at 25-ms mono pulse condition.  
b. Flux tolerance is  $\pm 10\%$ .

## Absolute Maximum Ratings

Parameter	AllnGaP	InGaN	InGaN Cyan	Units
DC Forward Current <sup>a</sup>	500	500	500	mA
Peak Pulsing Current <sup>b</sup>	1000	1000	1000	mA
Power Dissipation	1230	1830	1980	mW
LED Junction Temperature	125	150	150	$^\circ\text{C}$
Operating Metal Slug Temperature Range at 350 mA	-40 to +115	-40 to +135	-40 to +135	$^\circ\text{C}$
Storage Temperature Range	-40 to +120	-40 to +120	-40 to +120	$^\circ\text{C}$
Soldering Temperature	See <a href="#">Figure 29</a>			
Reverse Voltage <sup>c</sup>	Not recommended			

- a. Derate linearly based on [Figure 13](#) and [Figure 14](#) for AllnGaP and [Figure 25](#) and [Figure 26](#) for InGaN.  
b. Pulse condition duty factor = 10%, Frequency = 1 kHz.  
c. Not recommended for reverse bias operation.

## Optical Characteristics at 350 mA ( $T_J = 25^\circ\text{C}$ )

Part Number	Color	Peak Wavelength, $\lambda_{\text{PEAK}}$ (nm)	Dominant Wavelength, $\lambda_D^a$ (nm)	Viewing Angle, $2\theta_{1/2}^b$ (°)	Luminous Efficiency (lm/W)
		Typ.	Typ.	Typ.	Typ.
ASMT-JR10-AST01	Red	635	625	165	84
ASMT-JA10-ARS01	Amber	598	590	165	65
ASMT-JG11-NUW01	Green	519	525	165	98
ASMT-JC11-NTU01	Cyan	497	500	165	63
ASMT-JB11-NNQ01	Blue	454	460	165	21
ASMT-JL11-NQS01	Royal Blue	450	455	165	Not applicable

- a. The dominant wavelength,  $\lambda_D$ , is derived from the CIE Chromaticity Diagram and represents the color of the device.  
 b.  $\theta_{1/2}$  is the off-axis angle where the luminous intensity is half of the peak intensity.

Part Number	Color	Correlated Color Temperature, CCT (Kelvin)		Viewing Angle, $2\theta_{1/2}^a$ (°)	Luminous Efficiency (lm/W)
		Min.	Max.	Typ.	Typ.
ASMT-JW11-NWX01	Cool White	4500	10000	140	107
ASMT-JN11-NWX01	Neutral White	3500	4500	140	107
ASMT-JY11-NVW01	Warm White	2700	3500	140	95

- a.  $\theta_{1/2}$  is the off-axis angle where the luminous intensity is half of the peak intensity.

## Electrical Characteristic at 350 mA ( $T_J = 25^\circ\text{C}$ )

Dice Type	Forward Voltage, $V_F$ (Volts)			Thermal Resistance, $R_{\theta j-ms}$ ( $^\circ\text{C}/\text{W}$ ) <sup>a</sup>
	Min.	Typ.	Max.	Typ.
AllInGaP	1.7	2.1	2.3	9
InGaN (non-Cyan Colors)	2.8	3.2	3.5	9
InGaN Cyan	2.6	3.0	3.8	9

- a.  $R_{\theta j-ms}$  is thermal resistance from LED junction to metal slug.

## Part Numbering System

A S M T - J x<sub>1</sub> 1 x<sub>2</sub> - x<sub>3</sub> x<sub>4</sub> x<sub>5</sub> x<sub>6</sub> x<sub>7</sub>

Code	Description	Option	
x <sub>1</sub>	Color	R	Red
		A	Amber
		G	Green
		B	Blue
		L	Royal Blue
		W	Cool White
		N	Neutral White
		Y	Warm White
x <sub>2</sub>	Heat sink	0	Electrically Non Isolated
		1	Electrically Isolated
x <sub>3</sub>	Dice Type	N	InGaN
		A	AllnGaP
x <sub>4</sub>	Minimum Flux Bin	See Flux/Power Bin Limits Table	
x <sub>5</sub>	Maximum Flux Bin		
x <sub>6</sub>	Color Bin Selection	See Color Bin Selection Table	
x <sub>7</sub>	Packaging Option	0	Tube
		1	Tape and Reel

## Bin Information

### Flux/Power Bin Limit ( $x_4$ , $x_5$ )

Color	Bin ID	Luminous Flux (lm)/Radiometric Power (mW) at 350 mA	
		Min.	Max.
Blue	M	13.9	18.1
	N	18.1	23.5
	P	23.5	30.6
	Q	30.6	39.8
Other Colors	R	39.8	51.7
	S	51.7	67.2
	T	67.2	87.4
	U	87.4	99.6
	V	99.6	113.6
	W	113.6	129.5
	X	129.5	147.7
Royal Blue	M	225.0	275.0
	N	275.0	355.0
	P	355.0	435.0
	Q	435.0	515.0
	R	515.0	595.0
	S	595.0	685.0

Tolerance for each bin limit is  $\pm 10\%$ .

## Color Bin Selection (x<sub>6</sub>)

Individual reel will contain parts from one color bin selection only.

### Cool White

Selection	Bin ID
0	Full Distribution
E	VM, UM, VN, and UN
F	WM, VM, WN, and VN
G	XM, WM, XN, and WN
H	UN, VN, U0, and V0
J	WN, VN, W0, and V0
K	XN, WN, X0, and W0
L	V0, U0, VP, and UP
M	W0, V0, WP, VP, and WQ
N	X0, W0, XP, WP, and WQ
P	Y0
Q	YA

### Warm White

Selection	Bin ID
0	Full Distribution
E	NM, MM, N1, and M1
F	PM, NM, P1, and N1
G	QM, PM, Q1, and P1
H	M1, N1, M0, and N0
J	P1, N1, P0, and N0
K	Q1, P1, Q0, and P0
L	N0, M0, NA, and MA
M	P0, N0, PA, and NA
N	Q0, P0, QA, and PA

### Neutral White

Selection	Bin ID
0	Full Distribution
E	SM, RM, S1, and R1
F	TM, SM, TN, and S1
G	S1, R1, S0, and R0
H	TN, S1, T0, and S0
J	S0, R0, SA, and RA
K	T0, S0, TP, and SA

### Other Colors

Selection	Bin ID
0	Full Distribution
Z	A and B
Y	B and C
W	C and D
V	D and E
Q	A, B, and C
P	B, C, and D
N	C, D, and E
M	D, E, and F

Figure 2 Color Bin Structure for Cool White

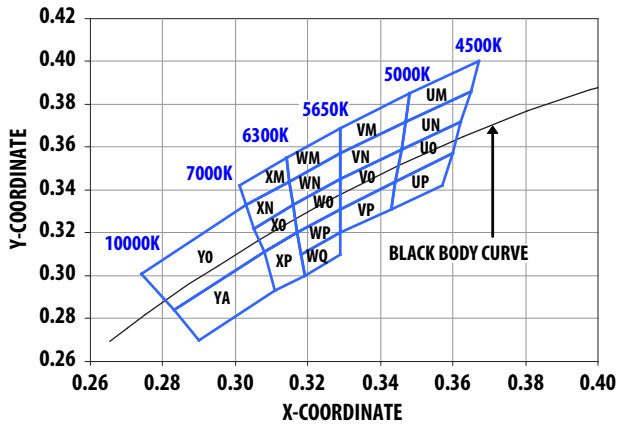
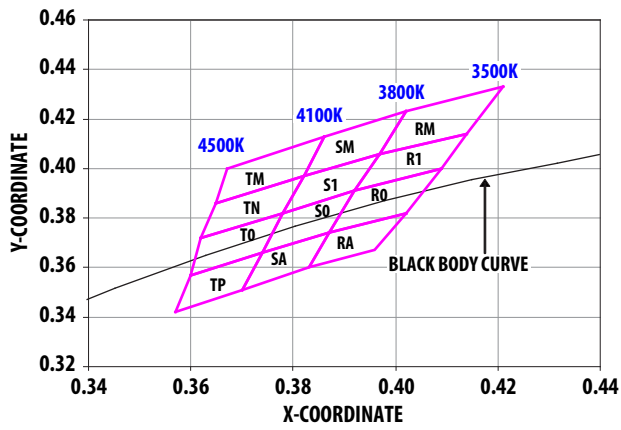


Figure 3 Color Bin Structure for Warm White



Figure 4 Color Bin Structure for Neutral White





## Color Bin Limits

Cool White	Color Limits (Chromaticity Coordinates)				
Bin UM	x	0.365	0.348	0.347	0.367
	y	0.386	0.385	0.372	0.400
Bin UN	x	0.365	0.362	0.346	0.347
	y	0.386	0.372	0.359	0.372
Bin UO	x	0.362	0.360	0.344	0.346
	y	0.372	0.357	0.344	0.359
Bin UP	x	0.360	0.357	0.343	0.344
	y	0.357	0.342	0.311	0.344
Bin VM	x	0.329	0.329	0.348	0.347
	y	0.357	0.369	0.385	0.372
Bin VN	x	0.329	0.329	0.347	0.346
	y	0.345	0.357	0.372	0.359
Bin VO	x	0.329	0.329	0.346	0.344
	y	0.331	0.345	0.359	0.344
Bin VP	x	0.329	0.344	0.343	0.329
	y	0.331	0.344	0.331	0.320
Bin WM	x	0.329	0.329	0.315	0.314
	y	0.369	0.357	0.344	0.355
Bin WN	x	0.329	0.316	0.315	0.329
	y	0.345	0.333	0.344	0.357
Bin WO	x	0.329	0.329	0.317	0.316
	y	0.345	0.331	0.320	0.333
Bin WP	x	0.329	0.329	0.318	0.317
	y	0.331	0.320	0.310	0.320
Bin WQ	x	0.329	0.329	0.319	0.318
	y	0.320	0.310	0.300	0.310
Bin XM	x	0.301	0.314	0.315	0.303
	y	0.342	0.355	0.344	0.333
Bin XN	x	0.305	0.303	0.315	0.316
	y	0.322	0.333	0.344	0.333
Bin XO	x	0.308	0.305	0.316	0.317
	y	0.311	0.322	0.333	0.320
Bin XP	x	0.308	0.317	0.319	0.311
	y	0.311	0.320	0.300	0.293
Bin YO	x	0.308	0.283	0.274	0.303
	y	0.311	0.284	0.301	0.333
Bin YA	x	0.308	0.311	0.290	0.283
	y	0.311	0.293	0.270	0.284

Tolerance:  $\pm 0.01$ 

Warm White	Color Limits (Chromaticity Coordinates)				
Bin MM	x	0.471	0.460	0.473	0.486
	y	0.451	0.430	0.432	0.455
Bin M1	x	0.460	0.453	0.467	0.473
	y	0.430	0.416	0.419	0.432
Bin M0	x	0.453	0.444	0.459	0.467
	y	0.416	0.399	0.403	0.419
Bin MA	x	0.459	0.444	0.436	0.451
	y	0.403	0.399	0.384	0.389
Bin NM	x	0.454	0.444	0.460	0.471
	y	0.446	0.426	0.430	0.451
Bin N1	x	0.444	0.438	0.453	0.460
	y	0.426	0.412	0.416	0.430
Bin N0	x	0.438	0.429	0.444	0.453
	y	0.412	0.394	0.399	0.416
Bin NA	x	0.444	0.429	0.422	0.436
	y	0.399	0.394	0.379	0.384
Bin PM	x	0.438	0.430	0.444	0.454
	y	0.440	0.421	0.426	0.446
Bin P1	x	0.430	0.424	0.438	0.444
	y	0.421	0.407	0.412	0.426
Bin P0	x	0.424	0.416	0.429	0.438
	y	0.407	0.389	0.394	0.412
Bin PA	x	0.429	0.416	0.410	0.422
	y	0.394	0.389	0.374	0.379
Bin QM	x	0.421	0.414	0.430	0.438
	y	0.433	0.414	0.421	0.440
Bin Q1	x	0.414	0.409	0.424	0.430
	y	0.414	0.400	0.407	0.421
Bin Q0	x	0.409	0.402	0.416	0.424
	y	0.400	0.382	0.389	0.407
Bin QA	x	0.416	0.402	0.396	0.410
	y	0.389	0.382	0.367	0.374

Tolerance:  $\pm 0.01$

Neutral White	Color Limits (Chromaticity Coordinates)				
Bin RM	x	0.421	0.414	0.397	0.402
	y	0.433	0.414	0.406	0.423
Bin R1	x	0.414	0.409	0.392	0.397
	y	0.414	0.400	0.391	0.406
Bin R0	x	0.392	0.387	0.402	0.409
	y	0.391	0.374	0.382	0.400
Bin RA	x	0.387	0.383	0.396	0.402
	y	0.374	0.360	0.367	0.382
Bin SM	x	0.402	0.397	0.382	0.386
	y	0.423	0.406	0.397	0.413
Bin S1	x	0.397	0.392	0.378	0.382
	y	0.406	0.391	0.382	0.397
Bin S0	x	0.392	0.387	0.374	0.378
	y	0.391	0.374	0.366	0.382
Bin SA	x	0.387	0.383	0.370	0.374
	y	0.374	0.360	0.351	0.366
Bin TM	x	0.386	0.382	0.365	0.367
	y	0.413	0.397	0.386	0.400
Bin TN	x	0.382	0.378	0.362	0.365
	y	0.397	0.382	0.372	0.386
Bin T0	x	0.378	0.374	0.360	0.362
	y	0.382	0.366	0.357	0.372
Bin TP	x	0.374	0.370	0.357	0.360
	y	0.366	0.351	0.342	0.357

Tolerance:  $\pm 0.01$ **Packaging Option (x<sub>7</sub>)**

Selection	Option
1	Tape and Reel

Color	Bin ID	Dominant Wavelength (nm) at 350 mA	
		Min.	Max.
Red	—	620.0	635.0
Amber	B	587.0	589.5
	C	589.5	592.0
	D	592.0	594.5
	E	594.5	597.0
Blue	A	455.0	460.0
	B	460.0	465.0
	C	465.0	470.0
	D	470.0	475.0
Cyan	C	490.0	495.0
	D	495.0	500.0
	E	500.0	505.0
	F	505.0	510.0
	G	510.0	515.0
	H	515.0	520.0
Green	A	515.0	520.0
	B	520.0	525.0
	C	525.0	530.0
	D	530.0	535.0

Tolerance:  $\pm 1$  nm

Color	Bin ID	Peak Wavelength (nm) at 350 mA	
		Min.	Max.
Royal Blue	C	440.0	445.0
	D	445.0	450.0
	E	450.0	455.0
	F	455.0	460.0

Tolerance:  $\pm 2$  nm

---

## Example

### ASMT-JY11-NVW01

- ASMT-JY11-Nxxxx – Warm White, InGaN, Electrically isolated Heat Sink
- $X_4 = V$  – Minimum Flux Bin V
- $X_5 = W$  – Maximum Flux Bin W
- $X_6 = 0$  – Full Distribution
- $X_7 = 1$  – Tape and Reel Option

# AlInGaP

Figure 5 Relative Intensity vs. Wavelength for Red and Amber



Figure 6 Relative Luminous Flux vs. Mono Pulse Current

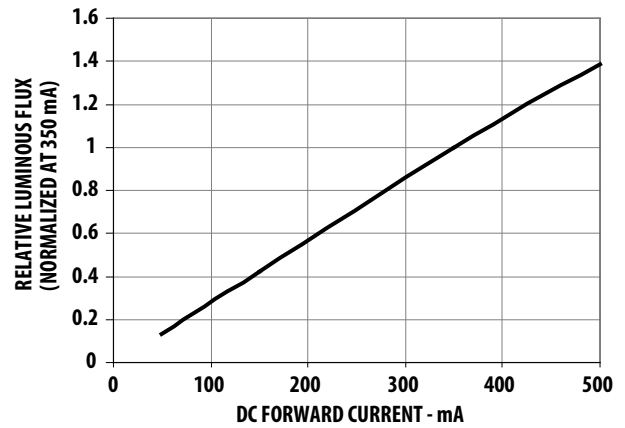


Figure 7 Forward Current vs. Forward Voltage

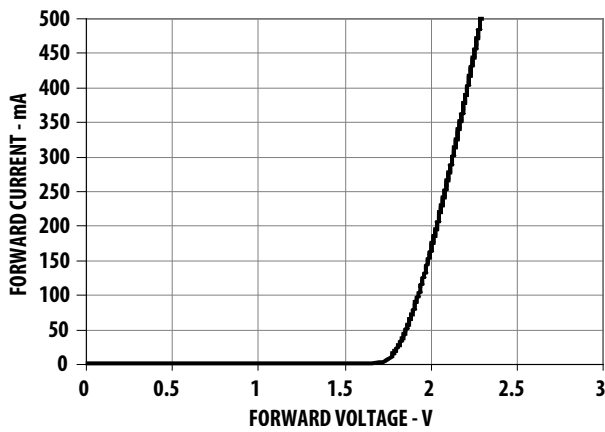


Figure 8 Radiation Pattern for Red and Amber

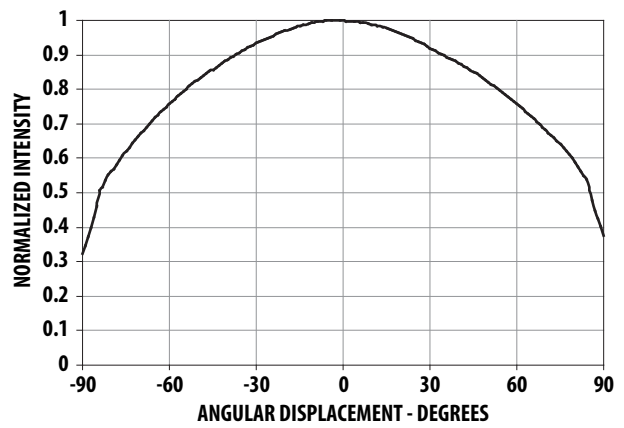


Figure 9 Maximum Pulse Current vs. Ambient Temperature. Derated based on  $T_A = 25^\circ\text{C}$ ,  $R_{\theta J-A} = 50^\circ\text{C/W}$ .

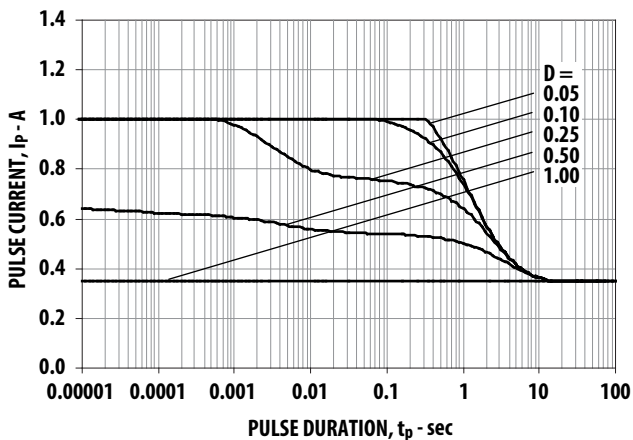
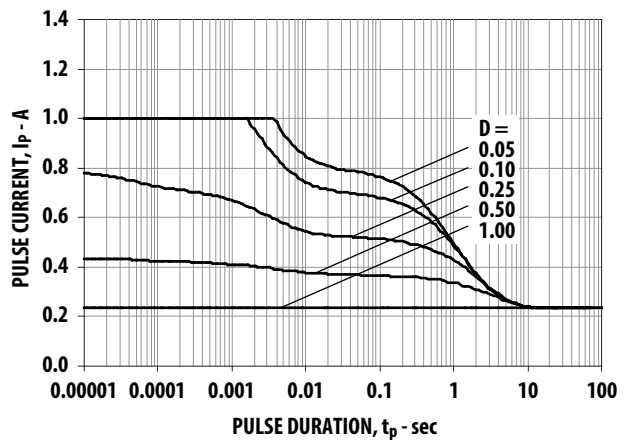
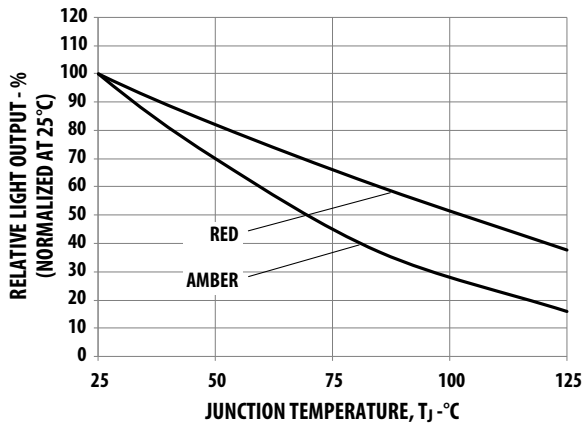


Figure 10 Maximum Pulse Current vs. Ambient Temperature. Derated based on  $T_A = 85^\circ\text{C}$ ,  $R_{\theta J-A} = 50^\circ\text{C/W}$ .

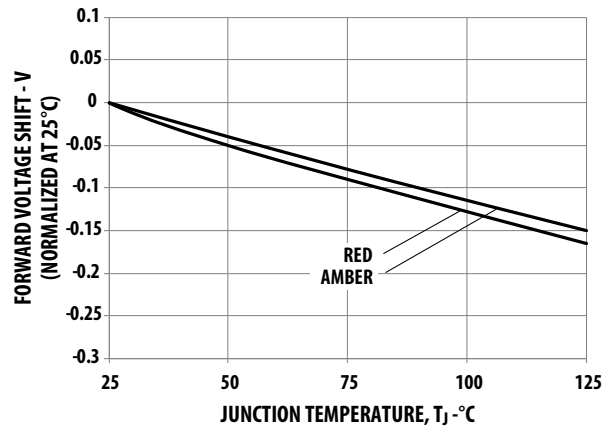


# AllnGaP

**Figure 11 Relative Light Output vs. Junction Temperature**



**Figure 12 Forward Voltage Shift vs. Junction Temperature**



**Figure 13 Maximum Forward Current vs. Ambient Temperature. Derated based on  $T_{JMAX} = 125^\circ\text{C}$ ,  $R_{\theta J-A} = 30^\circ\text{C/W}$ ,  $40^\circ\text{C/W}$ , and  $50^\circ\text{C/W}$ .**

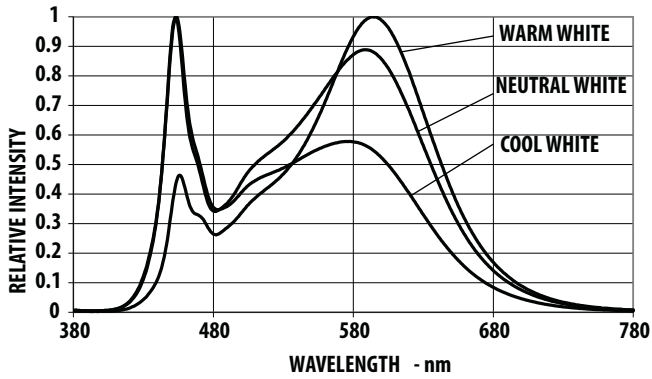


**Figure 14 Maximum Forward Current vs. Metal Slug Temperature. Derated based on  $T_{JMAX} = 125^\circ\text{C}$ ,  $R_{\theta J-MS} = 9^\circ\text{C/W}$ .**

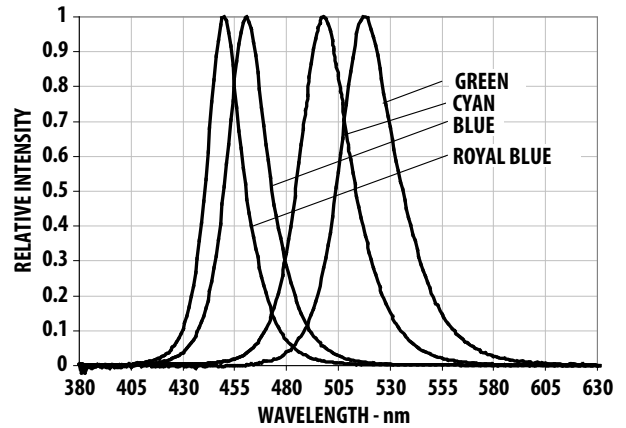


# InGaN

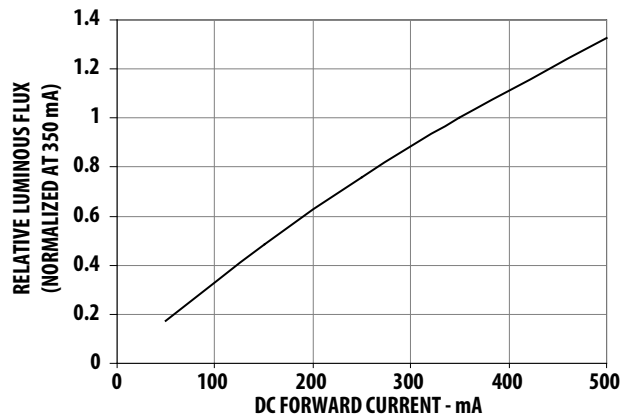
**Figure 15** Relative Intensity vs. Wavelength for Cool, Neutral, and Warm White



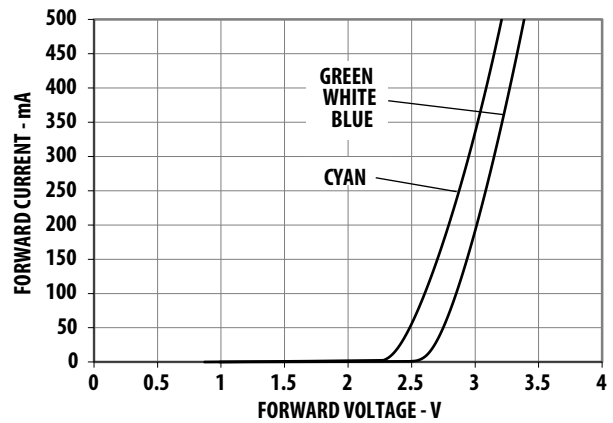
**Figure 16** Relative Intensity vs. Wavelength for Blue, Royal Blue, Cyan, and Green



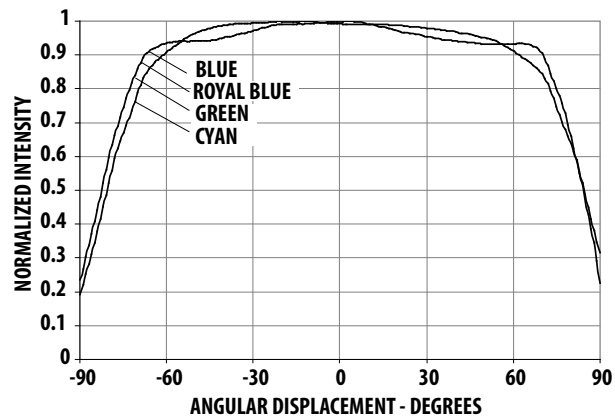
**Figure 17** Relative Luminous Flux vs. Mono Pulse Current



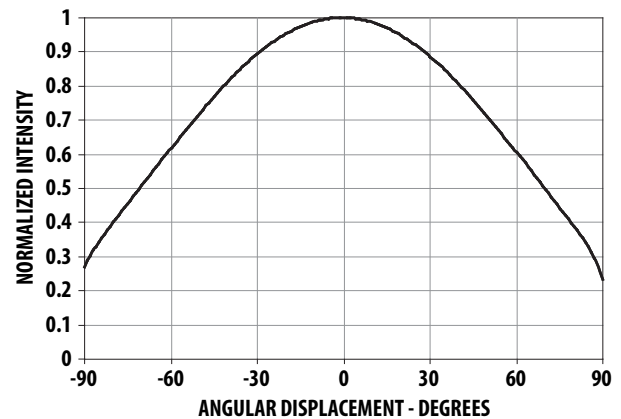
**Figure 18** Forward Current vs. Forward Voltage



**Figure 19** Radiation Pattern for Blue, Royal Blue, Cyan, and Green

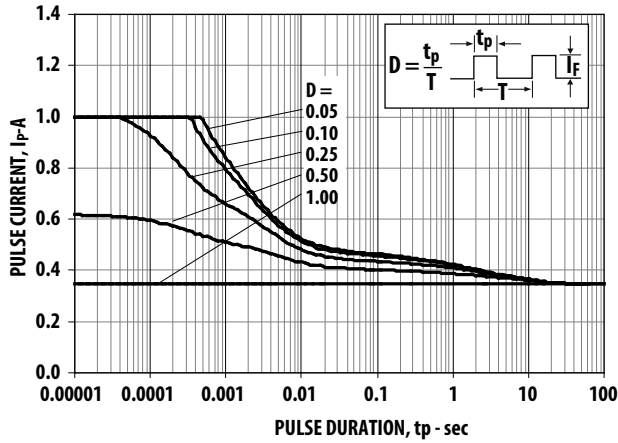


**Figure 20** Radiation Pattern for Cool White, Neutral White, and Warm White

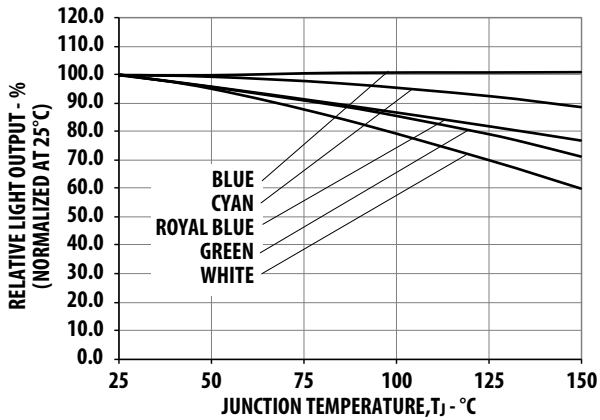


# InGaN

**Figure 21 Maximum Pulse Current vs. Ambient Temperature.**  
Derated based on  $T_A = 25^\circ\text{C}$ ,  $R_{\theta J-A} = 50^\circ\text{C/W}$ .



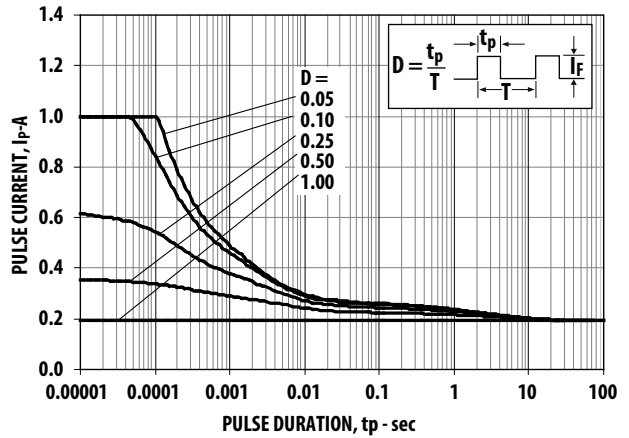
**Figure 23 Relative Light Output vs. Junction Temperature**



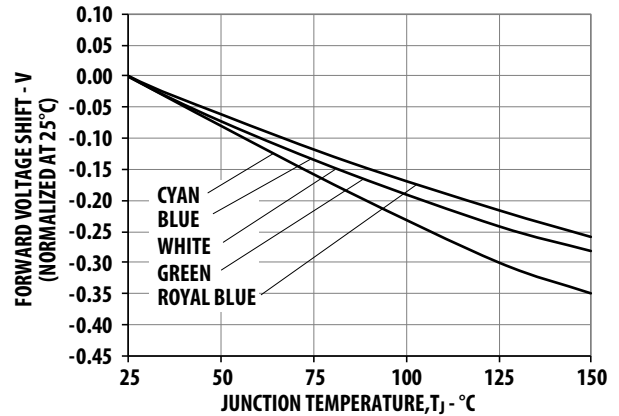
**Figure 25 Maximum Forward Current vs. Ambient Temperature.**  
Derated based on  $T_{JMAX} = 150^\circ\text{C}$ ,  $R_{\theta J-A} = 30^\circ\text{C/W}$ ,  $40^\circ\text{C/W}$  and  $50^\circ\text{C/W}$ .



**Figure 22 Maximum Pulse Current vs. Ambient Temperature.**  
Derated based on  $T_A = 85^\circ\text{C}$ ,  $R_{\theta J-A} = 50^\circ\text{C/W}$ .



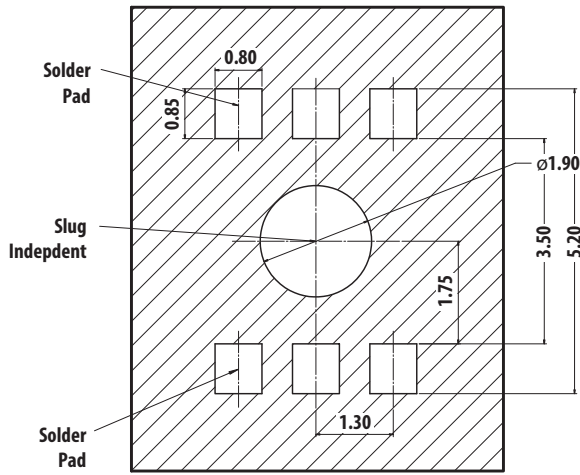
**Figure 24 Forward Voltage Shift vs. Junction Temperature**



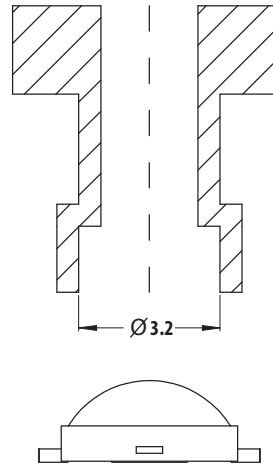
**Figure 26 Maximum Forward Current vs. Metal Slug Temperature.**  
Derated based on  $T_{JMAX} = 150^\circ\text{C}$ ,  $R_{\theta J-MS} = 9^\circ\text{C/W}$ .



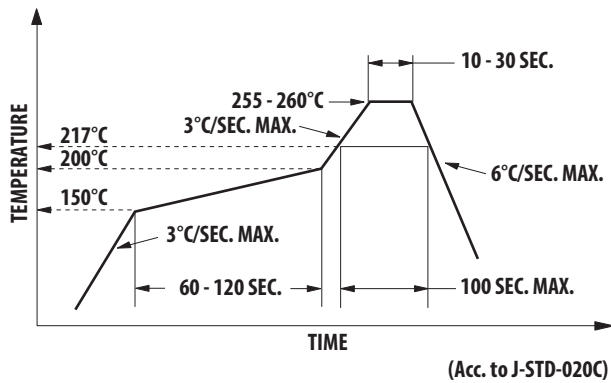
**Figure 27 Recommended Soldering Land Pattern**



**Figure 28 Recommended Pick and Place Nozzle Tip. Inner diameter = 3.2 mm.**



**Figure 29 Recommended Soldering Profile**



**NOTE** For detailed information on reflow soldering of Broadcom surface-mount LEDs, refer to Broadcom Application Note AN1060, *Surface Mounting SMT LED Indicator Components*.



# Tape and Reel – Option 1

Figure 30 Carrier Tape Dimensions



**NOTE** All dimensions are in millimeters.

**Figure 31 Reel Dimensions****NOTE**

1. Empty component pockets sealed with top cover tape.
2. 250 or 500 pieces per reel.
3. Drawing not to scale.
4. All dimensions are in millimeters.

**Figure 32 Reeling Orientation**

**DISCLAIMER:** Broadcom's products and software are not specifically designed, manufactured, or authorized for sale as parts, components, or assemblies for the planning, construction, maintenance, or direct operation of a nuclear facility or for use in medical devices or applications. The customer is solely responsible, and waives all rights to make claims against Broadcom or its suppliers, for all loss, damage, expense, or liability in connection with such use.

---

For product information and a complete list of distributors, please go to our web site: [www.broadcom.com](http://www.broadcom.com).

Broadcom, the pulse logo, Connecting everything, Avago Technologies, Avago, and the A logo are among the trademarks of Broadcom and/or its affiliates in the United States, certain other countries and/or the EU.

Copyright © 2015–2017 by Broadcom. All Rights Reserved.

The term "Broadcom" refers to Broadcom Limited and/or its subsidiaries. For more information, please visit [www.broadcom.com](http://www.broadcom.com).

Broadcom reserves the right to make changes without further notice to any products or data herein to improve reliability, function, or design.

Information furnished by Broadcom is believed to be accurate and reliable. However, Broadcom does not assume any liability arising out of the application or use of this information, nor the application or use of any product or circuit described herein, neither does it convey any license under its patent rights nor the rights of others.

AV02-1770EN – May 5, 2017





Компания «ЭлектроПласт» предлагает заключение долгосрочных отношений при поставках импортных электронных компонентов на взаимовыгодных условиях!

Наши преимущества:

- Оперативные поставки широкого спектра электронных компонентов отечественного и импортного производства напрямую от производителей и с крупнейших мировых складов;
- Поставка более 17-ти миллионов наименований электронных компонентов;
- Поставка сложных, дефицитных, либо снятых с производства позиций;
- Оперативные сроки поставки под заказ (от 5 рабочих дней);
- Экспресс доставка в любую точку России;
- Техническая поддержка проекта, помощь в подборе аналогов, поставка прототипов;
- Система менеджмента качества сертифицирована по Международному стандарту ISO 9001;
- Лицензия ФСБ на осуществление работ с использованием сведений, составляющих государственную тайну;
- Поставка специализированных компонентов (Xilinx, Altera, Analog Devices, Intersil, Interpoint, Microsemi, Aeroflex, Peregrine, Syfer, Eurofarad, Texas Instrument, Miteq, Cobham, E2V, MA-COM, Hittite, Mini-Circuits, General Dynamics и др.);

Помимо этого, одним из направлений компании «ЭлектроПласт» является направление «Источники питания». Мы предлагаем Вам помощь Конструкторского отдела:

- Подбор оптимального решения, техническое обоснование при выборе компонента;
- Подбор аналогов;
- Консультации по применению компонента;
- Поставка образцов и прототипов;
- Техническая поддержка проекта;
- Защита от снятия компонента с производства.



#### Как с нами связаться

**Телефон:** 8 (812) 309 58 32 (многоканальный)

**Факс:** 8 (812) 320-02-42

**Электронная почта:** [org@eplast1.ru](mailto:org@eplast1.ru)

**Адрес:** 198099, г. Санкт-Петербург, ул. Калинина, дом 2, корпус 4, литера А.