

### Features

- Ideally Suited for Automatic Insertion
- Epitaxial Planar Die Construction
- For Switching, AF Driver and Amplifier Applications
- Complementary NPN Types Available (BC817-xxW)
- Lead Free By Design/RoHS Compliant (Note 1)
- "Green" Device (Note 2)

### Mechanical Data

Case: SOT-323  
 Case Material: Molded Plastic. "Green" Molding Compound.  
 UL Flammability Classification Rating 94V-0  
 Moisture Sensitivity: Level 1 per J-STD-020C  
 Terminals: Finish – Matte Tin annealed over Alloy 42 leadframe. Solderable per MIL-STD-202, Method 208  
 Pin Connections: See Diagram

Marking:

P/N	Marking
BC807-16W	K5A
BC807-25W	K5B
BC807-40W	K5C

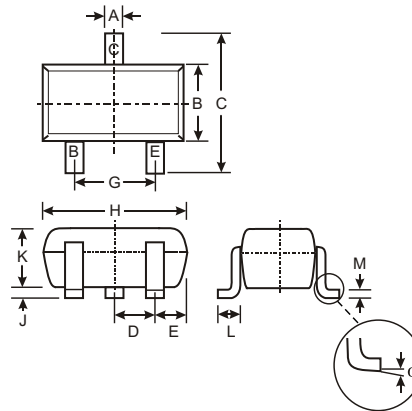

SOT-323		
Dim	Min	Max
A	0.25	0.40
B	1.15	1.35
C	2.00	2.20
D	0.65 Nominal	
E	0.30	0.40
G	1.20	1.40
H	1.80	2.20
J	0.0	0.10
K	0.90	1.00
L	0.25	0.40
M	0.10	0.18
	0	8
All Dimensions in mm		

Ordering & Date Code Information: See Page 3

Approximate Weight: 0.006 grams

### Maximum Ratings @ T<sub>A</sub> = 25°C unless otherwise specified

Characteristic	Symbol	Value	Unit
Collector-Emitter Voltage	V <sub>CEO</sub>	-45	V
Emitter-Base Voltage	V <sub>EBO</sub>	-5.0	V
Collector Current	I <sub>C</sub>	-500	mA
Peak Collector Current	I <sub>CM</sub>	-1000	mA
Peak Emitter Current	I <sub>EM</sub>	-1000	mA
Power Dissipation at T <sub>SB</sub> = 50°C (Note 3)	P <sub>d</sub>	200	mW
Thermal Resistance, Junction to Ambient Air (Note 3)	R <sub>JA</sub>	625	°C/W
Operating and Storage Temperature Range	T <sub>j</sub> , T <sub>STG</sub>	-65 to +150	°C

### Electrical Characteristics @ T<sub>A</sub> = 25°C unless otherwise specified

Characteristic (Note 4)	Symbol	Min	Typ	Max	Unit	Test Condition
DC Current Gain	h <sub>FE</sub>	100	—	250	—	V <sub>CE</sub> = -1.0V, I <sub>C</sub> = -100mA
		160		400		
		250		600		
		60		—		
Current Gain Group -16	h <sub>FE</sub>	100	—	—	—	V <sub>CE</sub> = -1.0V, I <sub>C</sub> = -300mA
		100		—		
		170		—		
Collector-Emitter Saturation Voltage	V <sub>CE(SAT)</sub>	—	—	-0.7	V	I <sub>C</sub> = -500mA, I <sub>B</sub> = -50mA
Base-Emitter Voltage	V <sub>BE</sub>	—	—	-1.2	V	V <sub>CE</sub> = -1.0V, I <sub>C</sub> = -300mA
Collector-Emitter Cutoff Current	I <sub>CES</sub>	—	—	-100 -5.0	nA μA	V <sub>CE</sub> = -45V V <sub>CE</sub> = -25V, T <sub>j</sub> = 150°C
Emitter-Base Cutoff Current	I <sub>EBO</sub>	—	—	-100	nA	V <sub>EB</sub> = -4.0V
Gain Bandwidth Product	f <sub>T</sub>	100	—	—	MHz	V <sub>CE</sub> = -5.0V, I <sub>C</sub> = -10mA, f = 50MHz
Collector-Base Capacitance	C <sub>CBO</sub>	—	—	12	pF	V <sub>CB</sub> = -10V, f = 1.0MHz

- Notes:
- No purposefully added lead.
  - Diodes Inc's "Green" policy can be found on our website at [http://www.diodes.com/products/lead\\_free/index.php](http://www.diodes.com/products/lead_free/index.php).
  - Device mounted on FR-4 PCB, 1 inch x 0.85 inch x 0.062 inch; pad layout as shown on Diodes Inc. suggested pad layout document AP02001, which can be found on our website at <http://www.diodes.com/datasheets/ap02001.pdf>.
  - Short duration pulse test used to minimize self-heating effect.

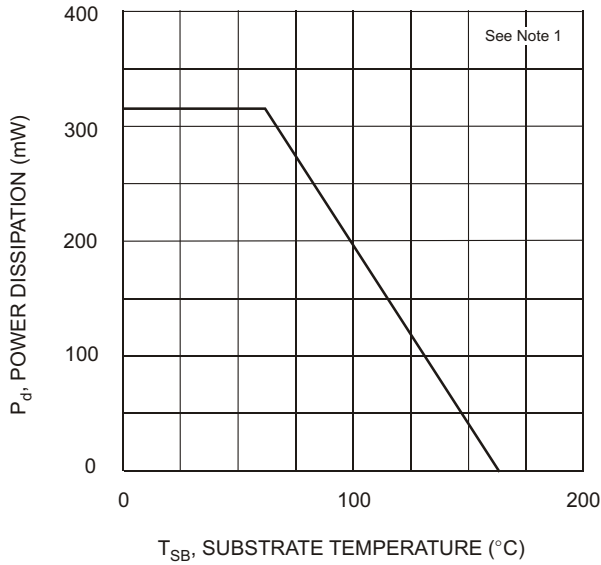

Fig. 1, Power Derating Curve

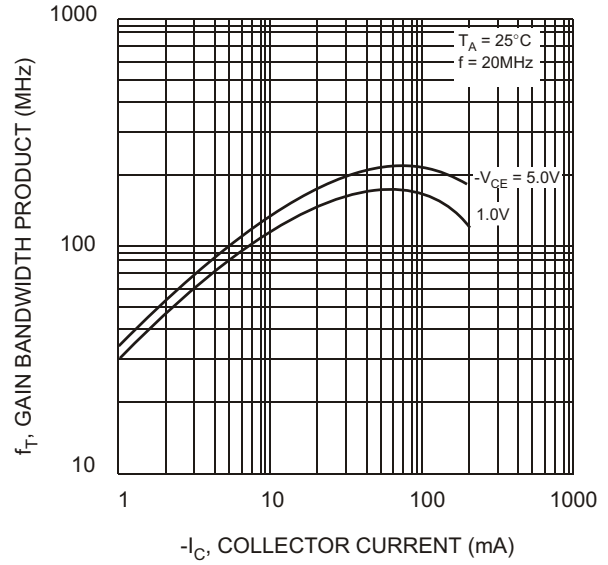

Fig. 2, Gain-Bandwidth Product vs Collector Current

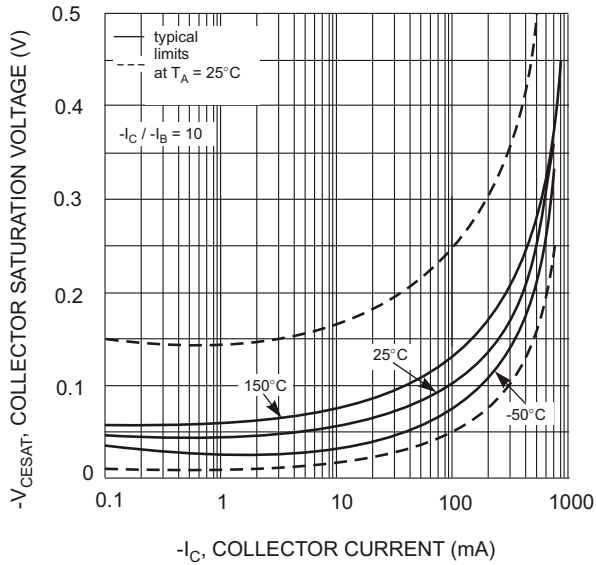

Fig. 3, Collector Sat. Voltage vs Collector Current

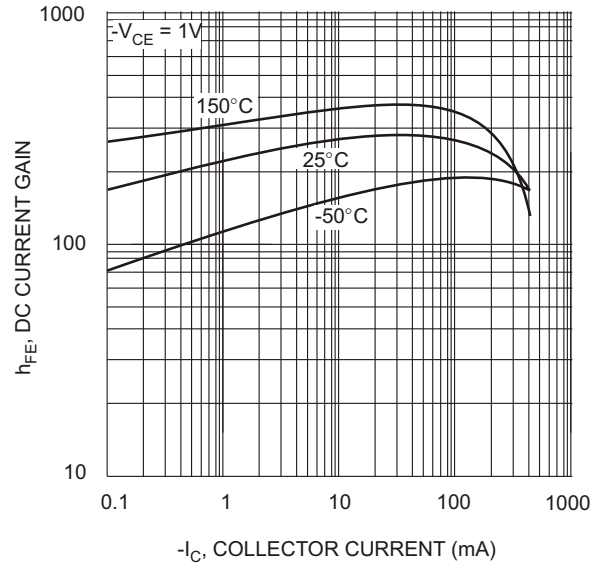

Fig. 4, DC Current Gain vs Collector Current

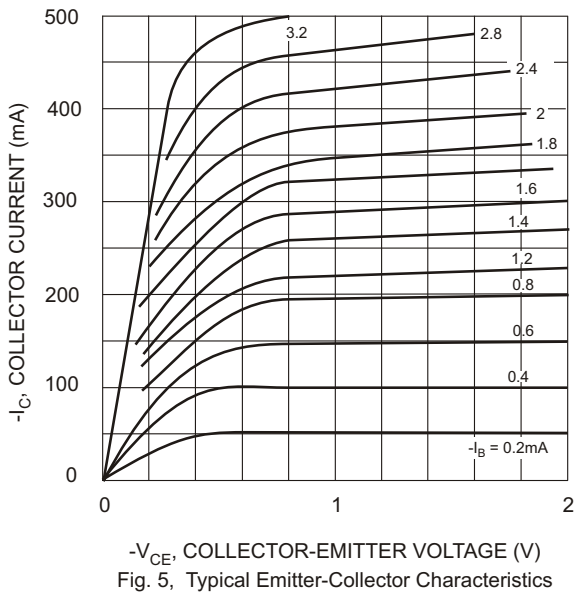

Fig. 5, Typical Emitter-Collector Characteristics

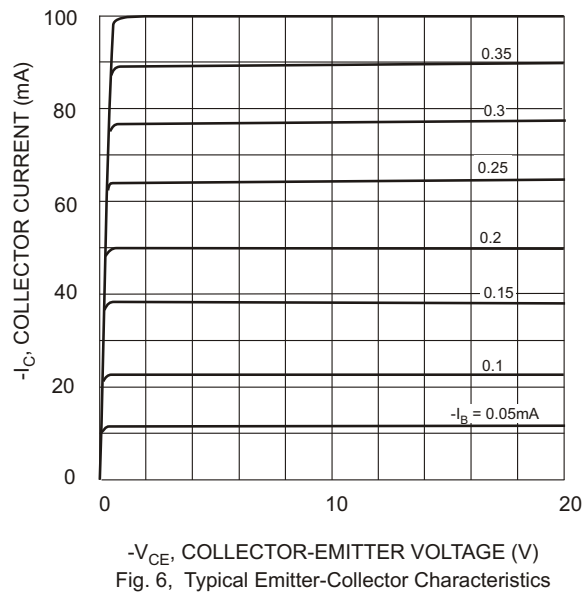

Fig. 6, Typical Emitter-Collector Characteristics

## Ordering Information (Note 5)

Device*	Packaging	Shipping
BC807-xxW-7	SOT-323	3000/Tape & Reel

Notes: 5. For Packaging Details, go to our website at <http://www.diodes.com/datasheets/ap02007.pdf>.  
 \* xx = gain group, e.g. BC807-16W-7.

## Marking Information

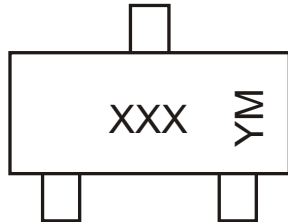

XXX = Product Type Marking Code (See Page 1), e.g. K5A = BC807-16  
 YM = Date Code Marking  
 Y = Year ex: S = 2005  
 M = Month ex: 9 = September

Date Code Key

Year	2004	2005	2006	2007	2008	2009	2010	2011	2012
Code	R	S	T	U	V	W	X	Y	Z

Month	Jan	Feb	March	Apr	May	Jun	Jul	Aug	Sep	Oct	Nov	Dec
Code	1	2	3	4	5	6	7	8	9	O	N	D

### IMPORTANT NOTICE

Diodes Incorporated and its subsidiaries reserve the right to make modifications, enhancements, improvements, corrections or other changes without further notice to any product herein. Diodes Incorporated does not assume any liability arising out of the application or use of any product described herein; neither does it convey any license under its patent rights, nor the rights of others. The user of products in such applications shall assume all risks of such use and will agree to hold Diodes Incorporated and all the companies whose products are represented on our website, harmless against all damages.

### LIFE SUPPORT

Diodes Incorporated products are not authorized for use as critical components in life support devices or systems without the expressed written approval of the President of Diodes Incorporated.



Компания «ЭлектроПласт» предлагает заключение долгосрочных отношений при поставках импортных электронных компонентов на взаимовыгодных условиях!

Наши преимущества:

- Оперативные поставки широкого спектра электронных компонентов отечественного и импортного производства напрямую от производителей и с крупнейших мировых складов;
- Поставка более 17-ти миллионов наименований электронных компонентов;
- Поставка сложных, дефицитных, либо снятых с производства позиций;
- Оперативные сроки поставки под заказ (от 5 рабочих дней);
- Экспресс доставка в любую точку России;
- Техническая поддержка проекта, помощь в подборе аналогов, поставка прототипов;
- Система менеджмента качества сертифицирована по Международному стандарту ISO 9001;
- Лицензия ФСБ на осуществление работ с использованием сведений, составляющих государственную тайну;
- Поставка специализированных компонентов (Xilinx, Altera, Analog Devices, Intersil, Interpoint, Microsemi, Aeroflex, Peregrine, Syfer, Eurofarad, Texas Instrument, Miteq, Cobham, E2V, MA-COM, Hittite, Mini-Circuits, General Dynamics и др.);

Помимо этого, одним из направлений компании «ЭлектроПласт» является направление «Источники питания». Мы предлагаем Вам помощь Конструкторского отдела:

- Подбор оптимального решения, техническое обоснование при выборе компонента;
- Подбор аналогов;
- Консультации по применению компонента;
- Поставка образцов и прототипов;
- Техническая поддержка проекта;
- Защита от снятия компонента с производства.



#### Как с нами связаться

**Телефон:** 8 (812) 309 58 32 (многоканальный)

**Факс:** 8 (812) 320-02-42

**Электронная почта:** [org@eplast1.ru](mailto:org@eplast1.ru)

**Адрес:** 198099, г. Санкт-Петербург, ул. Калинина, дом 2, корпус 4, литера А.