

## FEATURES

- **SO Package with Standard Pinout**
- **Supply Current per Amplifier: 17 $\mu$ A Max**
- **Offset Voltage: 70 $\mu$ V Max**
- Offset Current: 250pA Max
- Input Bias Current: 5nA Max
- Voltage Noise: 0.9 $\mu$ V<sub>P-P</sub>, 0.1Hz to 10Hz
- Current Noise: 1.5pA<sub>P-P</sub>, 0.1Hz to 10Hz
- Offset Voltage Drift: 0.5 $\mu$ V/°C
- Gain Bandwidth Product: 85kHz
- Slew Rate: 0.04V/ $\mu$ s
- Single Supply Operation
  - Input Voltage Range Includes Ground
  - Output Swings to Ground while Sinking Current
  - No Pull-Down Resistors Needed
- Output Sources and Sinks 5mA Load Current

## APPLICATIONS

- Battery- or Solar-Powered Systems
  - Portable Instrumentation
  - Remote Sensor Amplifier
  - Satellite Circuitry
- Micropower Sample-and-Hold
- Thermocouple Amplifier
- Micropower Filters

LT, LT, LTC, LTM, Linear Technology and the Linear logo are registered trademarks of Linear Technology Corporation. All other trademarks are the property of their respective owners.

## DESCRIPTION

The LT<sup>®</sup>2178 is a micropower dual op amp in a surface mount standard 8-pin configuration, the LT2179 is a micropower quad op amp offered in a surface mount 14-pin package. Both devices are optimized for single supply operation at 5V. Specifications are also provided at  $\pm 15$ V supply.

The extremely low supply current is combined with true precision specifications: offset voltage is 30 $\mu$ V and offset current is 50pA. Both offset parameters have low drift with temperature. The 1.5pA<sub>P-P</sub> current noise and picoampere offset current permit the use the megohm level source resistors without introducing serious errors. Voltage noise, at 0.9 $\mu$ V<sub>P-P</sub>, is remarkably low considering the low supply current.

The LT2178/LT2179 can be operated from a single supply (as low as one lithium-cell or two NiCd batteries). The input range goes below ground. The all-NPN output stage swings to within a few millivolts of ground while sinking current. No power consuming pull down resistors are needed.

For surface mount applications where three times higher supply current is acceptable, the micropower LT1077 single, LT2078 dual and LT2079 quad are recommended. The LT1077/LT2078/LT2079 have significantly higher bandwidth, slew rate, lower voltage noise and better output drive capability. For applications requiring DIP packages refer to the LT1178/LT1179.

## TYPICAL APPLICATION

### Self-Buffered, Dual Output, Micropower Reference

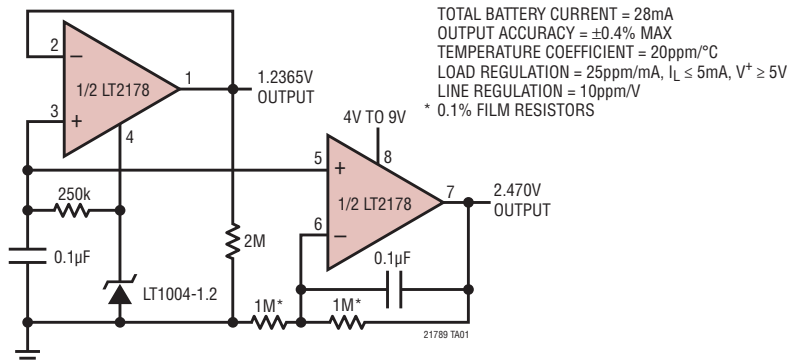

### Supply Current vs Temperature

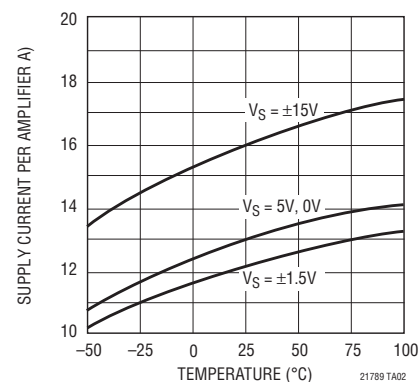

# LT2178/LT2179

## ABSOLUTE MAXIMUM RATINGS

Supply Voltage .....  $\pm 22V$   
 Differential Input Voltage .....  $\pm 30V$   
 Input Voltage ..... Equal to Positive Supply Voltage  
 ..... 5V Below Negative Supply Voltage  
 Output Short-Circuit Duration ..... Indefinite

Specified Temperature Range  
 Commercial .....  $0^{\circ}C$  to  $70^{\circ}C$   
 Industrial .....  $-40^{\circ}C$  to  $85^{\circ}C$   
 Storage Temperature Range .....  $-65^{\circ}C$  to  $150^{\circ}C$   
 Lead Temperature (Soldering, 10 sec) .....  $300^{\circ}C$

## PIN CONFIGURATION

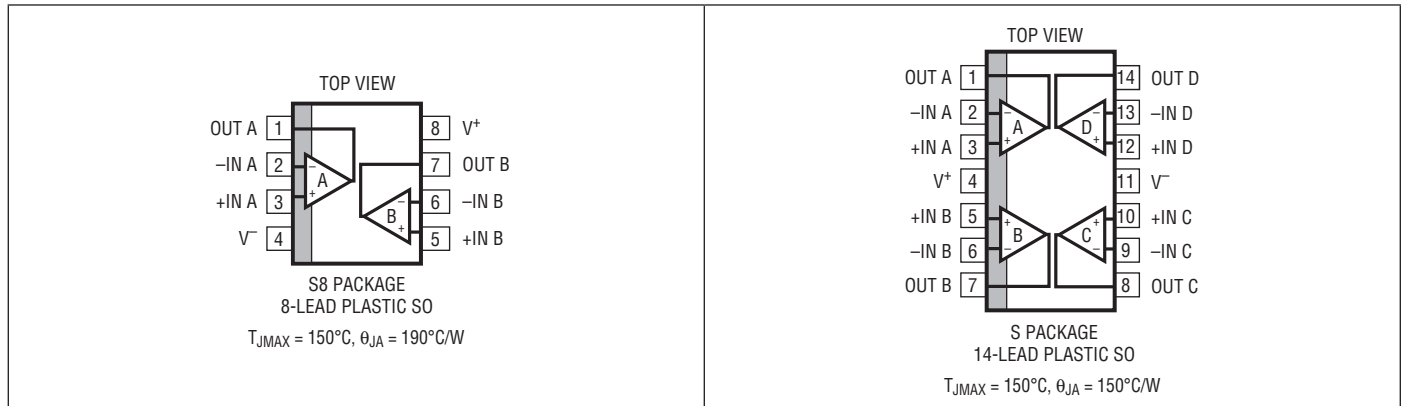

## ORDER INFORMATION

LEAD FREE FINISH	TAPE AND REEL	PART MARKING	PACKAGE DESCRIPTION	TEMPERATURE RANGE
LT2178ACS8#PBF	LT2178ACS8#TRPBF	2178A	8-Lead Plastic SO	$0^{\circ}C$ to $70^{\circ}C$
LT2178AIS8#PBF	LT2178AIS8#TRPBF	2178AI	8-Lead Plastic SO	$-40^{\circ}C$ to $85^{\circ}C$
LT2178CS8#PBF	LT2178CS8#TRPBF	2178	8-Lead Plastic SO	$0^{\circ}C$ to $70^{\circ}C$
LT2178IS8#PBF	LT2178IS8#TRPBF	2178I	8-Lead Plastic SO	$-40^{\circ}C$ to $85^{\circ}C$
LT2179ACS#PBF	LT2179ACS#TRPBF	2179A	14-Lead Plastic SO	$0^{\circ}C$ to $70^{\circ}C$
LT2179CS#PBF	LT2179CS#TRPBF	2179	14-Lead Plastic SO	$0^{\circ}C$ to $70^{\circ}C$
LT2179IS#PBF	LT2179IS#TRPBF	2179I	14-Lead Plastic SO	$-40^{\circ}C$ to $85^{\circ}C$
LEAD BASED FINISH	TAPE AND REEL	PART MARKING	PACKAGE DESCRIPTION	TEMPERATURE RANGE
LT2178ACS8	LT2178ACS8#TR	2178A	8-Lead Plastic SO	$0^{\circ}C$ to $70^{\circ}C$
LT2178AIS8	LT2178AIS8#TR	2178AI	8-Lead Plastic SO	$-40^{\circ}C$ to $85^{\circ}C$
LT2178CS8	LT2178CS8#TR	2178	8-Lead Plastic SO	$0^{\circ}C$ to $70^{\circ}C$
LT2178IS8	LT2178IS8#TR	2178I	8-Lead Plastic SO	$-40^{\circ}C$ to $85^{\circ}C$
LT2179ACS	LT2179ACS#TR	2179A	14-Lead Plastic SO	$0^{\circ}C$ to $70^{\circ}C$
LT2179CS	LT2179CS#TR	2179	14-Lead Plastic SO	$0^{\circ}C$ to $70^{\circ}C$
LT2179IS	LT2179IS#TR	2179I	14-Lead Plastic SO	$-40^{\circ}C$ to $85^{\circ}C$

Consult LTC Marketing for parts specified with wider operating temperature ranges.

For more information on lead free part marking, go to: <http://www.linear.com/leadfree/>

For more information on tape and reel specifications, go to: <http://www.linear.com/tapeandreeel/>

**ELECTRICAL CHARACTERISTICS**  $V_S = 5V, 0V, V_{CM} = 0.1V, V_O = 1.4V, T_A = 25^\circ C$ , unless otherwise noted.

SYMBOL	PARAMETER	CONDITIONS	LT2178AC/LT2178AI LT2179AC			LT2178C/LT2178I LT2179C/LT2179I			UNITS
			MIN	TYP	MAX	MIN	TYP	MAX	
$V_{OS}$	Input Offset Voltage	LT2178 LT2179		30 35	70 100		40 40	120 150	$\mu V$ $\mu V$
$\frac{\Delta V_{OS}}{\Delta Time}$	Long Term Input Offset Voltage Stability			0.5			0.6		$\mu V/Mo$
$I_{OS}$	Input Offset Current			0.05	0.25		0.05	0.35	nA
$I_B$	Input Bias Current			3	5		3	6	nA
$e_n$	Input Noise Voltage	0.1Hz to 10Hz (Note 2)		0.9	2.0		0.9		$\mu V_{P-P}$
	Input Noise Voltage Density	$f_0 = 10Hz$ (Note 2) $f_0 = 1000Hz$ (Note 2)		50 49	75 65		50 49		$nV/\sqrt{Hz}$ $nV/\sqrt{Hz}$
$i_n$	Input Noise Current	0.1Hz to 10Hz (Note 2)		1.5	2.5		1.5		$pA_{P-P}$
	Input Noise Current Density	$f_0 = 10Hz$ (Note 2) $f_0 = 1000Hz$		0.03 0.01	0.07		0.03 0.01		$pA/\sqrt{Hz}$ $pA/\sqrt{Hz}$
	Input Resistance Differential Mode Common Mode	(Note 3)		0.8 2 12			0.6 2 12		$G\Omega$ $G\Omega$
	Input Voltage Range			3.5 0	3.9 -0.3		3.5 0	3.9 -0.3	V V
CMRR	Common Mode Rejection Ratio	$V_{CM} = 0V$ to 3.5V		93	103		90	102	dB
PSRR	Power Supply Rejection Ratio	$V_S = 2.2V$ to 12V		94	104		92	104	dB
$A_{VOL}$	Large-Signal Voltage Gain	$V_O = 0.03V$ to 4V, No Load (Note 3) $V_O = 0.03V$ to 3.5V, $R_L = 50k$		140 80	700 200		110 70	700 200	V/mV V/mV
	Maximum Output Voltage Swing	Output Low, No Load		6.5	9		6.5	9	mV
		Output Low, 2k to GND		0.2	0.6		0.2	0.6	mV
		Output Low, $I_{SINK} = 100\mu A$		120	160		120	160	mV
		Output High, No Load		4.2	4.4		4.2	4.4	V
	Output High, 2k to GND		3.5	3.8		3.5	3.8	V	
SR	Slew Rate	$A_V = 1, C_L = 10pF$ (Note 3)		0.013	0.025		0.013	0.025	V/ $\mu s$
GBW	Gain Bandwidth Product	$f_0 \leq 5kHz$		60			60		kHz
$I_S$	Supply Current per Amplifier	$V_S = \pm 1.5V, V_O = 0V$		13 12	18 17		14 13	21 20	$\mu A$ $\mu A$
	Channel Separation	$\Delta V_{IN} = 3V, R_L = 10k$		110			110		dB
	Minimum Supply Voltage	(Note 4)		2	2.2		2	2.2	V

The ● denotes the specifications which apply over the full operating temperature range.  $V_S = 5V, 0V, V_{CM} = 0.1V, V_O = 1.4V, -40^\circ C \leq T_A \leq 85^\circ C$  for I-grades, unless otherwise noted. (Note 6)

SYMBOL	PARAMETER	CONDITIONS		LT2178AI			LT2178I/LT2179I			UNITS
				MIN	TYP	MAX	MIN	TYP	MAX	
$V_{OS}$	Input Offset Voltage	LT2178 LT2179	● ●		70 80	270 300		95 100	370 400	$\mu V$ $\mu V$
$\frac{\Delta V_{OS}}{\Delta T}$	Input Offset Voltage Drift	LT2178 (Note 5) LT2179	●		0.4 0.5	1.8 3		0.5 0.6	2.3 3.5	$\mu V/^\circ C$ $\mu V/^\circ C$
$I_{OS}$	Input Offset Current		●		0.07	0.70		0.1	1	nA
$I_B$	Input Bias Current		●		3	7		4	8	nA
CMRR	Common Mode Rejection Ratio	$V_{CM} = 0.05V$ to 3.2V	●		86	100		84	98	dB
PSRR	Power Supply Rejection Ratio	$V_S = 3V$ to 12V	●		88	100		86	100	dB

# LT2178/LT2179

**ELECTRICAL CHARACTERISTICS** The ● denotes the specifications which apply over the full operating temperature range.  $V_S = 5V, 0V, V_{CM} = 0.1V, V_O = 1.4V, -40^\circ C \leq T_A \leq 85^\circ C$  for I-grades, unless otherwise noted. (Note 6)

SYMBOL	PARAMETER	CONDITIONS	LT2178AI			LT2178I/LT2179I			UNITS
			MIN	TYP	MAX	MIN	TYP	MAX	
A <sub>VOL</sub>	Large-Signal Voltage Gain	V <sub>O</sub> = 0.05V to 4V, No Load (Note 3)	● 75	350		50	350		V/mV
		V <sub>O</sub> = 0.05V to 3.5V, R <sub>L</sub> = 50k	● 40	130		30	130		V/mV
	Maximum Output Voltage Swing	Output Low, No Load	●	9	13		9	13	mV
		Output Low, I <sub>SINK</sub> = 100μA	●	160	220		160	220	mV
		Output High, No Load	● 3.9	4.2		3.9	4.2		V
		Output High, 2k to GND	● 3	3.7		3	3.7		V
			●	15	24		15	27	μA

The ● denotes the specifications which apply over the full operating temperature range.  $V_S = 5V, 0V, V_{CM} = 0.1V, V_O = 1.4V, 0^\circ C \leq T_A \leq 70^\circ C$ , unless otherwise noted. (Note 7)

SYMBOL	PARAMETER	CONDITIONS	LT2178AC/LT2179AC			LT2178C/LT2179C			UNITS
			MIN	TYP	MAX	MIN	TYP	MAX	
V <sub>OS</sub>	Input Offset Voltage	LT2178	●	50	170		65	250	V/mV
		LT2179	●	60	200		70	290	V/mV
$\frac{\Delta V_{OS}}{\Delta T}$	Input Offset Voltage Drift	LT2178 (Note 5)	●	0.4	1.8		0.5	2.5	mV
		LT2179	●	0.5	3		0.6	3.5	mV
I <sub>OS</sub>	Input Offset Current		●	0.06	0.35		0.06	0.5	nA
I <sub>B</sub>	Input Bias Current		●	3	6		3	7	nA
CMRR	Common Mode Rejection Ratio	V <sub>CM</sub> = 0V to 3.4V	●	90	101		86	100	dB
PSRR	Power Supply Rejection Ratio	V <sub>S</sub> = 2.5V to 12V	●	90	102		88	102	dB
A <sub>VOL</sub>	Large-Signal Voltage Gain	V <sub>O</sub> = 0.05V to 4V, No Load (Note 3)	● 150	500		80	500		V/mV
		V <sub>O</sub> = 0.05V to 3.5V, R <sub>L</sub> = 50k	● 55	160		45	160		V/mV
	Maximum Output Voltage Swing	Output Low, No Load	●	8	11		8	11	mV
		Output Low, I <sub>SINK</sub> = 100μA	●	140	190		140	190	mV
		Output High, No Load	● 4.1	4.3		4.1	4.3		V
		Output High, 2k to GND	● 3.3	3.8		3.3	3.8		V

$V_S = \pm 15V, T_A = 25^\circ C$ , unless otherwise noted.

SYMBOL	PARAMETER	CONDITIONS	LT2178AC/LT2178AI LT2179AC			LT2178C/LT2178I LT2179C/LT2179I			UNITS
			MIN	TYP	MAX	MIN	TYP	MAX	
V <sub>OS</sub>	Input Offset Voltage	LT2178		70	300		90	400	μV
		LT2179		80	350		100	450	μV
I <sub>OS</sub>	Input Offset Current			0.05	0.25		0.05	0.35	nA
I <sub>B</sub>	Input Bias Current			3	5		3	6	nA
		Input Voltage Range		13.5	13.9		13.5	13.9	V
				-15	-15.3		-15	-15.3	V
CMRR	Common Mode Rejection Ratio	V <sub>CM</sub> = 13.5V to -15V		96	106		93	106	dB
PSRR	Power Supply Rejection Ratio	V <sub>S</sub> = 5V, 0V to ±18V		96	112		94	112	dB
A <sub>VOL</sub>	Large-Signal Voltage Gain	V <sub>O</sub> = ±10V, R <sub>L</sub> = 50k		300	1200		250	1000	V/mV
		V <sub>O</sub> = ±10V, No Load		600	2500		400	2500	V/mV
V <sub>OUT</sub>	Maximum Output Voltage Swing	R <sub>L</sub> = 50k		±13	±14.2		±13	±14.2	V
		R <sub>L</sub> = 2k		±11	±12.7		±11	±12.7	V
SR	Slew Rate	A <sub>V</sub> = 1		0.02	0.04		0.02	0.04	V/μs

**ELECTRICAL CHARACTERISTICS** The ● denotes the specifications which apply over the full operating temperature range.  $V_S = 5V, 0V, V_{CM} = 0.1V, V_O = 1.4V, -40^{\circ}C \leq T_A \leq 85^{\circ}C$  for I-grades, unless otherwise noted. (Note 6)

SYMBOL	PARAMETER	CONDITIONS	LT2178AC/LT2178AI LT2179AC			LT2178C/LT2178I LT2179C/LT2179I			UNITS
			MIN	TYP	MAX	MIN	TYP	MAX	
GBW	Gain Bandwidth Product	$f_0 \leq 5kHz$	85			85			kHz
$I_S$	Supply Current per Amplifier		16	21		17	25	$\mu A$	

The ● denotes the specifications which apply over the full operating temperature range.  $V_S = \pm 15V, -40^{\circ}C \leq T_A \leq 85^{\circ}C$  for I-grades, unless otherwise noted.

SYMBOL	PARAMETER	CONDITIONS	LT2178AI			LT2178I/LT2179I			UNITS
			MIN	TYP	MAX	MIN	TYP	MAX	
$V_{OS}$	Input Offset Voltage	LT2178	●	100	650		130	740	$\mu V$
		LT2179	●	100	650		130	740	$\mu V$
$\frac{\Delta V_{OS}}{\Delta T}$	Input Offset Voltage Drift	LT2178 (Note 5)	●	0.6	1.8		0.7	2.5	$\mu V/^{\circ}C$
		LT2179		0.7	3		0.9	4	$\mu V/^{\circ}C$
$I_{OS}$	Input Offset Current		●	0.07	0.7		0.1	1	nA
$I_B$	Input Bias Current		●	3	7		4	8	nA
$A_{VOL}$	Large-Signal Voltage Gain	$V_O = \pm 10V, R_L = 50k$	●	150	500		100	500	V/mV
CMRR	Common Mode Rejection Ratio	$V_{CM} = 13V, -14.9V$	●	90	105		88	103	dB
PSRR	Power Supply Rejection Ratio	$V_S = 0V, 5V$ to $\pm 18V$	●	92	110		88	109	dB
	Maximum Output Voltage Swing	$R_L = 5k$	●	$\pm 11$	$\pm 13.5$		$\pm 11$	$\pm 13.5$	V
$I_S$	Supply Current per Amplifier		●	18	28		19	30	$\mu A$

The ● denotes the specifications which apply over the full operating temperature range.  $V_S = \pm 15V, 0^{\circ}C \leq T_A \leq 70^{\circ}C$ , unless otherwise noted.

SYMBOL	PARAMETER	CONDITIONS	LT2178AC/LT2179AC			LT2178C/LT2179C			UNITS
			MIN	TYP	MAX	MIN	TYP	MAX	
$V_{OS}$	Input Offset Voltage	LT2178	●	100	480		130	660	$\mu V$
		LT2179	●	120	550		150	750	$\mu V$
$\frac{\Delta V_{OS}}{\Delta T}$	Input Offset Voltage Drift	LT2178 (Note 5)	●	0.6	1.5		0.7	2.5	$\mu V/^{\circ}C$
		LT2179		0.7	3		0.9	4	$\mu V/^{\circ}C$
$I_{OS}$	Input Offset Current		●	0.06	0.35		0.06	0.35	nA
$I_B$	Input Bias Current		●	3	6		3	7	nA
$A_{VOL}$	Large-Signal Voltage Gain	$V_O = \pm 10V, R_L = 50k$	●	200	800		150	750	V/mV
CMRR	Common Mode Rejection Ratio	$V_{CM} = 13V, -15V$	●	94	104		91	104	dB
PSRR	Power Supply Rejection Ratio	$R_L = 5k$	●	93	110		91	110	dB
	Maximum Output Voltage Swing	$R_L = 5k$	●	$\pm 11$	$\pm 13.6$		$\pm 11$	$\pm 13.6$	V
$I_S$	Supply Current per Amplifier		●	17	24		18	28	$\mu A$

**Note 1:** Stresses beyond those listed under Absolute Maximum Ratings may cause permanent damage to the device. Exposure to any Absolute Maximum Rating condition for extended periods may affect device reliability and lifetime.

**Note 2:** Typical parameters are defined as the 60% yield of parameter distributions of individual amplifiers, i.e., out of 100 LT2179s (or 100 LT2178s) typically 240 op amps (or 120) will be better than the indicated specification.

**Note 3:** This parameter is tested on a sample basis only. All noise parameters are tested with  $V_S = \pm 2.5V, V_O = 0V$ .

**Note 4:** This parameter is guaranteed by design and is not tested.

**Note 5:** Power supply rejection ratio is measured at the minimum supply voltage. The op amps actually work at 1.7V supply but with a typical offset skew of  $-300\mu V$ .

**Note 6:** This parameter is not 100% tested.

**Note 7:** During testing at  $-40^{\circ}C$ , the 5V power supply turn-on time is less than 0.5s.

**Note 8:** The LT2178C/LT2179C are designed, characterized and expected to meet the industrial temperature limits, but are not tested at  $-40^{\circ}C$  and  $85^{\circ}C$ . I-grade parts are guaranteed.

## TYPICAL PERFORMANCE CHARACTERISTICS

**Distribution of Input Offset Voltage**

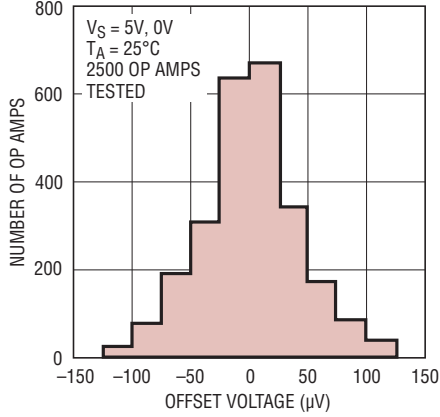

21789 G01

**Minimum Supply Voltage**

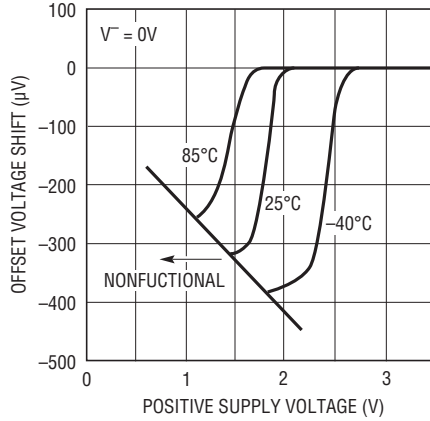

21789 G02

**Input Bias and Offset Currents vs Temperature**

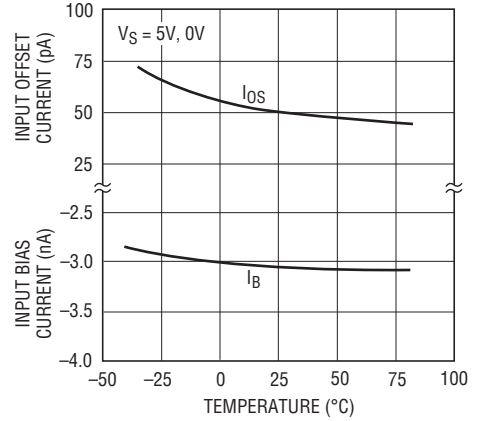

21789 G03

**Output Saturation vs Temperature vs Sink Current**

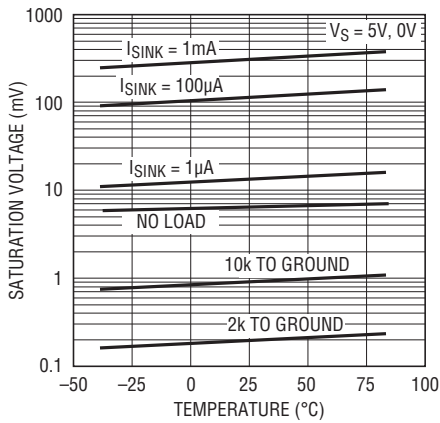

21789 G04

**Short-Circuit Current**

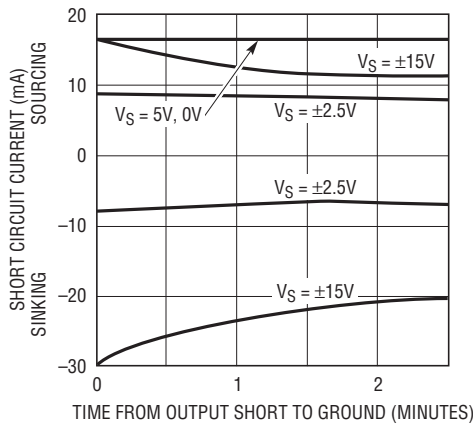

21789 G05

**0.1Hz to 10Hz Noise**

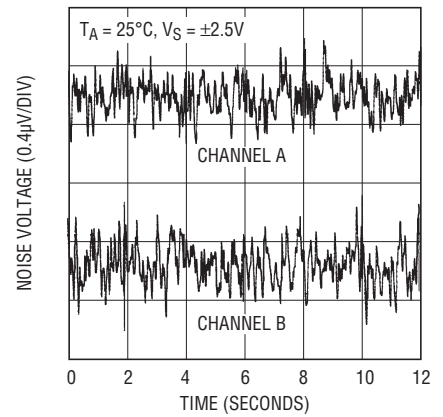

21789 G06

**0.01Hz to 10Hz Noise**

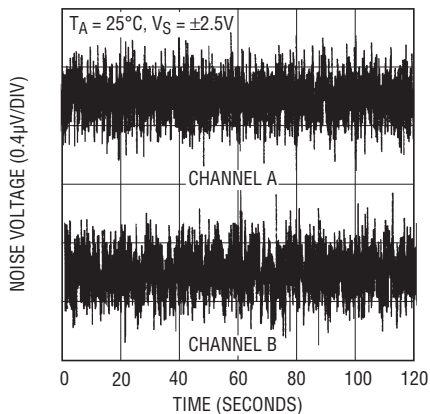

21789 G07

**Noise Spectrum**

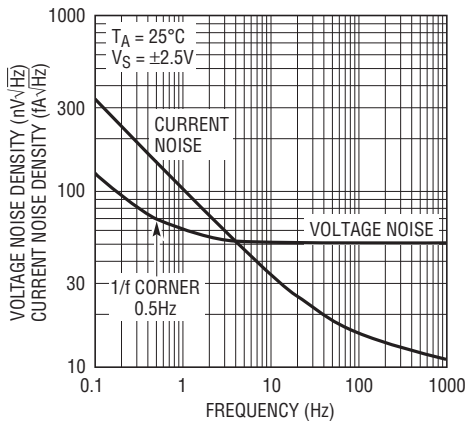

21789 G08

**Voltage Gain vs Frequency**

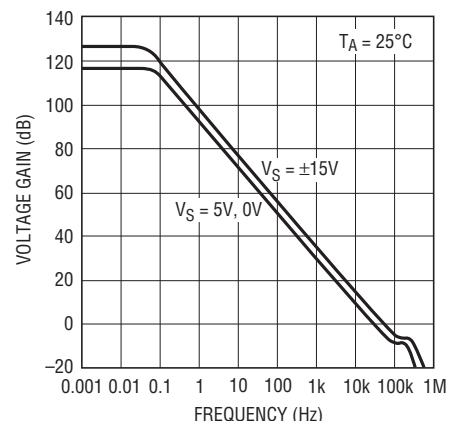

21789 G09

# TYPICAL PERFORMANCE CHARACTERISTICS

**Gain, Phase vs Frequency**

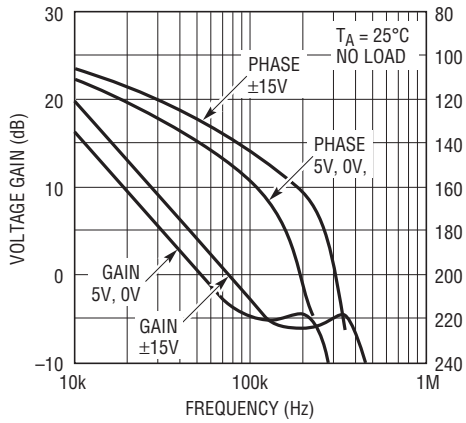

21789 G10

**Voltage Gain vs Load Resistance**

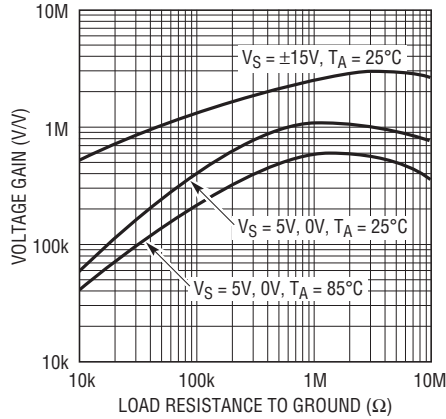

21789 G11

**Capacitive Load Handling**

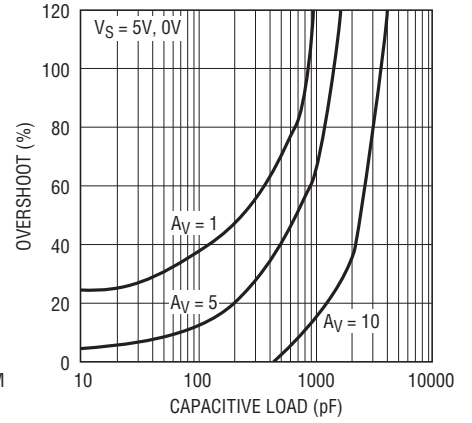

20789 G12

**Large-Signal Transient Response  
VS = ±15V**

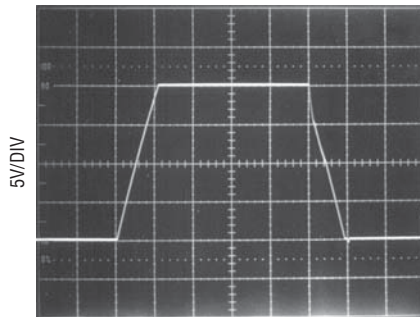

AV = 1  
CL = 12pF

21789 G13

**Large-Signal Transient Response  
VS = 5V, 0V**

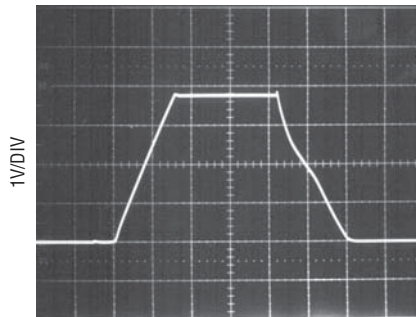

AV = 1  
CL = 12pF  
INPUT PULSE = 0V TO 3.8V

21789 G14

**Small-Signal Transient Response  
VS = ±2.5V**

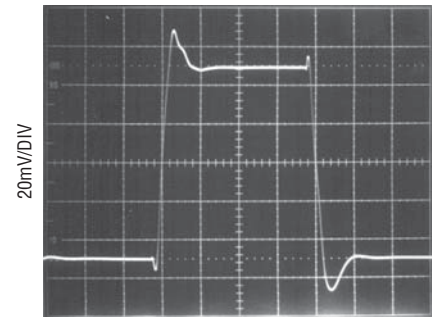

AV = 1  
CL = 12pF

21789 G15

**Small-Signal Transient Response  
VS = ±15V**

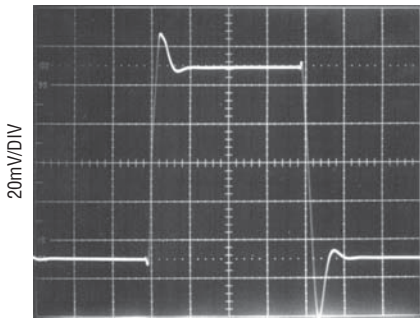

AV = 1  
CL = 12pF

21789 G16

**Small-Signal Transient Response  
VS = 5V, 0V**

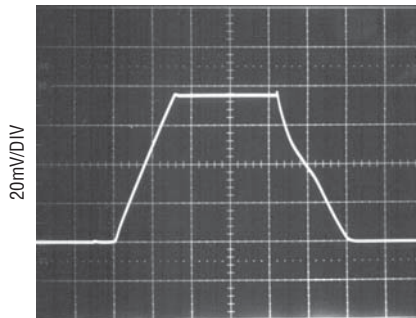

AV = 1  
CL = 12pF  
INPUT PULSE = 50mV TO 150mV

21789 G17

**Common Mode Rejection Ratio vs Frequency**

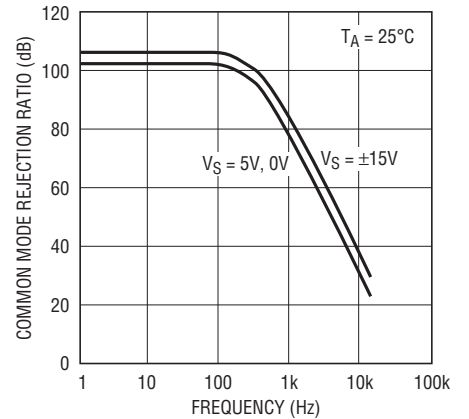

21789 G18

TYPICAL PERFORMANCE CHARACTERISTICS

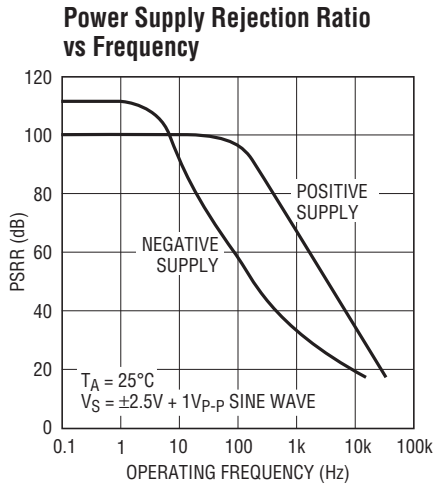

21789 G19

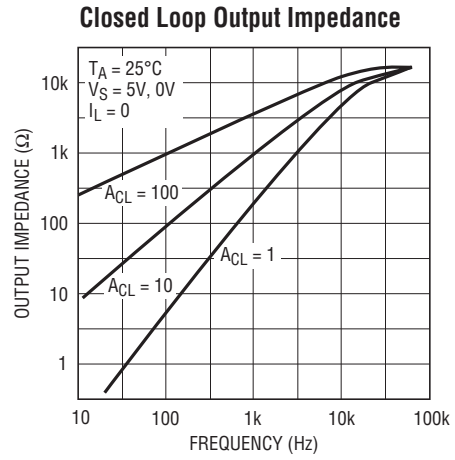

21789 G20

SIMPLIFIED SCHEMATIC

1/2 LT2178  
1/4 LT2179

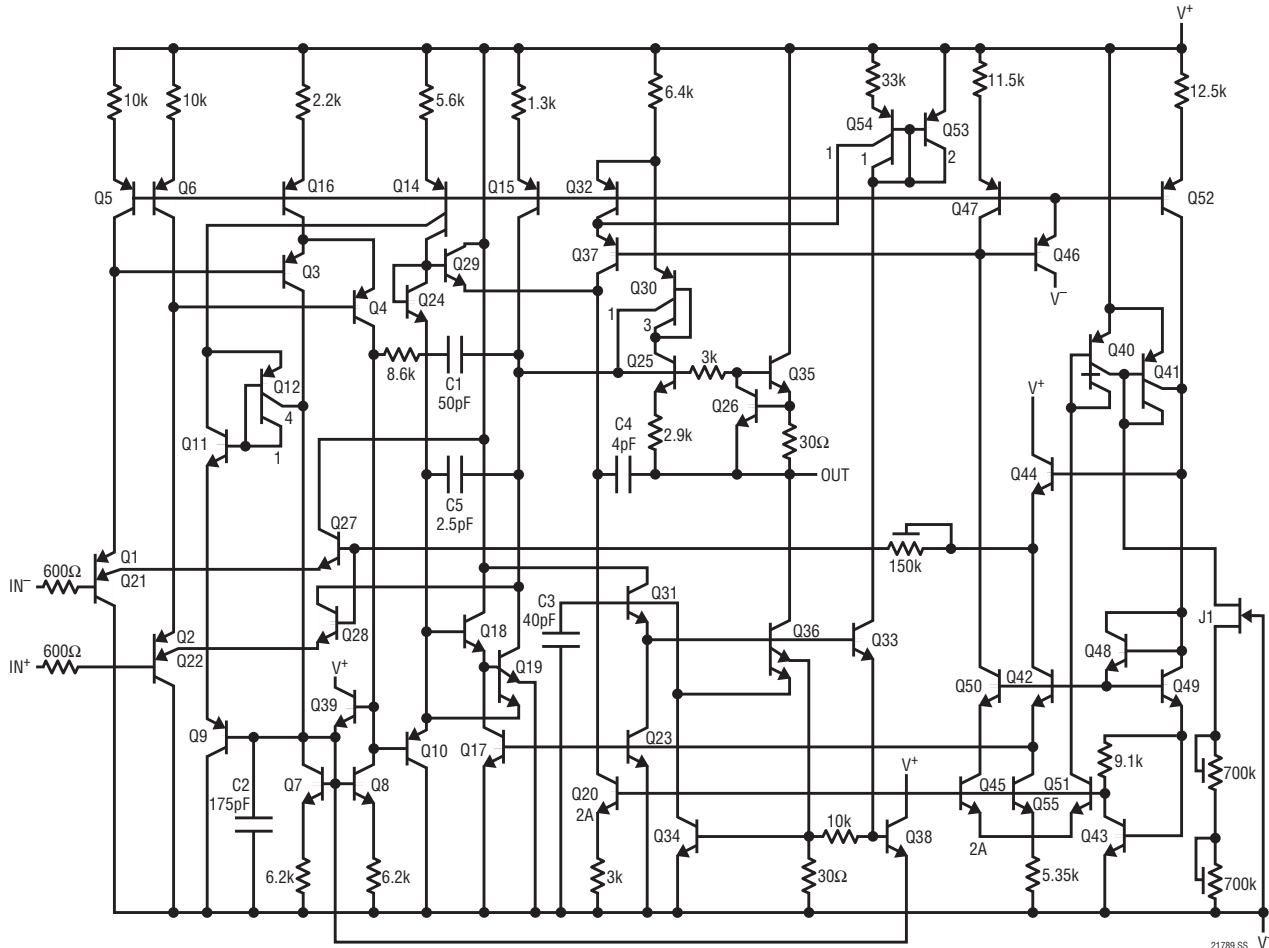

21789 SS V

21789fc



# APPLICATIONS INFORMATION

Please see the LT2078/LT2079 data sheet for applications information. All comments relating to specifications, single

supply operation and phase reversal protection are directly applicable to the LT2178/LT2179.

Micropower 100Hz to 1MHz V-to-F Converter

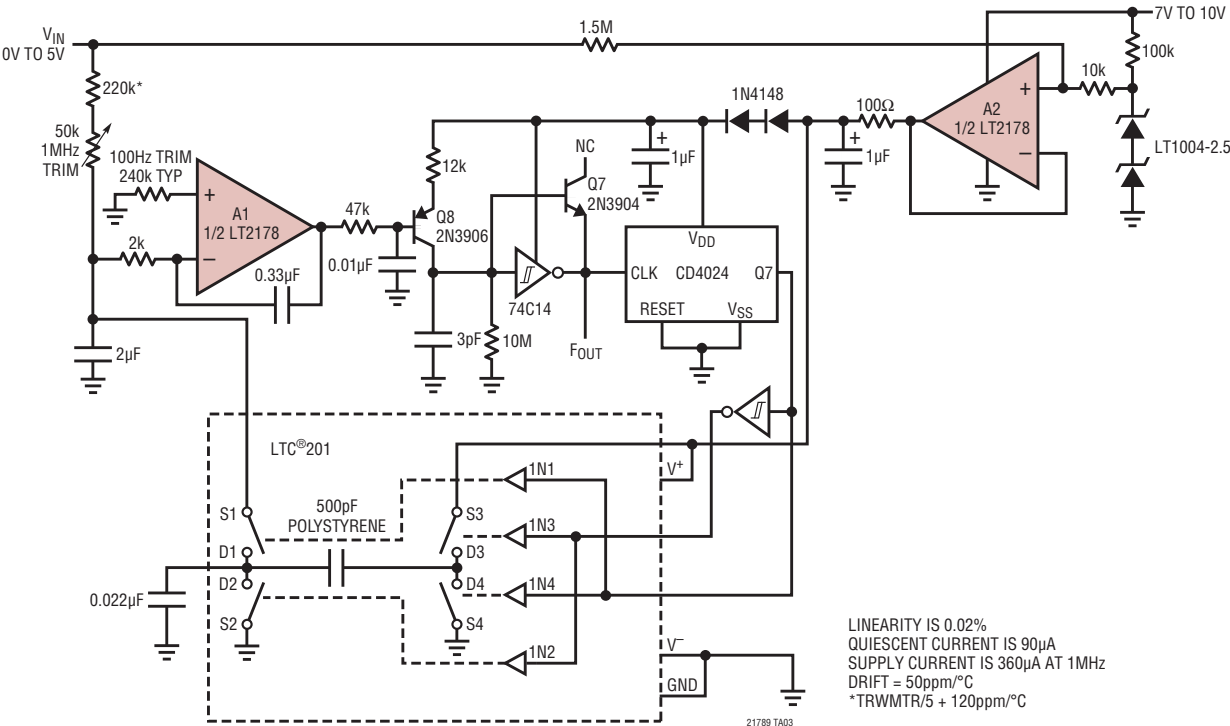

**PACKAGE DESCRIPTION**

**S8 Package**  
**8-Lead Plastic Small Outline (Narrow 0.150)**  
 (Reference LTC DWG # 05-08-1610)

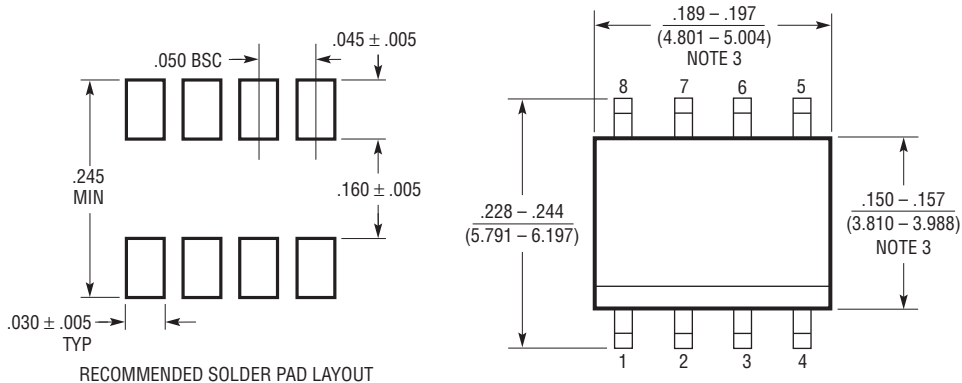

RECOMMENDED SOLDER PAD LAYOUT

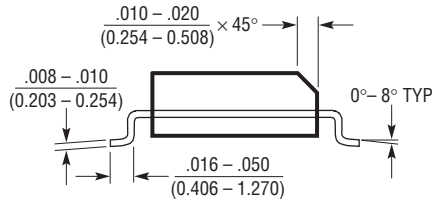

NOTE:  
 1. DIMENSIONS IN  $\frac{\text{INCHES}}{\text{MILLIMETERS}}$   
 2. DRAWING NOT TO SCALE

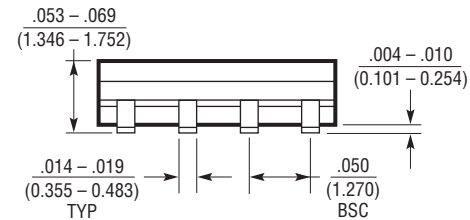

3. THESE DIMENSIONS DO NOT INCLUDE MOLD FLASH OR PROTRUSIONS.  
 MOLD FLASH OR PROTRUSIONS SHALL NOT EXCEED .006" (0.15mm)

S08 0303

**S Package**  
**14-Lead Plastic Small Outline (Narrow 0.150)**  
 (Reference LTC DWG # 05-08-1610)

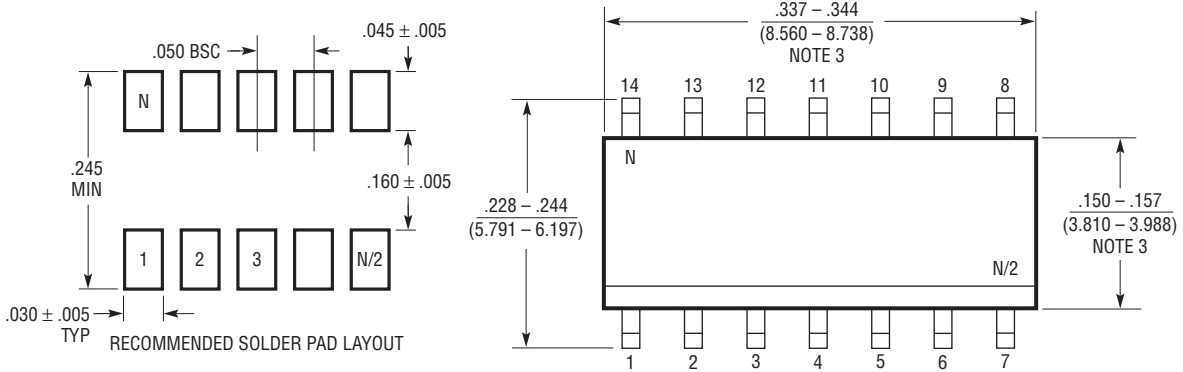

RECOMMENDED SOLDER PAD LAYOUT

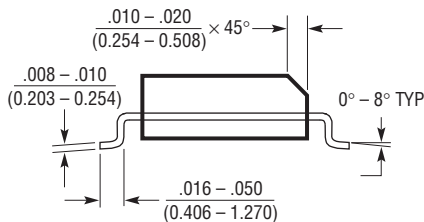

NOTE:  
 1. DIMENSIONS IN  $\frac{\text{INCHES}}{\text{MILLIMETERS}}$   
 2. DRAWING NOT TO SCALE

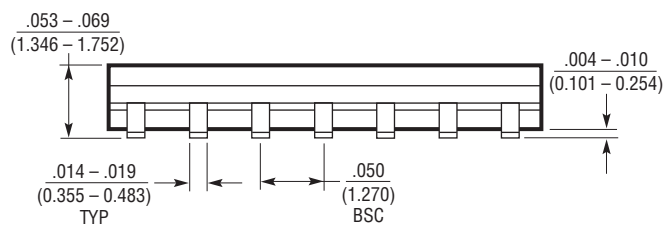

3. THESE DIMENSIONS DO NOT INCLUDE MOLD FLASH OR PROTRUSIONS.  
 MOLD FLASH OR PROTRUSIONS SHALL NOT EXCEED .006" (0.15mm)

S14 0502

**REVISION HISTORY** (Revision history begins at Rev C)

REV	DATE	DESCRIPTION	PAGE NUMBER
C	3/10	Correct the part numbers on S Package in the Order Information Section.	2
		Update to graph G04	6

## TYPICAL APPLICATION

### Single Supply, 1kHz, 4th Order Butterworth Lowpass Filter

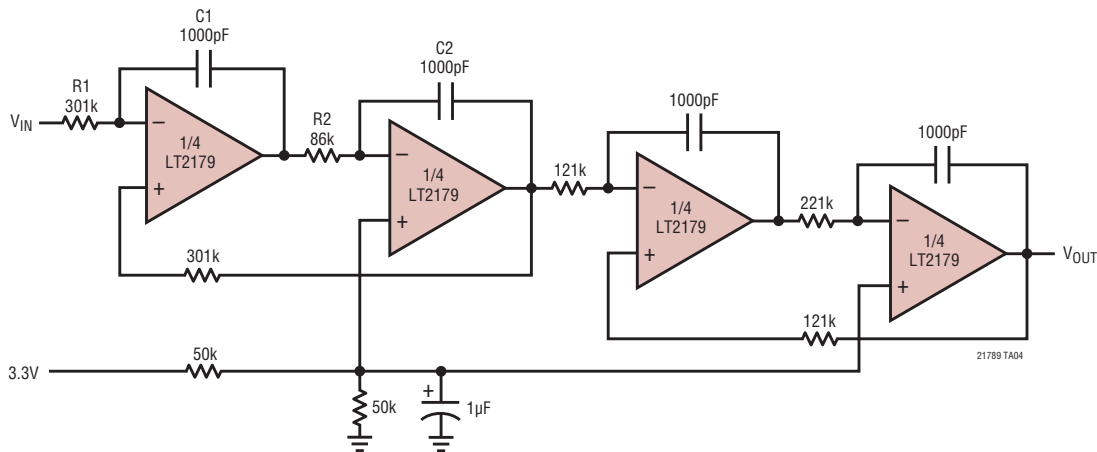

12-BIT ACCURATE SIGNAL RANGE FROM 6mV TO 1.8V ON 3.3V SINGLE SUPPLY.  
MAXIMUM OUTPUT OFFSET ERROR IS 448µV.

FOR EACH 2ND ORDER SECTION:

$$W_0^2 = \frac{1}{C_1 C_2 R_1 R_2}$$

$$R_1 = \frac{1}{W_0 Q C_1}$$

$$R_2 = \frac{Q}{W_0 C_2}$$

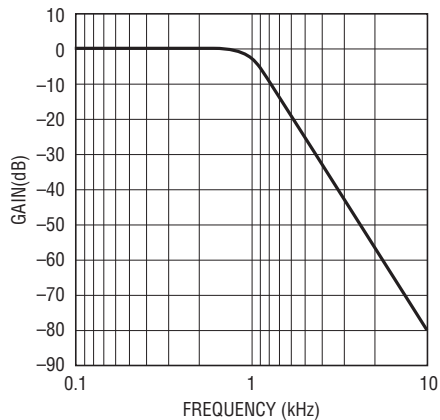

21789 TA05

## RELATED PARTS

PART NUMBER	DESCRIPTION	COMMENTS
LT1078/LT1079	Dual/Quad 55µA Max, Single Supply Precision Op Amps	70µV $V_{OS}$ Max and 2.5µV/°C Drift Max, 200kHz BBW, 0.07V/µs Slew Rate, Input/Output Common Mode Includes Ground
LT1211/LT1212	14MHz, 7V/µs Single Supply Dual and Quad Precision Op Amps	275µV $V_{OS}$ Max, 6µV/°C Drift Max Input Voltage Range Includes Ground
LT1490/LT1491	Dual/ Quad Micropower Rail-to-Rail Input and Output Op Amps	Single Supply Input Range: -0.4V to 44V, Micropower 50µA Amplifier, Rail-to-Rail Input and Output, 200kHz GBW
LT2078/LT2079	Dual/Quad 55µA Max, Single Supply Precision Op Amps	70µV $V_{OS}$ Max and 2.5µV/°C Drift Max, 200kHz BBW, 0.07V/µs Slew Rate, Input/Output Common Mode Includes Ground Surface Mount Standard Pinout



Компания «ЭлектроПласт» предлагает заключение долгосрочных отношений при поставках импортных электронных компонентов на взаимовыгодных условиях!

Наши преимущества:

- Оперативные поставки широкого спектра электронных компонентов отечественного и импортного производства напрямую от производителей и с крупнейших мировых складов;
- Поставка более 17-ти миллионов наименований электронных компонентов;
- Поставка сложных, дефицитных, либо снятых с производства позиций;
- Оперативные сроки поставки под заказ (от 5 рабочих дней);
- Экспресс доставка в любую точку России;
- Техническая поддержка проекта, помощь в подборе аналогов, поставка прототипов;
- Система менеджмента качества сертифицирована по Международному стандарту ISO 9001;
- Лицензия ФСБ на осуществление работ с использованием сведений, составляющих государственную тайну;
- Поставка специализированных компонентов (Xilinx, Altera, Analog Devices, Intersil, Interpoint, Microsemi, Aeroflex, Peregrine, Syfer, Eurofarad, Texas Instrument, Miteq, Cobham, E2V, MA-COM, Hittite, Mini-Circuits, General Dynamics и др.);

Помимо этого, одним из направлений компании «ЭлектроПласт» является направление «Источники питания». Мы предлагаем Вам помощь Конструкторского отдела:

- Подбор оптимального решения, техническое обоснование при выборе компонента;
- Подбор аналогов;
- Консультации по применению компонента;
- Поставка образцов и прототипов;
- Техническая поддержка проекта;
- Защита от снятия компонента с производства.



#### Как с нами связаться

**Телефон:** 8 (812) 309 58 32 (многоканальный)

**Факс:** 8 (812) 320-02-42

**Электронная почта:** [org@eplast1.ru](mailto:org@eplast1.ru)

**Адрес:** 198099, г. Санкт-Петербург, ул. Калинина, дом 2, корпус 4, литера А.