

SERIES 47A
Miniature Rocker and Paddle
Switches

FEATURES

- Save Space and Weight
- SPDT, DPDT, 3PDT and 4PDT Circuitry
- Choice of Actuators and Terminations
- UL Recognized



MODELS In inches (and millimeters)

MODEL NO.	SWITCH POSITION		
SP1	ON	NONE	ON
SP2	ON	NONE	(ON)
SP3	ON	OFF	ON
SP4	(ON)	OFF	(ON)
SP5	ON	OFF	(ON)
TERM. COMM.	2-3	OPEN	2-1

()=MOMENTARY
 02COMM.

SCHEMATIC



SPDT

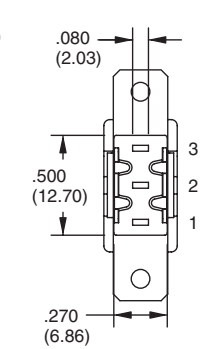

MODEL NO.	SWITCH POSITION		
DP1	ON	NONE	ON
DP2	ON	NONE	(ON)
DP3	ON	OFF	ON
DP4	(ON)	OFF	(ON)
DP5	ON	OFF	(ON)
TERM. COMM.	2-3,5-6	OPEN	2-1,5-4

()=MOMENTARY
 02COMM. 05COMM.

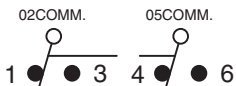

SCHEMATIC

DPDT

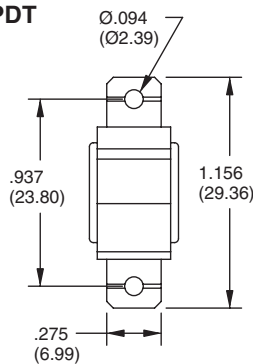

MODEL NO.	SWITCH POSITION		
3P1	ON	NONE	ON
3P2	ON	NONE	(ON)
3P3	ON	OFF	ON
3P4	(ON)	OFF	(ON)
3P5	ON	OFF	(ON)
TERM. COMM.	2-3,5-6	OPEN	2-1,5-4

()=MOMENTARY
 02COMM. 05COMM. 08COMM.

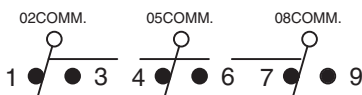

SCHEMATIC

3PDT

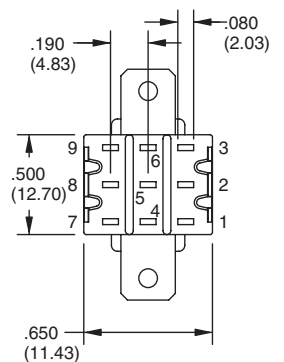
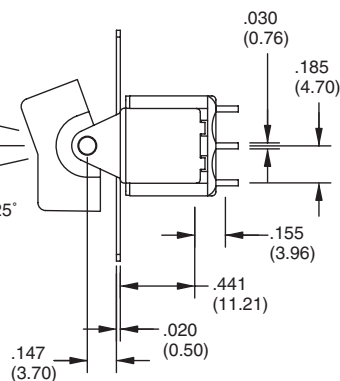
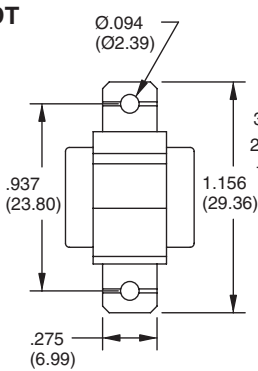

MODELS In inches (and millimeters)

4PDT

MODEL NO.	SWITCH POSITION		
4P1	ON	NONE	ON
4P2	ON	NONE	(ON)
4P3	ON	OFF	ON
4P4	(ON)	OFF	(ON)
4P5	ON	OFF	(ON)
TERM. COMM.	2-3,5-6	OPEN	2-1,5-4

()=MOMENTARY

02COMM. 05COMM. 08COMM.

1 3 4 6 7 9

SCHEMATIC

Dimensions: $\text{Ø}0.094$ (2.39), .937 (23.80), 1.156 (29.36), .275 (6.99), .030 (0.76), .185 (4.70), .080 (2.03), .190 (4.83), .500 (12.70), .155 (3.96), .441 (11.21), .020 (0.50), .147 (3.70), .850 (11.43), .375 (9.52), .138 (3.50), .020 (0.50), .084 (2.13), .332 R. (8.43 R.), .740 (18.8), .138 (3.50), .020 (0.50), .320 (8.13), .906 (23.01), .576 NOM. (14.63), .383 (9.73), .024 (0.61), .138 (3.50), .093 (2.36), .888 (22.56), 1.174 (29.82), 1.312 (33.32), .024 (0.61), .138 (3.50), .437 (11.10).

ACTUATOR OPTIONS: For Panel Mount Only In inches (and millimeters)

R1

Dimensions: 1.156 (29.36), .365 (9.27), .275 (6.99), .937 (23.80), $\text{Ø}0.094$ (2.39).

R2

Dimensions: 1.156 (29.36), .365 (9.27), .275 (6.99), .937 (23.80), $\text{Ø}0.094$ (2.39).

R3

Dimensions: 1.625 (41.27), 1.375 (34.92), .595 (15.11) ROCKER WIDTH, .505 (12.83) BRACKET WIDTH, $\text{Ø}0.125$ (2 PLCS.) (3.17).

R4

Dimensions: 1.625 (41.27), 1.375 (34.92), .595 (15.11) ROCKER WIDTH, .505 (12.83) BRACKET WIDTH, $\text{Ø}0.125$ (2 PLCS.) (3.17).

ACTUATOR OPTIONS: For Panel Rear Mount Only In inches (and millimeters)



Rocker and Paddle Switches

ACTUATOR OPTIONS: For P.C. Mount Only In inches (and millimeters)



ACTUATOR OPTIONS: For P.C. Mount Only In inches (and millimeters)



TERMINATION OPTIONS In inches (and millimeters)



**NOTE: Solder lug terminals supplied with mounting tabs standard.
PC Mount terminals supplied without mounting tabs standard.**

TERMINATION OPTIONS In inches (and millimeters)



Rocker and Paddle Switches

TERMINATION OPTIONS In inches (and millimeters)



SPECIFICATIONS

RATINGS

Contact Rating: Q option - 5A with resistive load @ 125 VAC or 28 VDC; 2A with resistive load @ 250 VAC. R option - 0.4 VA max @ 20 Vmax (AC or DC)

Electrical Life: 40,000 make-and-break cycles at full load

Contact Resistance: 10 milliohms max. initial

@ 2-4 VDC, 100 mA

Insulation Resistance: 1,000 megaohms minimum

Dielectric Strength: 1,000 V RMS @ sea level

Operating Temperature: -30°C to 85°C

UL Recognition: File number is E35289

MATERIALS

Case: Diallyl phthalate (DAP) (UL 94V-0)

Rockers: Nylon (UL 94V-0)

Bushing: Stainless steel

Switch Support: Brass, tin-plated

Terminal/Contacts: Brass with silver or gold plate

Terminal Seal: Epoxy

ORDERING INFORMATION



Series 47A Miniature Rocker and Paddle Switches

Model: SPDT: SP1, SP2, SP3, SP4, SP5

DPDT: DP1, DP2, DP3, DP4, DP5

3PDT: 3P1, 3P2, 3P3, 3P4, 3P5

4PDT: 4P1, 4P2, 4P3, 4P4, 4P5

(See Model options.)

Actuator: R1, R2, R3, R4, R5, R6, R7

J1, J2, J3, J4, J5, J6, J7, J8 (See actuator options.)

Termination Options: M1, M2, M3, M6, M7, S6, V2, V3, W1, W2, W3, W4

(See Termination options.)

RoHS Compliant

Contact: R = Brass alloy, gold plate over nickel plate

Q = Brass alloy, silver plated

Available from your local Grayhill Component Distributor. For prices and discounts, contact a local Sales Office, an authorized local Distributor or Grayhill.



Компания «ЭлектроПласт» предлагает заключение долгосрочных отношений при поставках импортных электронных компонентов на взаимовыгодных условиях!

Наши преимущества:

- Оперативные поставки широкого спектра электронных компонентов отечественного и импортного производства напрямую от производителей и с крупнейших мировых складов;
- Поставка более 17-ти миллионов наименований электронных компонентов;
- Поставка сложных, дефицитных, либо снятых с производства позиций;
- Оперативные сроки поставки под заказ (от 5 рабочих дней);
- Экспресс доставка в любую точку России;
- Техническая поддержка проекта, помощь в подборе аналогов, поставка прототипов;
- Система менеджмента качества сертифицирована по Международному стандарту ISO 9001;
- Лицензия ФСБ на осуществление работ с использованием сведений, составляющих государственную тайну;
- Поставка специализированных компонентов (Xilinx, Altera, Analog Devices, Intersil, Interpoint, Microsemi, Aeroflex, Peregrine, Syfer, Eurofarad, Texas Instrument, Miteq, Cobham, E2V, MA-COM, Hittite, Mini-Circuits, General Dynamics и др.);

Помимо этого, одним из направлений компании «ЭлектроПласт» является направление «Источники питания». Мы предлагаем Вам помощь Конструкторского отдела:

- Подбор оптимального решения, техническое обоснование при выборе компонента;
- Подбор аналогов;
- Консультации по применению компонента;
- Поставка образцов и прототипов;
- Техническая поддержка проекта;
- Защита от снятия компонента с производства.



Как с нами связаться

Телефон: 8 (812) 309 58 32 (многоканальный)

Факс: 8 (812) 320-02-42

Электронная почта: org@eplast1.ru

Адрес: 198099, г. Санкт-Петербург, ул. Калинина, дом 2, корпус 4, литера А.