

POWER RELAY

1 POLE - 6A (MEDIUM LOAD CONTROL)

SLIM TYPE

FTR-LY Series

RoHS compliant

■ **FEATURES**

- Slim(15.0mm(h) x 5.0 mm(w) x 28.0mm (l))
- 1 form C available
- Mounting space: 140mm², weight: 5.0g
- High insulation in small package
 - Insulation Distance (Between coil and contacts): 8mm (crepage/clearance)
 - Dielectric strength: 4,000 VAC
 - Surge strength: 6,000V
- UL, CSA, VDE, SEMKO, FIMKO, DEMKO, NEMKO compliance
- Contains no lead and features cadmium-free contacts
- Socket type available
- RoHS Compliant
Please see page 9 for more information
- Plastic sealed



■ **ORDERING INFORMATION**

[Example] $\frac{\text{FTR-LY}}{(a)}$ $\frac{\text{A}}{(b)}$ $\frac{\text{A}}{(c)}$ $\frac{\text{005}}{(d)}$ $\frac{\text{Y}}{(e)}$ $\frac{\text{SK}}{(f)}$

(a)	Series Name	FTR-LY : FTR-LY Series	
(b)	Contact Arrangement	A : 1 form A C : 1 form C	P: 1 form A (Right Angle Type) R: 1 form C (Right Angle Type)
(c)	Coil Type	A : Standard (170 mW)	
(d)	Nominal Voltage	005 : 5 VDC, 012 : 12VDC,	006 : 6VDC, (refer to COIL DATA chart) 024 : 24VDC, 048 : 48VDC
(e)	Contact Material	E : AgNi Y : AgSnO2 V : AgSnO2 + Au (0.3μm)	
(f)	Socket Type	Nil : PCB mounting type SK : Socket mounting type (contact arrangement A and C only)	

Actual marking does not carry the type name : "FTR" and "SK"
 E.g.: Ordering code: FTR-LYAA012Y Actual marking: LYAA012Y

FTR-LY SERIES

■ PART NUMBERS

Ordering P/N	Series	Contact	Coil Power	Coil Voltage	Contact		
FTR-LY(A,P)A005Y	FTR-LY	1 form A	170 mW	5	Y: AgSnO ₂		
FTR-LY(A,P)A006Y				6			
FTR-LY(A,P)A009Y				9			
FTR-LY(A,P)A012Y				12			
FTR-LY(A,P)A018Y				18			
FTR-LY(A,P)A024Y				24			
FTR-LY(A,P)A048Y			217 mW	48			
FTR-LY(A,P)A060Y			175 mW	60			
FTR-LY(C,R)A005Y			1 form C	170 mW		5	
FTR-LY(C,R)A006Y		6					
FTR-LY(C,R)A009Y		9					
FTR-LY(C,R)A012Y		12					
FTR-LY(C,R)A018Y		18					
FTR-LY(C,R)A024Y		24					
FTR-LY(C,R)A048Y		217 mW		48			
FTR-LY(C,R)A060Y		175 mW		60			
FTR-LY(A,P)A005V		FTR-LY		1 form A		170 mW	5
FTR-LY(A,P)A006V			6				
FTR-LY(A,P)A009V			9				
FTR-LY(A,P)A012V			12				
FTR-LY(A,P)A018V			18				
FTR-LY(A,P)A024V			24				
FTR-LY(A,P)A048V			217 mW			48	
FTR-LY(A,P)A060V			175 mW			60	
FTR-LY(C,R)A005V			1 form C			170 mW	5
FTR-LY(C,R)A006V				6			
FTR-LY(C,R)A009V				9			
FTR-LY(C,R)A012V				12			
FTR-LY(C,R)A018V				18			
FTR-LY(C,R)A024V				24			
FTR-LY(C,R)A048V	217 mW			48			
FTR-LY(C,R)A060V	175 mW			60			
FTR-LY(A,P)A005E	FTR-LY			1 form A	170 mW	5	E: AgNi
FTR-LY(A,P)A006E			6				
FTR-LY(A,P)A009E		9					
FTR-LY(A,P)A012E		12					
FTR-LY(A,P)A018E		18					
FTR-LY(A,P)A024E		24					
FTR-LY(A,P)A048E		217 mW	48				
FTR-LY(A,P)A060E		175 mW	60				
FTR-LY(C,R)A005E		1 form C	170 mW		5		
FTR-LY(C,R)A006E				6			
FTR-LY(C,R)A009E				9			
FTR-LY(C,R)A012E				12			
FTR-LY(C,R)A018E				18			
FTR-LY(C,R)A024E				24			
FTR-LY(C,R)A048E			217 mW	48			
FTR-LY(C,R)A060E			175 mW	60			

FTR-LY SERIES

■ COIL DATA CHART

Coil Voltage	Nominal Voltage	Max. Coil Voltage* ¹	Coil Resistance (±10%)	Must Operate Voltage* ²	Must Release Voltage	Nominal Power
5	5 VDC	11.5 VDC	147 Ω	3.3 VDC	0.25 VDC	170 mW
6	6 VDC	13.8 VDC	211 Ω	4.0 VDC	0.3 VDC	170 mW
9	9 VDC	20.7 VDC	476 Ω	5.9 VDC	0.45 VDC	170 mW
12	12 VDC	27.6 VDC	847 Ω	7.9 VDC	0.6 VDC	170 mW
18	18 VDC	41.4 VDC	1,910 Ω	11.9 VDC	0.9 VDC	170 mW
24	24 VDC	55.2 VDC	3,390 Ω	15.9 VDC	1.2 VDC	170 mW
48	48 VDC	110.4 VDC	10,600 Ω	31.7 VDC	2.4 VDC	217 mW
60	60 VDC	138.0 VDC	20,570 Ω	39.6 VDC	3.0 VDC	175 mW

Note: All values in the table are measured at 20°C.

*1: No contact current at 20°C

*2: Specified values are subject to pulse wave voltage

■ SPECIFICATIONS

Item		FTR-LY (C, R) A (), (Y, E, V)	FTR-LY (A, P) A (), (Y, E, V)	
Contact	Arrangement	1 form C		
	Material	Y: AgSnO ₂ , E: AgNi, V: AgSnO ₂ + Au 0.3μm		
	Resistance (initial)	Y, E: Maximum 100 mΩ at 6 VDC, 1 A V: Maximum 30 mΩ at 6 VDC, 1A		
	Rating	6 A, 250 VAC / 24 VDC		
	Maximum Carrying Current	6A		
	Maximum Switching Power	1,500 VA / 144 W		
	Maximum Switching Voltage	250 VAC		
	Minimum Switching Load* ¹	Y, E: 100 mA 5 VDC V: 10mA 5 VDC		
Coil	Operating Temperature	-40°C to +85°C (no frost)		
	Nominal Power	170 to 217 mW		
	Must Operate Power	74 to 76 mW		
Time Value	Operate Time (without diode)	Maximum 8 ms (at nominal voltage, no bounce)		
	Release Time (without diode)	Maximum 4 ms (at nominal voltage, no bounce)		
Life	Mechanical	10 x 10 ⁶ operations minimum		
	Electrical	50 x 10 ³ operations min. (N.O.) 30 x 10 ³ operations min. (N.C.) at 6 A, 250VAC/30VDC resistive		
Other	Vibration Resistance	Misoperation	10 to 55 Hz, at double amplitude of 1,0 mm	
		Endurance	10-55Hz, at double amplitude of 1.5 mm	
	Shock Resistance	Misoperation	Min. 50m/s ² (11±1ms)	Min. 100m/s ² (11±1ms)
		Endurance	Min. 1,000m/s ² (6±1ms)	
Weight	Approximately 5g			

*¹ Minimum switching loads mentioned above are reference values. Please perform the confirmation test with the actual load before production since reference values may vary according to switching frequencies, environmental conditions and expected reliability levels.

FTR-LY SERIES

■ INSULATION

Item	FTR-LY	
Resistance (at 500 VDC)	Minimum 1,000 MΩ 1 min.	
Dielectric Strength	open contacts	1,000 VAC (50/60 Hz) 1 min. 10mA detection current
	coil and contacts	4,000 VAC (50/60 Hz) 1 min. 10mA detection current
Surge Voltage (coil and contact)	6,000 V (1.2 x 50µs standard wave)	
Clearance/Creepage	8 mm / 8 mm	
(DIN EN61810-1 VDE0435)		
Voltage	250 V	
Pollution	3	
Isolation material group	IIIa	
Isolation category / Reference voltage (VDE01106)	C / 250 V	

■ SAFETY STANDARDS

Type	Compliance	Contact rating
UL	UL 508	Flammability: UL 94-V0 (plastics) 5A, 277 VAC (resistive) 5A, 30 VDC (resistive)
	E63614	
CSA	C22.2 No. 14 LR 40304	1/10 HP, 277VAC /125VAC Pilot duty: D300, C300, R300
VDE 40006591	EN 61810-1 (VDE 0435-Port 201) 2004-07 EN 61984 (VDE 0627) EN 60730-1 (VDE 0631-Port 1) EN 60335-1 (VDE 0700-Port 1)	250VAC;6A 30VDC;6A 250VAC;6(1,5) 250VAC;3(1,5)
SEMKO	EN 61058-1:1992+A1 EN 61095:1993+A1+A11	250V, 6(3)A

FTR-LY SERIES

REFERENCE DATA

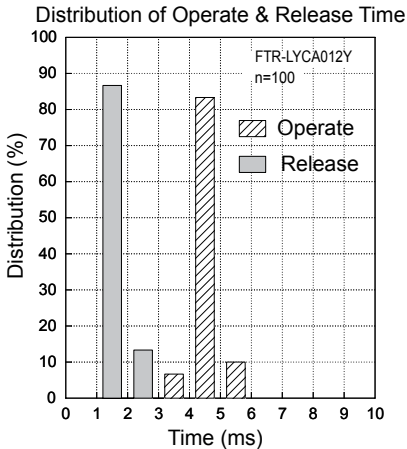
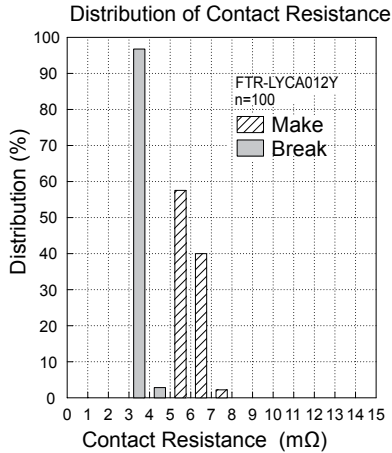
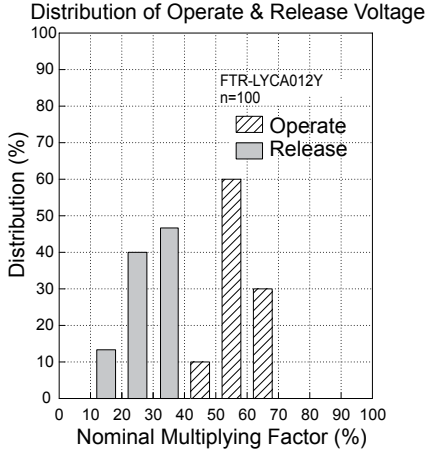
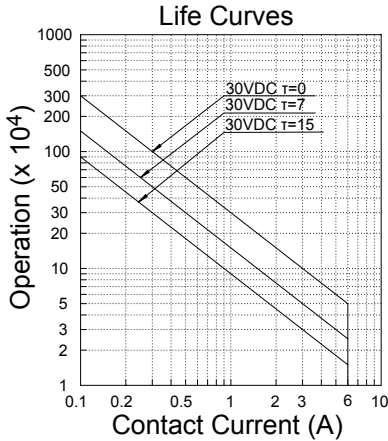
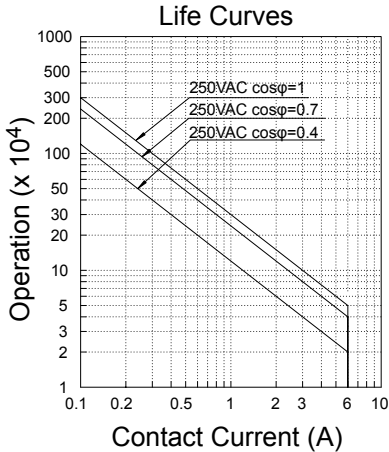
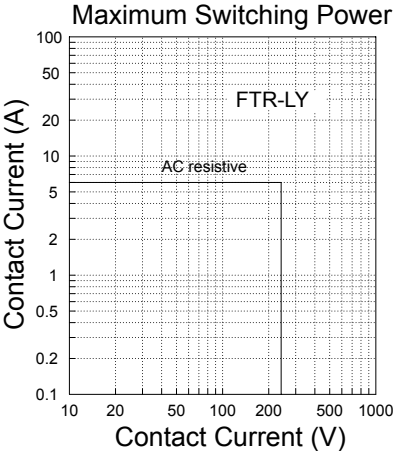
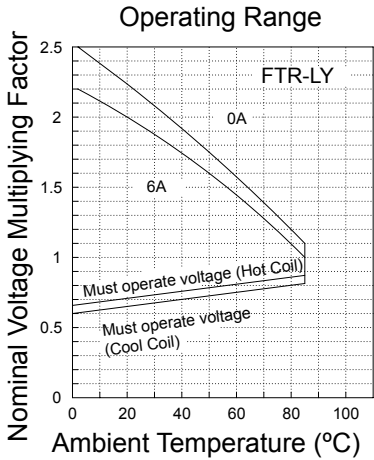
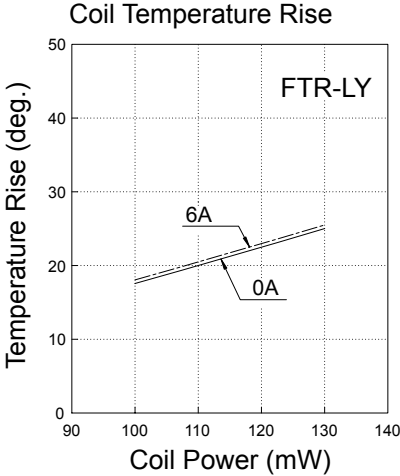

FTR-LY SERIES

■ DIMENSIONS

Thru hole type

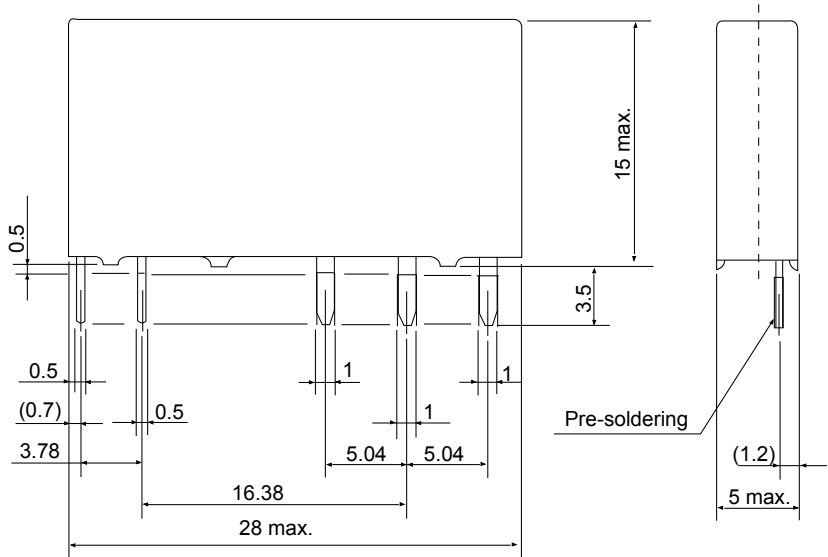

Drilling Plan (BOTTOM VIEW)

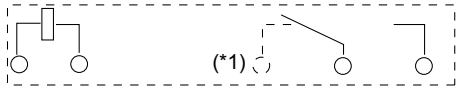

Wiring Diagram (BOTTOM VIEW)

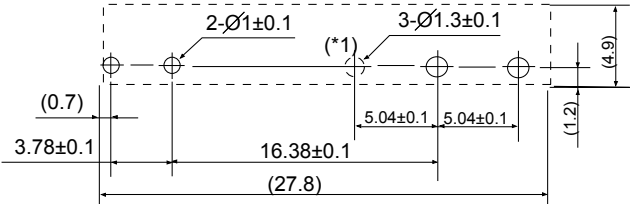

*1: This terminal is not applicable for 1 form A type

Unit: mm

FTR-LY SERIES

■ DIMENSIONS

Right Angle type

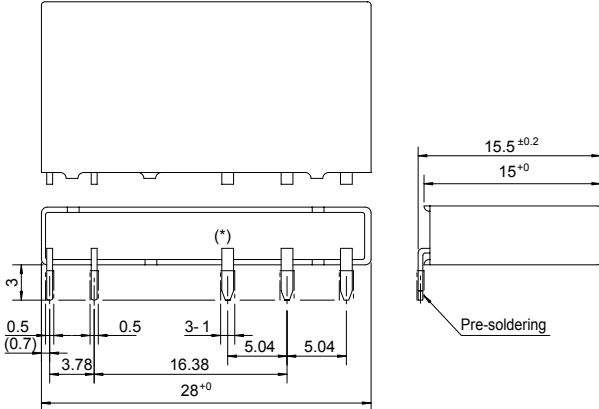

Drilling Plan (BOTTOM VIEW)

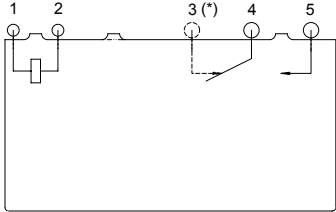

Wiring Diagram (BOTTOM VIEW)

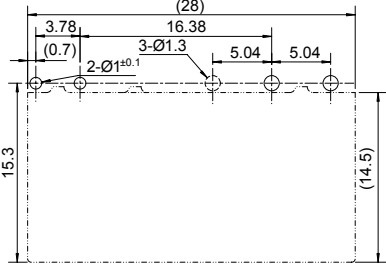

*: This terminal is not applicable for 1 form A type

Unit: mm

FTR-LY SERIES

■ DIMENSIONS

Socket type

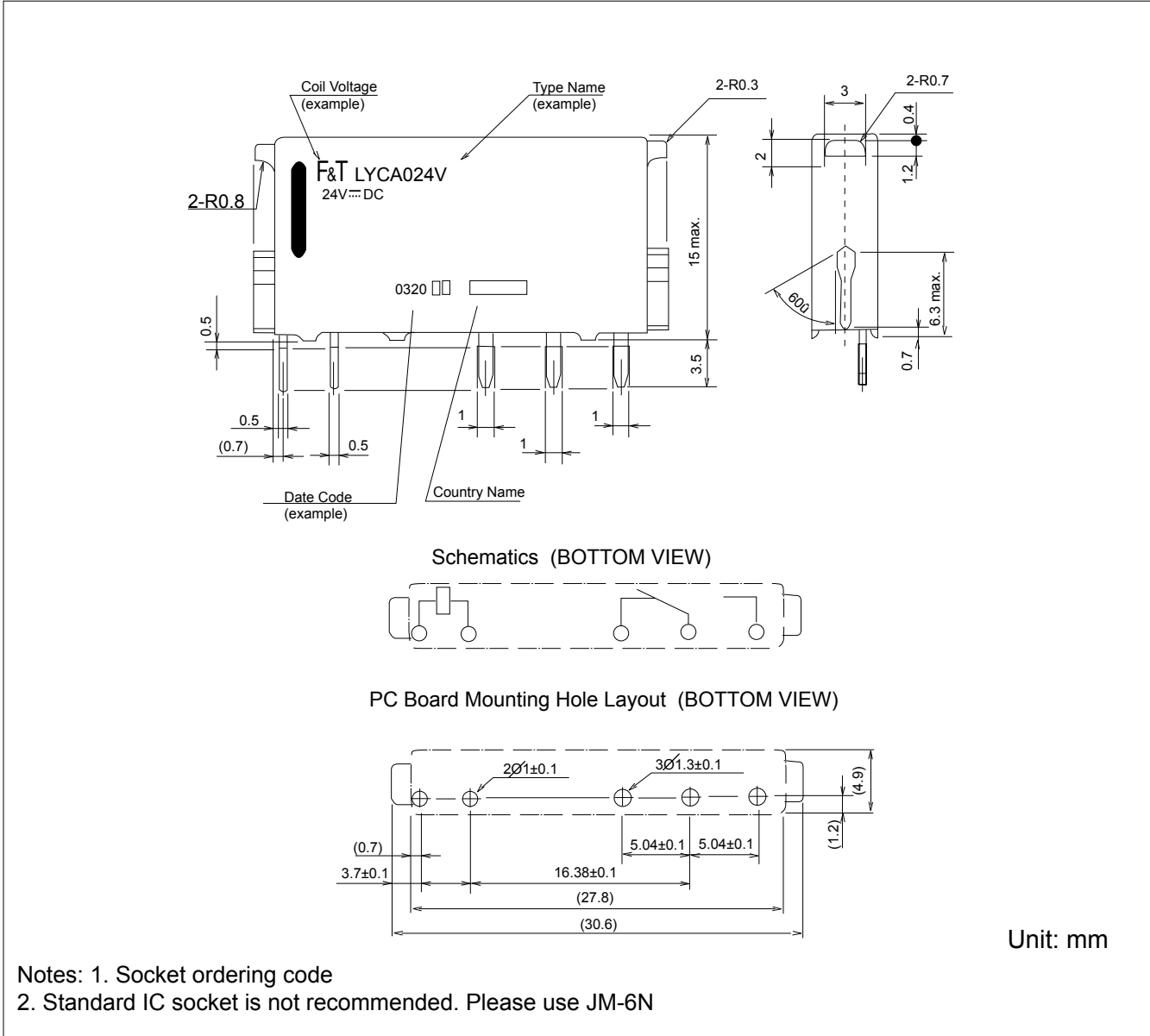

Unit: mm

- Notes: 1. Socket ordering code
- 2. Standard IC socket is not recommended. Please use JM-6N

RoHS Compliance and Lead Free Relay Information

1. General Information

- Relays produced after the specific date code that is indicated on each data sheet are RoHS-compliant now. Please refer to RoHS-compliant Status Info.
(<http://www.fujitsu.com/us/downloads/MICRO/fcai/relays/lead-free-letter.pdf>)
- Lead free solder paste currently used in relays is Sn-3.0Ag-0.5Cu.
- Relays that are RoHS compliant do not contain the 5 hazardous materials that are restricted by RoHS directive (lead, mercury, chromium IV, PBB, PBDE and DecaBDE).
- It has been verified that using lead-free relays in leaded assembly process will not cause any problems (compatible).
- "LF" is marked on each outer and inner carton. (No marking on individual relays).

Note: Cadmium was exempted from RoHS on October 21, 2005. (Amendment to Directive 2002/95/EC)

2. Recommended Lead Free Solder Profile

- Recommended solder paste Sn-3.0Ag-0.5Cu.

Solder condition

Flow Solder condition:

Pre-heating: maximum 120°C
Soldering: dip within 5 sec. at
260°C solder bath

Solder by Soldering Iron:

Soldering Iron
Temperature: maximum 360°C
Duration: maximum 3 sec.

We highly recommend that you confirm your actual solder conditions

3. Moisture Sensitivity

- Moisture Sensitivity Level standard is not applicable to electromechanical relays.

4. Tin Whisker

- Dipped SnAgCu solder is known as low risk tin whisker. No considerable length whisker was found by our in house test.

Fujitsu Components International Headquarter Offices

Japan

Fujitsu Component Limited
Gotanda-Chuo Building
3-5, Higashigotanda 2-chome, Shinagawa-ku
Tokyo 141, Japan
Tel: (81-3) 5449-7010
Fax: (81-3) 5449-2626
Email: promothq@ft.ed.fujitsu.com
Web: www.fcl.fujitsu.com

North and South America

Fujitsu Components America, Inc.
250 E. Caribbean Drive
Sunnyvale, CA 94089 U.S.A.
Tel: (1-408) 745-4900
Fax: (1-408) 745-4970
Email: components@us.fujitsu.com
Web: <http://www.fujitsu.com/us/services/edevices/components/>

Europe

Fujitsu Components Europe B.V.
Diamantlaan 25
2132 WV Hoofddorp
Netherlands
Tel: (31-23) 5560910
Fax: (31-23) 5560950
Email: info@fceu.fujitsu.com
Web: emea.fujitsu.com/components/

Asia Pacific

Fujitsu Components Asia Ltd.
102E Pasir Panjang Road
#01-01 Citilink Warehouse Complex
Singapore 118529
Tel: (65) 6375-8560
Fax: (65) 6273-3021
Email: fcsl@fcal.fujitsu.com
Web: <http://www.fujitsu.com/sg/services/micro/components/>

©2009 Fujitsu Components America, Inc. All rights reserved. All trademarks or registered trademarks are the property of their respective owners.

Fujitsu Components America or its affiliates do not warrant that the content of datasheet is error free. In a continuing effort to improve our products Fujitsu Components America, Inc. or its affiliates reserve the right to change specifications/datasheets without prior notice.
Rev. February 2, 2009.



Компания «ЭлектроПласт» предлагает заключение долгосрочных отношений при поставках импортных электронных компонентов на взаимовыгодных условиях!

Наши преимущества:

- Оперативные поставки широкого спектра электронных компонентов отечественного и импортного производства напрямую от производителей и с крупнейших мировых складов;
- Поставка более 17-ти миллионов наименований электронных компонентов;
- Поставка сложных, дефицитных, либо снятых с производства позиций;
- Оперативные сроки поставки под заказ (от 5 рабочих дней);
- Экспресс доставка в любую точку России;
- Техническая поддержка проекта, помощь в подборе аналогов, поставка прототипов;
- Система менеджмента качества сертифицирована по Международному стандарту ISO 9001;
- Лицензия ФСБ на осуществление работ с использованием сведений, составляющих государственную тайну;
- Поставка специализированных компонентов (Xilinx, Altera, Analog Devices, Intersil, Interpoint, Microsemi, Aeroflex, Peregrine, Syfer, Eurofarad, Texas Instrument, Miteq, Cobham, E2V, MA-COM, Hittite, Mini-Circuits, General Dynamics и др.);

Помимо этого, одним из направлений компании «ЭлектроПласт» является направление «Источники питания». Мы предлагаем Вам помощь Конструкторского отдела:

- Подбор оптимального решения, техническое обоснование при выборе компонента;
- Подбор аналогов;
- Консультации по применению компонента;
- Поставка образцов и прототипов;
- Техническая поддержка проекта;
- Защита от снятия компонента с производства.



Как с нами связаться

Телефон: 8 (812) 309 58 32 (многоканальный)

Факс: 8 (812) 320-02-42

Электронная почта: org@eplast1.ru

Адрес: 198099, г. Санкт-Петербург, ул. Калинина, дом 2, корпус 4, литера А.