

POWER RELAY

1 POLE - 6A (MEDIUM LOAD CONTROL)

SLIM TYPE

FTR-LY Series

RoHS compliant

FEATURES

- Slim(15.0mm(h) x 5.0 mm(w) x 28.0mm (l))
- 1 form C available
- Mounting space: 140mm², weight: 5.0g
- High insulation in small package
 - Insulation Distance (Between coil and contacts): 8mm (crepage/clearance)
 - Dielectric strength: 4,000 VAC
 - Surge strength: 6,000V
- UL, CSA, VDE, SEMKO, FIMKO, DEMKO, NEMKO compliance
- Contains no lead and features cadmium-free contacts
- Socket type available
- RoHS Compliant
 - Please see page 9 for more information
- Plastic sealed



ORDERING INFORMATION

[Example] $\frac{\text{FTR-LY}}{\text{(a)}}$ $\frac{\text{A}}{\text{(b)}}$ $\frac{\text{A}}{\text{(c)}}$ $\frac{\text{005}}{\text{(d)}}$ $\frac{\text{Y}}{\text{(e)}}$ $\frac{\text{SK}}{\text{(f)}}$

| | | |
|-----|---------------------|--|
| (a) | Series Name | FTR-LY : FTR-LY Series |
| (b) | Contact Arrangement | A : 1 form A P: 1 form A (Right Angle Type) C : 1 form C R: 1 form C (Right Angle Type) |
| (c) | Coil Type | A : Standard (170 mW) |
| (d) | Nominal Voltage | 005 : 5 VDC, 006 : 6VDC, (refer to COIL DATA chart) 012 : 12VDC, 024 : 24VDC, 048 : 48VDC |
| (e) | Contact Material | E : AgNi Y : AgSnO ₂ V : AgSnO ₂ + Au (0.3µm) |
| (f) | Socket Type | Nil : PCB mounting type SK : Socket mounting type (contact arrangement A and C only) |

Actual marking does not carry the type name : "FTR" and "SK"

E.g.: Ordering code: FTR-LYAA012Y

Actual marking: LYAA012Y

FTR-LY SERIES

■ PART NUMBERS

| Ordering P/N | Series | Contact | Coil Power | Coil Voltage | Contact | | |
|------------------|--------|----------|------------|--------------|-----------|--------|---------|
| FTR-LY(A,P)A005Y | FTR-LY | 1 form A | 170 mW | 5 | Y: AgSnO2 | | |
| FTR-LY(A,P)A006Y | | | | 6 | | | |
| FTR-LY(A,P)A009Y | | | | 9 | | | |
| FTR-LY(A,P)A012Y | | | | 12 | | | |
| FTR-LY(A,P)A018Y | | | | 18 | | | |
| FTR-LY(A,P)A024Y | | | | 24 | | | |
| FTR-LY(A,P)A048Y | | | 217 mW | 48 | | | |
| FTR-LY(A,P)A060Y | | | 175 mW | 60 | | | |
| FTR-LY(C,R)A005Y | | | 1 form C | 170 mW | | 5 | |
| FTR-LY(C,R)A006Y | | 6 | | | | | |
| FTR-LY(C,R)A009Y | | 9 | | | | | |
| FTR-LY(C,R)A012Y | | 12 | | | | | |
| FTR-LY(C,R)A018Y | | 18 | | | | | |
| FTR-LY(C,R)A024Y | | 24 | | | | | |
| FTR-LY(C,R)A048Y | | 217 mW | | 48 | | | |
| FTR-LY(C,R)A060Y | | 175 mW | | 60 | | | |
| FTR-LY(A,P)A005V | | FTR-LY | | 1 form A | | 170 mW | 5 |
| FTR-LY(A,P)A006V | | | 6 | | | | |
| FTR-LY(A,P)A009V | | | 9 | | | | |
| FTR-LY(A,P)A012V | | | 12 | | | | |
| FTR-LY(A,P)A018V | | | 18 | | | | |
| FTR-LY(A,P)A024V | | | 24 | | | | |
| FTR-LY(A,P)A048V | | | 217 mW | | 48 | | |
| FTR-LY(A,P)A060V | | | 175 mW | | 60 | | |
| FTR-LY(C,R)A005V | | | 1 form C | | 170 mW | 5 | |
| FTR-LY(C,R)A006V | | | | 6 | | | |
| FTR-LY(C,R)A009V | | | | 9 | | | |
| FTR-LY(C,R)A012V | | | | 12 | | | |
| FTR-LY(C,R)A018V | | | | 18 | | | |
| FTR-LY(C,R)A024V | | | | 24 | | | |
| FTR-LY(C,R)A048V | 217 mW | | | 48 | | | |
| FTR-LY(C,R)A060V | 175 mW | | | 60 | | | |
| FTR-LY(A,P)A005E | FTR-LY | | | 1 form A | 170 mW | 5 | E: AgNi |
| FTR-LY(A,P)A006E | | | 6 | | | | |
| FTR-LY(A,P)A009E | | 9 | | | | | |
| FTR-LY(A,P)A012E | | 12 | | | | | |
| FTR-LY(A,P)A018E | | 18 | | | | | |
| FTR-LY(A,P)A024E | | 24 | | | | | |
| FTR-LY(A,P)A048E | | 217 mW | 48 | | | | |
| FTR-LY(A,P)A060E | | 175 mW | 60 | | | | |
| FTR-LY(C,R)A005E | | 1 form C | 170 mW | | 5 | | |
| FTR-LY(C,R)A006E | | | | 6 | | | |
| FTR-LY(C,R)A009E | | | | 9 | | | |
| FTR-LY(C,R)A012E | | | | 12 | | | |
| FTR-LY(C,R)A018E | | | | 18 | | | |
| FTR-LY(C,R)A024E | | | | 24 | | | |
| FTR-LY(C,R)A048E | | | 217 mW | 48 | | | |
| FTR-LY(C,R)A060E | | | 175 mW | 60 | | | |

FTR-LY SERIES

■ COIL DATA CHART

| Coil Voltage | Nominal Voltage | Max. Coil Voltage* ¹ | Coil Resistance (±10%) | Must Operate Voltage* ² | Must Release Voltage | Nominal Power |
|--------------|-----------------|---------------------------------|------------------------|------------------------------------|----------------------|---------------|
| 5 | 5 VDC | 11.5 VDC | 147 Ω | 3.3 VDC | 0.25 VDC | 170 mW |
| 6 | 6 VDC | 13.8 VDC | 211 Ω | 4.0 VDC | 0.3 VDC | 170 mW |
| 9 | 9 VDC | 20.7 VDC | 476 Ω | 5.9 VDC | 0.45 VDC | 170 mW |
| 12 | 12 VDC | 27.6 VDC | 847 Ω | 7.9 VDC | 0.6 VDC | 170 mW |
| 18 | 18 VDC | 41.4 VDC | 1,910 Ω | 11.9 VDC | 0.9 VDC | 170 mW |
| 24 | 24 VDC | 55.2 VDC | 3,390 Ω | 15.9 VDC | 1.2 VDC | 170 mW |
| 48 | 48 VDC | 110.4 VDC | 10,600 Ω | 31.7 VDC | 2.4 VDC | 217 mW |
| 60 | 60 VDC | 138.0 VDC | 20,570 Ω | 39.6 VDC | 3.0 VDC | 175 mW |

Note: All values in the table are measured at 20°C.

*1: No contact current at 20°C

*2: Specified values are subject to pulse wave voltage

■ SPECIFICATIONS

| Item | | FTR-LY (C, R) A (), (Y, E, V) | FTR-LY (A, P) A (), (Y, E, V) | |
|------------|--------------------------------------|---|--|-----------------------------------|
| Contact | Arrangement | 1 form C | | |
| | Material | Y: AgSnO ₂ , E: AgNi, V: AgSnO ₂ + Au 0.3μm | | |
| | Resistance (initial) | Y, E: Maximum 100 mΩ at 6 VDC, 1 A V: Maximum 30 mΩ at 6 VDC, 1A | | |
| | Rating | 6 A, 250 VAC / 24 VDC | | |
| | Maximum Carrying Current | 6A | | |
| | Maximum Switching Power | 1,500 VA / 144 W | | |
| | Maximum Switching Voltage | 250 VAC | | |
| | Minimum Switching Load* ¹ | Y, E: 100 mA 5 VDC V: 10mA 5 VDC | | |
| Coil | Operating Temperature | -40°C to +85°C (no frost) | | |
| | Nominal Power | 170 to 217 mW | | |
| | Must Operate Power | 74 to 76 mW | | |
| Time Value | Operate Time (without diode) | Maximum 8 ms (at nominal voltage, no bounce) | | |
| | Release Time (without diode) | Maximum 4 ms (at nominal voltage, no bounce) | | |
| Life | Mechanical | 10 x 10 ⁶ operations minimum | | |
| | Electrical | 50 x 10 ³ operations min. (N.O.) 30 x 10 ³ operations min. (N.C.) at 6 A, 250VAC/30VDC resistive | | |
| Other | Vibration Resistance | Misoperation | 10 to 55 Hz, at double amplitude of 1,0 mm | |
| | | Endurance | 10-55Hz, at double amplitude of 1.5 mm | |
| | Shock Resistance | Misoperation | Min. 50m/s ² (11±1ms) | Min. 100m/s ² (11±1ms) |
| | | Endurance | Min. 1,000m/s ² (6±1ms) | |
| Weight | Approximately 5g | | | |

*¹ Minimum switching loads mentioned above are reference values. Please perform the confirmation test with the actual load before production since reference values may vary according to switching frequencies, environmental conditions and expected reliability levels.

FTR-LY SERIES

■ INSULATION

| | | |
|---|------------------------------------|--|
| Item | FTR-LY | |
| Resistance (at 500 VDC) | Minimum 1,000 MΩ 1 min. | |
| Dielectric Strength | open contacts | 1,000 VAC (50/60 Hz) 1 min. 10mA detection current |
| | coil and contacts | 4,000 VAC (50/60 Hz) 1 min. 10mA detection current |
| Surge Voltage (coil and contact) | 6,000 V (1.2 x 50µs standard wave) | |
| Clearance/Creepage | 8 mm / 8 mm | |
| (DIN EN61810-1 VDE0435) | | |
| Voltage | 250 V | |
| Pollution | 3 | |
| Isolation material group | IIIa | |
| Isolation category / Reference voltage (VDE01106) | C / 250 V | |

■ SAFETY STANDARDS

| Type | Compliance | Contact rating |
|-----------------|---|--|
| UL | UL 508 | Flammability: UL 94-V0 (plastics) 5A, 277 VAC (resistive) 5A, 30 VDC (resistive) |
| | E63614 | |
| CSA | C22.2 No. 14 LR 40304 | 1/10 HP, 277VAC /125VAC Pilot duty: D300, C300, R300 |
| VDE 40006591 | EN 61810-1 (VDE 0435-Port 201) 2004-07 EN 61984 (VDE 0627) EN 60730-1 (VDE 0631-Port 1) EN 60335-1 (VDE 0700-Port 1) | 250VAC;6A 30VDC;6A 250VAC;6(1,5) 250VAC;3(1,5) |
| SEMKO | EN 61058-1:1992+A1 EN 61095:1993+A1+A11 | 250V, 6(3)A |

FTR-LY SERIES

■ REFERENCE DATA

Coil Temperature Rise

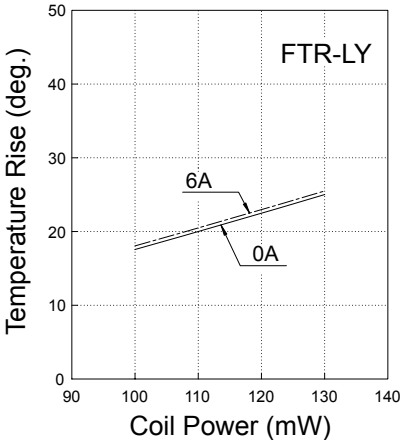

Operating Range

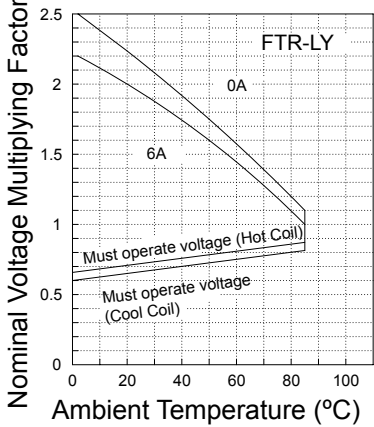

Maximum Switching Power

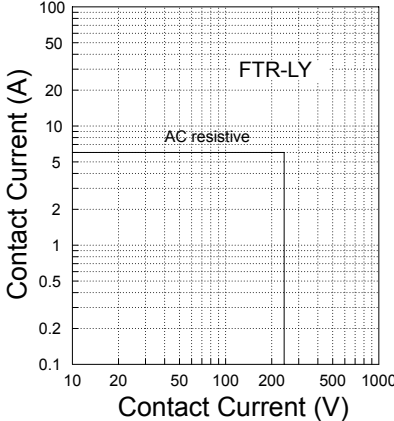

Life Curves

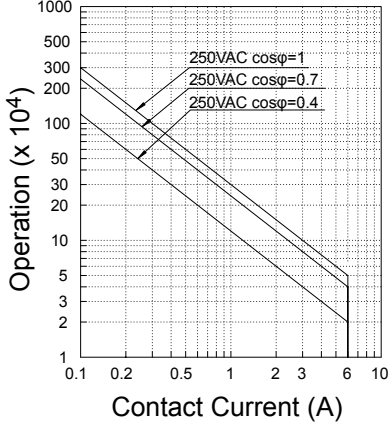

Life Curves

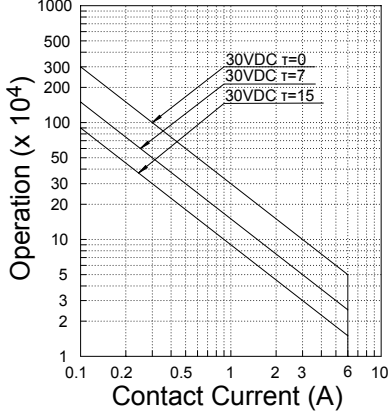

Distribution of Operate & Release Voltage

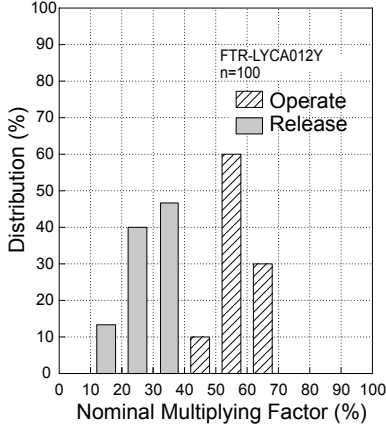

Distribution of Contact Resistance

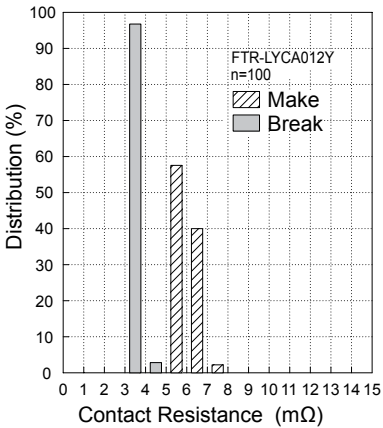

Distribution of Operate & Release Time

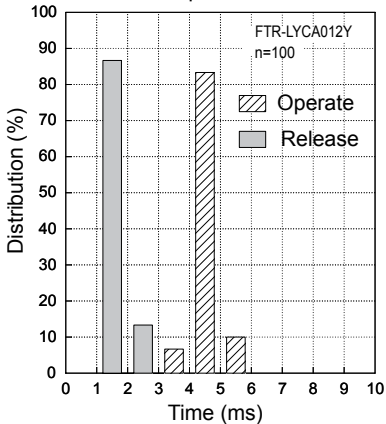

FTR-LY SERIES

■ DIMENSIONS

Thru hole type

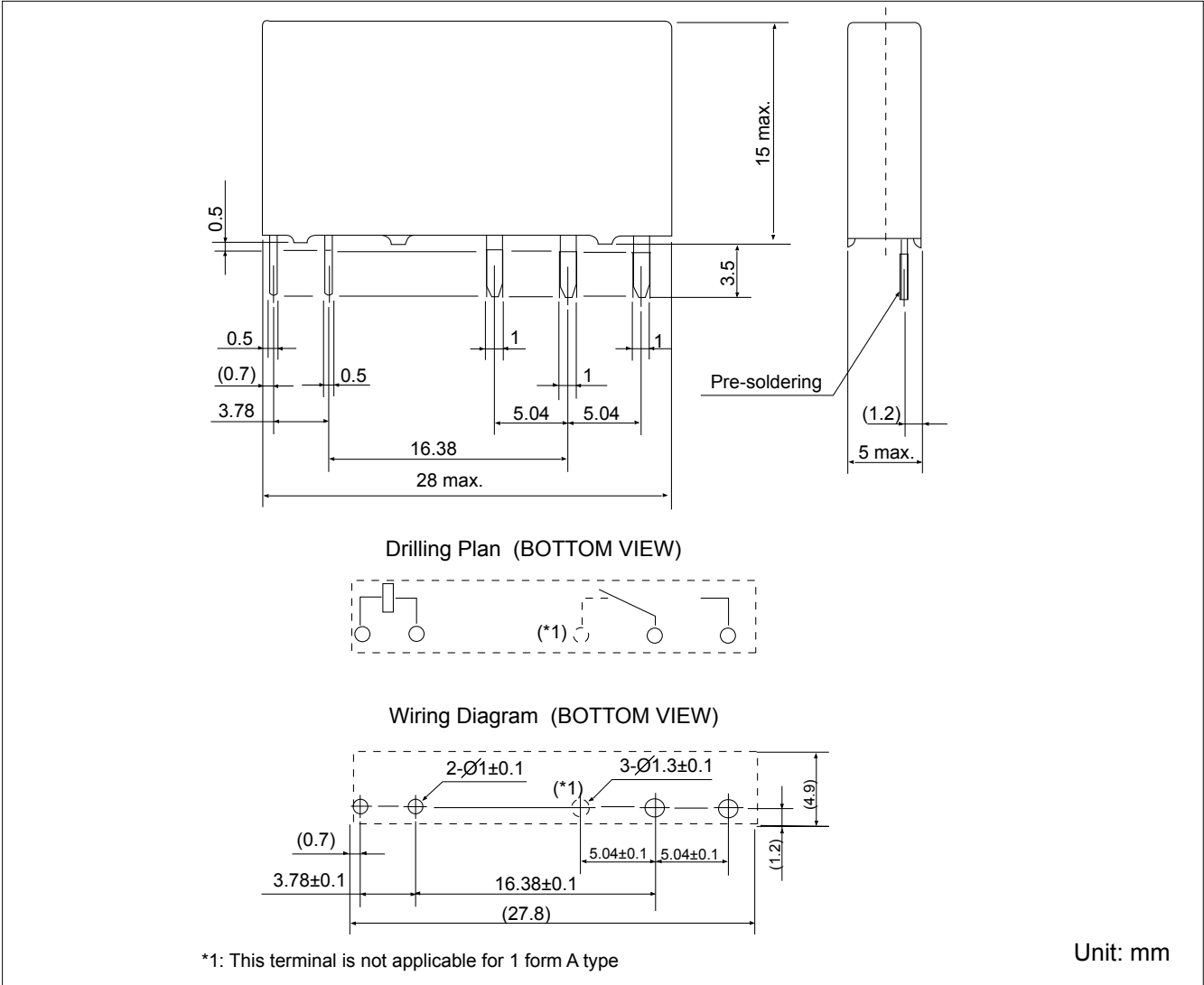

*1: This terminal is not applicable for 1 form A type

FTR-LY SERIES

■ DIMENSIONS

Right Angle type

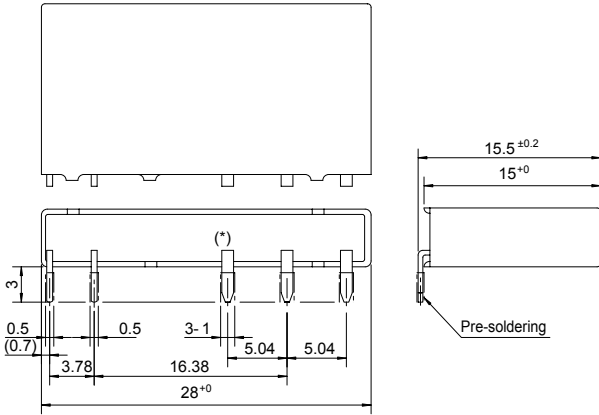

Drilling Plan (BOTTOM VIEW)

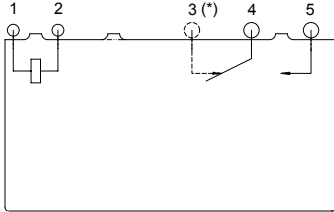

Wiring Diagram (BOTTOM VIEW)

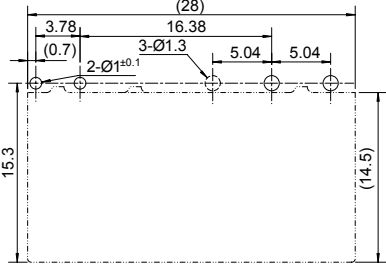

*: This terminal is not applicable for 1 form A type

Unit: mm

FTR-LY SERIES

■ DIMENSIONS

Socket type

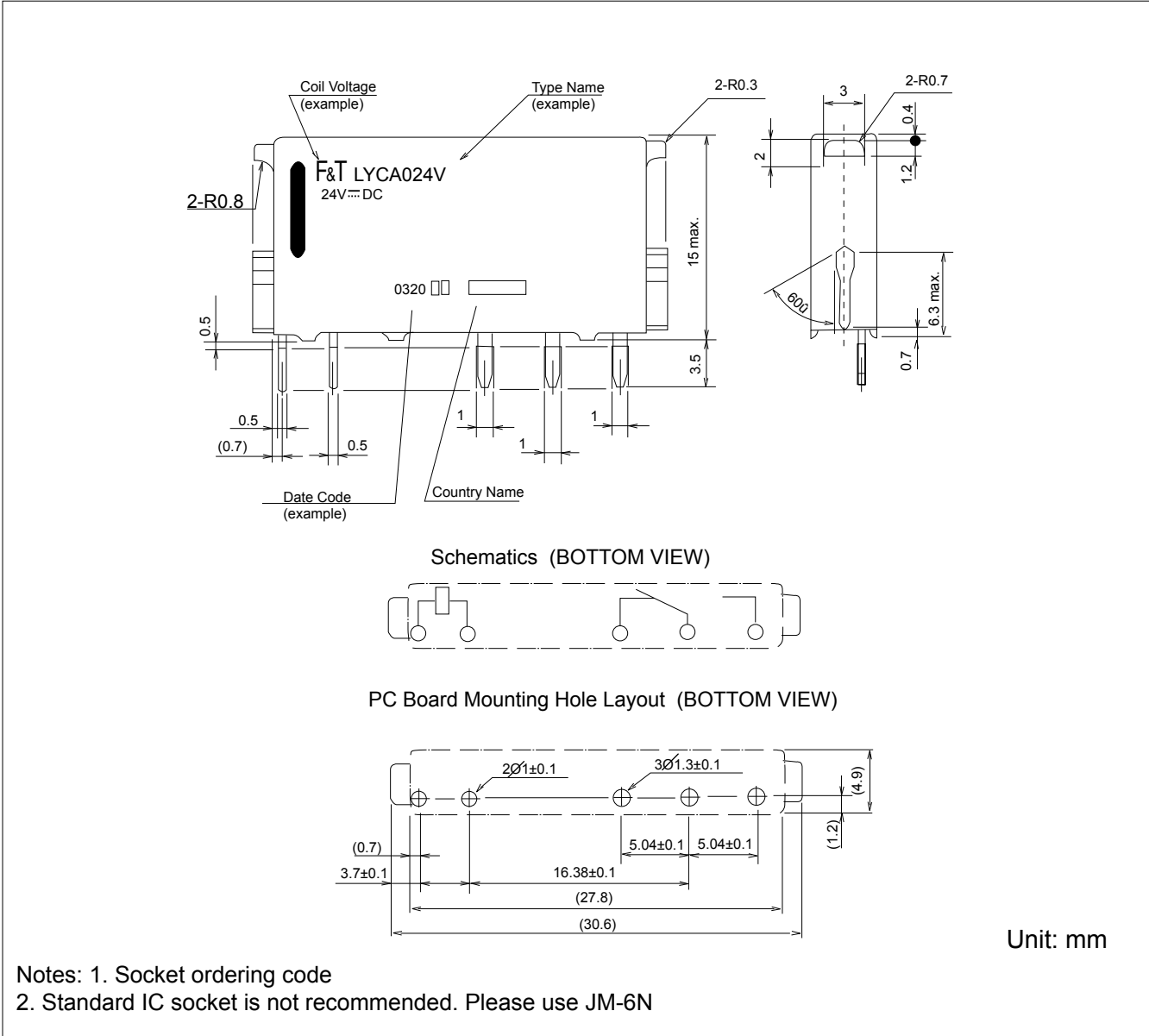

RoHS Compliance and Lead Free Relay Information

1. General Information

- Relays produced after the specific date code that is indicated on each data sheet are RoHS-compliant now. Please refer to RoHS-compliant Status Info.
(<http://www.fujitsu.com/us/downloads/MICRO/fcai/relays/lead-free-letter.pdf>)
- Lead free solder paste currently used in relays is Sn-3.0Ag-0.5Cu.
- Relays that are RoHS compliant do not contain the 5 hazardous materials that are restricted by RoHS directive (lead, mercury, chromium IV, PBB, PBDE and DecaBDE).
- It has been verified that using lead-free relays in leaded assembly process will not cause any problems (compatible).
- "LF" is marked on each outer and inner carton. (No marking on individual relays).

Note: Cadmium was exempted from RoHS on October 21, 2005. (Amendment to Directive 2002/95/EC)

2. Recommended Lead Free Solder Profile

- Recommended solder paste Sn-3.0Ag-0.5Cu.

Solder condition

Flow Solder condition:

Pre-heating: maximum 120°C
Soldering: dip within 5 sec. at
260°C solder bath

Solder by Soldering Iron:

Soldering Iron
Temperature: maximum 360°C
Duration: maximum 3 sec.

We highly recommend that you confirm your actual solder conditions

3. Moisture Sensitivity

- Moisture Sensitivity Level standard is not applicable to electromechanical relays.

4. Tin Whisker

- Dipped SnAgCu solder is known as low risk tin whisker. No considerable length whisker was found by our in house test.

Fujitsu Components International Headquarter Offices

Japan

Fujitsu Component Limited
Gotanda-Chuo Building
3-5, Higashigotanda 2-chome, Shinagawa-ku
Tokyo 141, Japan
Tel: (81-3) 5449-7010
Fax: (81-3) 5449-2626
Email: promothq@ft.ed.fujitsu.com
Web: www.fcl.fujitsu.com

North and South America

Fujitsu Components America, Inc.
250 E. Caribbean Drive
Sunnyvale, CA 94089 U.S.A.
Tel: (1-408) 745-4900
Fax: (1-408) 745-4970
Email: components@us.fujitsu.com
Web: <http://www.fujitsu.com/us/services/edevices/components/>

Europe

Fujitsu Components Europe B.V.
Diamantlaan 25
2132 WV Hoofddorp
Netherlands
Tel: (31-23) 5560910
Fax: (31-23) 5560950
Email: info@fceu.fujitsu.com
Web: emea.fujitsu.com/components/

Asia Pacific

Fujitsu Components Asia Ltd.
102E Pasir Panjang Road
#01-01 Citilink Warehouse Complex
Singapore 118529
Tel: (65) 6375-8560
Fax: (65) 6273-3021
Email: fcsl@fcal.fujitsu.com
Web: <http://www.fujitsu.com/sg/services/micro/components/>

©2009 Fujitsu Components America, Inc. All rights reserved. All trademarks or registered trademarks are the property of their respective owners.

Fujitsu Components America or its affiliates do not warrant that the content of datasheet is error free. In a continuing effort to improve our products Fujitsu Components America, Inc. or its affiliates reserve the right to change specifications/datasheets without prior notice.
Rev. February 2, 2009.



Компания «ЭлектроПласт» предлагает заключение долгосрочных отношений при поставках импортных электронных компонентов на взаимовыгодных условиях!

Наши преимущества:

- Оперативные поставки широкого спектра электронных компонентов отечественного и импортного производства напрямую от производителей и с крупнейших мировых складов;
- Поставка более 17-ти миллионов наименований электронных компонентов;
- Поставка сложных, дефицитных, либо снятых с производства позиций;
- Оперативные сроки поставки под заказ (от 5 рабочих дней);
- Экспресс доставка в любую точку России;
- Техническая поддержка проекта, помощь в подборе аналогов, поставка прототипов;
- Система менеджмента качества сертифицирована по Международному стандарту ISO 9001;
- Лицензия ФСБ на осуществление работ с использованием сведений, составляющих государственную тайну;
- Поставка специализированных компонентов (Xilinx, Altera, Analog Devices, Intersil, Interpoint, Microsemi, Aeroflex, Peregrine, Syfer, Eurofarad, Texas Instrument, Miteq, Cobham, E2V, MA-COM, Hittite, Mini-Circuits, General Dynamics и др.);

Помимо этого, одним из направлений компании «ЭлектроПласт» является направление «Источники питания». Мы предлагаем Вам помощь Конструкторского отдела:

- Подбор оптимального решения, техническое обоснование при выборе компонента;
- Подбор аналогов;
- Консультации по применению компонента;
- Поставка образцов и прототипов;
- Техническая поддержка проекта;
- Защита от снятия компонента с производства.



Как с нами связаться

Телефон: 8 (812) 309 58 32 (многоканальный)

Факс: 8 (812) 320-02-42

Электронная почта: org@eplast1.ru

Адрес: 198099, г. Санкт-Петербург, ул. Калинина, дом 2, корпус 4, литера А.