

LOC	DIST	REVISIONS					
		P	LTN	DESCRIPTION	DATE	DMN	APVD
ES	00	G5		ADD NEW DASH NUMBER 1-8	11AUG2014	AL	SZ

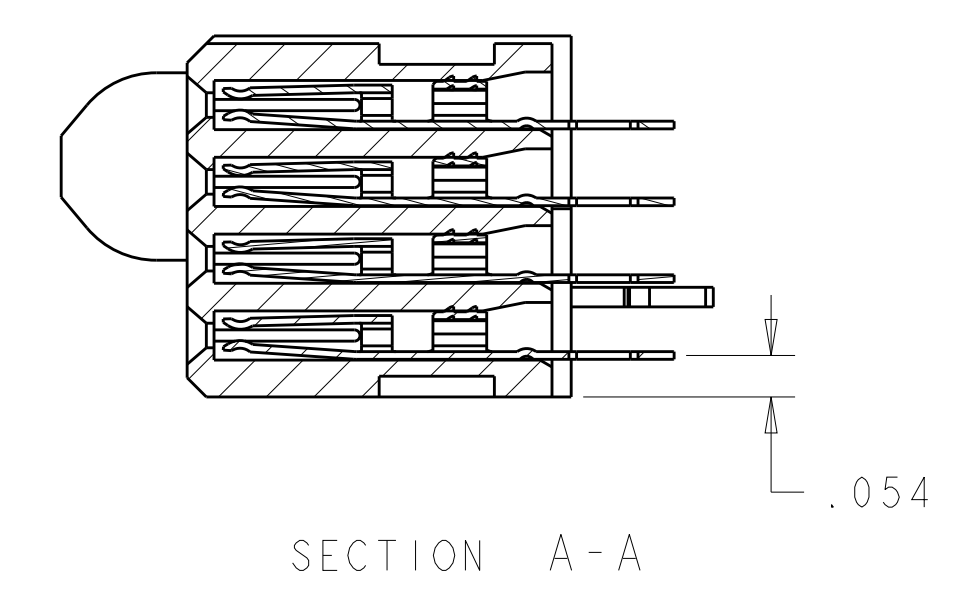
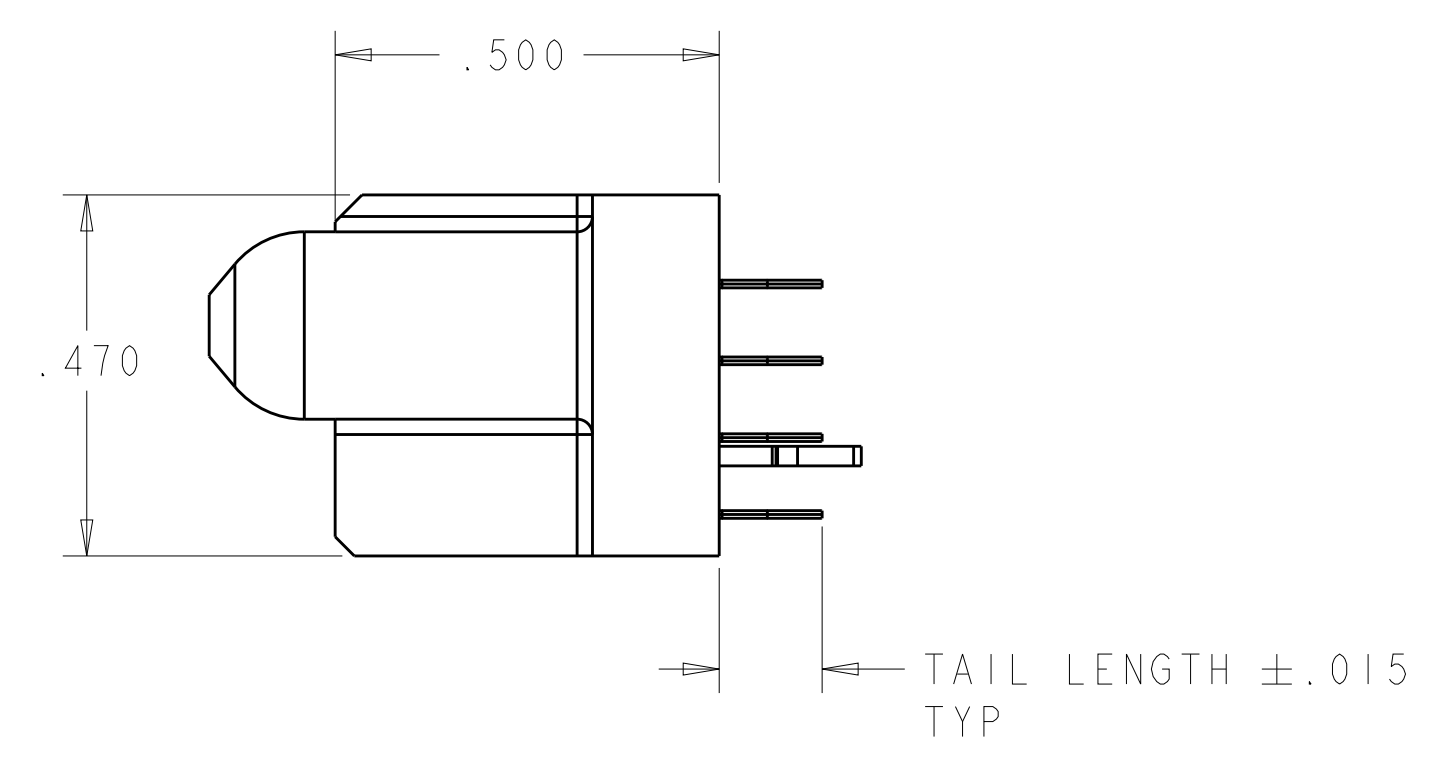
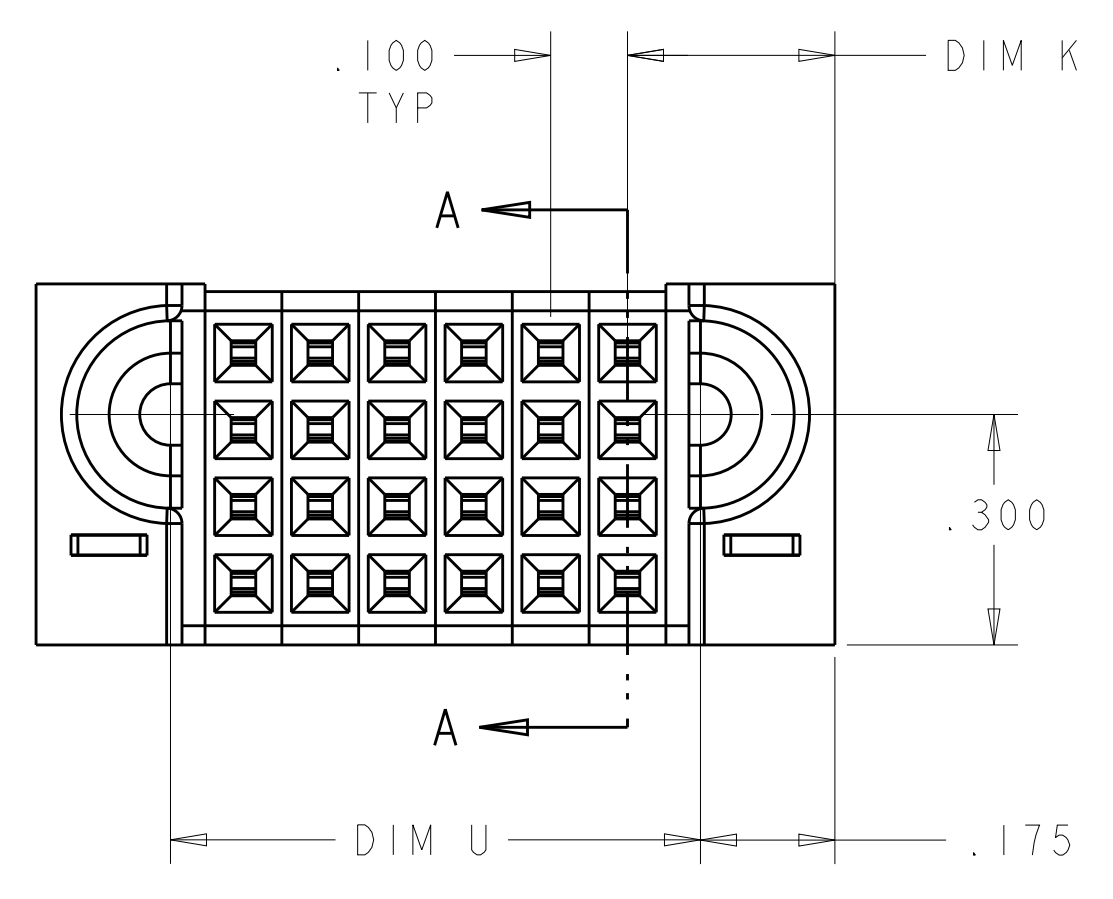
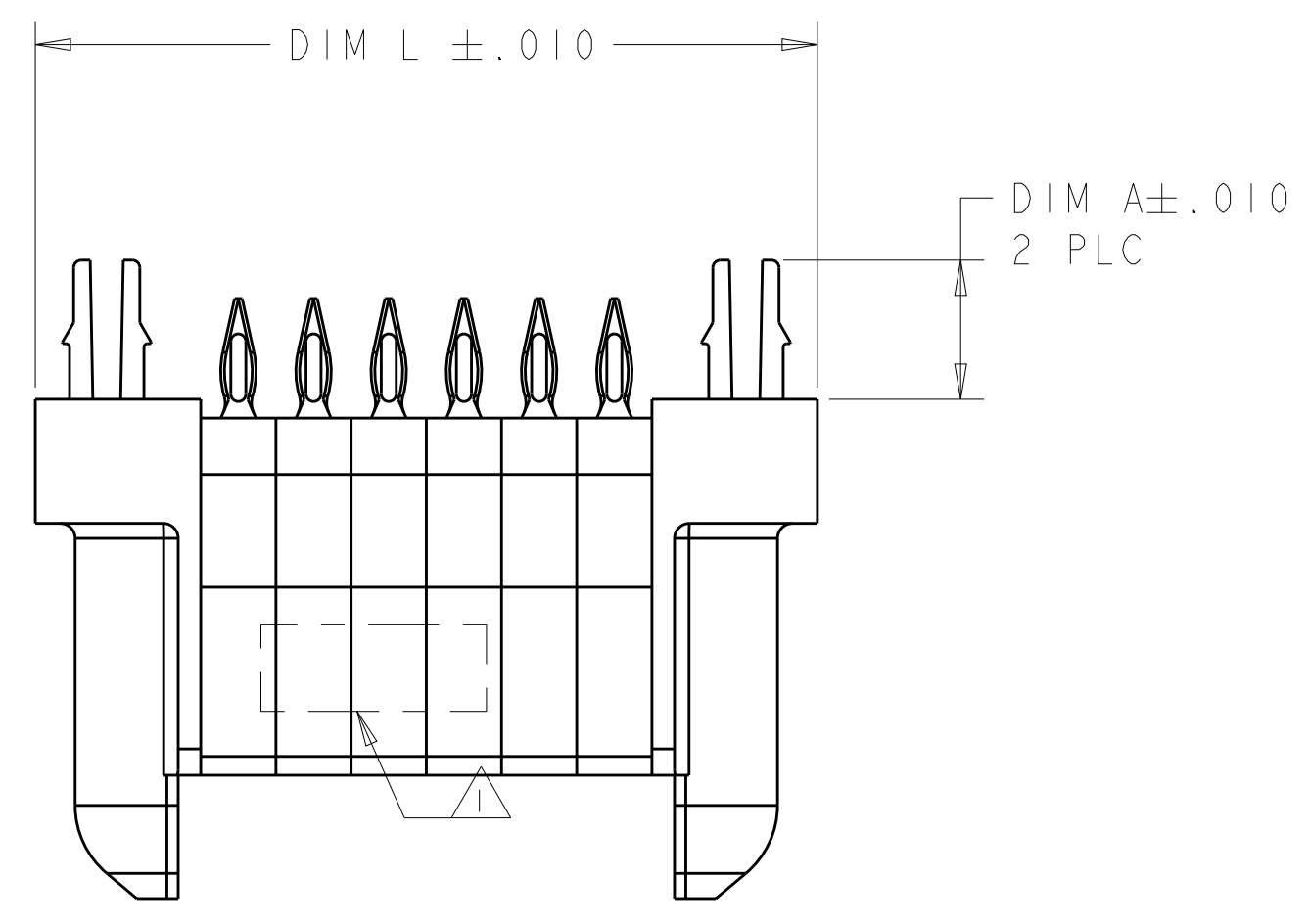
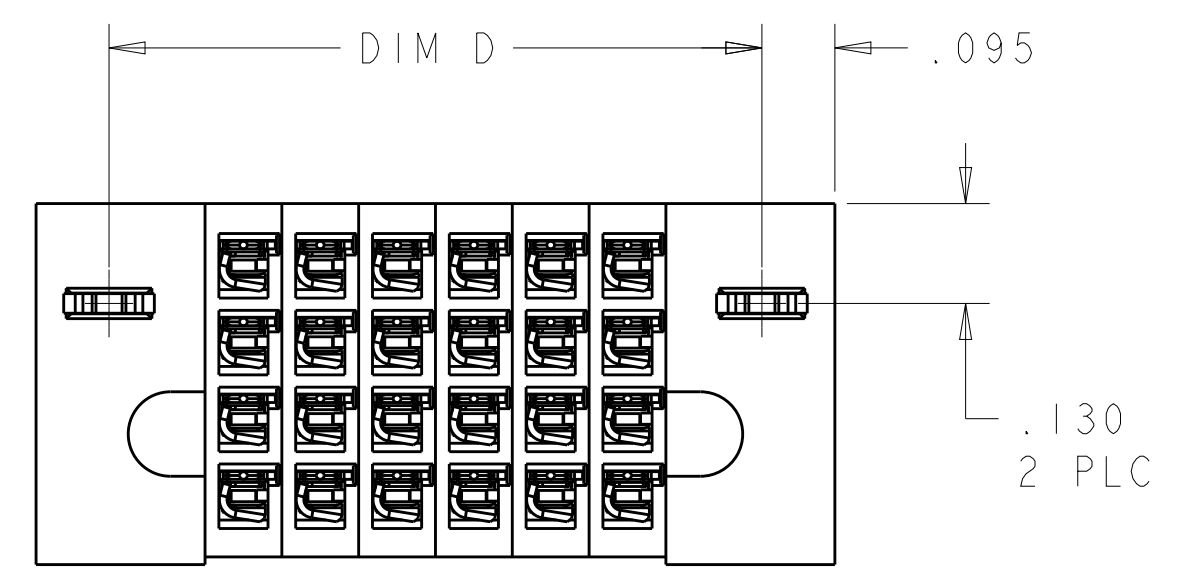

- 1 "AMP", PART NUMBER AND DATE CODE TO BE MARKED IN AREA SHOWN PARTS UNDER 2.00 LONG MAY BE MARKED ON BOTH SIDES
- 2 MATERIAL: HOUSING - GLASS FILLED HIGH TEMP THERMO PLASTIC, UL94 V-0
 SIGNAL CONTACT - HIGH CONDUCTIVITY COPPER ALLOY
 POWER CONTACT - HIGH CONDUCTIVITY COPPER ALLOY
- 3 CONTACT PLATING: NOBLE METAL PLATING ON CONTACT FUNCTIONAL AREA OF POWER AND SIGNAL CONTACTS
- 4 MECHANICAL CONNECTOR KEEP OUT ZONE
- 5 DATUM AND BASIC DIMENSIONS ESTABLISHED BY CUSTOMER
- 6 PCB - ALL HOLE DIAMETERS ARE FINISHED HOLE SIZES
- 7 PCB - 0.0453 ±.0010 DRILLED HOLES PLATED WITH .0003 MIN Sn OVER .001 TO .003 Cu PLATING TO ACHIEVE A .040 ±.0030 HOLE
- 8 FOR "S+P" CONFIGURATION ,VARIABLE DIMENSIONS PLEASE REFER TO SHEET 2
- 9 FOR "S+LP+P" CONFIGURATION ,VARIABLE DIMENSIONS PLEASE REFER TO SHEET 2
- 10 VARIABLE DIMENSION REFER TO THE DIMENSION ON CORRRESPONDING MODEL UNDER THE PCB

THIS DRAWING IS A CONTROLLED DOCUMENT.		DMN C. ZHOU CHK S. ZHAO	20JUN2012 20JUN2012	STE TE Connectivity
DIMENSIONS: INCHES	TOLERANCES UNLESS OTHERWISE SPECIFIED:	APVD	NAME	
	0 PLC ± 1 PLC ± 2 PLC ± 3 PLC ±.005 4 PLC ±.0020 ANGLES ±.7°	PRODUCT SPEC 108-2292	APPLICATION SPEC	VERTICAL RECEPTACLE ASSEMBLY WITH SHORT GUIDE, PRESS FIT MULTI-BEAM XLE
MATERIAL	FINISH	SIZE 114-13251	CAGE CODE A100779	DRAWING NO 6450861
Customer Drawing		WEIGHT	SCALE 1:1	SHEET 1 OF 11
		REV G5		

LOC		DIST		REVISIONS				
ES	00	P	LTH	DESCRIPTION	DATE	DWN	APVD	
		-		SEE SHEET 1				

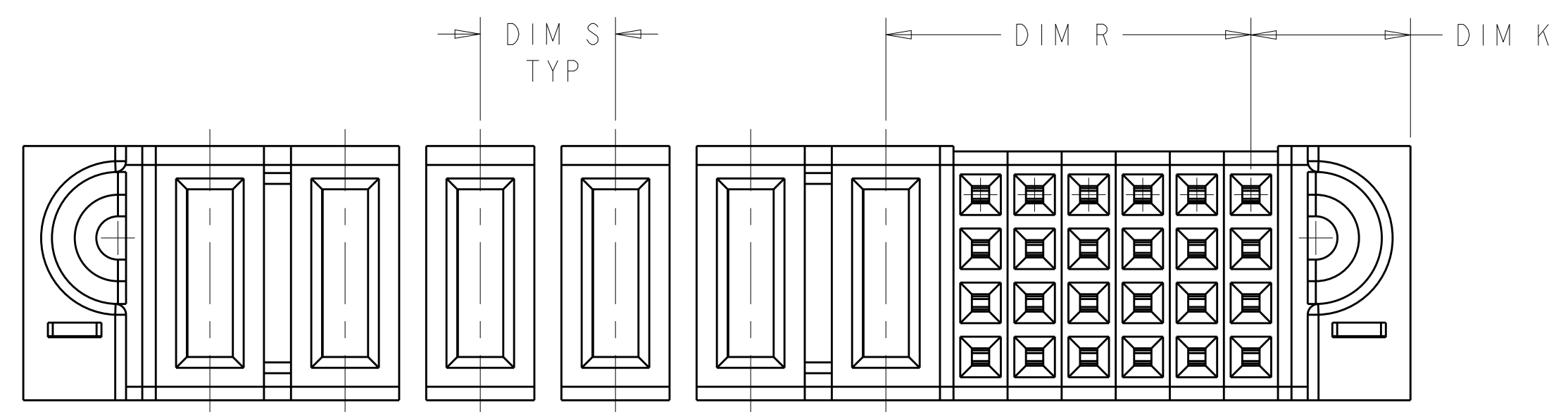

△ FOR "S + P" CONFIGURATION
 UNSPECIFIED DIMENSIONS REFER TO SHEET 1.

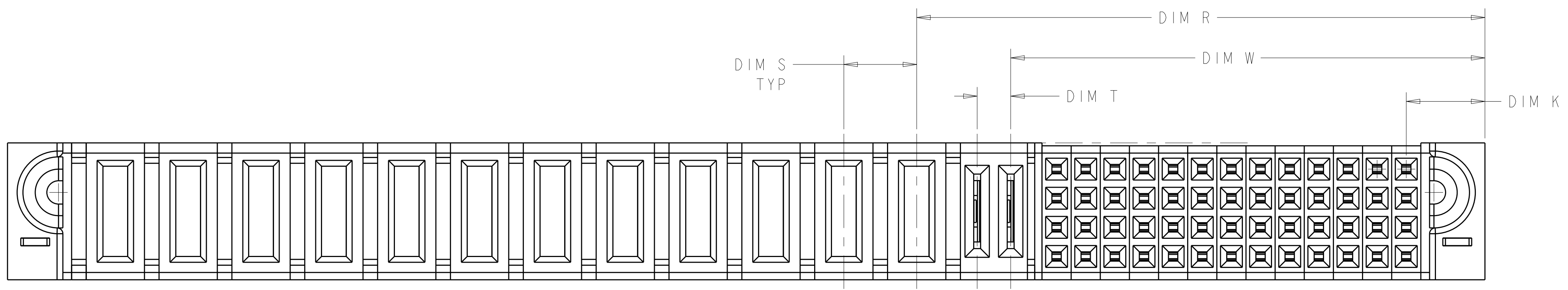

△ FOR "S + LP + P" CONFIGURATION
 UNSPECIFIED DIMENSIONS REFER TO SHEET 1.

65	.185	-	-	-	-	1.640	1.290	1.450	.270	48S	1-6450861-8
	.128	-	-	△	.475 △	1.990	1.640	1.800	.270	16S + 4P	1-6450861-7
	.185	-	-	-	-	.840	.490	.650	.270	16S	1-6450861-6
	.185	-	-	.200 △	.675 △	1.865	1.515	1.675	.270	24S + 4P	1-6450861-5
	.185	-	-	-	-	2.140	1.790	1.950	.320	64S	1-6450861-4
	.185	-	-	.250 △	.475 △	3.840	3.490	3.650	.295	16S + 12P	1-6450861-3
	.185	-	-	.300 △	.875 △	2.465	2.115	2.275	.320	32S + 4ACP	1-6450861-2
	.185	-	-	.250 △	.475 △	3.340	2.990	3.150	.295	16S + 10P	1-6450861-1
	.185	-	-	.250 △	.675 △	2.040	1.690	1.850	.270	24S + 4P	6450861-9
	.185	-	-	.250 △	.475 △	1.440	1.090	1.250	.320	16S + 2P	6450861-8
	.185	.115 △	1.6275 △	.250 △	1.950 △	5.070	4.720	4.880	.270	52S + 2LP + 12P	6450861-6
	.185	-	-	.250 △	.675 △	3.065	2.715	2.875	.295	24S + 8P	6450861-5
	.185	-	-	.250 △	.675 △	2.565	2.215	2.375	.295	24S + 6P	6450861-4
	.185	-	-	.250 △	.675 △	2.565	2.215	2.375	.295	24S + 6P	6450861-3
	.185	-	-	-	-	2.240	1.890	2.050	.270	72S	6450861-2
	.185	-	-	-	-	1.040	.690	.850	.270	24S	6450861-1
	DIM A	DIM T	DIM W	DIM S	DIM R	DIM L	DIM U	DIM D	DIM K	DESCRIPTION	PART NUMBER

THIS DRAWING IS A CONTROLLED DOCUMENT.

DIMENSIONS: INCHES

TOLERANCES UNLESS OTHERWISE SPECIFIED:

0 PLC	±
1 PLC	±.01
2 PLC	±.005
3 PLC	±.002
4 PLC	±.001
ANGLES	±.002

MATERIAL: - FINISH: -

DATE: 11/14/2008

SCALE: 4:1 SHEET 2 OF 11 REV 66

CUSTOMER DRAWING

STE TE Connectivity

VERVE BARBERSCOMB ASSEMBLY WITH ISH FOR GOLD PLATE, PRESS FIT MULTI-MATERIAL XLE

108-2292 APPLICATION SPEC

114-13058 WEIGHT

A100779 C=6450861

LOC	DIST	REVISIONS			
P	LTN	DESCRIPTION	DATE	DMN	APVD
ES	00	SEE SHEET 1			

PART NUMBER	ROWS	POWER						SIGNAL							
		P6	P5	P4	P3	P2	P1	6	5	4	3	2	1		
6450861-3	D C B A	GS	GS	GS	GS	GS	GS	AP	AP	AP	AP	AP	AP	HD	HD
								AP	AP	AP	AP	AP	AP		
								AP	AP	AP	AP	AP	AP		
24S + 6P															

PART NUMBER	ROWS	SIGNAL						
		6	5	4	3	2	1	
6450861-1	D C B A	AP	AP	AP	AP	AP	AP	HD
		AP	AP	AP	AP	AP	AP	
		AP	AP	AP	AP	AP	AP	
24S								

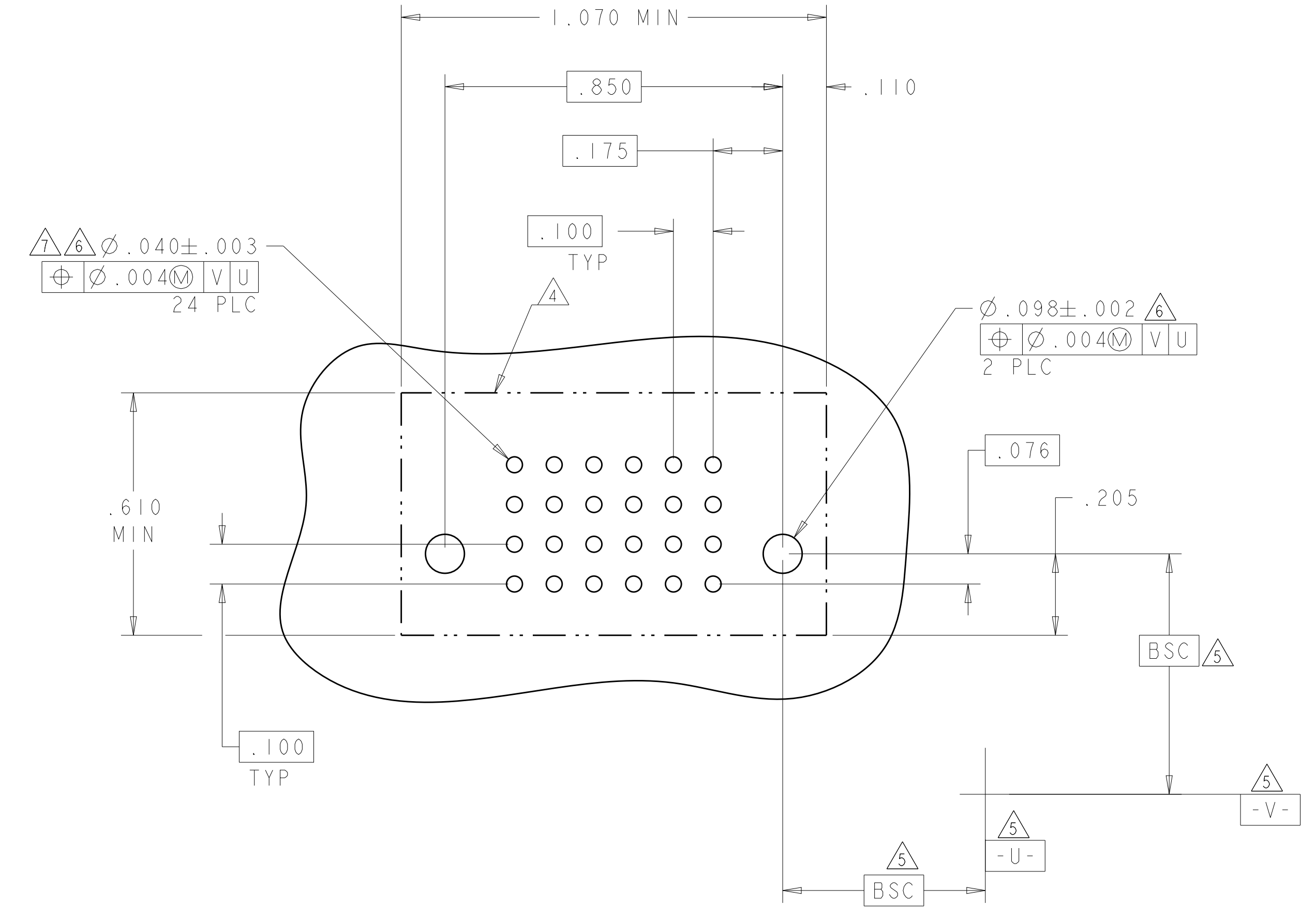
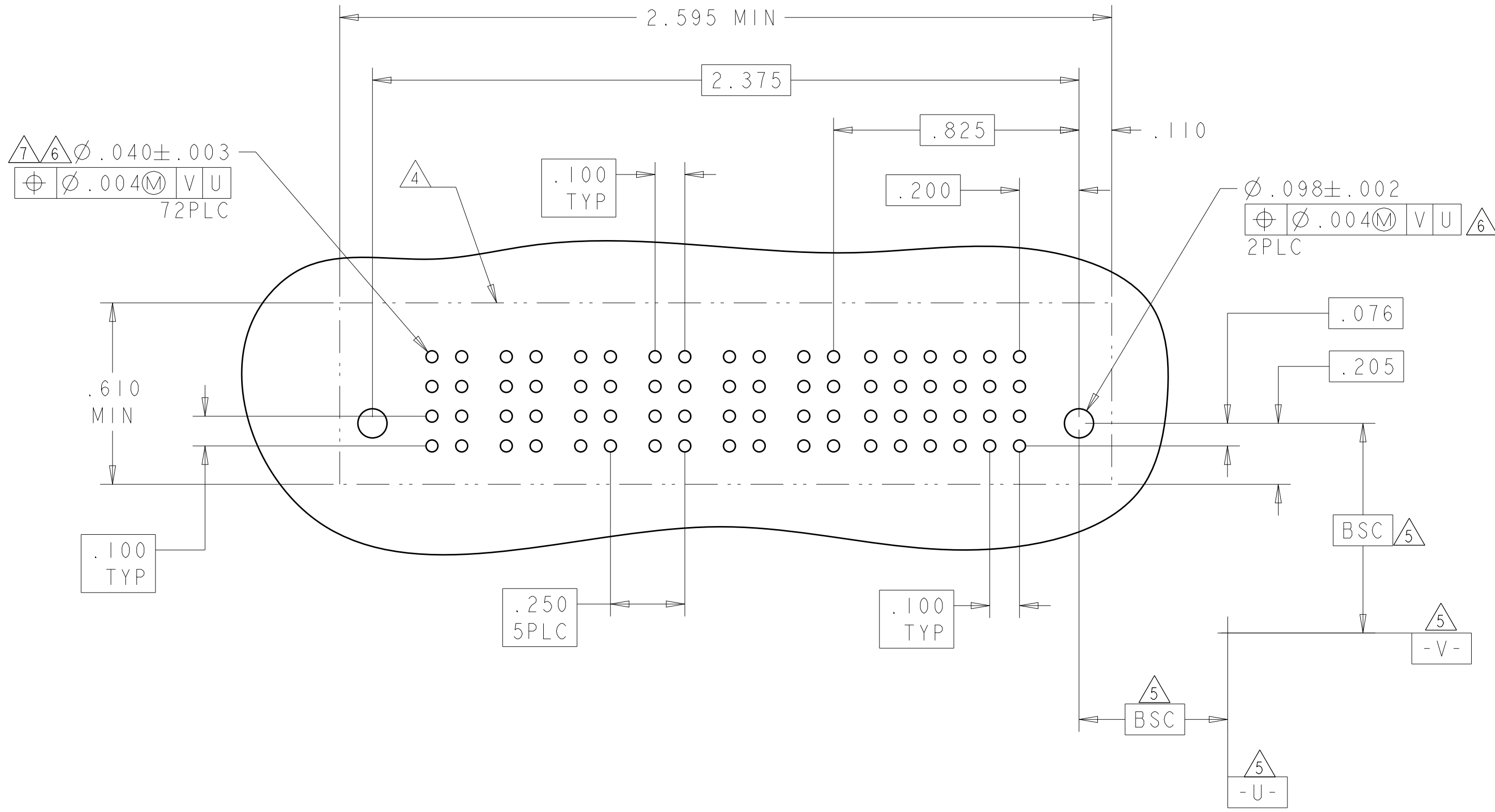

CODE	CONTACT TABLE
HS	STD POWER PRESS FIT CONTACT .165"
BP	SIGNAL PRESS FIT CONTACT .165"
AP	SIGNAL PRESS FIT CONTACT .135"
GP	MFBL POWER PRESS FIT CONTACT .135"
GS	STD POWER PRESS FIT CONTACT .135"
TAIL LENGTH	

THIS DRAWING IS A CONTROLLED DOCUMENT. DWG: C.ZHOU 08MAR2008
 CHK: S.ZHAO 08MAR2008
 APVD: S.YAO

STE TE Connectivity

VERVE GABE REPER S&CMB ASSEMBLY
 W/ WITH HS FOR TO LOUDEDSE, PRESSURE FIT
 MULTI-MATERIAL RELEASEM XLE

PRODUCT SPEC: 108-2292
 APPLICATION SPEC: 114-1305B
 WEIGHT: -
 MATERIAL: -
 FINISH: -

SCALE: 4:1 SHEET 3 OF 11 REV: G5

LOC	DIST	REVISIONS					
ES	00	P	LTN	DESCRIPTION	DATE	DWN	APVD
		-		SEE SHEET 1			

PART NUMBER	ROWS	SIGNAL																	
		18	17	16	15	14	13	12	11	10	9	8	7	6	5	4	3	2	1
6450861-2	D C B A	AP	AP	AP	AP	AP	AP	AP	AP	AP	AP	AP	AP	AP	AP	AP	AP	AP	AP
		AP	AP	AP	AP	AP	AP	AP	AP	AP	AP	AP	AP	AP	AP	AP	AP	AP	AP
		AP	AP	AP	AP	AP	AP	AP	AP	AP	AP	AP	AP	AP	AP	AP	AP	AP	AP
		AP	AP	AP	AP	AP	AP	AP	AP	AP	AP	AP	AP	AP	AP	AP	AP	AP	AP
72S																			

PART NUMBER	ROWS	POWER						SIGNAL					
		P6	P5	P4	P3	P2	P1	6	5	4	3	2	1
6450861-4	D C B A	GS	GS	GS	GS	GS	GS	AP	AP	AP	AP	AP	AP
		GS	GS	GS	GS	GS	GS	AP	AP	AP	AP	AP	AP
		GS	GS	GS	GS	GS	GS	AP	AP	AP	AP	AP	AP
		GS	GS	GS	GS	GS	GS	AP	AP	AP	AP	AP	AP
24S + 6P													

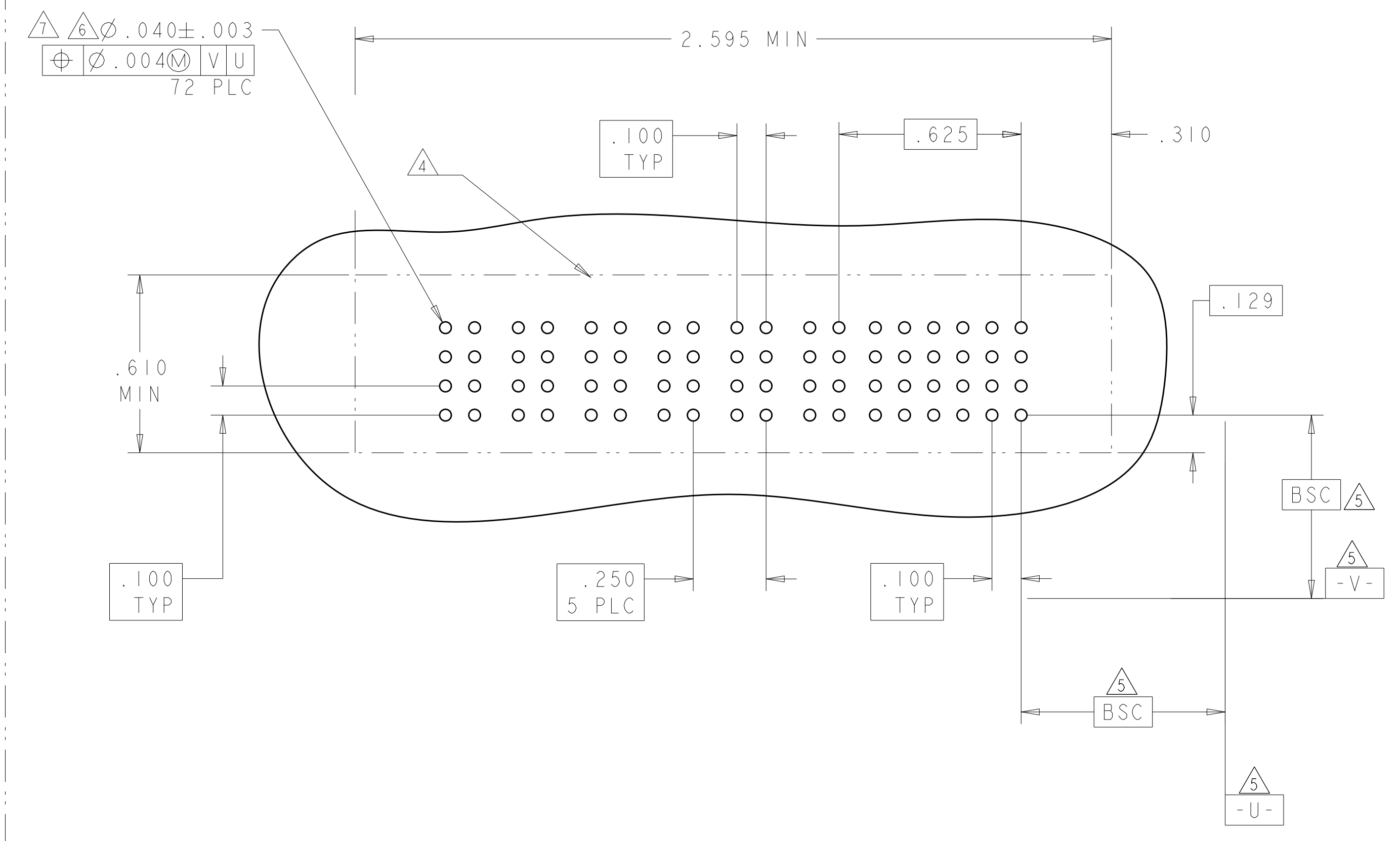
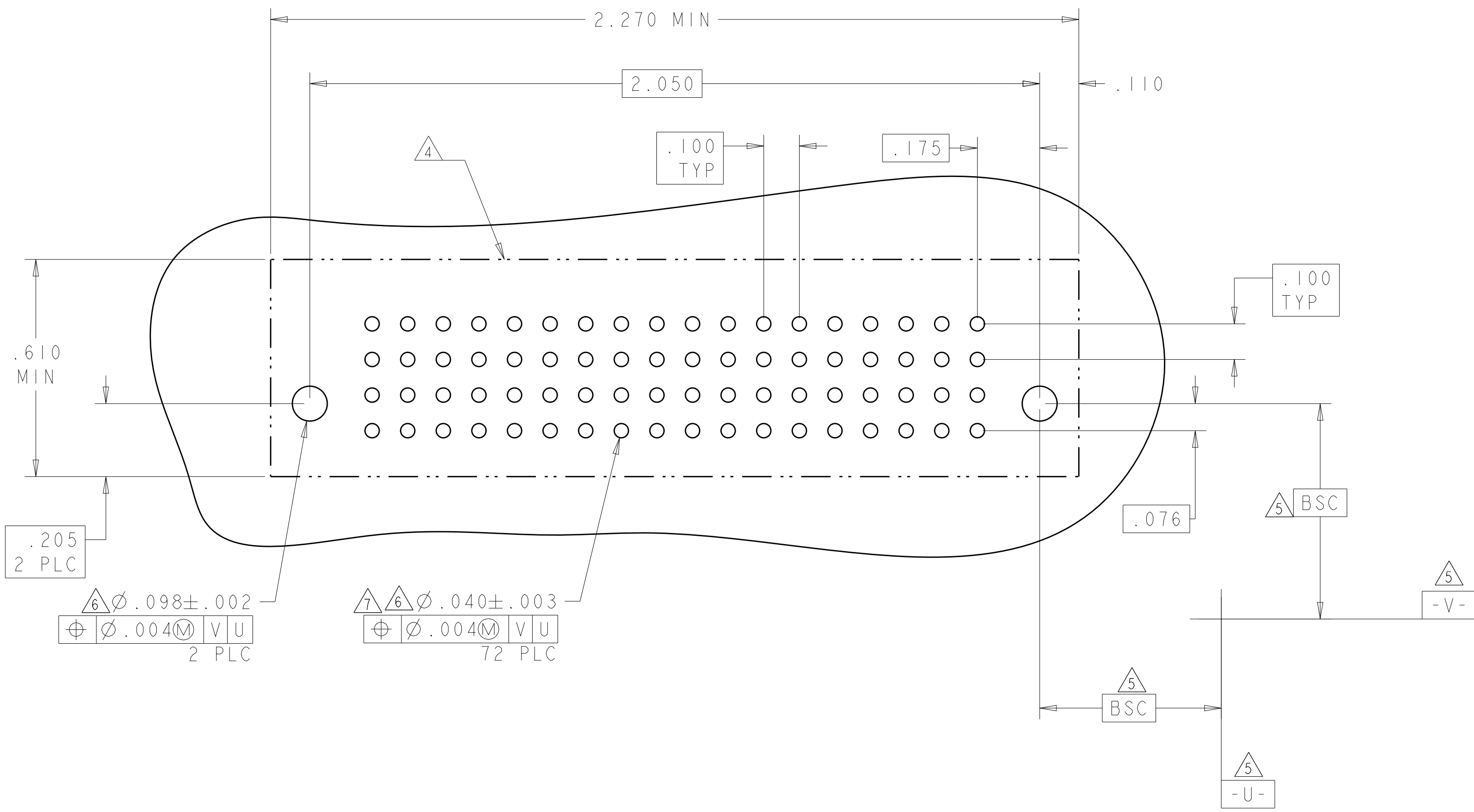

THIS DRAWING IS A CONTROLLED DOCUMENT.		DWN C. ZHOU	80602008	STE TE Connectivity
DIMENSIONS: INCHES		CHK S. ZHAO	80602008	
TOLERANCES UNLESS OTHERWISE SPECIFIED:		NAME S. YAO		VERVE GABE REVERSE SMT ASSEMBLY W/ WITH ISH FOR TO GOLDEN, PRESSURE FIT MULTI-MATERIAL - XLE
0 PLC ± .01 1 PLC ± .01 2 PLC ± .01 3 PLC ± .005 4 PLC ± .002 ANGLES ± 2°		PRODUCT SPEC 108-2292		
MATERIAL		APPLICATION SPEC 114-13058		SIZE A1
FINISH		WEIGHT		CAGE CODE 100779
		CUSTOMER DRAWING		SCALE 4:1
				SHEET 4
				OF 11
				REV 66

LOC	DIST	REVISIONS			
P	LTN	DESCRIPTION	DATE	DWN	APVD
-	-	SEE SHEET 1	-	-	-

PART NUMBER	ROWS	POWER								SIGNAL					
		P8	P7	P6	P5	P4	P3	P2	P1	6	5	4	3	2	1
6450861-5	D C B A	GS	GS	GS	GS	GS	GS	GS	GS	AP	AP	AP	AP	AP	AP
		GS	GS	GS	GS	GS	GS	GS	GS	AP	AP	AP	AP	AP	AP
		GS	GS	GS	GS	GS	GS	GS	GS	AP	AP	AP	AP	AP	AP
24S + 8P															

PART NUMBER	ROWS	POWER												SIGNAL																		
		P12	P11	P10	P9	P8	P7	P6	P5	P4	P3	P2	P1	LP2	LPI	13	12	11	10	9	8	7	6	5	4	3	2	1				
6450861-6	D C B A	GS	GS	GS	GS	GS	GS	GS	GS	GS	GS	GS	GS	GS	LSI	LSI	AP	AP	AP	AP	AP	AP	AP	AP	AP	AP	AP	AP	AP	AP	AP	AP
		GS	GS	GS	GS	GS	GS	GS	GS	GS	GS	GS	GS	GS	LSI	LSI	AP	AP	AP	AP	AP	AP	AP	AP	AP	AP	AP	AP	AP	AP	AP	AP
		GS	GS	GS	GS	GS	GS	GS	GS	GS	GS	GS	GS	GS	LSI	LSI	AP	AP	AP	AP	AP	AP	AP	AP	AP	AP	AP	AP	AP	AP	AP	AP
52S + 2LP + 12P																																

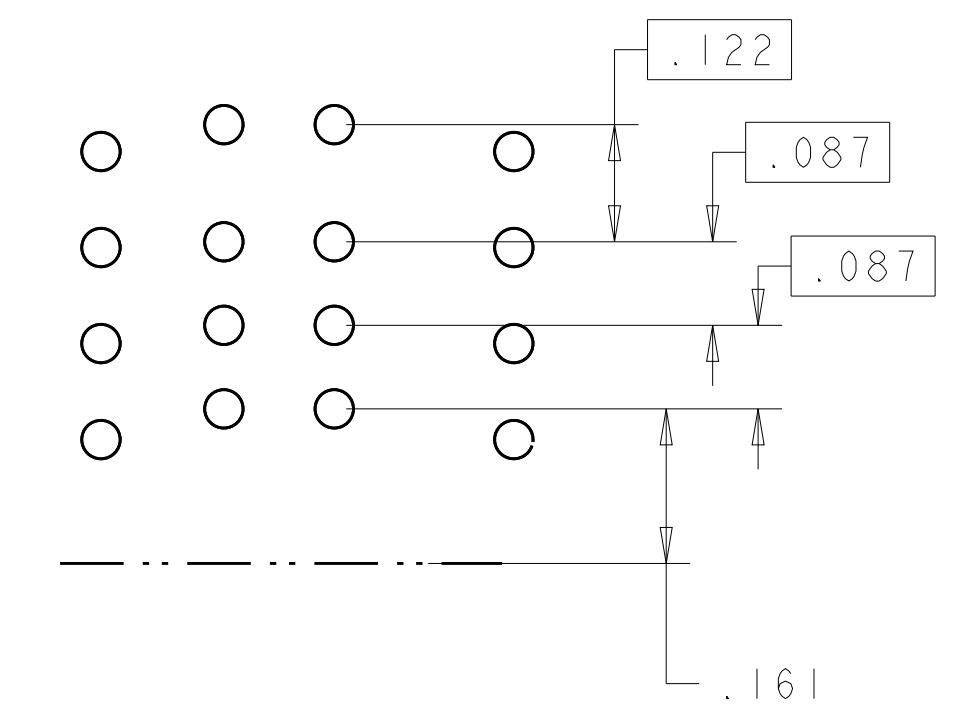
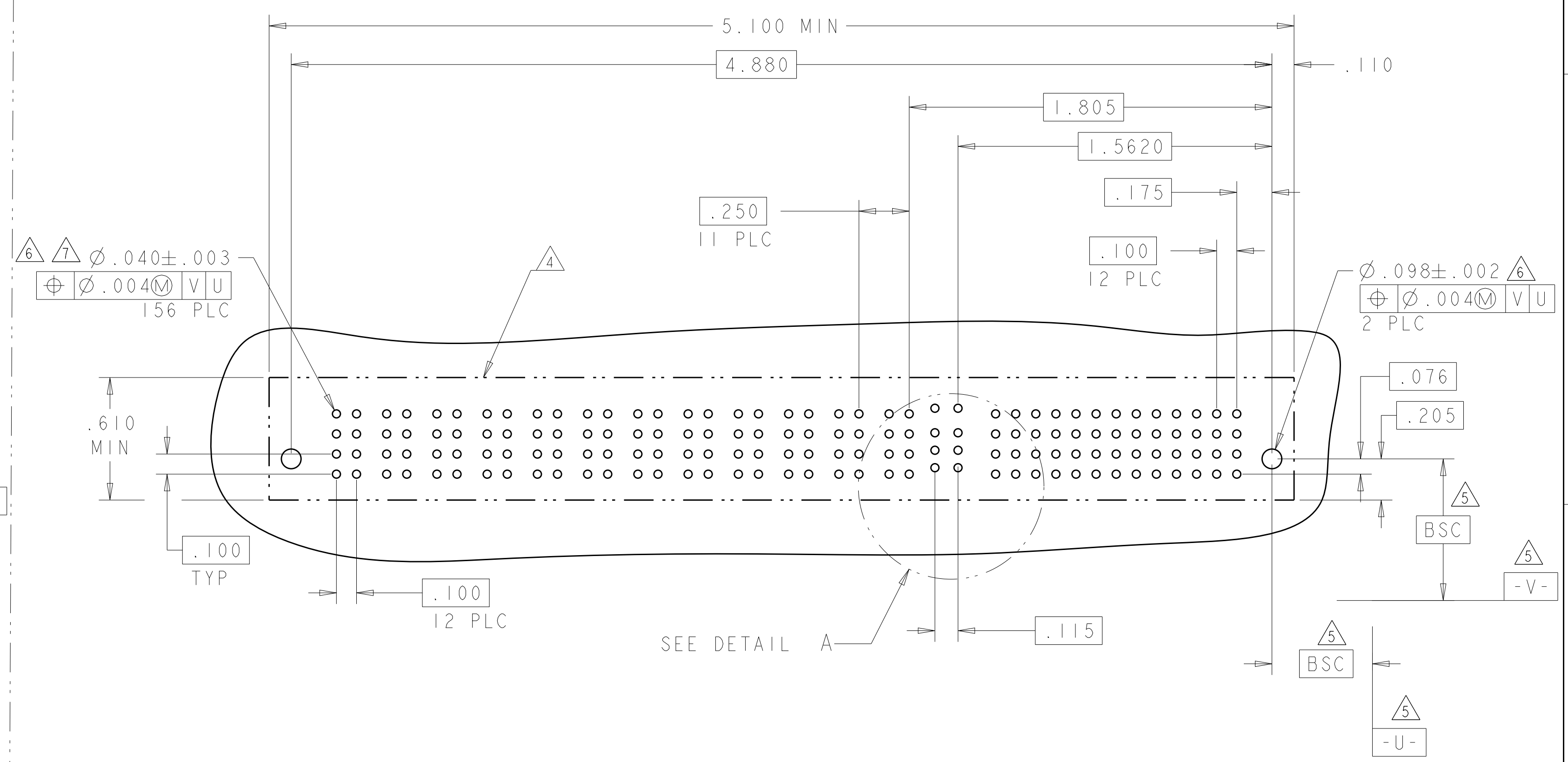
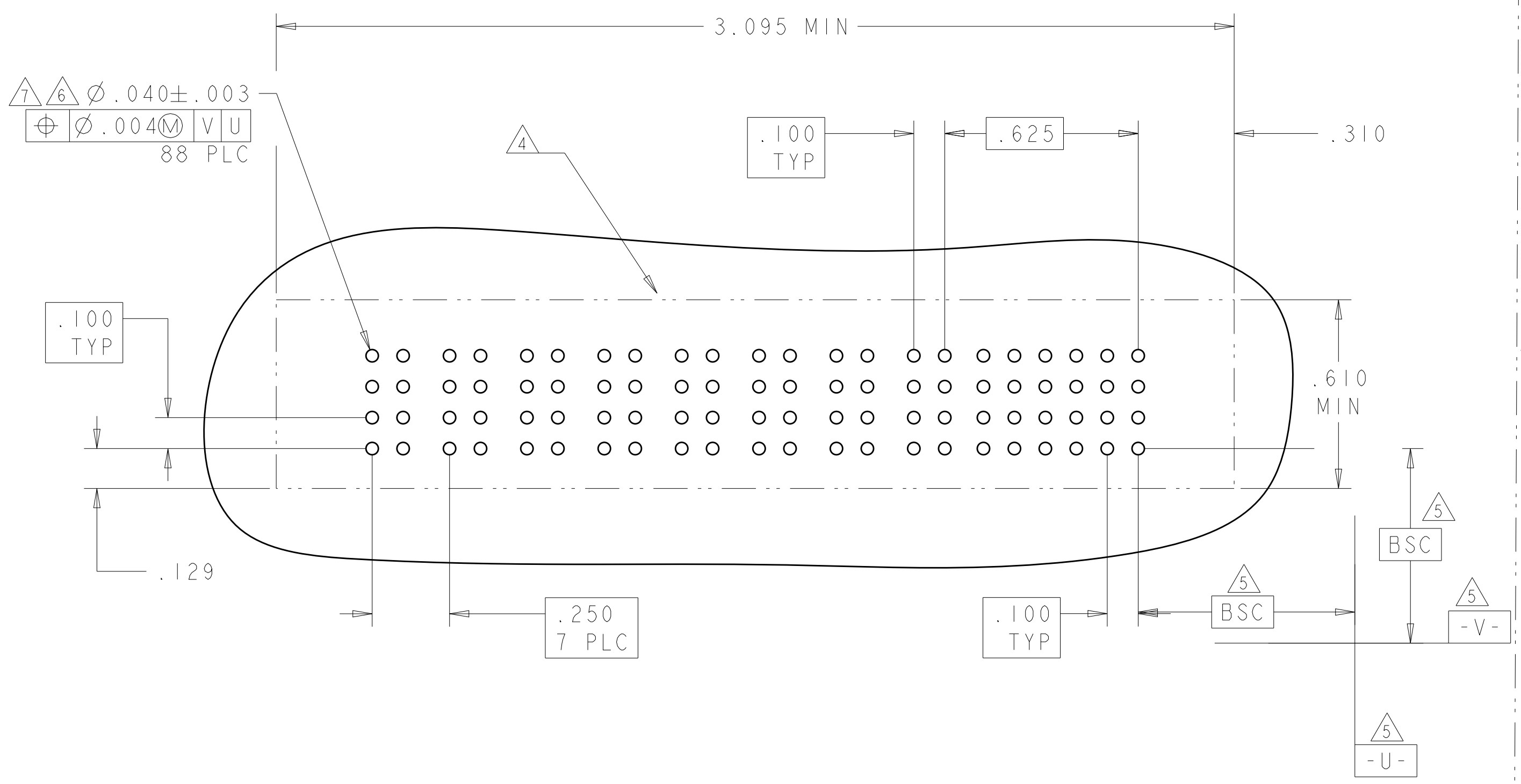

DETAIL A
SCALE 5:1

THIS DRAWING IS A CONTROLLED DOCUMENT.		DWN C. ZHOU	88MNR2008		TE Connectivity	
DIMENSIONS: INCHES		CHK S. ZHAO	88MNR2008		NAME VERVIEWER REVERSE S&C M&S ASSEMBLY WITH 150 FOR TO GOLD LEADS, PRESSURE FIT MULTI-MATERIAL RELEAM XLE	
TOLERANCES UNLESS OTHERWISE SPECIFIED:		APVD S. YAO		PRODUCT SPEC		
0 PLC ±.01		PRODUCT SPEC		108-2292		
1 PLC ±.01		APPLICATION SPEC		114-13058		
2 PLC ±.005		SIZE		A100779		
3 PLC ±.002		CAGE CODE		C=6450861		
4 PLC ±.0020		DRAWING NO		SCALE 4:1		
ANGLES ±.2°		WEIGHT		SHEET 5 OF 11		
FINISH		CUSTOMER DRAWING		REV 66		

LOC		DIST		REVISIONS			
ES	00	P	LTH	DESCRIPTION	DATE	DWN	APVD
				SEE SHEET 1			

PART NUMBER	ROWS	POWER		SIGNAL				HD	HD
		P2	PI	4	3	2	1		
6450861-8	D C B A	GS	GS	AP	AP	AP	AP	HD	HD
				AP	AP	AP	AP		
				AP	AP	AP	AP		
				AP	AP	AP	AP		
16S + 2P									

PART NUMBER	ROWS	POWER				SIGNAL					HD	HD			
		P4	P3	P2	PI	6	5	4	3	2			1		
6450861-9	D C B A	GP	GP	GP	GP	AP	AP	AP	AP	AP	AP	AP	AP	HD	HD
						AP	AP	AP	AP	AP	AP	AP			
						AP	AP	AP	AP	AP	AP	AP			
						AP	AP	AP	AP	AP	AP	AP			
24S + 4P															

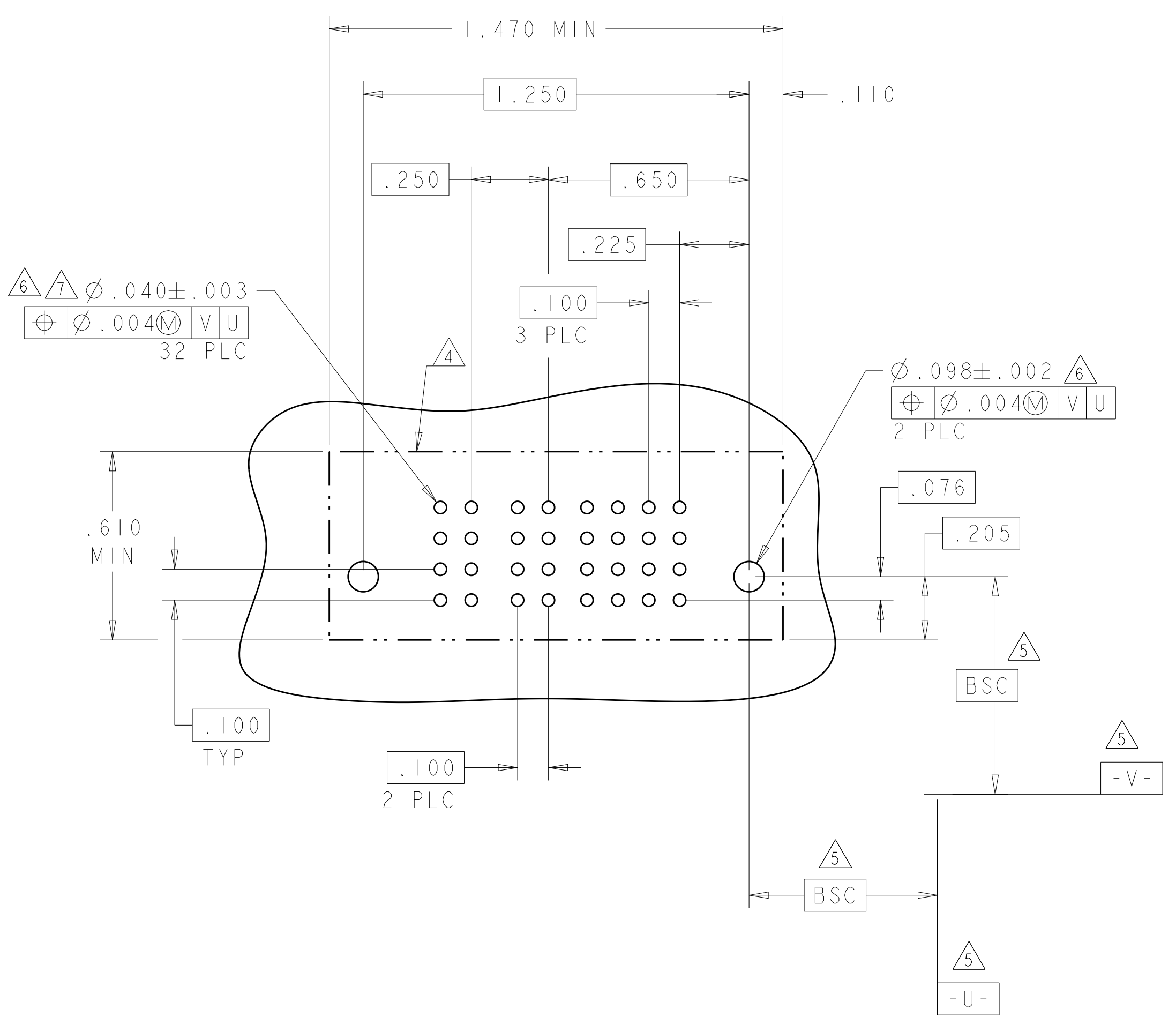

(F)

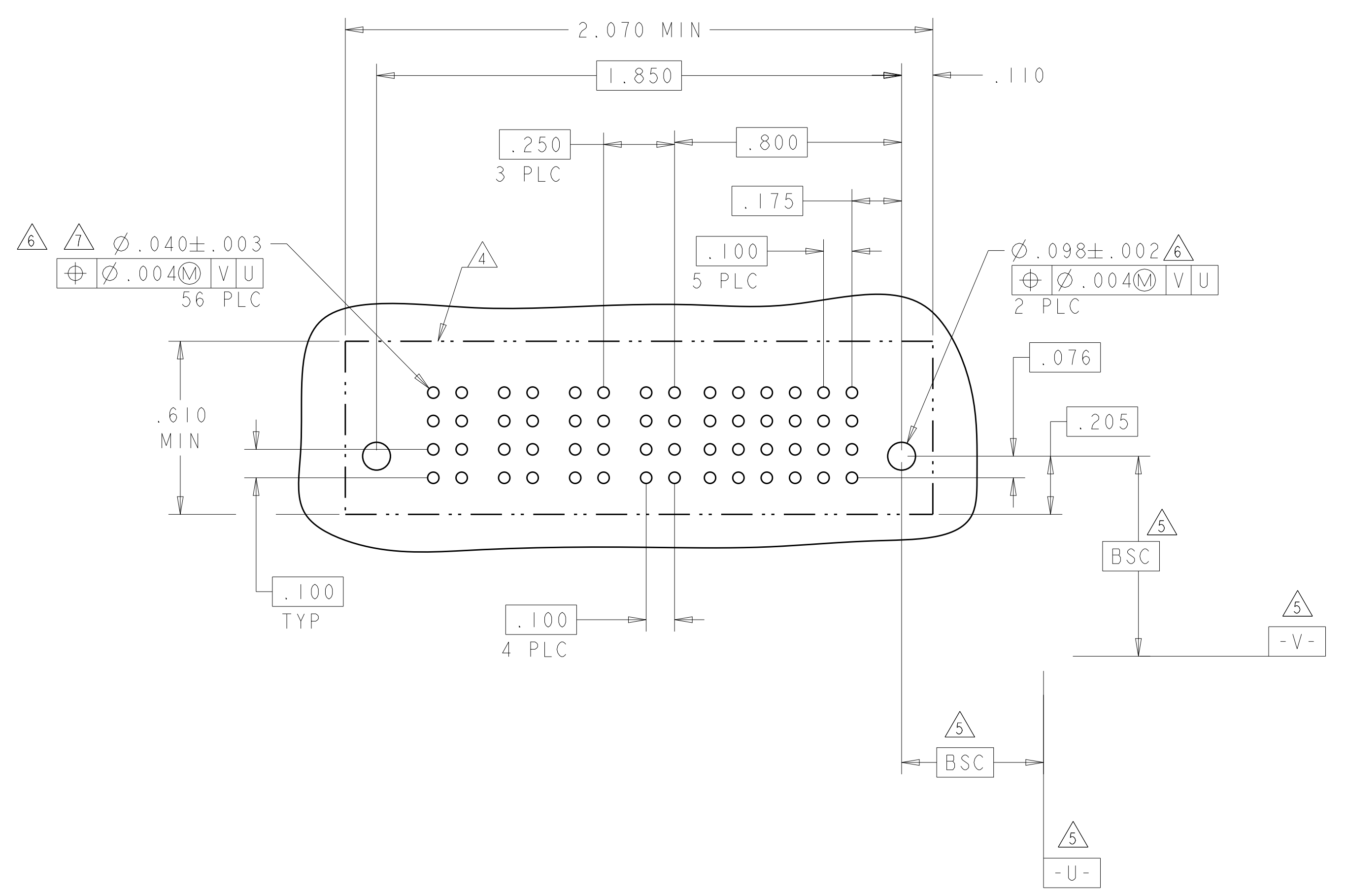

THIS DRAWING IS A CONTROLLED DOCUMENT.		DWN: C.ZHOU	808082008		TE Connectivity
DIMENSIONS: INCHES		CHK: S.ZHAO	808082008		NAME: VERVIEWBAREBERSSEMBASSEMBLY
TOLERANCES UNLESS OTHERWISE SPECIFIED:		APVD: S.YAO		PRODUCT SPEC: 108-2292	
0 PLC ±.01				APPLICATION SPEC: 114-13058	
1 PLC ±.01				SIZE: A1	
2 PLC ±.01				CAGE CODE: 6450861	
3 PLC ±.005				DRAWING NO: 114-13058	
4 PLC ±.002				WEIGHT: -	
ANGLES ±.2°				CUSTOMER DRAWING	
FINISH: -				SCALE: 4:1	
				SHEET 6 OF 11	
				REV 66	

LOC	DIST	REVISIONS			
P	LTN	DESCRIPTION	DATE	DMN	APVD
ES	00	SEE SHEET 1			

PART NUMBER	ROWS	POWER										SIGNAL			
		P10	P9	P8	P7	P6	P5	P4	P3	P2	P1	4	3	2	1
I-6450861-1	D C B A	GS	GS	GS	GS	GS	GS	GS	GS	GS	GS	AP	AP	AP	AP
		GS	GS	GS	GS	GS	GS	GS	GS	GS	GS	AP	AP	AP	AP
		GS	GS	GS	GS	GS	GS	GS	GS	GS	GS	AP	AP	AP	AP
		GS	GS	GS	GS	GS	GS	GS	GS	GS	GS	AP	AP	AP	AP
16S + 10P															

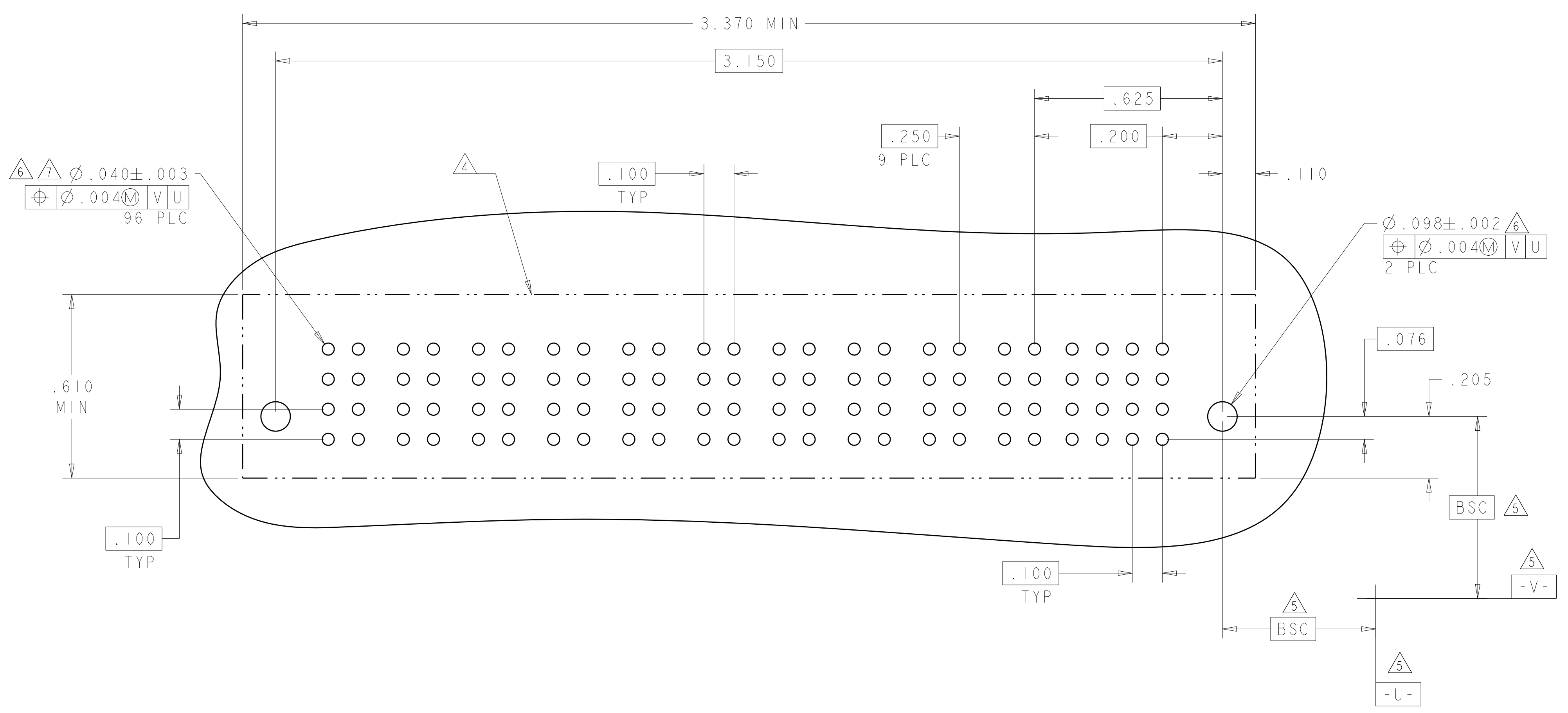

THIS DRAWING IS A CONTROLLED DOCUMENT.		DMN C. ZHOU	88MNR2008		TE Connectivity	
DIMENSIONS: INCHES		CHK S. ZHAO	88MNR2008		NAME VERVIEWBAREBERSSEMBLY	
TOLERANCES UNLESS OTHERWISE SPECIFIED:		APVD S. YAO		PRODUCT SPEC 108-2292		
0 PLC ±.01				APPLICATION SPEC		
1 PLC ±.01				114-13058		
2 PLC ±.01				WEIGHT		
3 PLC ±.005				A100779C=6450861		
4 PLC ±.002				SCALE 4:1 SHEET 7 OF 11 REV 66		
ANGLES ±.2°				CUSTOMER DRAWING		
FINISH						

LOC	DIST	REV	DATE	BY	APPV
ES	00				
DESCRIPTION			DATE	BY	APPV
SEE SHEET 1					

PART NUMBER	ROWS	POWER				SIGNAL								
		P4	P3	P2	P1	8	7	6	5	4	3	2	1	
1-6450861-2	D C B A	GP	GP	GP	GP	AP	AP	AP	AP	AP	AP	AP	AP	AP
		GP	GP	GP	GP	AP	AP	AP	AP	AP	AP	AP	AP	
		GP	GP	GP	GP	AP	AP	AP	AP	AP	AP	AP	AP	
		GP	GP	GP	GP	AP	AP	AP	AP	AP	AP	AP	AP	
32S + 4ACP														

PART NUMBER	ROWS	POWER												SIGNAL			
		P12	P11	P10	P9	P8	P7	P6	P5	P4	P3	P2	P1	4	3	2	1
1-6450861-3	D C B A	GS	GS	GS	GS	GS	GS	GS	GS	GS	GS	GS	GS	GS	GS	GS	GS
		GS	GS	GS	GS	GS	GS	GS	GS	GS	GS	GS	GS	GS	GS	GS	GS
		GS	GS	GS	GS	GS	GS	GS	GS	GS	GS	GS	GS	GS	GS	GS	GS
		GS	GS	GS	GS	GS	GS	GS	GS	GS	GS	GS	GS	GS	GS	GS	GS
16S + 12P																	

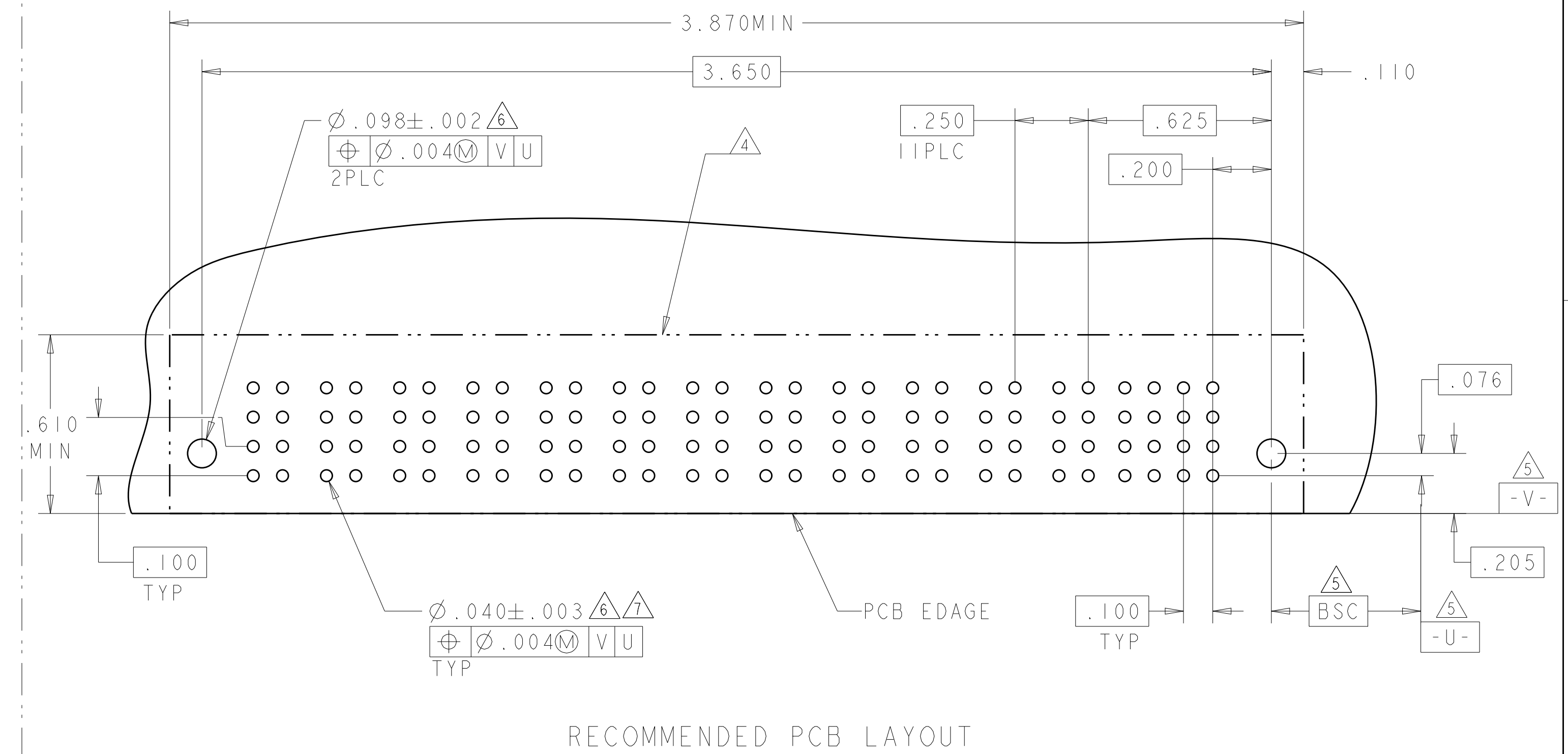
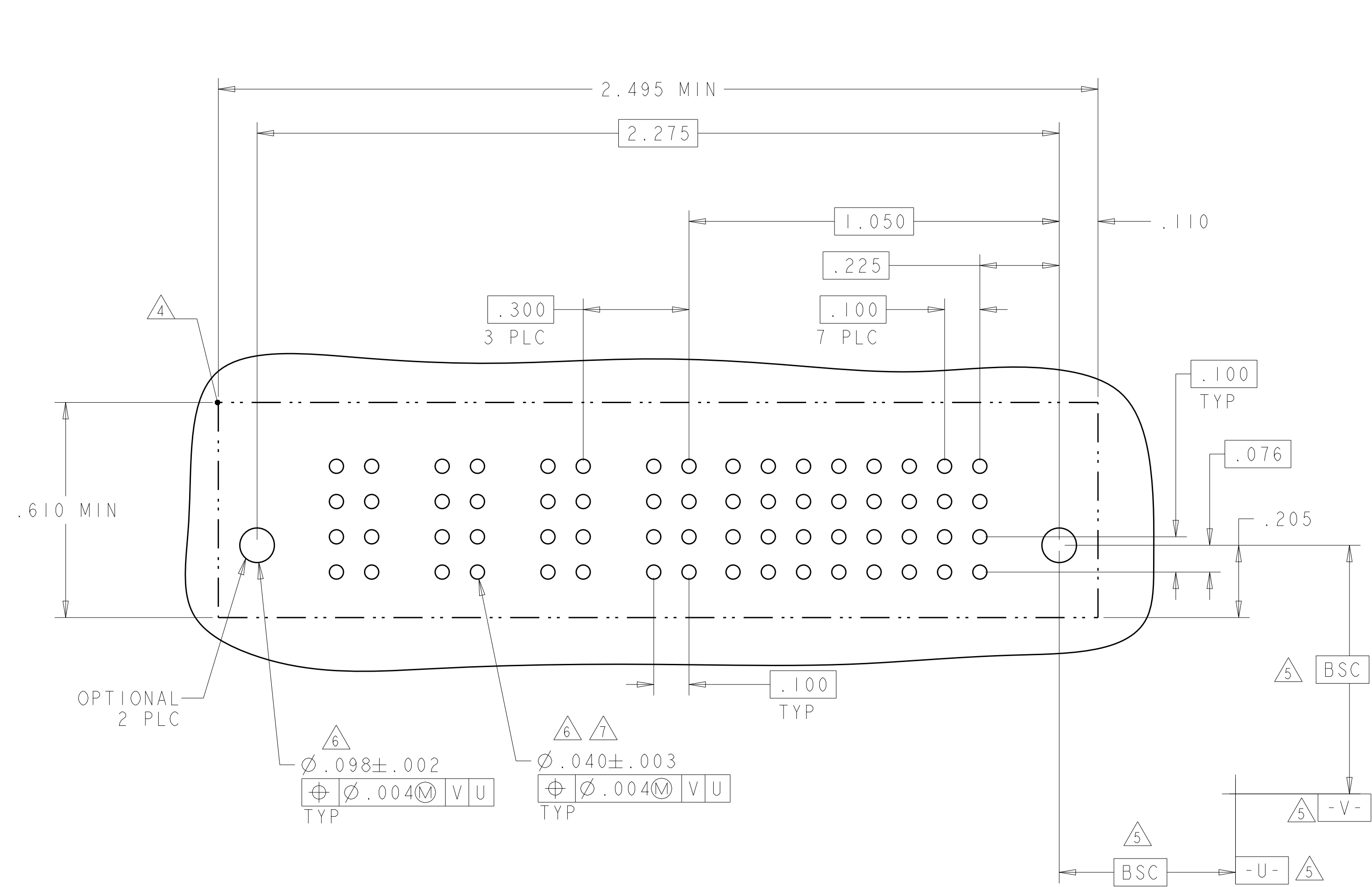

THIS DRAWING IS A CONTROLLED DOCUMENT.		OWN C. ZHOU CHK S. ZHAO	20JUN2012 20JUN2012	 TE Connectivity
DIMENSIONS: INCHES	TOLERANCES UNLESS OTHERWISE SPECIFIED:	APVD	NAME	
0 PLC ±. 1 PLC ±. 2 PLC ±. 3 PLC ±.005 4 PLC ±.0020 ANGLES ±.2°	PRODUCT SPEC 108-2292 APPLICATION SPEC 114-13251 WEIGHT SCALE 1:1	SHEET 8 OF 11 REV G5	VERTICAL RECEPTACLE ASSEMBLY WITH SHORT GUIDE, PRESS FIT MULTI-BEAM XLE A100779C=6450861	
MATERIAL	FINISH	Customer Drawing	RESTRICTED TO	

LOC		DIST		REVISIONS			
ES	00	P	LTN	DESCRIPTION	DATE	DWN	APVD
		-		SEE SHEET 1			

F6

PART NUMBER	ROWS	SIGNAL															
		16	15	14	13	12	11	10	9	8	7	6	5	4	3	2	1
1-6450861-4	D	BP	BP	BP	BP	BP	BP	BP	BP	BP	BP	BP	BP	BP	BP	BP	BP
	C	BP	BP	BP	BP	BP	BP	BP	BP	BP	BP	BP	BP	BP	BP	BP	BP
	B	BP	BP	BP	BP	BP	BP	BP	BP	BP	BP	BP	BP	BP	BP	BP	BP
	A	BP	BP	BP	BP	BP	BP	BP	BP	BP	BP	BP	BP	BP	BP	BP	BP
64S		HD															HD

PART NUMBER	ROWS	POWER				SIGNAL					
		P4	P3	P2	P1	6	5	4	3	2	1
1-6450861-5	D					AP	AP	AP	AP	AP	AP
	C					AP	AP	AP	AP	AP	AP
	B	GS	GS	GS	GS	AP	AP	AP	AP	AP	AP
	A	HD				AP	AP	AP	AP	AP	AP
24S + 4P											

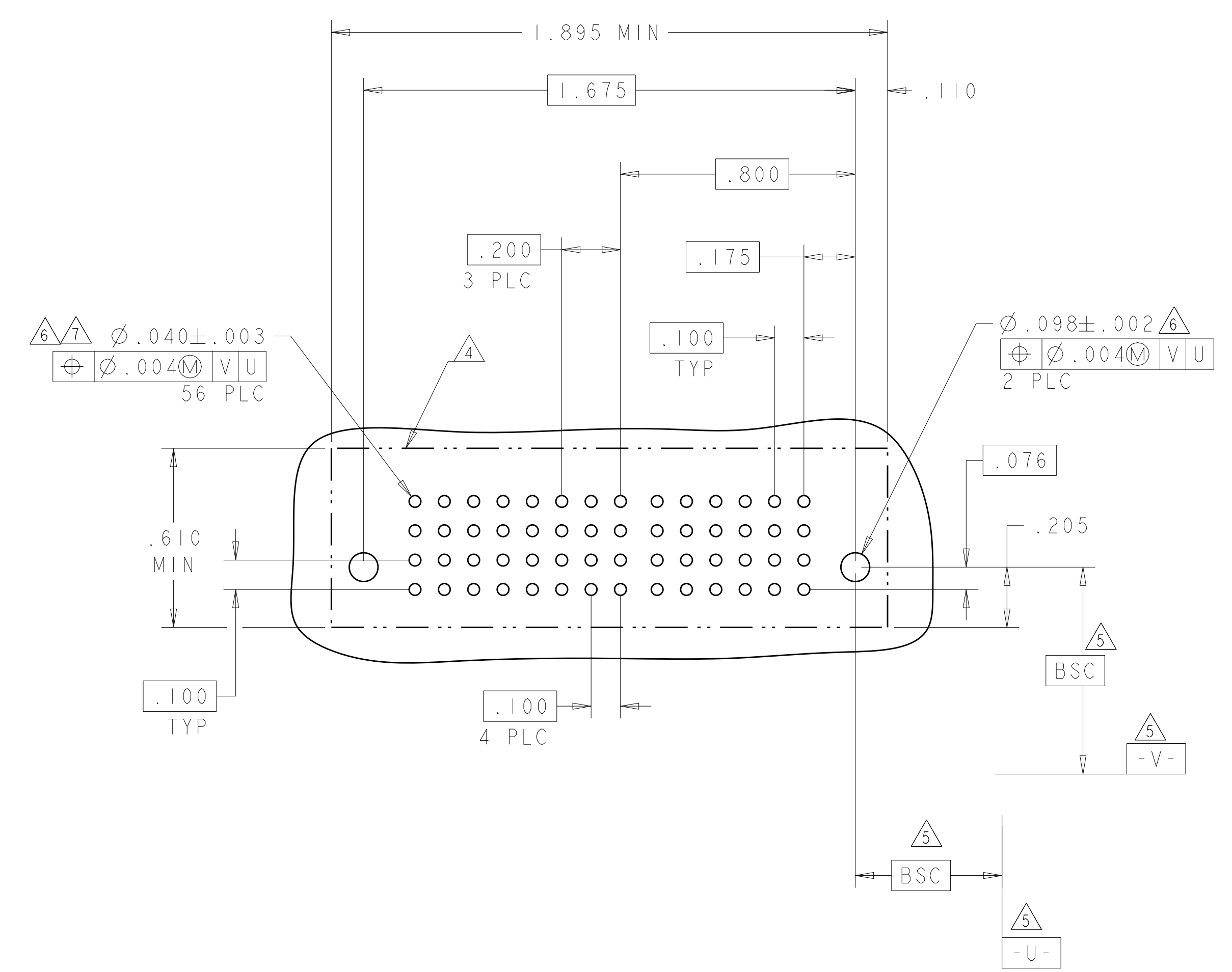
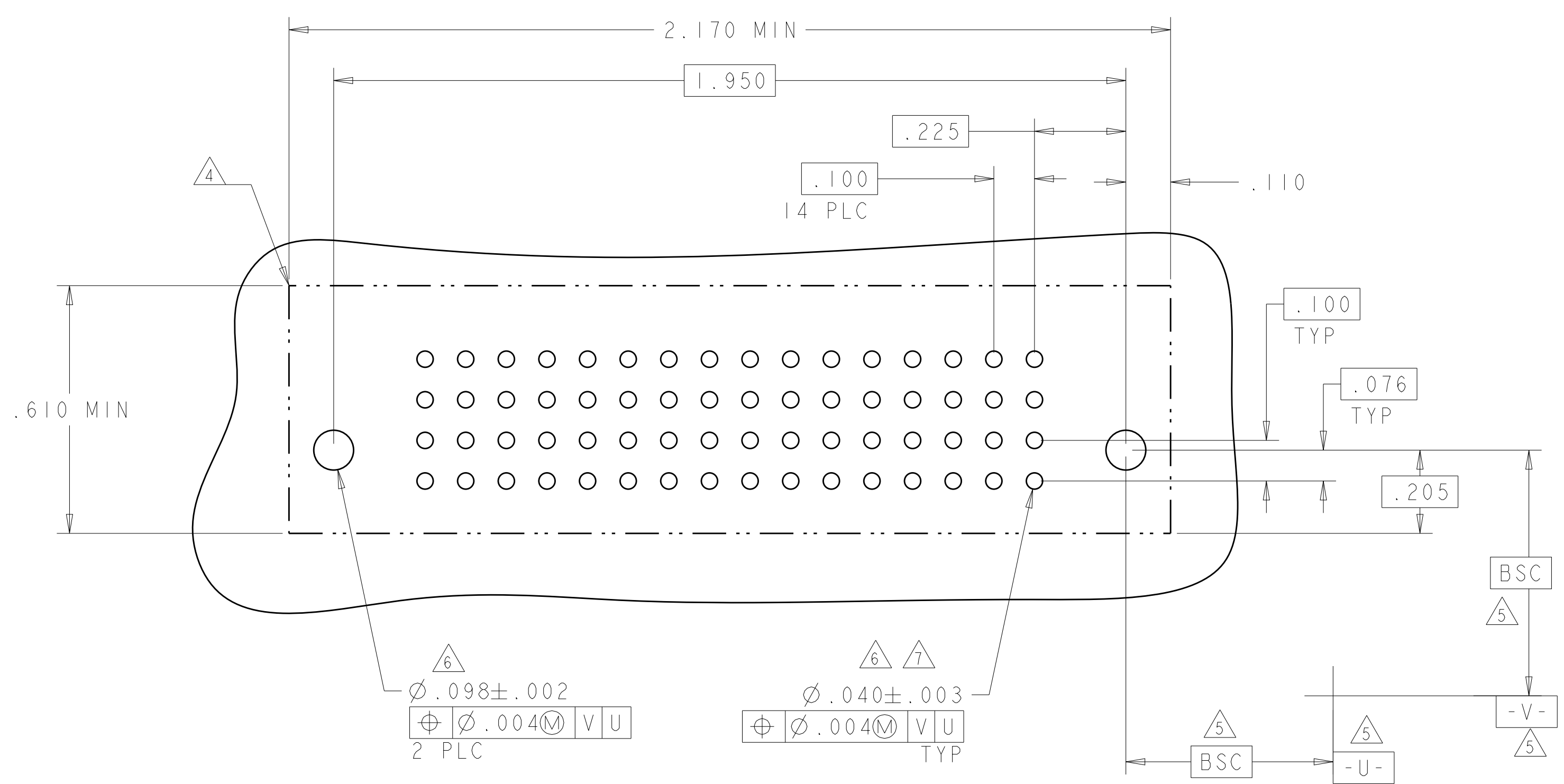

THIS DRAWING IS A CONTROLLED DOCUMENT.		DWN: C. ZHOU 20JUN2012	 TE Connectivity
DIMENSIONS: INCHES		CHK: S. ZHAO 20JUN2012	
TOLERANCES UNLESS OTHERWISE SPECIFIED:		APVD: -	NAME: VERTICAL RECEPTACLE ASSEMBLY WITH SHORT GUIDE, PRESS FIT MULTI-BEAM XLE
0 PLC ± 1 PLC ± 2 PLC ± 3 PLC ±.005 4 PLC ±.0020 ANGLES ±.7°		PRODUCT SPEC: 108-2292	RESTRICTED TO: -
MATERIAL: -		APPLICATION SPEC: 114-13251	SIZE: A1
FINISH: -		WEIGHT: -	CAGE CODE: 6450861
Customer Drawing		SCALE: 1:1	SHEET 9 OF 11 REV: G5

LOC	DIST	REVISIONS			
P	LTN	DESCRIPTION	DATE	DMN	APVD
ES	00	SEE SHEET 1			

PART NUMBER	ROWS	SIGNAL			
		4	3	2	1
1-6450861-6	D	AP	AP	AP	AP
	C	AP	AP	AP	AP
	B	AP	AP	AP	AP
	A	AP	AP	AP	AP

16S

F9

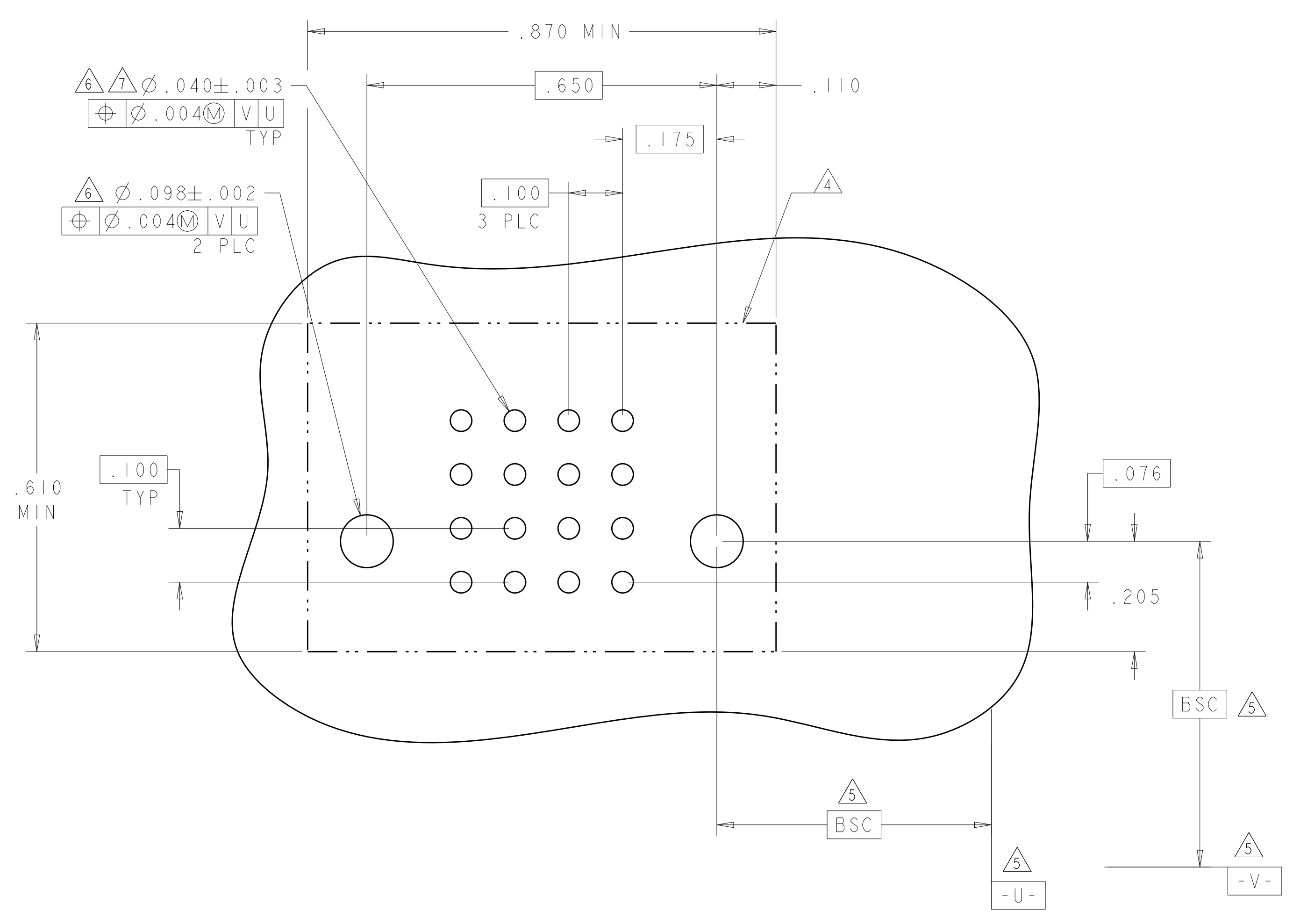

PART NUMBER	ROWS	POWER					SIGNAL			
		P4	P3	-	P2	P1	4	3	2	1
1-6450861-7	D	VS	VS	-	VS	VS	P	P	P	P
	C	VS	VS	-	VS	VS	P	P	P	P
	B	VS	VS	-	VS	VS	P	P	P	P

16S + 4P

NO CONTACT LOADED

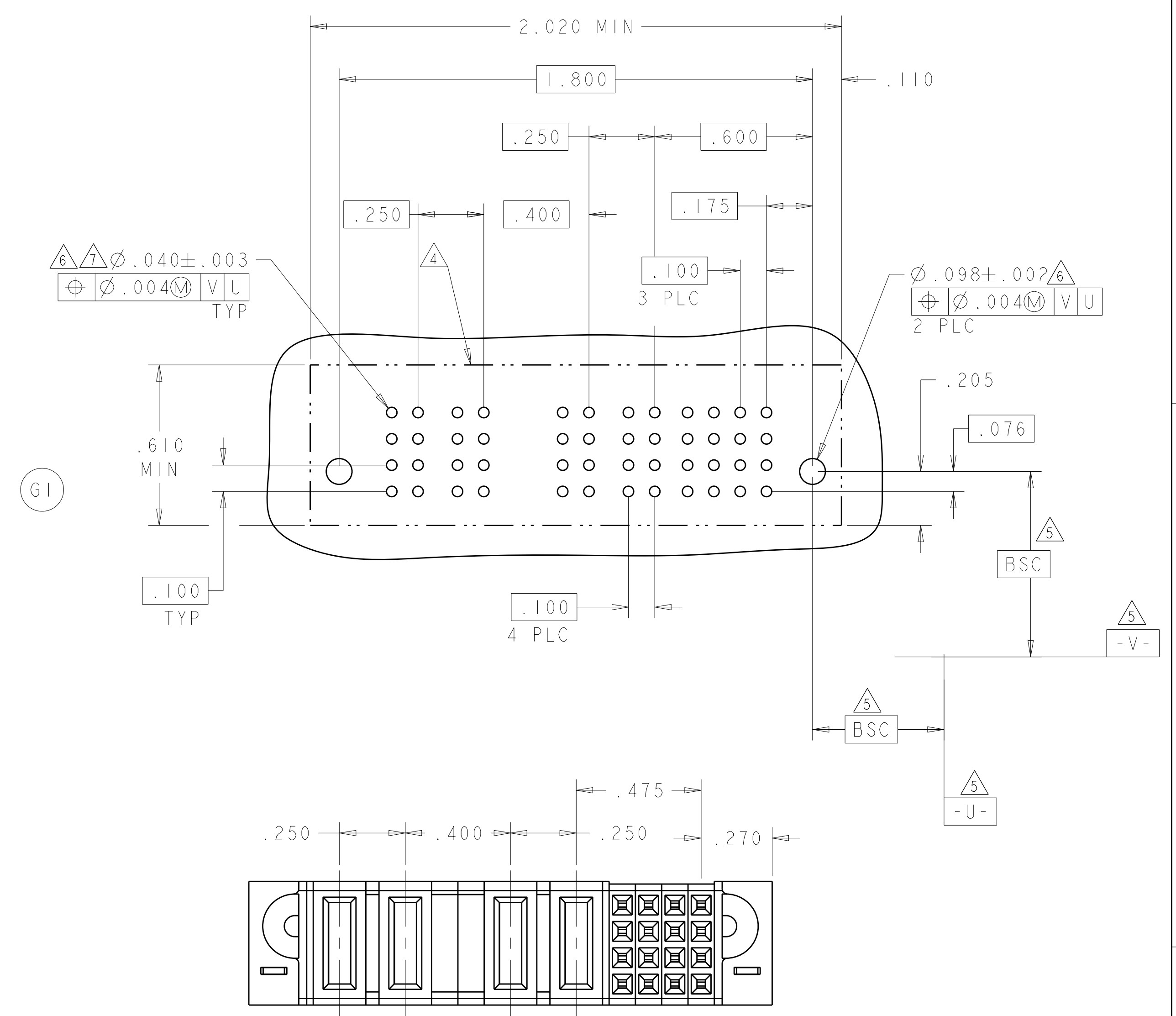

G1

PART 1-6450861-7

HD	HOLD DOWN
P	SIGNAL PRESS FIT CONTACT .115"
VS	STD POWER PRESS FIT CONTACT .115"
CODE	TAIL LENGTH
CONTACT TABLE	

THIS DRAWING IS A CONTROLLED DOCUMENT. DWG: C.ZHOU 20JUN2012, CHK: S.ZHAO 20JUN2012, APVD: -

DIMENSIONS: INCHES. TOLERANCES UNLESS OTHERWISE SPECIFIED: 0 PLC ±, 1 PLC ±, 2 PLC ±, 3 PLC ±.005, 4 PLC ±, ANGLES ±.0020, FINISH: μm*

PRODUCT SPEC: 108-2292, APPLICATION SPEC: 114-13251, WEIGHT: -

NAME: VERTICAL RECEPTACLE ASSEMBLY WITH SHORT GUIDE, PRESS FIT MULTI-BEAM XLE, SIZE: A1, CAGE CODE: 6450861, DRAWING NO: 100779, SCALE: 1:1, SHEET 10 OF 11, REV: G5

Customer Drawing

LOC	DIST	REVISIONS			
P	LTN	DESCRIPTION	DATE	DMN	APVD
-	-	SEE SHEET 1	-	-	-

PART NUMBER	ROWS	SIGNAL											
		12	11	10	9	8	7	6	5	4	3	2	1
1-6450861-8	D C B A	AP	AP	AP	AP	AP	AP	AP	AP	AP	AP	AP	AP
		AP	AP	AP	AP	AP	AP	AP	AP	AP	AP	AP	AP
		AP	AP	AP	AP	AP	AP	AP	AP	AP	AP	AP	AP
		AP	AP	AP	AP	AP	AP	AP	AP	AP	AP	AP	AP
48S		HD											HD

G5

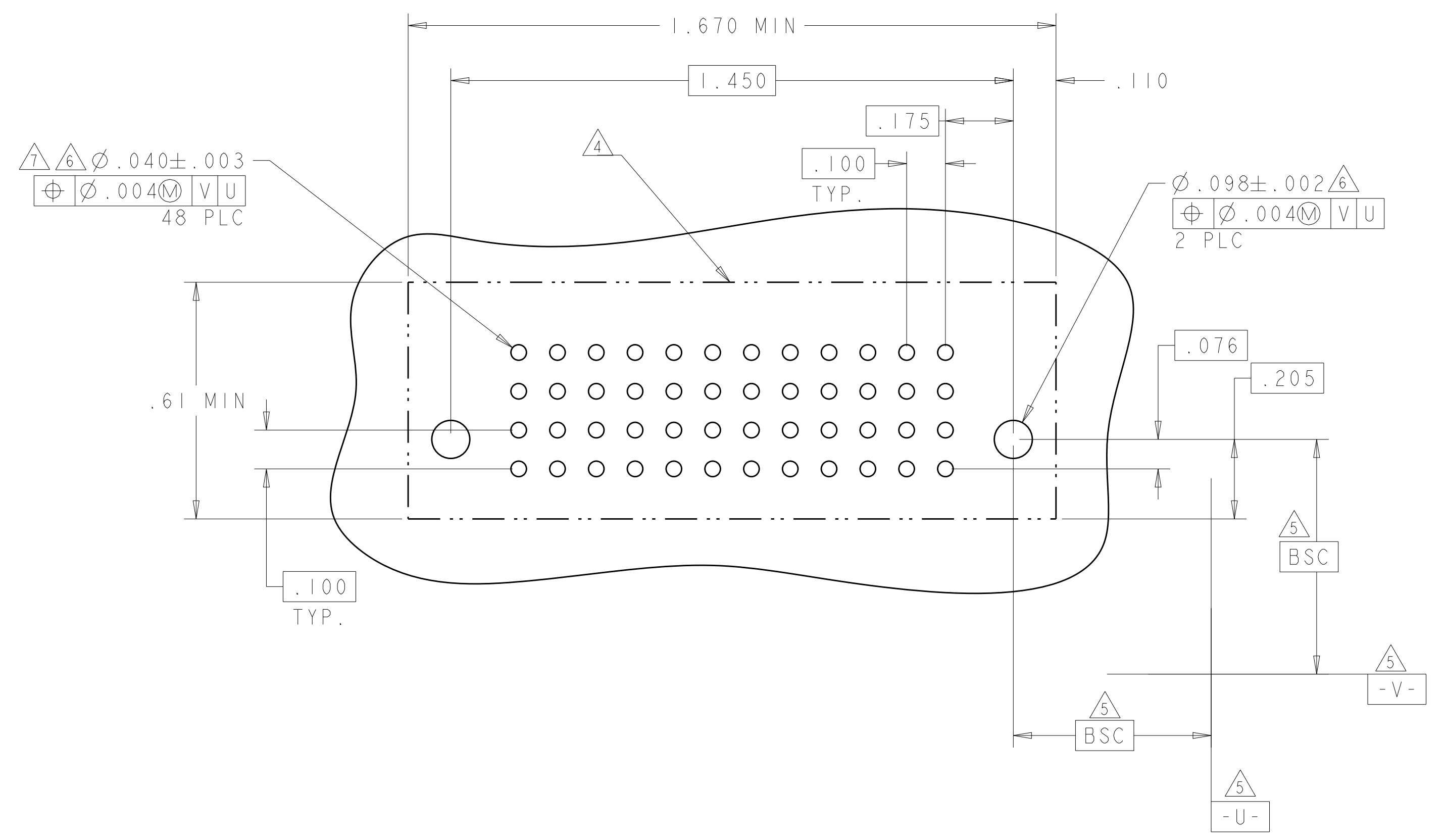

THIS DRAWING IS A CONTROLLED DOCUMENT.		DMN C. ZHOU 20JUN2012	TE Connectivity	
DIMENSIONS: INCHES		CHK S. ZHAO 20JUN2012	NAME VERTICAL RECEPTACLE ASSEMBLY WITH SHORT GUIDE, PRESS FIT MULTI-BEAM XLE	
TOLERANCES UNLESS OTHERWISE SPECIFIED:		APVD	PRODUCT SPEC	
0 PLC ±		108-2292		
1 PLC ±		APPLICATION SPEC		
2 PLC ±		114-13251		
3 PLC ±		WEIGHT		
4 PLC ±		Customer Drawing		
ANGLES ±		SCALE 1:1 SHEET 11 OF 11 REV G5		
FINISH		SIZE CAGE CODE DRAWING NO A100779C=6450861		



Компания «ЭлектроПласт» предлагает заключение долгосрочных отношений при поставках импортных электронных компонентов на взаимовыгодных условиях!

Наши преимущества:

- Оперативные поставки широкого спектра электронных компонентов отечественного и импортного производства напрямую от производителей и с крупнейших мировых складов;
- Поставка более 17-ти миллионов наименований электронных компонентов;
- Поставка сложных, дефицитных, либо снятых с производства позиций;
- Оперативные сроки поставки под заказ (от 5 рабочих дней);
- Экспресс доставка в любую точку России;
- Техническая поддержка проекта, помощь в подборе аналогов, поставка прототипов;
- Система менеджмента качества сертифицирована по Международному стандарту ISO 9001;
- Лицензия ФСБ на осуществление работ с использованием сведений, составляющих государственную тайну;
- Поставка специализированных компонентов (Xilinx, Altera, Analog Devices, Intersil, Interpoint, Microsemi, Aeroflex, Peregrine, Syfer, Eurofarad, Texas Instrument, Miteq, Cobham, E2V, MA-COM, Hittite, Mini-Circuits, General Dynamics и др.);

Помимо этого, одним из направлений компании «ЭлектроПласт» является направление «Источники питания». Мы предлагаем Вам помощь Конструкторского отдела:

- Подбор оптимального решения, техническое обоснование при выборе компонента;
- Подбор аналогов;
- Консультации по применению компонента;
- Поставка образцов и прототипов;
- Техническая поддержка проекта;
- Защита от снятия компонента с производства.



Как с нами связаться

Телефон: 8 (812) 309 58 32 (многоканальный)

Факс: 8 (812) 320-02-42

Электронная почта: org@eplast1.ru

Адрес: 198099, г. Санкт-Петербург, ул. Калинина, дом 2, корпус 4, литера А.