

## FEATURES

Low input voltage range: 1.4 V to 3.6 V

### Load switch

Low  $R_{DS(on,L)}$  of 65 m $\Omega$  at 3.6 V

500 mA continuous operating current

### 4 SPST normally open signal switches

$R_{DS(on,S)}$  of 3  $\Omega$  at 1.8 V

Internal charge pump for constant signal switch  $R_{DS(on)}$

Output discharge resistance ( $R_{DIS}$ ): 215  $\Omega$  at the output side of the load switch and each analog signal switch output

Built-in level shift for control logic that can operate by a 1.2 V logic

Ultralow shutdown current: 0.7  $\mu$ A

Ultrasmall 1.2 mm  $\times$  1.6 mm  $\times$  0.5 mm, 12-ball,

0.4 mm pitch WLCSP

## APPLICATIONS

Mobile phones

SIM card disconnect switches

Digital cameras and audio devices

Portable and battery-powered equipment

## FUNCTIONAL BLOCK DIAGRAM

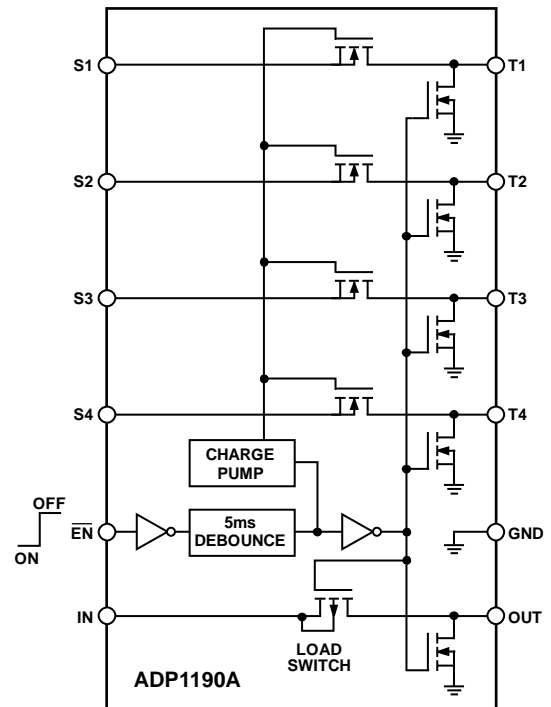

Figure 1.

11539-001

## GENERAL DESCRIPTION

The [ADP1190A](#) is an integrated high-side load switch with four signal switches designed for operation from 1.4 V to 3.6 V. This load switch provides power domain isolation for extended power battery life. The load switch is a low on-resistance P-channel MOSFET that supports up to 500 mA of continuous load current and minimizes power loss. Integrated with the load switch are four normally open, 3  $\Omega$  single pole, single throw (SPST) signal switches controlled by the charge pump.

Beyond its excellent operating performance, the [ADP1190A](#) occupies minimal printed circuit board (PCB) space with an area less than 1.92 mm<sup>2</sup> and a height of 0.50 mm. The [ADP1190A](#) is available in an ultrasmall 1.2 mm  $\times$  1.6 mm  $\times$  0.5 mm, 12-ball, 0.4 mm pitch WLCSP.

**TABLE OF CONTENTS**

Features .....	1	Pin Configuration and Function Descriptions.....	5
Applications.....	1	Typical Performance Characteristics .....	6
Functional Block Diagram .....	1	Theory of Operation .....	9
General Description .....	1	Outline Dimensions .....	11
Revision History .....	2	Ordering Guide .....	11
Specifications.....	3		
Absolute Maximum Ratings.....	4		
Thermal Data .....	4		
Thermal Resistance .....	4		
ESD Caution.....	4		

**REVISION HISTORY**

9/13—Revision 0: Initial Version

## SPECIFICATIONS

$V_{IN} = 1.8\text{ V}$ ,  $V_{EN} = V_{IN}$ ,  $I_{LOAD} = 200\text{ mA}$ ,  $C_{IN} = C_{OUT} = 1\text{ }\mu\text{F}$ ,  $T_A = 25^\circ\text{C}$ , unless otherwise noted.

Table 1.

Parameter	Symbol	Test Conditions/Comments	Min	Typ	Max	Unit
INPUT VOLTAGE RANGE	$V_{IN}$	$T_J = -40^\circ\text{C}$ to $+85^\circ\text{C}$	1.4		3.6	V
EN INPUT						
$\overline{\text{EN}}$ Input Threshold	$V_{\text{EN\_TH}}$	$1.4\text{ V} < V_{IN} < 1.8\text{ V}$ , $T_J = -40^\circ\text{C}$ to $+85^\circ\text{C}$ (active low)	0.35		1.2	V
Logic High Voltage	$V_{IH}$	$1.8\text{ V} \leq V_{IN} \leq 3.6\text{ V}$ , $T_J = -40^\circ\text{C}$ to $+85^\circ\text{C}$ (active low)	0.45		1.2	V
Logic Low Voltage	$V_{IL}$	$1.4\text{ V} \leq V_{IN} \leq 3.6\text{ V}$ (chip enable)			0.35	V
CURRENT						
Shutdown Current	$I_{\text{OFF}}$	$\overline{\text{EN}} = V_{IN}$ or open		0.7		$\mu\text{A}$
Analog Switch Off Current	$I_{\text{A\_OFF}}$	$\overline{\text{EN}} = V_{IN}$ or open, $T_J = -40^\circ\text{C}$ to $+85^\circ\text{C}$ Into S1, $\overline{\text{EN}} = V_{IN}$			2	$\mu\text{A}$
LOAD SWITCH, $V_{IN}$ TO $V_{\text{OUT}}$ RESISTANCE	$R_{\text{DS\_ON\_L}}$	$V_{IN} = 3.6\text{ V}$ , $I_{\text{LOAD}} = 200\text{ mA}$ , $\overline{\text{EN}} = \text{GND}$ $V_{IN} = 2.5\text{ V}$ , $I_{\text{LOAD}} = 200\text{ mA}$ , $\overline{\text{EN}} = \text{GND}$ $V_{IN} = 1.8\text{ V}$ , $I_{\text{LOAD}} = 200\text{ mA}$ , $\overline{\text{EN}} = \text{GND}$ , $T_J = -40^\circ\text{C}$ to $+85^\circ\text{C}$		65		$\text{m}\Omega$
SIGNAL SWITCH RESISTANCE	$R_{\text{DS\_ON\_S}}$	Maximum value of analog input sweep $V_{IN} = 3.6\text{ V}$ , $I_{\text{LOAD}} = 10\text{ mA}$ , $\overline{\text{EN}} = \text{GND}$ $V_{IN} = 2.5\text{ V}$ , $I_{\text{LOAD}} = 10\text{ mA}$ , $\overline{\text{EN}} = \text{GND}$ $V_{IN} = 1.8\text{ V}$ , $I_{\text{LOAD}} = 10\text{ mA}$ , $\overline{\text{EN}} = \text{GND}$		3		$\Omega$
RDS Flatness		$V_{IN} = 3.6\text{ V}$ , $I_{\text{LOAD}} = 10\text{ mA}$ , $\overline{\text{EN}} = \text{GND}$ $V_{IN} = 1.8\text{ V}$ , $I_{\text{LOAD}} = 10\text{ mA}$ , $\overline{\text{EN}} = \text{GND}$		0.2		$\Omega$
SIGNAL SWITCH INPUT CAPACITANCE	$C_{IN}$			10		pF
OUTPUT DISCHARGE RESISTANCE	$R_{\text{DIS}}$	At the output side of the load switch and each analog signal switch output, T1, T2, T3, and T4		215		$\Omega$
-3 dB BANDWIDTH	$\text{BW}_{-3\text{ dB}}$	$V_{IN} = 3.3\text{ V}$ , $R_{\text{LOAD}} = 50\text{ }\Omega$ , $C_{\text{LOAD}} = 5\text{ pF}$		50		MHz
$V_{\text{OUT}}$ TIME						
Turn-On Delay Time	$t_{\text{ON\_DLY}}$	$I_{\text{LOAD}} = 200\text{ mA}$ , $\overline{\text{EN}} = \text{GND}$ , $C_{\text{LOAD}} = 0.1\text{ }\mu\text{F}$		5		ms
Turn-Off Delay Time	$t_{\text{OFF\_DLY}}$	$V_{IN} = 3.6\text{ V}$ , $I_{\text{LOAD}} = 200\text{ mA}$ , $\overline{\text{EN}} = 1.5\text{ V}$ , $C_{\text{LOAD}} = 0.1\text{ }\mu\text{F}$		2		$\mu\text{s}$

### Timing Diagram

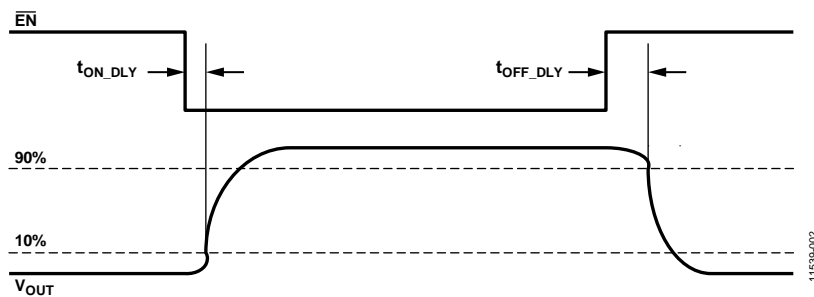

Figure 2. Timing Diagram

## ABSOLUTE MAXIMUM RATINGS

Table 2.

Parameter	Rating
V <sub>IN</sub> to GND	−0.3 V to +4.0 V
V <sub>OUT</sub> to GND	−0.3 V to V <sub>IN</sub>
S <sub>X</sub> to GND	−0.3 V to +4.0 V
T <sub>X</sub> to GND	−0.3 V to +4.0 V
EN to GND	−0.3 V to +4.0 V
Continuous Load Switch Current	
T <sub>A</sub> = 25°C	±1 A
T <sub>A</sub> = 85°C	±500 mA
Continuous Diode Current	−50 mA
Storage Temperature Range	−65°C to +150°C
Junction Temperature	150°C
Operating Temperature Range	
Junction Temperature Range	−40°C to +125°C
Ambient Temperature Range	−40°C to +85°C
Soldering Conditions	JEDEC J-STD-020

Stresses above those listed under Absolute Maximum Ratings may cause permanent damage to the device. This is a stress rating only; functional operation of the device at these or any other conditions above those indicated in the operational section of this specification is not implied. Exposure to absolute maximum rating conditions for extended periods may affect device reliability.

### THERMAL DATA

Absolute maximum ratings apply individually only, not in combination. The ADP1190A can be damaged when the junction temperature limits are exceeded. Monitoring ambient temperature does not guarantee that the junction temperature (T<sub>J</sub>) is within the specified temperature limits. In applications with high power dissipation and poor thermal resistance, the maximum ambient temperature may need to be derated.

In applications with moderate power dissipation and low PCB thermal resistance, the maximum ambient temperature can exceed the maximum limit as long as the junction temperature is within specification limits. The T<sub>J</sub> of the device is dependent on the ambient temperature (T<sub>A</sub>), the power dissipation of the device (P<sub>D</sub>), and the junction-to-ambient thermal resistance of the package (θ<sub>JA</sub>).

Maximum T<sub>J</sub> is calculated from T<sub>A</sub> and P<sub>D</sub> using the formula

$$T_J = T_A + (P_D \times \theta_{JA})$$

The junction-to-ambient thermal resistance (θ<sub>JA</sub>) of the package is based on modeling and calculation using a 4-layer board. The junction-to-ambient thermal resistance is highly dependent on the application and board layout. In applications where high maximum power dissipation exists, close attention to thermal board design is required. The value of θ<sub>JA</sub> can vary, depending on PCB material, layout, and environmental conditions. The specified value of θ<sub>JA</sub> is based on a 4-layer, 4 inch × 3 inch circuit board. See JESD51-7 and JESD51-9 for detailed information on the board construction. For additional information, see the [AN-617 Application Note](#), *Wafer Level Chip Scale Package*.

Ψ<sub>JB</sub> is the junction-to-board thermal characterization parameter with units of °C/W. Ψ<sub>JB</sub> of the package is based on modeling and calculation using a 4-layer board. JESD51-12, *Guidelines for Reporting and Using Electronic Package Thermal Information*, states that thermal characterization parameters are not the same as thermal resistances. Ψ<sub>JB</sub> measures the component power flowing through multiple thermal paths rather than through a single path as in thermal resistance (θ<sub>JB</sub>). Therefore, Ψ<sub>JB</sub> thermal paths include convection from the top of the package as well as radiation from the package, factors that make Ψ<sub>JB</sub> more useful in real-world applications. Maximum T<sub>J</sub> is calculated from the board temperature (T<sub>B</sub>) and P<sub>D</sub> using the formula

$$T_J = T_B + (P_D \times \Psi_{JB})$$

See JESD51-8 and JESD51-12 for more detailed information about Ψ<sub>JB</sub>.

### THERMAL RESISTANCE

θ<sub>JA</sub> and Ψ<sub>JB</sub> are specified for the worst-case conditions, that is, a device soldered in a circuit board for surface-mount packages.

Table 3. Thermal Resistance

Package Type	θ <sub>JA</sub>	Ψ <sub>JB</sub>	Unit
12-Ball WLCSP	130	29.2	°C/W

### ESD CAUTION



**ESD (electrostatic discharge) sensitive device.** Charged devices and circuit boards can discharge without detection. Although this product features patented or proprietary protection circuitry, damage may occur on devices subjected to high energy ESD. Therefore, proper ESD precautions should be taken to avoid performance degradation or loss of functionality.

## PIN CONFIGURATION AND FUNCTION DESCRIPTIONS

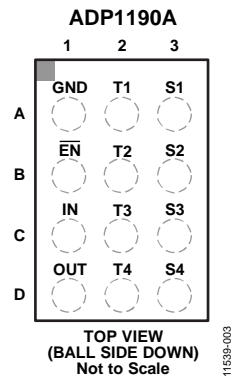

Figure 3. Pin Configuration

Table 4. Pin Function Descriptions

Pin No.	Mnemonic	Description
A1	GND	Ground.
B1	$\overline{\text{EN}}$	Enable Input, Active Low.
C1	IN	Input Voltage.
D1	OUT	Load Switch Output Voltage.
A2	T1	Channel 1 Analog Switch. Connect Pin A2 to the SIM card socket (has active discharge).
B2	T2	Channel 2 Analog Switch. Connect Pin B2 to the SIM card socket (has active discharge).
C2	T3	Channel 3 Analog Switch. Connect Pin C2 to the SIM card socket (has active discharge).
D2	T4	Channel 4 Analog Switch. Connect Pin D2 to the SIM card socket (has active discharge).
A3	S1	Channel 1 Analog Switch. Connect Pin A3 to the microcontroller.
B3	S2	Channel 2 Analog Switch. Connect Pin B3 to the microcontroller.
C3	S3	Channel 3 Analog Switch. Connect Pin C3 to the microcontroller.
D3	S4	Channel 4 Analog Switch. Connect Pin D3 to the microcontroller.

# TYPICAL PERFORMANCE CHARACTERISTICS

$V_{IN} = 1.8\text{ V}$ ,  $V_{EN} = V_{IN}$ ,  $I_{LOAD} = 200\text{ mA}$ ,  $C_{IN} = C_{OUT} = 1\text{ }\mu\text{F}$ ,  $T_A = 25^\circ\text{C}$ , unless otherwise noted.

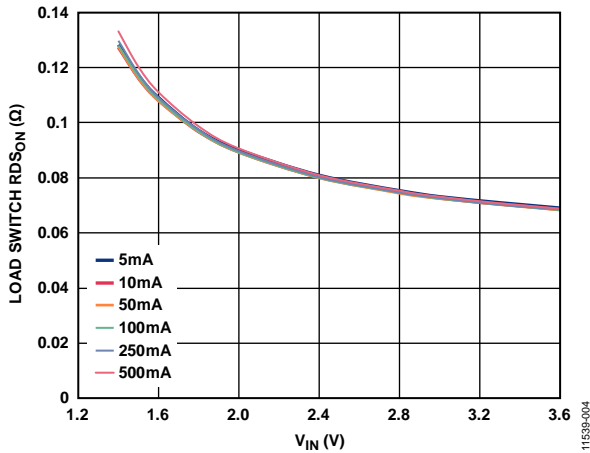

Figure 4. Load Switch  $R_{DS(ON)}$  vs. Input Voltage ( $V_{IN}$ ) for Different Load Currents

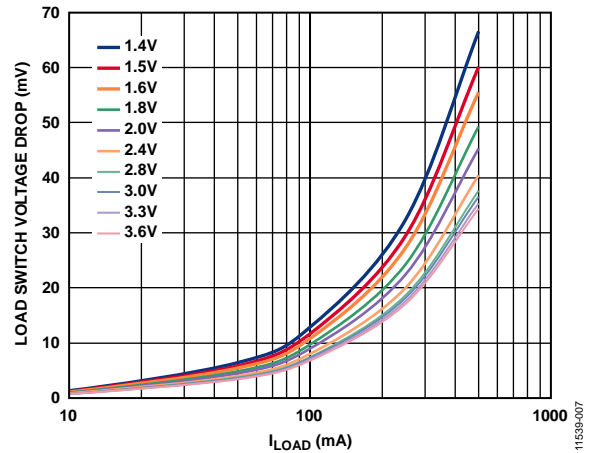

Figure 7. Load Switch Voltage Drop vs. Load Current ( $I_{LOAD}$ ) for Different Input Voltages

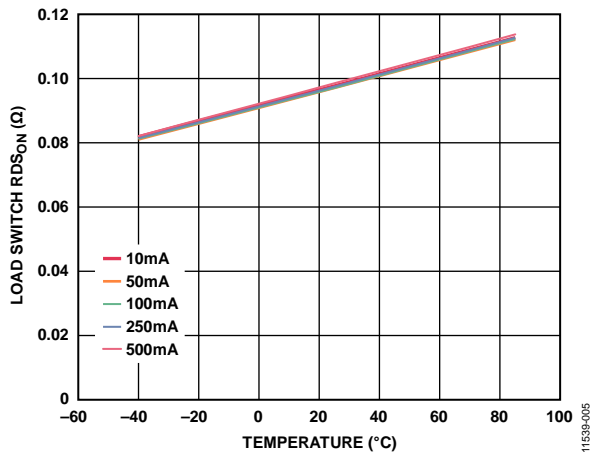

Figure 5. Load Switch  $R_{DS(ON)}$  vs. Temperature for Different Load Currents,  $V_{IN} = 1.8\text{ V}$

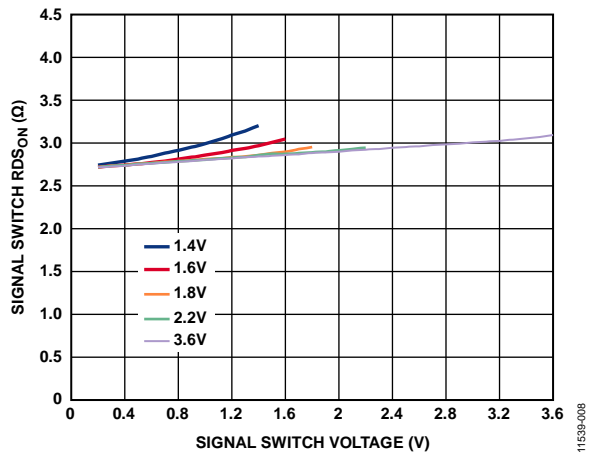

Figure 8. Signal Switch  $R_{DS(ON)}$  vs. Signal Switch Voltage, Different Input Voltages

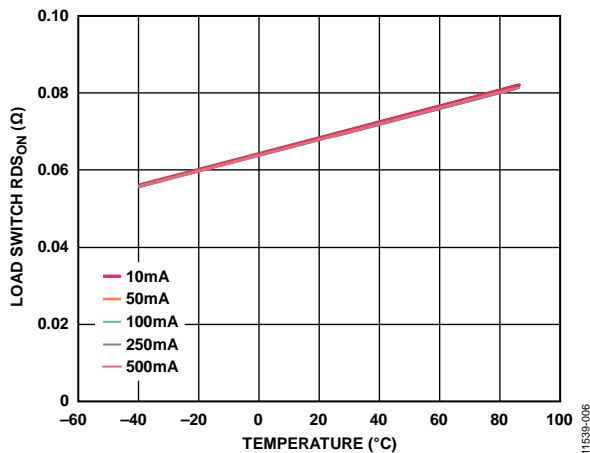

Figure 6. Load Switch  $R_{DS(ON)}$  vs. Temperature for Different Load Currents,  $V_{IN} = 3.6\text{ V}$

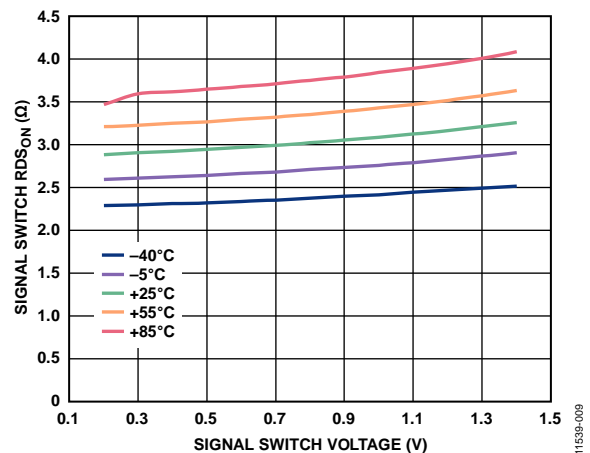

Figure 9. Signal Switch  $R_{DS(ON)}$  vs. Signal Switch Voltage for Various Temperatures,  $V_{IN} = 1.4\text{ V}$

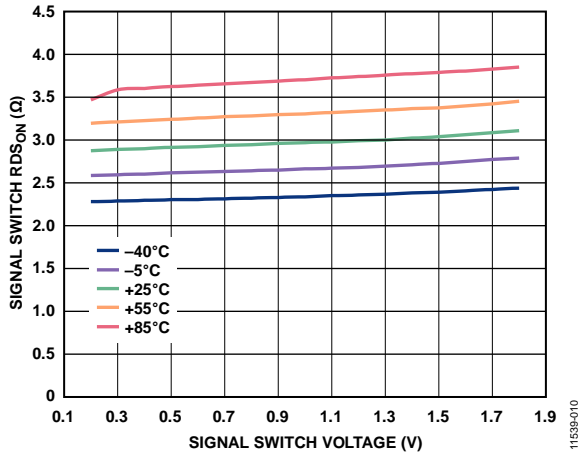

Figure 10. Signal Switch  $R_{DS_{ON}}$  vs. Signal Switch Voltage for Various Temperatures,  $V_{IN} = 1.8 V$

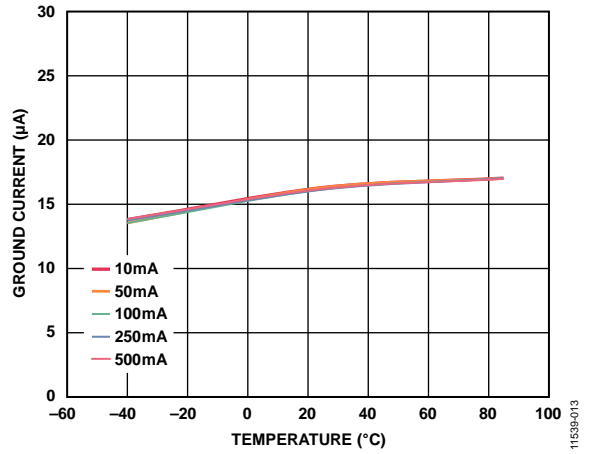

Figure 13. Ground Current vs. Temperature for Different Load Currents,  $V_{IN} = 1.8 V$

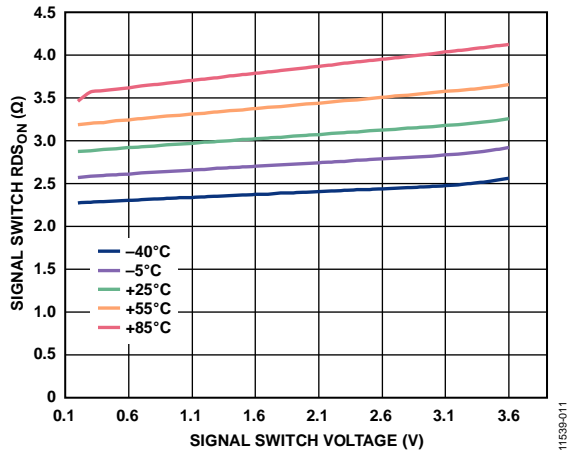

Figure 11. Signal Switch  $R_{DS_{ON}}$  vs. Signal Switch Voltage for Various Temperatures,  $V_{IN} = 3.6 V$

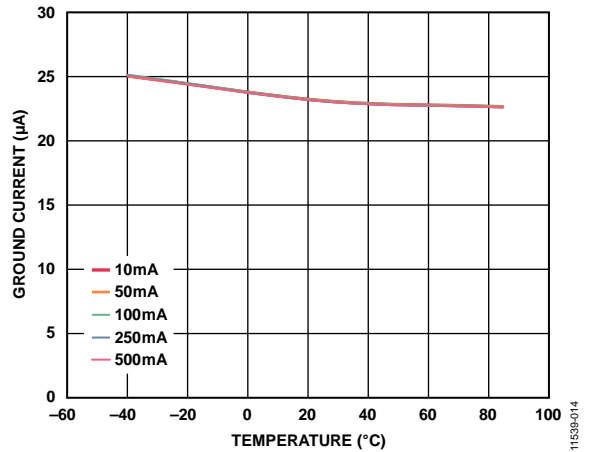

Figure 14. Ground Current vs. Temperature for Different Load Currents,  $V_{IN} = 3.6 V$

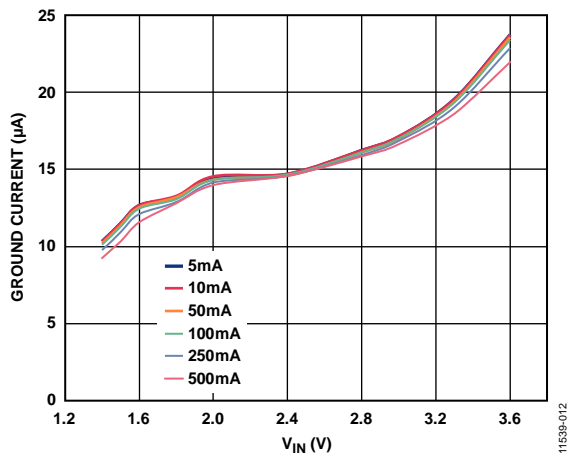

Figure 12. Ground Current vs. Input Voltage ( $V_{IN}$ ) for Different Load Currents

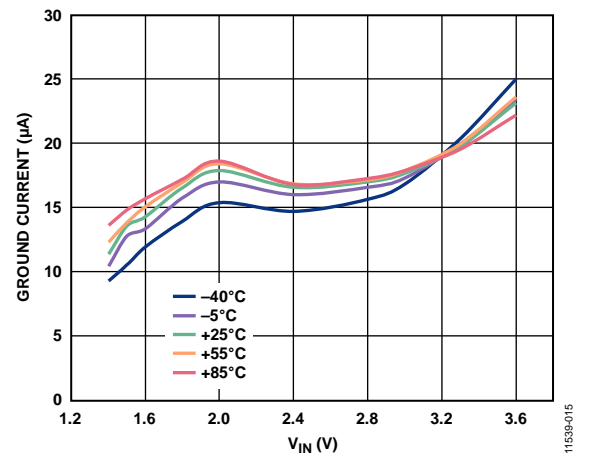

Figure 15. No Load Ground Current vs. Input Voltage ( $V_{IN}$ ) for Various Temperatures

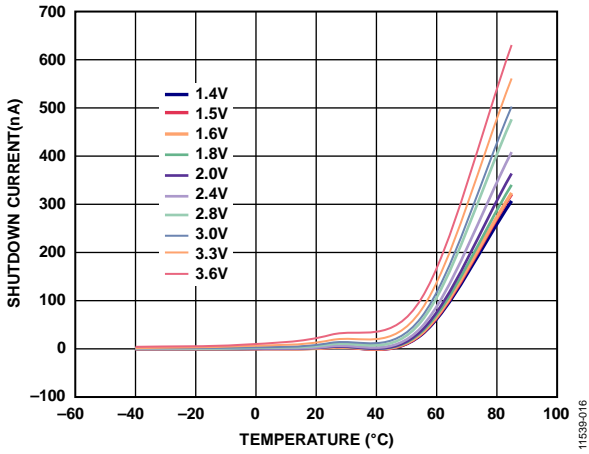

Figure 16. Shutdown Current vs. Temperature for Different Input Voltages

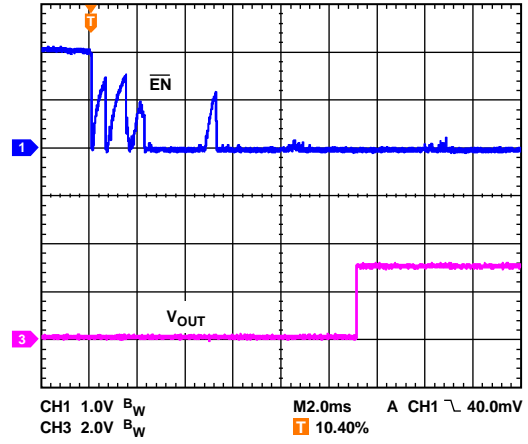

Figure 19. Enable Debounce Behavior,  $V_{IN} = 1.8 V$

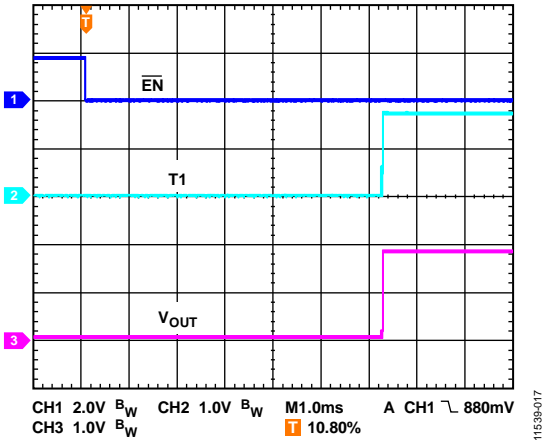

Figure 17. Typical Turn-On Delay Time,  $V_{IN} = 1.8 V$ , 50 mA Load

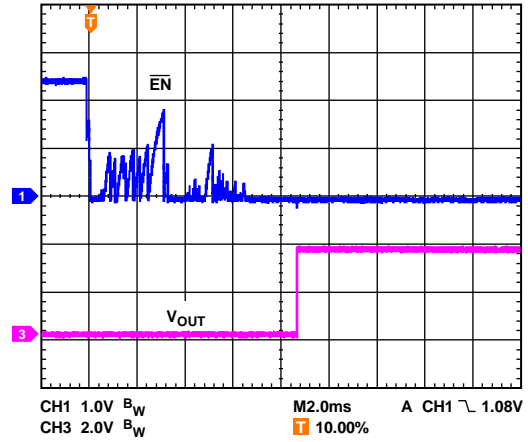

Figure 20. Enable Debounce Behavior,  $V_{IN} = 3.6 V$

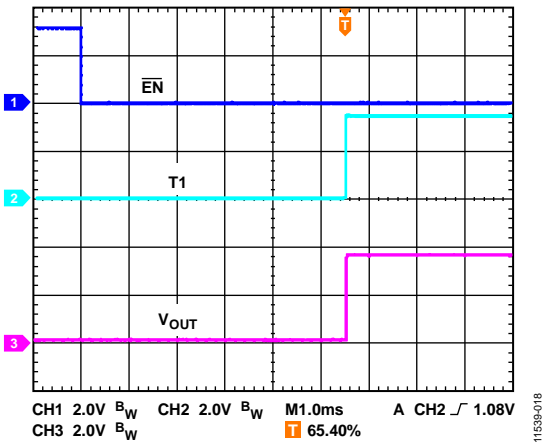

Figure 18. Typical Turn-On Delay Time,  $V_{IN} = 3.6 V$ , 100 mA Load



## THEORY OF OPERATION

The **ADP1190A** is a high-side load switch integrated with four signal switches. The load switch and signal switches are turned on by a low signal on the  $\overline{\text{EN}}$  pin. When the device is disabled, the T1 to T4 pins are actively pulled down with a nominal resistance of  $215\ \Omega$ . There is a 5 ms debounce counter on  $\overline{\text{EN}}$  for use with a mechanical  $\overline{\text{EN}}$  switch. That is, hold  $\overline{\text{EN}}$  low for 5 ms before the device is enabled. If  $\overline{\text{EN}}$  transitions high before this timeout, the counter is reset and starts a new 5 ms count.

The signal paths are N-channel MOSFETs with  $3\ \Omega$  on resistance. Break-before-make logic control ensures that the active pull-down is off before the signal path is enabled.

The **ADP1190A** also has an internal charge pump that provides a regulated voltage at the gates of the N-channel MOSFETs, resulting in a more stable signal switch on resistance over different input voltages and temperature.

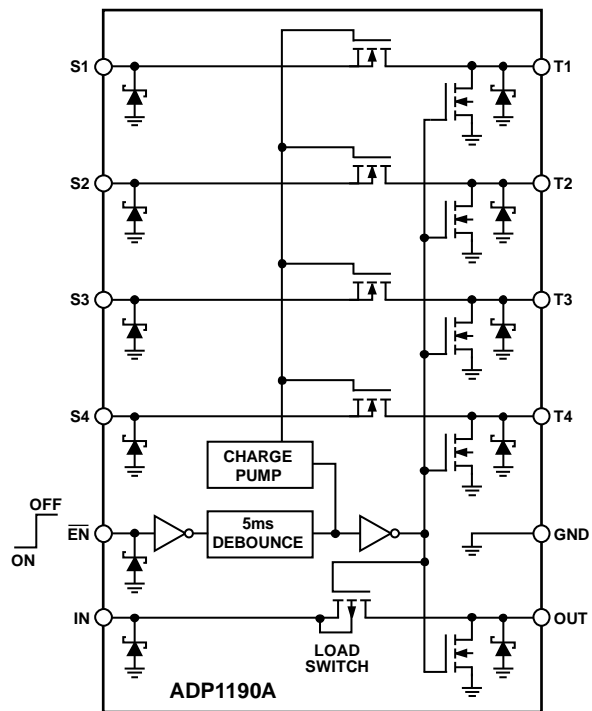
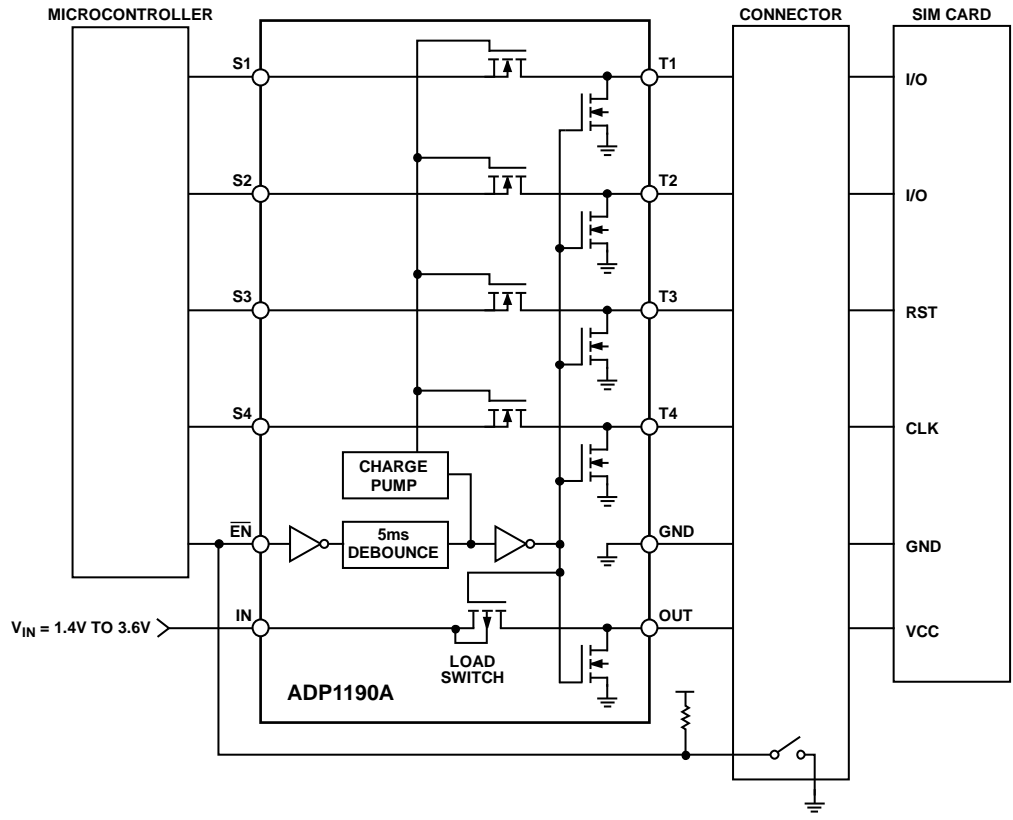

Figure 21. Block Diagram with ESD Protection Devices

11539-021



11539-022

Figure 22. Typical Application Diagram

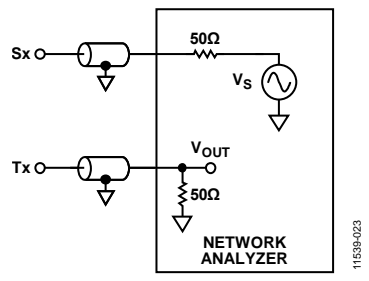

11539-023

Figure 23. Bandwidth Measurement Setup

OUTLINE DIMENSIONS

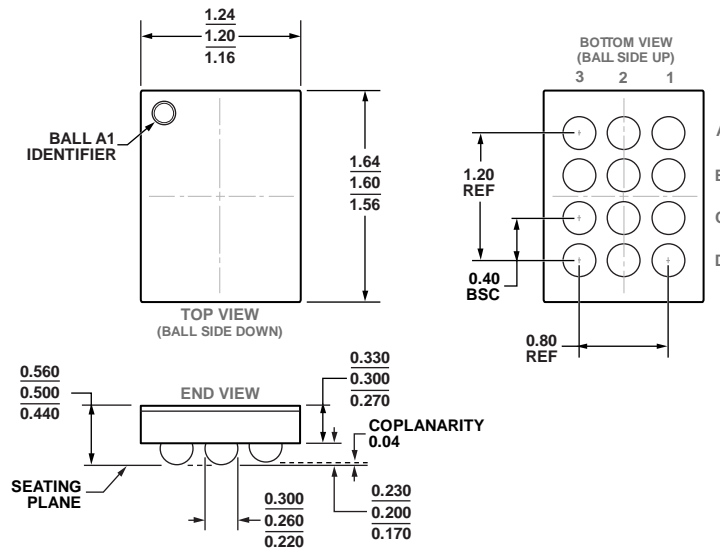

02-22-2013-A

Figure 24. 12-Ball Wafer Level Chip Scale Package [WLCSP]  
(CB-12-10)  
Dimensions shown in millimeters

ORDERING GUIDE

Model <sup>1</sup>	Temperature Range	Package Description	Package Option	Branding
ADP1190ACBZ-R7	-40°C to +85°C	12-Ball Wafer Level Chip Scale Package [WLCSP]	CB-12-10	LNW

<sup>1</sup> Z = RoHS Compliant Part.

**NOTES**



Компания «ЭлектроПласт» предлагает заключение долгосрочных отношений при поставках импортных электронных компонентов на взаимовыгодных условиях!

Наши преимущества:

- Оперативные поставки широкого спектра электронных компонентов отечественного и импортного производства напрямую от производителей и с крупнейших мировых складов;
- Поставка более 17-ти миллионов наименований электронных компонентов;
- Поставка сложных, дефицитных, либо снятых с производства позиций;
- Оперативные сроки поставки под заказ (от 5 рабочих дней);
- Экспресс доставка в любую точку России;
- Техническая поддержка проекта, помощь в подборе аналогов, поставка прототипов;
- Система менеджмента качества сертифицирована по Международному стандарту ISO 9001;
- Лицензия ФСБ на осуществление работ с использованием сведений, составляющих государственную тайну;
- Поставка специализированных компонентов (Xilinx, Altera, Analog Devices, Intersil, Interpoint, Microsemi, Aeroflex, Peregrine, Syfer, Eurofarad, Texas Instrument, Miteq, Cobham, E2V, MA-COM, Hittite, Mini-Circuits, General Dynamics и др.);

Помимо этого, одним из направлений компании «ЭлектроПласт» является направление «Источники питания». Мы предлагаем Вам помощь Конструкторского отдела:

- Подбор оптимального решения, техническое обоснование при выборе компонента;
- Подбор аналогов;
- Консультации по применению компонента;
- Поставка образцов и прототипов;
- Техническая поддержка проекта;
- Защита от снятия компонента с производства.



#### Как с нами связаться

**Телефон:** 8 (812) 309 58 32 (многоканальный)

**Факс:** 8 (812) 320-02-42

**Электронная почта:** [org@eplast1.ru](mailto:org@eplast1.ru)

**Адрес:** 198099, г. Санкт-Петербург, ул. Калинина, дом 2, корпус 4, литера А.