

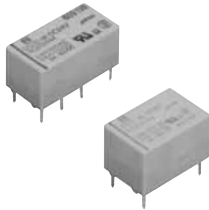

### High Reliability Relay for Various Applications

## DS RELAYS



### FEATURES

- 1. Breakthrough height of 9.8 mm .386 inch beats the 10 mm .394 inch limit**  
1c and 2c all have the same height (9.8 mm .386 inch). The width of the relay is also the same (9.9 mm .390 inch). Since the only size variable is the length, the shared form makes mounting on printed printing wiring boards easy.
- 2. Suitable for use in difficult environments**  
Epoxy resin seals the parts and cut off the external atmosphere, thus enabling use in difficult environments.
- 3. Can be used with automatic solder and automatic wash systems**  
Automatic soldering and automatic washing can be carried out once the parts are mounted on PC boards.
- 4. Gold-clad twin contacts ensure high reliability**  
Highly stable gold cladding on the contacts ensures that contact resistance changes little over time. Furthermore, the use of twin contacts, a configuration that performs with superior contact reliability, ensures extremely low contact failure rates even under low level loads.

- 5. Polarized magnetic circuits realize resistance to shock and vibration**  
High-performance polarized magnetic circuits that utilize the energy of permanent magnets have made it possible to create relays with strong resistance to shock and vibration.
- 6. DIL terminal array enables use of IC sockets**
- 7. Widening scope of application with multicontact latching**  
In addition to single side stable types, you can take advantage of the memory of functions of convenient 2 coil latching relays.

### TYPICAL APPLICATIONS

Besides telecommunications, measuring devices, office equipment, computers and related equipment, DS relays are also recommended for a broad range of applications including business devices, audio systems, and industrial equipment.

RoHS compliant

### ORDERING INFORMATION

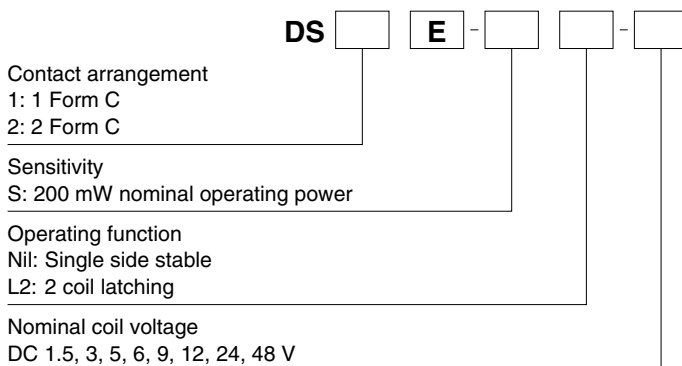

Note: \* Nominal coil voltage 1.5V type are 1 Form C only.

## TYPES

### 1. High sensitivity type

| Contact arrangement | Nominal coil voltage | Single side stable type | 2 coil latching type |
|---------------------|----------------------|-------------------------|----------------------|
|                     |                      | Part No.                | Part No.             |
| 1 Form C            | 1.5V DC              | DS1E-S-DC1.5V           | DS1E-SL2-DC1.5V      |
|                     | 3V DC                | DS1E-S-DC3V             | DS1E-SL2-DC3V        |
|                     | 5V DC                | DS1E-S-DC5V             | DS1E-SL2-DC5V        |
|                     | 6V DC                | DS1E-S-DC6V             | DS1E-SL2-DC6V        |
|                     | 9V DC                | DS1E-S-DC9V             | DS1E-SL2-DC9V        |
|                     | 12V DC               | DS1E-S-DC12V            | DS1E-SL2-DC12V       |
|                     | 24V DC               | DS1E-S-DC24V            | DS1E-SL2-DC24V       |
| 2 Form C            | 48V DC               | DS1E-S-DC48V            | DS1E-SL2-DC48V       |
|                     | 3V DC                | DS2E-S-DC3V             | DS2E-SL2-DC3V        |
|                     | 5V DC                | DS2E-S-DC5V             | DS2E-SL2-DC5V        |
|                     | 6V DC                | DS2E-S-DC6V             | DS2E-SL2-DC6V        |
|                     | 9V DC                | DS2E-S-DC9V             | DS2E-SL2-DC9V        |
|                     | 12V DC               | DS2E-S-DC12V            | DS2E-SL2-DC12V       |
|                     | 24V DC               | DS2E-S-DC24V            | DS2E-SL2-DC24V       |
| 48V DC              | DS2E-S-DC48V         | DS2E-SL2-DC48V          |                      |

Standard packing: Carton: 50 pcs.; Case: 500 pcs.

## RATING

### 1. Coil data

#### 1) Single side stable type

| Type                      | Nominal coil voltage | Pick-up voltage (at 20°C 68°F)   | Drop-out voltage (at 20°C 68°F)           | Nominal operating current [ $\pm 10\%$ ] (at 20°C 68°F) | Coil resistance [ $\pm 10\%$ ] (at 20°C 68°F) | Nominal operating power | Max. applied voltage (at 50°C 122°F)   |
|---------------------------|----------------------|--|---|---|---|-------------------------|--|
| High sensitivity (S) type | 1.5V DC*             | 1 Form C:<br>80%V or less of nominal voltage<br>2 Form C:<br>70%V or less of nominal voltage (Initial) | 10%V or more of nominal voltage (Initial) | 133.3mA   | 11.3 $\Omega$                                 | 200mW                   | 1 Form C:<br>160%V of nominal voltage<br><br>2 Form C:<br>200%V of nominal voltage |
|                           | 3V DC                |  |   | 66.7mA  | 45 $\Omega$                                   |                         |  |
|                           | 5V DC                |  |   | 40.0mA  | 125 $\Omega$                                  |                         |  |
|                           | 6V DC                |  |   | 33.3mA  | 180 $\Omega$                                  |                         |  |
|                           | 9V DC                |  |   | 22.2mA  | 405 $\Omega$                                  |                         |  |
|                           | 12V DC               |  |   | 16.7mA  | 720 $\Omega$                                  |                         |  |
|                           | 24V DC               |  |   | 8.3mA   | 2,880 $\Omega$                                |                         |  |
| 48V DC                    | 4.2mA                | 11,520 $\Omega$  |   |   |   |                         |  |

#### 2) 2 coil latching type

| Type                      | Nominal coil voltage | Set voltage (at 20°C 68°F)                             | Reset voltage (at 20°C 68°F)                           | Nominal operating current [ $\pm 10\%$ ] (at 20°C 68°F) |            | Coil resistance [ $\pm 10\%$ ] (at 20°C 68°F) |                 | Nominal operating power |            | Max. applied voltage (at 50°C 122°F)   |
|---------------------------|----------------------|--|--|---|------------|---|-----------------|-------------------------|------------|--|
|                           |                      |  |  | Set coil  | Reset coil | Set coil                                      | Reset coil      | Set coil                | Reset coil |  |
| High sensitivity (S) type | 1.5V DC*             | 1 Form C:<br>80%V or less of nominal voltage           | 1 Form C:<br>80%V or less of nominal voltage           | 120mA   | 120mA      | 12.5 $\Omega$                                 | 12.5 $\Omega$   | 180mW                   | 180mW      | 1 Form C:<br>160%V of nominal voltage<br><br>2 Form C:<br>200%V of nominal voltage |
|                           | 3V DC                |  |  | 60mA  | 60mA       | 50 $\Omega$                                   | 50 $\Omega$     |                         |            |  |
|                           | 5V DC                |  |  | 36mA  | 36mA       | 139 $\Omega$                                  | 139 $\Omega$    |                         |            |  |
|                           | 6V DC                |  |  | 30mA  | 30mA       | 200 $\Omega$                                  | 200 $\Omega$    |                         |            |  |
|                           | 9V DC                | 2 Form C:<br>70%V or less of nominal voltage (Initial) | 2 Form C:<br>70%V or less of nominal voltage (Initial) | 20mA  | 20mA       | 450 $\Omega$                                  | 450 $\Omega$    |                         |            |  |
|                           | 12V DC               |  |  | 15mA  | 15mA       | 800 $\Omega$                                  | 800 $\Omega$    |                         |            |  |
|                           | 24V DC               |  |  | 7.5mA   | 7.5mA      | 3,200 $\Omega$                                | 3,200 $\Omega$  |                         |            |  |
|                           | 48V DC               |  |  | 3.75mA  | 3.75mA     | 12,800 $\Omega$                               | 12,800 $\Omega$ |                         |            |  |

\* Nominal coil voltage 1.5V type are 1 Form C only.

## 2. Specifications

| Characteristics            | Item  |                          | Specifications  |                           |
|----------------------------|---|--------------------------|---|---------------------------|
|                            |   |                          | 1 Form C  | 2 Form C                  |
| Contact                    | Arrangement                                       |                          | 1 Form C  | 2 Form C                  |
|                            | Initial contact resistance, max.                  |                          | Max. 50 mΩ (By voltage drop 6 V DC 1A)  |                           |
|                            | Contact material                                  |                          | Ag+Au clad  |                           |
| Rating                     | Nominal switching capacity                        |                          | 2 A 30 V DC (resistive load)  |                           |
|                            | Max. switching power                              |                          | 60 W, 125 VA (resistive load)   |                           |
|                            | Max. switching voltage                            |                          | 220 V DC, 250 V AC  |                           |
|                            | Max. carrying current                             |                          | 3 A   |                           |
|                            | Min. switching capacity (Reference value)*1       |                          | 10μA 10m V DC   |                           |
|                            | Nominal operating power                           |                          | Single side stable (S type: 200 mW); latching (S type: 180 mW)  |                           |
| Electrical characteristics | Insulation resistance (Initial)                   |                          | Min. 100MΩ (at 500V DC)<br>Measurement at same location as "Initial breakdown voltage" section.                                 |                           |
|                            | Breakdown voltage (Initial)                       | Between open contacts    | 1,000 Vrms for 1min.<br>(500 Vrms for 1min: 1 Form C type) (Detection current: 10mA.)   |                           |
|                            |   | Between contact and coil | 1,500 Vrms for 1min.<br>(1,000 Vrms for 1min: 1 Form C type) (Detection current: 10mA.)   |                           |
|                            | Temperature rise                                  |                          | Max. 65°C<br>(By resistive method, nominal coil voltage applied to the coil, contact carrying current: 2A.)                     |                           |
|                            | Operate time [Set time] (at 20°C 68°F)            |                          | Max. 10 ms [10 ms] (Nominal coil voltage applied to the coil, excluding contact bounce time.)                                   |                           |
|                            | Release time [Reset time] (at 20°C 68°F)          |                          | Max. 5 ms [10 ms] (Nominal coil voltage applied to the coil, excluding contact bounce time.)<br>(without diode)                 |                           |
| Mechanical characteristics | Shock resistance                                  | Functional*2             | Min. 490 m/s <sup>2</sup>   | Min. 490 m/s <sup>2</sup> |
|                            |   | Destructive              | Min. 980 m/s <sup>2</sup> (Half-wave pulse of sine wave: 6 ms.)   |                           |
|                            | Vibration resistance                              | Functional               | 10 to 55 Hz at double amplitude of 3.3 mm (Detection time: 10μs.)   |                           |
|                            |   | Destructive              | 10 to 55 Hz at double amplitude of 5 mm   |                           |
| Expected life              | Mechanical  |                          | Min. 10 <sup>8</sup> (10 <sup>7</sup> : 1 Form C latching type) (at 600 cpm)  |                           |
|                            | Electrical  |                          | Min. 5×10 <sup>5</sup> rated load (at 60 cpm)   |                           |
| Conditions                 | Conditions for operation, transport and storage*3 |                          | Ambient temperature: -40°C to +70°C -40°F to +158°F<br>Humidity: 5 to 85% R.H. (Not freezing and condensing at low temperature) |                           |
|                            | Max. operating speed (at rated load)              |                          | 60 cpm  |                           |
| Unit weight                |   |                          | Approx. 3 g .11 oz  | Approx. 4g .14oz          |

Notes: \*1 This value can change due to the switching frequency, environmental conditions, and desired reliability level, therefore it is recommended to check this with the actual load. (TX/TX-S/TX-D relay AgPd contact type are available for low level load switching [10V DC, 10mA max. level])

\*2 Half-wave pulse of sine wave: 11ms; detection time: 10μs

\*3 Refer to 6. Conditions for operation, transport and storage mentioned in AMBIENT ENVIRONMENT.

# REFERENCE DATA

## 1. Maximum switching capacity

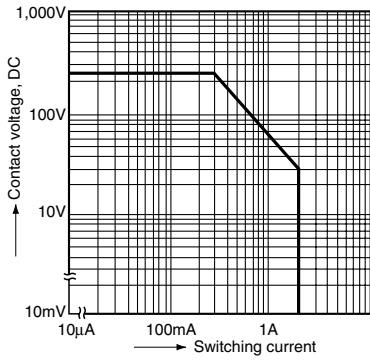

## 2. Life curve (Resistive load)

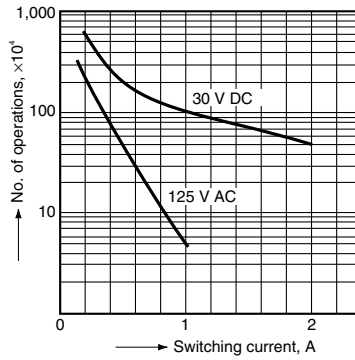

## 3. Contact reliability for AC loads

Tested sample: DS2E-S-DC24V 10 pcs.  
 Operating speed: 20 cpm.  
 Detection level: 200 mΩ

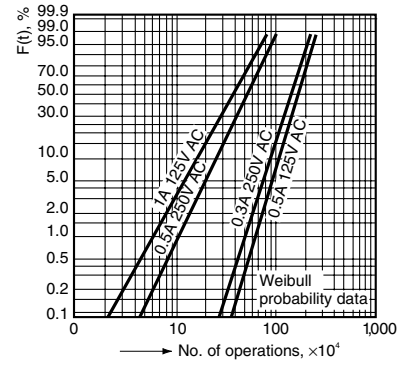

## 4. Operate and release time characteristics (2 Form C single side stable type)

Test condition: Without diode connected to coil in parallel

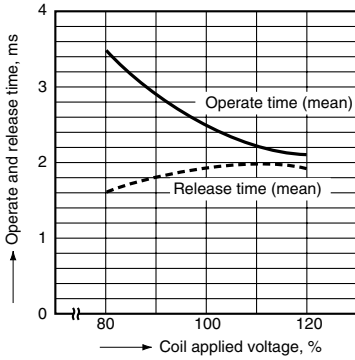

## 5-(1). Influence of adjacent mounting (1 Form C)

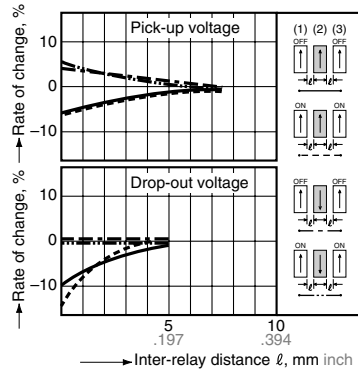

## 5-(2). Influence of adjacent mounting (2 Form C)

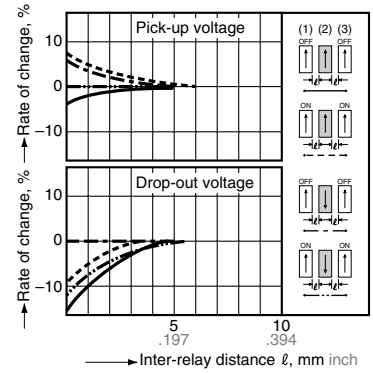

# DIMENSIONS (mm inch)

The CAD data of the products with a **CAD Data** mark can be downloaded from: <http://industrial.panasonic.com/ac/e/>

## DS (1 Form C)

Single side stable, 2 coil latching

**CAD Data**

External dimensions

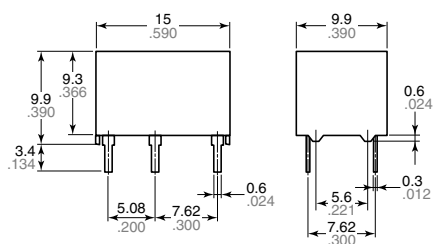

General tolerance:  $\pm 0.3 \pm 0.12$

PC board pattern (Bottom view)

Single side stable

2 coil latching

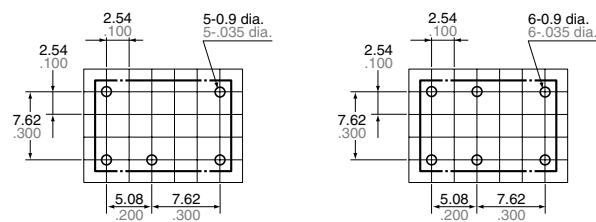

Schematic (Bottom view)

Single side stable

2 coil latching



(Deenergized condition)

(Reset condition)

Tolerance:  $\pm 0.1 \pm 0.04$

Note: External dimensions of 1 coil latching types are same as single side stable type.

## DS (2 Form C)

Single side stable

**CAD Data**

External dimensions

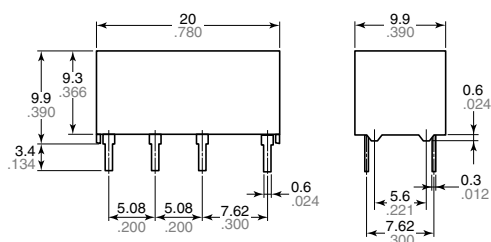

General tolerance:  $\pm 0.3 \pm 0.12$

PC board pattern (Bottom view)

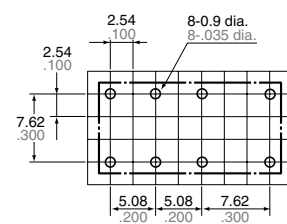

Schematic (Bottom view)

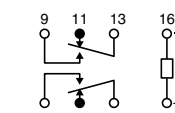

(Deenergized condition)

Tolerance:  $\pm 0.1 \pm 0.04$

Note: External dimensions of 1 coil latching types are same as single side stable type.

## DS (2 Form C)

2 coil latching

**CAD Data**

External dimensions

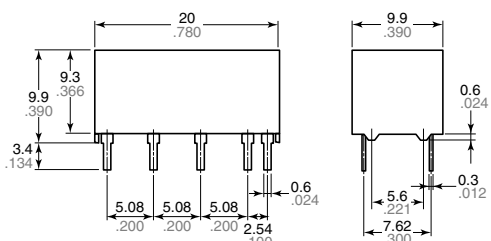

General tolerance:  $\pm 0.3 \pm 0.12$

PC board pattern (Bottom view)

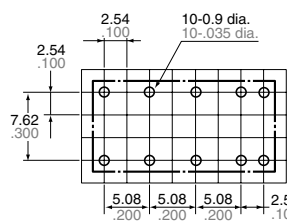

Schematic (Bottom view)

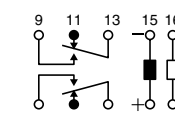

(Reset condition)

Tolerance:  $\pm 0.1 \pm 0.04$

## NOTES

### 1. Coil connection

When connecting coils, refer to the wiring diagram to prevent mis-operation or malfunction.

**For general cautions for use, please refer to the “Cautions for use of Signal Relays” or “General Application Guidelines”.**

# Mouser Electronics

Authorized Distributor

Click to View Pricing, Inventory, Delivery & Lifecycle Information:

## Panasonic:

[DS2E-ML2-DC12V](#) [DS2E-ML2-DC24V](#) [DS2E-ML2-DC5V](#) [DS2E-ML2-DC9V](#) [DS1E-ML2-DC1.5V](#) [DS1E-ML2-DC3V](#)  
[DS1E-ML2-DC48V](#) [DS1E-ML2-DC9V](#) [DS2E-ML2-DC1.5V](#) [DS2E-ML2-DC48V](#) [DS2E-ML2-DC6V](#) [DS1E-ML2-DC12V](#)  
[DS1E-ML2-DC5V](#) [DS1E-ML-DC12V](#) [DS1E-ML2-DC24V](#) [DS1E-ML2-DC6V](#) [DS2E-ML2-DC3V](#) [DS1E-ML2-DC24V-R](#)  
[DS1E-ML2-DC3V-R](#) [DS1E-ML2-DC5V-R](#) [DS1E-ML-DC1.5V](#) [DS1E-ML-DC24V](#) [DS1E-ML-DC48V](#) [DS1E-ML-DC5V](#)  
[DS1E-ML-DC6V](#) [DS1E-ML-DC9V](#) [DS2E-ML2-DC12V-R](#) [DS2E-ML2-DC5V-R](#) [DS2E-ML2-DC5V-TB](#) [DS2E-ML-DC12V](#)  
[DS2E-ML-DC24V](#) [DS2E-ML-DC5V](#) [DS2E-ML-DC6V](#)



Компания «ЭлектроПласт» предлагает заключение долгосрочных отношений при поставках импортных электронных компонентов на взаимовыгодных условиях!

Наши преимущества:

- Оперативные поставки широкого спектра электронных компонентов отечественного и импортного производства напрямую от производителей и с крупнейших мировых складов;
- Поставка более 17-ти миллионов наименований электронных компонентов;
- Поставка сложных, дефицитных, либо снятых с производства позиций;
- Оперативные сроки поставки под заказ (от 5 рабочих дней);
- Экспресс доставка в любую точку России;
- Техническая поддержка проекта, помощь в подборе аналогов, поставка прототипов;
- Система менеджмента качества сертифицирована по Международному стандарту ISO 9001;
- Лицензия ФСБ на осуществление работ с использованием сведений, составляющих государственную тайну;
- Поставка специализированных компонентов (Xilinx, Altera, Analog Devices, Intersil, Interpoint, Microsemi, Aeroflex, Peregrine, Syfer, Eurofarad, Texas Instrument, Miteq, Cobham, E2V, MA-COM, Hittite, Mini-Circuits, General Dynamics и др.);

Помимо этого, одним из направлений компании «ЭлектроПласт» является направление «Источники питания». Мы предлагаем Вам помощь Конструкторского отдела:

- Подбор оптимального решения, техническое обоснование при выборе компонента;
- Подбор аналогов;
- Консультации по применению компонента;
- Поставка образцов и прототипов;
- Техническая поддержка проекта;
- Защита от снятия компонента с производства.



#### Как с нами связаться

**Телефон:** 8 (812) 309 58 32 (многоканальный)

**Факс:** 8 (812) 320-02-42

**Электронная почта:** [org@eplast1.ru](mailto:org@eplast1.ru)

**Адрес:** 198099, г. Санкт-Петербург, ул. Калинина, дом 2, корпус 4, литера А.