

## Austin MegaLynx™: Non-Isolated DC-DC Power Modules

4.5Vdc – 5.5Vdc input; 0.8Vdc to 3.63Vdc output; 30A Output Current

6Vdc – 14Vdc input; 0.8Vdc to 3.63Vdc output; 20/30A Output Current

### RoHS Compliant



### Applications

- Distributed power architectures
- Intermediate bus voltage applications
- Telecommunications equipment
- Servers and storage applications
- Networking equipment

### Features

- Compliant to RoHS EU Directive 2011/65/EU (-Z versions)
- Compliant to RoHS EU Directive 2011/65/EU under exemption 7b (Lead solder exemption). Exemption 7b will expire after June 1, 2016 at which time this product will no longer be RoHS compliant (non-Z versions)
- Delivers up to 30A of output current
- High efficiency: 92% @ 3.3V full load (12Vin)
- Available in two input voltage ranges  
ATH: 4.5 to 5.5Vdc  
ATS: 6 to 14Vdc
- Output voltage programmable from  
ATH: 0.8 to 3.63Vdc  
ATS030: 0.8 to 2.75Vdc  
ATS020: 0.8 to 3.63Vdc
- Small size and low profile:  
33.0 mm x 10.0 mm x 13.5 mm  
(1.30 in. x 0.39 in. x 0.53 in.)
- Monotonic start-up into pre-biased output
- Output voltage sequencing (EZ-SEQUENCE™)
- Remote On/Off
- Remote Sense
- Over current and Over temperature protection
- -P option: Paralleling with active current share
- -H option: Additional GND pins for improved thermal derating
- Wide operating temperature range (-40°C to 85°C)
- UL\* 60950 Recognized, CSA† C22.2 No. 60950-00 Certified, and VDE‡ 0805 (EN60950-1 3<sup>rd</sup> edition) Licensed
- ISO\*\* 9001 and ISO 14001 certified manufacturing facilities

### Description

The Austin MegaLynx series SMT power modules are non-isolated DC-DC converters in an industry standard package that can deliver up to 30A of output current with a full load efficiency of 92% at 2.5Vdc output voltage ( $V_{IN} = 12Vdc$ ). The ATH series of modules operate off an input voltage from 4.5 to 5.5Vdc and provide an output voltage that is programmable from 0.8 to 3.63Vdc, while the ATS series of modules have an input voltage range from 6 to 14V and provide a programmable output voltage ranging from 0.8 to 3.63Vdc. Both series have a sequencing feature that enables designers to implement various types of output voltage sequencing when powering multiple modules on the board. Additional features include remote On/Off, adjustable output voltage, remote sense, over current, over temperature protection and active current sharing between modules.

\* UL is a registered trademark of Underwriters Laboratories, Inc.

† CSA is a registered trademark of Canadian Standards Association.

‡ VDE is a trademark of Verband Deutscher Elektrotechniker e.V.

\*\* ISO is a registered trademark of the International Organization of Standards

## Austin MegaLynx™: Non-Isolated DC-DC Power Modules

4.5Vdc – 5.5Vdc input; 0.8Vdc to 3.63Vdc output; 30A Output Current

6Vdc – 14Vdc input; 0.8Vdc to 3.63Vdc output; 20/30A Output Current

### Absolute Maximum Ratings

Stresses in excess of the absolute maximum ratings can cause permanent damage to the device. These are absolute stress ratings only, functional operation of the device is not implied at these or any other conditions in excess of those given in the operations sections of the data sheet. Exposure to absolute maximum ratings for extended periods can adversely affect the device reliability.

| Parameter   | Device | Symbol    | Min  | Max | Unit |
|---|--------|-----------|------|-----|------|
| Input Voltage<br>Continuous   | ATH    | $V_{IN}$  | -0.3 | 6   | Vdc  |
|   | ATS    | $V_{IN}$  | -0.3 | 15  | Vdc  |
| Sequencing pin voltage  | ATH    | $V_{SEQ}$ | -0.3 | 6   | Vdc  |
|   | ATS    | $V_{SEQ}$ | -0.3 | 15  | Vdc  |
| Operating Ambient Temperature<br>(see Thermal Considerations section) | All    | $T_A$     | -40  | 85  | °C   |
| Storage Temperature   | All    | $T_{stg}$ | -55  | 125 | °C   |

### Electrical Specifications

Unless otherwise indicated, specifications apply over all operating input voltage, resistive load, and temperature conditions.

| Parameter  | Device | Symbol       | Min | Typ | Max  | Unit             |
|--|--------|--------------|-----|-----|------|------------------|
| Operating Input Voltage  | ATH    | $V_{IN}$     | 4.5 | 5.0 | 5.5  | Vdc              |
|  | ATS    | $V_{IN}$     | 6.0 | 12  | 14   | Vdc              |
| Maximum Input Current<br>( $V_{IN}=V_{IN,min}$ , $V_O=V_{O,set}$ , $I_O=I_{O,max}$ )   | ATH    | $I_{IN,max}$ |     |     | 27   | Adc              |
|  | ATS020 | $I_{IN,max}$ |     |     | 13.3 | Adc              |
|  | ATS030 | $I_{IN,max}$ |     |     | 15.8 | Adc              |
| Inrush Transient   | All    | $I^2 t$      |     |     | 1    | A <sup>2</sup> s |
| Input Reflected Ripple Current, peak-to-peak<br>(5Hz to 20MHz, 1 $\mu$ H source impedance; $V_{IN}=6.0V$ to 14.0V, $I_O=I_{O,max}$ ; See Figure 1) | All    |              |     | 100 |      | mAp-p            |
| Input Ripple Rejection (120Hz)   | All    |              |     | 50  |      | dB               |

## Austin MegaLynx™: Non-Isolated DC-DC Power Modules

4.5Vdc – 5.5Vdc input; 0.8Vdc to 3.63Vdc output; 30A Output Current

6Vdc – 14Vdc input; 0.8Vdc to 3.63Vdc output; 20/30A Output Current

### Electrical Specifications (continued)

| Parameter  | Device  | Symbol   | Min               | Typ  | Max                  | Unit   |
|--|---|--|-------------------|--|----------------------|--|
| Output Voltage Set-point<br>( $V_{IN}=V_{IN,nom}$ , $I_o=I_{o,nom}$ , $T_{ref}=25^{\circ}C$ )  | All   | $V_{O,set}$  | -1.5              | —  | +1.5                 | % $V_{O,set}$                                |
| Output Voltage<br>(Over all operating input voltage, resistive load, and temperature conditions until end of life)   | All   | $V_{O,set}$  | -5.0              | —  | +3.0                 | % $V_{O,set}$                                |
| Adjustment Range<br>Selected by an external resistor   | ATS030<br>ATS020<br>ATH030*   |  | 0.8<br>0.8<br>0.8 |  | 2.75<br>3.63<br>3.63 | Vdc<br>Vdc<br>Vdc                            |
| * $V_o \geq 3.3V$ only possible for $V_{IN} \geq 4.75V$  |   |  |                   |  |                      |  |
| Output Regulation<br>Line ( $V_{IN}=V_{IN,min}$ to $V_{IN,max}$ )<br>Load ( $I_o=I_{o,min}$ to $I_{o,max}$ )<br>Temperature ( $T_{ref}=T_{A,min}$ to $T_{A,max}$ )   | All<br>All<br>(-P version)<br>All   |  | —<br>—<br>—<br>—  | —<br>—<br>—<br>0.5                           | 20<br>40<br>70<br>1  | mV<br>mV<br>mV<br>% $V_{O,set}$              |
| Output Ripple and Noise on nominal output<br>( $V_{IN}=V_{IN,nom}$ and $I_o=I_{o,min}$ to $I_{o,max}$<br>$C_{OUT} = 0.1\mu F // 10 \mu F$ ceramic capacitors)<br>Peak-to-Peak (5Hz to 20MHz bandwidth)<br>Peak-to-Peak (5Hz to 20MHz bandwidth)<br>Peak-to-Peak (5Hz to 20MHz bandwidth) | <br><br>$V_o \leq 2.5V$<br>$2.5V < V_o \leq 3.63V$<br>$V_o > 3.63V$   |  | —<br>—<br>—       |  | 50<br>75<br>100      | $mV_{pk-pk}$<br>$mV_{pk-pk}$<br>$mV_{pk-pk}$ |
| External Capacitance <sup>1</sup><br>ESR $\geq 1 m\Omega$<br>ESR $\geq 10 m\Omega$   | All<br>All  | $C_{O,max}$<br>$C_{O,max}$                               | 0<br>0            | —<br>—                                       | 2,000<br>10,000      | $\mu F$<br>$\mu F$                           |
| Output Current<br>( $V_{IN} = 4.5$ to $5.5Vdc$ )<br>( $V_{IN} = 6$ to $14Vdc$ )<br>( $V_{IN} = 6$ to $14Vdc$ )   | ATH Series<br>ATS030 Series<br>ATS020 Series  | $I_o$<br>$I_o$<br>$I_o$                                  | 0<br>0<br>0       |  | 30<br>30<br>20       | Adc<br>Adc<br>Adc                            |
| Output Current Limit Inception (Hiccup Mode)   | All   | $I_{o,lim}$  | —                 | 140  | —                    | % $I_{o,max}$                                |
| Output Short-Circuit Current<br>( $V_o \leq 250mV$ ) ( Hiccup Mode )   | All   | $I_{o,s/c}$  | —                 | 3.5  | —                    | Adc  |
| Efficiency<br>ATH Series: $V_{IN}=5Vdc$ , $T_A=25^{\circ}C$<br>$I_o=I_{o,max}$ , $V_o=V_{O,set}$   | $V_{O,set} = 0.8dc$<br>$V_{O,set} = 1.2Vdc$<br>$V_{O,set} = 1.5Vdc$<br>$V_{O,set} = 1.8Vdc$<br>$V_{O,set} = 2.5Vdc$<br>$V_{O,set} = 3.3Vdc$ | $\eta$<br>$\eta$<br>$\eta$<br>$\eta$<br>$\eta$<br>$\eta$ |                   | 82.2<br>85.8<br>89.5<br>89.2<br>92.0<br>92.2 |                      | %<br>%<br>%<br>%<br>%<br>%                   |

<sup>1</sup> Note that maximum external capacitance may be lower when sequencing is employed. Please check with your GE Technical representative.

## Austin MegaLynx™: Non-Isolated DC-DC Power Modules

4.5Vdc – 5.5Vdc input; 0.8Vdc to 3.63Vdc output; 30A Output Current

6Vdc – 14Vdc input; 0.8Vdc to 3.63Vdc output; 20/30A Output Current

### Electrical Specifications (continued)

| Parameter   | Device               | Symbol   | Min | Typ  | Max | Unit    |
|---|----------------------|----------|-----|------|-----|---------|
| ATS Series: $V_{IN}=12Vdc$ , $T_A=25^\circ C$<br>$I_o=I_{o,max}$ , $V_o=V_{o,set}$              | $V_{o,set} = 0.8Vdc$ | $\eta$   |     | 77.5 |     | %       |
|   | $V_{o,set} = 1.2Vdc$ | $\eta$   |     | 83.5 |     | %       |
|   | $V_{o,set} = 1.8Vdc$ | $\eta$   |     | 86.5 |     | %       |
|   | $V_{o,set} = 2.5Vdc$ | $\eta$   |     | 91.3 |     | %       |
|   | $V_{o,set} = 3.3Vdc$ | $\eta$   |     | 92.1 |     | %       |
| Switching Frequency, Fixed  | All                  | $f_{sw}$ | —   | 300  | —   | kHz     |
| Dynamic Load Response<br>( $dI_o/dt=5A/\mu s$ ; $V_{IN}=12V$ , $V_o=3.3V$ ; $T_A=25^\circ C$ )  |                      |          |     |      |     |         |
| Load Change from $I_o= 50\%$ to $100\%$ of $I_{o,max}$ ; No external output capacitors          |                      |          |     |      |     |         |
| Peak Deviation  | All                  | $V_{pk}$ | —   | 350  |     | mV      |
| Settling Time ( $V_o<10\%$ peak deviation)  | All                  | $t_s$    | —   | 25   | —   | $\mu s$ |
| ( $dI_o/dt=5A/\mu s$ ; $V_{IN}=V_{IN, nom}$ ; $T_A=25^\circ C$ )                                |                      |          |     |      |     |         |
| Load Change from $I_o= 100\%$ to $50\%$ of $I_{o,max}$ ; No external output capacitors          |                      |          |     |      |     |         |
| Peak Deviation  | All                  | $V_{pk}$ | —   | 350  |     | mV      |
| Settling Time ( $V_o<10\%$ peak deviation)  | All                  | $t_s$    | —   | 25   | —   | $\mu s$ |
| ( $dI_o/dt=5A/\mu s$ ; $V_{IN}=V_{IN, nom}$ ; $T_A=25^\circ C$ )                                |                      |          |     |      |     |         |
| Load Change from $I_o= 50\%$ to $100\%$ of $I_{o,max}$ ; $2 \times 150 \mu F$ polymer capacitor |                      |          |     |      |     |         |
| Peak Deviation  | All                  | $V_{pk}$ | —   | 250  | —   | mV      |
| Settling Time ( $V_o<10\%$ peak deviation)  | All                  | $t_s$    | —   | 40   | —   | $\mu s$ |
| ( $dI_o/dt=5A/\mu s$ ; $V_{IN}=V_{IN, nom}$ ; $T_A=25^\circ C$ )                                |                      |          |     |      |     |         |
| Load Change from $I_o= 100\%$ to $50\%$ of $I_{o,max}$ ; $2 \times 150 \mu F$ polymer capacitor |                      |          |     |      |     |         |
| Peak Deviation  | All                  | $V_{pk}$ | —   | 250  | —   | mV      |
| Settling Time ( $V_o<10\%$ peak deviation)  | All                  | $t_s$    | —   | 40   | —   | $\mu s$ |

### General Specifications

| Parameter  | Min | Typ        | Max | Unit    |
|--|-----|------------|-----|---------|
| Calculated MTBF ( $V_{IN}=12V$ , $V_o=3.3Vdc$ , $I_o= 0.8I_{o,max}$ , $T_A=40^\circ C$ ) Per Telecordia Method |     | 3,016,040  |     | Hours   |
| Weight   | —   | 6.2 (0.22) | —   | g (oz.) |

## Austin MegaLynx™: Non-Isolated DC-DC Power Modules

4.5Vdc – 5.5Vdc input; 0.8Vdc to 3.63Vdc output; 30A Output Current

6Vdc – 14Vdc input; 0.8Vdc to 3.63Vdc output; 20/30A Output Current

### Feature Specifications

Unless otherwise indicated, specifications apply over all operating input voltage, resistive load, and temperature conditions. See Feature Descriptions for additional information.

| Parameter   | Device | Symbol          | Min  | Typ | Max          | Unit             |
|---|--------|-----------------|------|-----|--------------|------------------|
| On/Off Signal Interface<br>( $V_{IN}=V_{IN,min}$ to $V_{IN,max}$ ; open collector or equivalent,<br>Signal referenced to GND)   |        |                 |      |     |              |                  |
| Logic High (Module OFF)   |        |                 |      |     |              |                  |
| Input High Current  | All    | $I_{IH}$        | 0.5  | —   | 3.3          | mA               |
| Input High Voltage  | All    | $V_{IH}$        | 3.0  | —   | $V_{IN,max}$ | V                |
| Logic Low (Module ON)   |        |                 |      |     |              |                  |
| Input Low Current   | All    | $I_{IL}$        | —    | —   | 200          | $\mu$ A          |
| Input Low Voltage   | All    | $V_{IL}$        | -0.3 | —   | 1.2          | V                |
| Turn-On Delay and Rise Times<br><br>( $V_{IN}=V_{IN,nom}$ , $I_o=I_{o,max}$ , $V_o$ to within $\pm 1\%$ of steady state)  |        |                 |      |     |              |                  |
| Case 1: On/Off input is enabled and then<br>input power is applied (delay from instant at<br>which $V_{IN} = V_{IN,min}$ until $V_o = 10\%$ of $V_{o,set}$ )                                  | All    | $T_{delay}$     | —    | 2.5 | 5            | msec             |
| Case 2: Input power is applied for at least one<br>second and then the On/Off input is enabled<br>(delay from instant at which $V_{on/Off}$ is enabled<br>until $V_o = 10\%$ of $V_{o,set}$ ) | All    | $T_{delay}$     | —    | 2.5 | 5            | msec             |
| Output voltage Rise time (time for $V_o$ to rise from<br>10% of $V_{o,set}$ to 90% of $V_{o,set}$ )   | All    | $T_{rise}$      | 2    | —   | 10           | msec             |
| Output voltage overshoot<br>$I_o = I_{o,max}$ ; $V_{IN,min} - V_{IN,max}$ , $T_A = 25^\circ\text{C}$  |        |                 |      |     | 3.0          | % $V_{o,set}$    |
| Remote Sense Range  | All    |                 | —    | —   | 0.5          | V                |
| Over temperature Protection<br>(See Thermal Consideration section)  | All    | $T_{ref}$       | —    | 125 | —            | $^\circ\text{C}$ |
| Sequencing Slew rate capability<br>( $V_{IN,min}$ to $V_{IN,max}$ ; $I_{o,min}$ to $I_{o,max}$ $V_{SEQ} < V_o$ )  | All    | $dV_{SEQ}/dt$   |      | —   | 2            | V/msec           |
| Sequencing Delay time (Delay from $V_{IN,min}$<br>to application of voltage on SEQ pin)   | All    | $T_{SEQ-delay}$ | 10   |     |              | msec             |
| Tracking Accuracy   |        |                 |      |     |              |                  |
| Power-up (2V/ms)  | All    | $V_{SEQ} - V_o$ |      | 100 | 200          | mV               |
| Power-down (1V/ms)  |        | $V_{SEQ} - V_o$ |      | 200 | 400          | mV               |
|   |        |                 |      |     |              |                  |
|   |        |                 |      |     |              |                  |
|   |        |                 |      |     |              |                  |
|   |        |                 |      |     |              |                  |
| Input Undervoltage Lockout  |        |                 |      |     |              |                  |
| Turn-on Threshold   | ATH    |                 |      | 4.3 |              | Vdc              |
| Turn-off Threshold  | ATH    |                 |      | 3.9 |              | Vdc              |
| Turn-on Threshold   | ATS    |                 |      | 5.5 |              | Vdc              |
| Turn-off Threshold  | ATS    |                 |      | 5.0 |              | Vdc              |
| Forced Load Share Accuracy  | -P     |                 | —    | 10  |              | % $I_o$          |
| Number of units in Parallel   | -P     |                 |      |     | 5            |                  |

# Austin MegaLynx™: Non-Isolated DC-DC Power Modules

4.5Vdc – 5.5Vdc input; 0.8Vdc to 3.63Vdc output; 30A Output Current

6Vdc – 14Vdc input; 0.8Vdc to 3.63Vdc output; 20/30A Output Current

## Characteristic Curves

The following figures provide typical characteristics for the ATS030A0X3-SR & -SRH (0.8V, 30A) at 25°C.

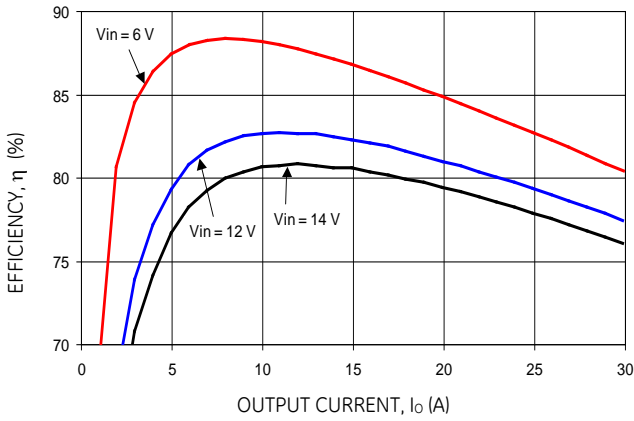

Figure 1. Converter Efficiency versus Output Current.

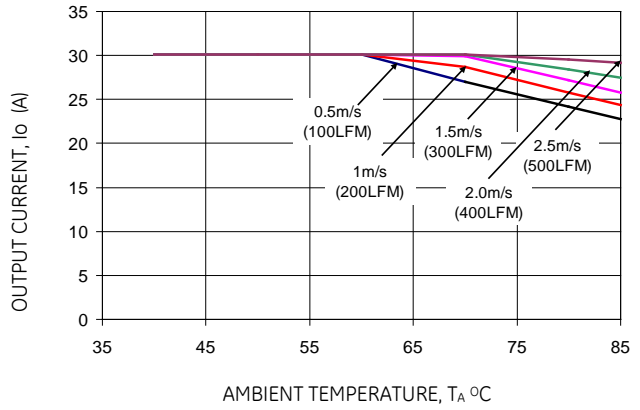

Figure 4. Derating Output Current versus Ambient Temperature and Airflow (ATS030A0X3-SRH).

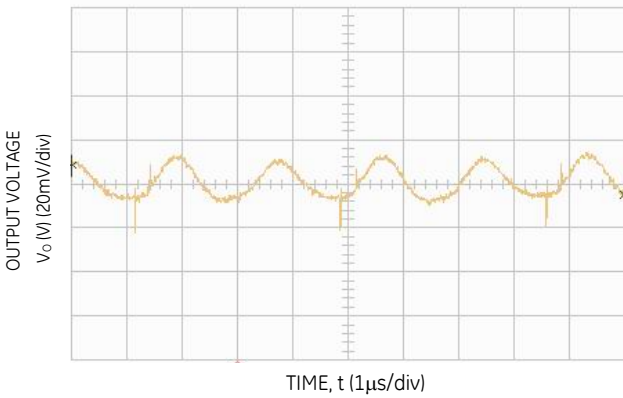

Figure 2. Typical output ripple and noise ( $V_{IN} = V_{IN,NOM}$ ,  $I_o = I_{o,max}$ ).

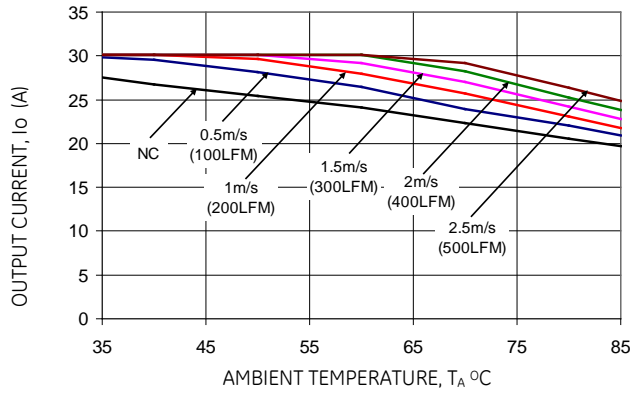

Figure 5. Derating Output Current versus Ambient Temperature and Airflow (ATS030A0X3-SR).

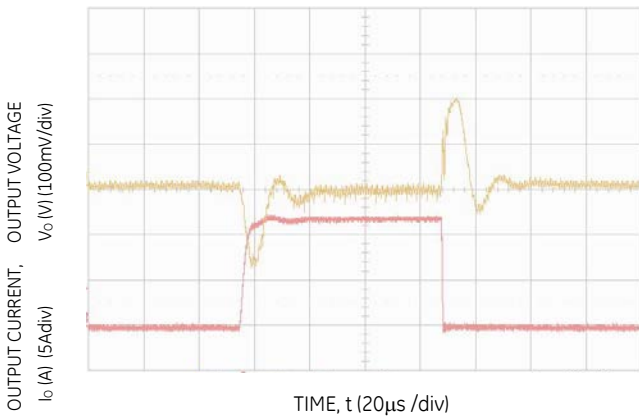

Figure 3. Transient Response to Dynamic Load Change from 0% to 50% to 0% of full load with  $V_{IN} = 12V$ .

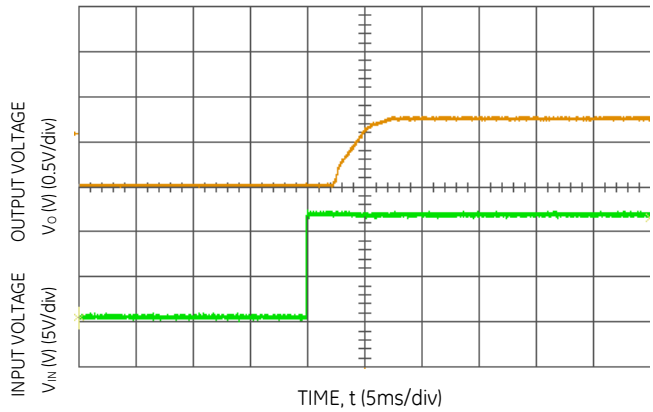

Figure 6. Typical Start-up Using Input Voltage ( $V_{IN} = V_{IN,NOM}$ ,  $I_o = I_{o,max}$ ).

## Austin MegaLynx™: Non-Isolated DC-DC Power Modules

4.5Vdc – 5.5Vdc input; 0.8Vdc to 3.63Vdc output; 30A Output Current

6Vdc – 14Vdc input; 0.8Vdc to 3.63Vdc output; 20/30A Output Current

### Characteristic Curves

The following figures provide typical characteristics for the ATS030A0X3-SR and -SRH (1.25V, 30A) at 25°C.

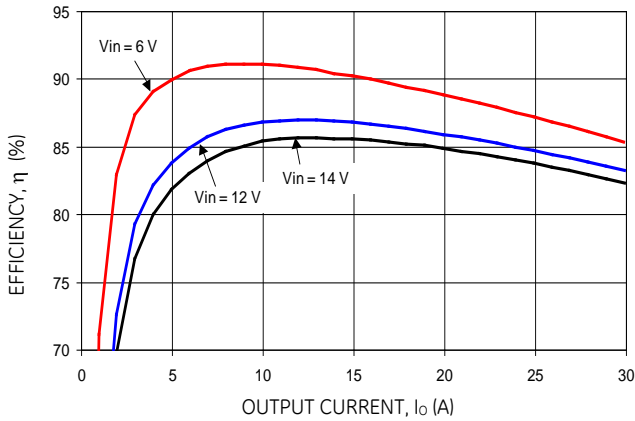

Figure 7. Converter Efficiency versus Output Current.

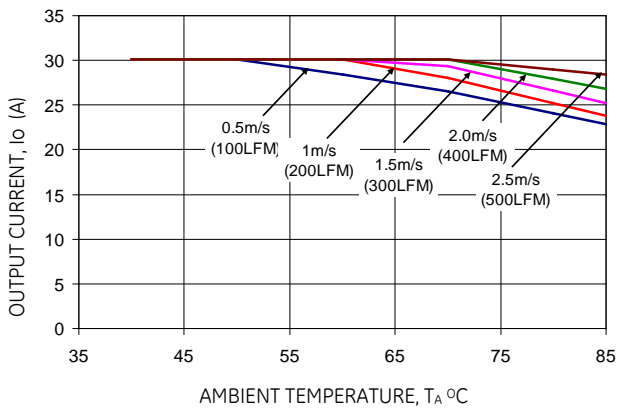

Figure 8. Derating Output Current versus Ambient Temperature and Airflow (ATS030A0X3-SRH).

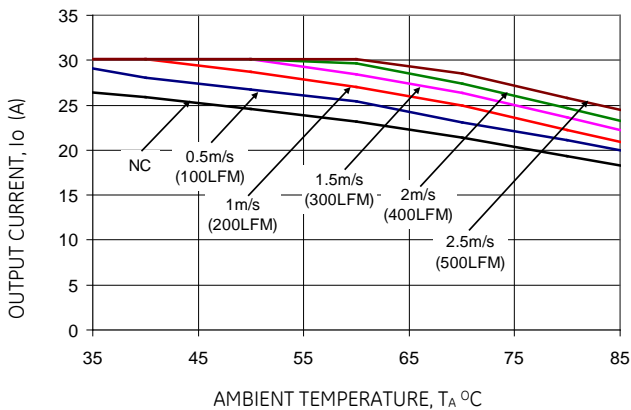

Figure 9. Derating Output Current versus Ambient Temperature and Airflow (ATS030A0X3-SR).

# Austin MegaLynx™: Non-Isolated DC-DC Power Modules

4.5Vdc – 5.5Vdc input; 0.8Vdc to 3.63Vdc output; 30A Output Current

6Vdc – 14Vdc input; 0.8Vdc to 3.63Vdc output; 20/30A Output Current

## Characteristic Curves

The following figures provide typical characteristics for the ATS030A0X3-SR and -SRH (1.8V, 30A) at 25°C.

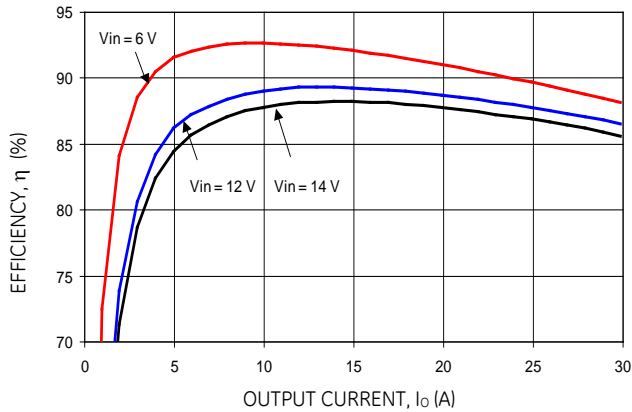

Figure 10. Converter Efficiency versus Output Current.

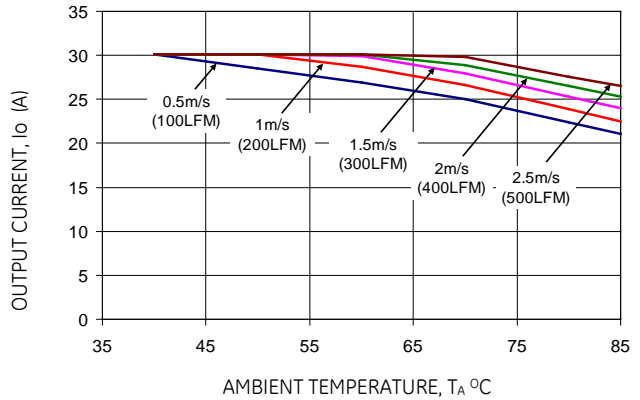

Figure 13. Output Current Derating versus Ambient Temperature and Airflow (ATS030A0X3-SRH).

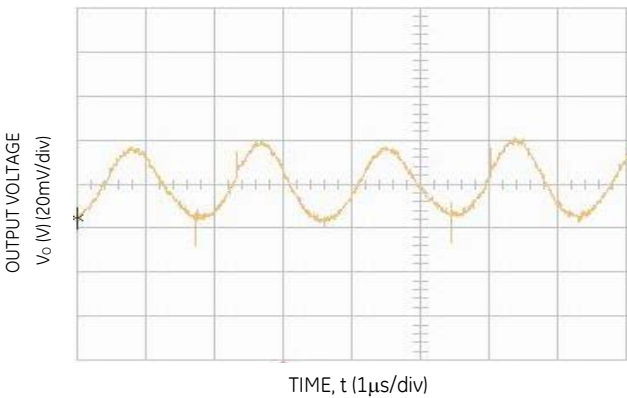

Figure 11. Typical output ripple and noise ( $V_{IN} = V_{IN,NOM}$ ,  $I_o = I_{o,max}$ ).

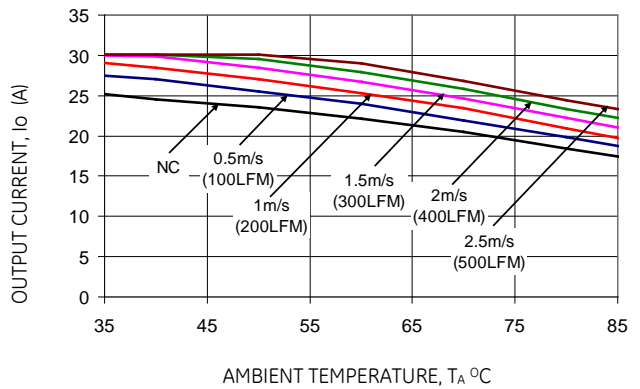

Figure 14. Output Current Derating versus Ambient Temperature and Airflow (ATS030A0X3-SR).

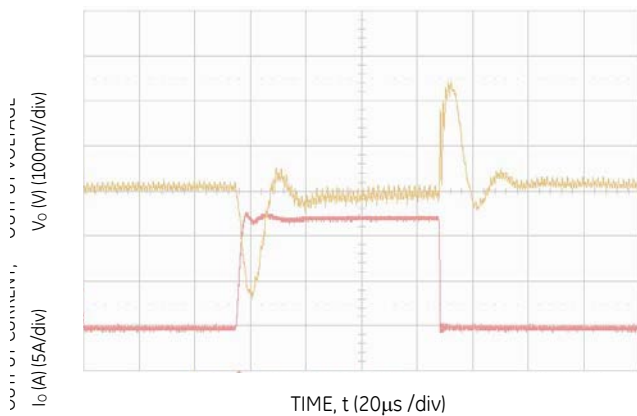

Figure 12. Transient Response to Dynamic Load Change from 0% to 50% to 0% of full load with  $V_{IN} = 12V$ .

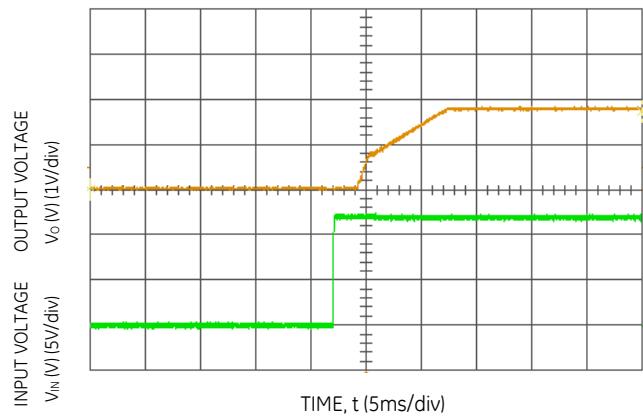

Figure 15. Typical Start-up Using Input Voltage ( $V_{IN} = V_{IN,NOM}$ ,  $I_o = I_{o,max}$ ).



## Austin MegaLynx™: Non-Isolated DC-DC Power Modules

4.5Vdc – 5.5Vdc input; 0.8Vdc to 3.63Vdc output; 30A Output Current

6Vdc – 14Vdc input; 0.8Vdc to 3.63Vdc output; 20/30A Output Current

### Characteristic Curves

The following figures provide typical characteristics for the ATS030A0X3-SR and -SRH (2.5V, 30A) at 25°C.

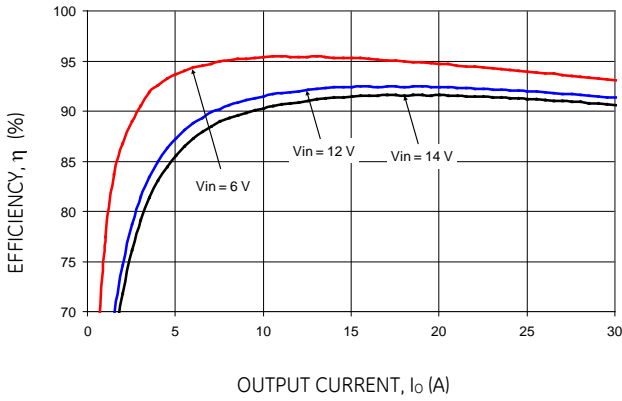

Figure 16. Converter Efficiency versus Output Current.

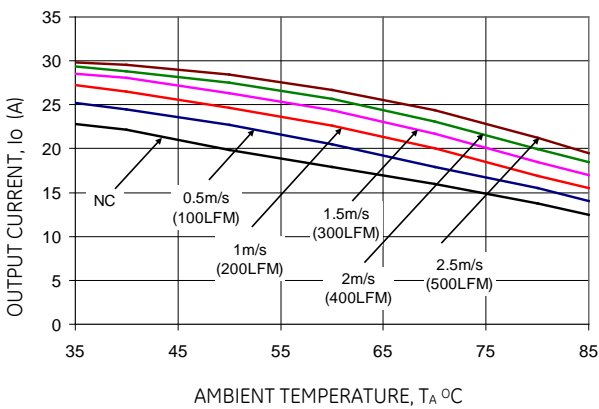

Figure 17. Derating Output Current versus Ambient Temperature and Airflow (ATS030A0X3-SRH).

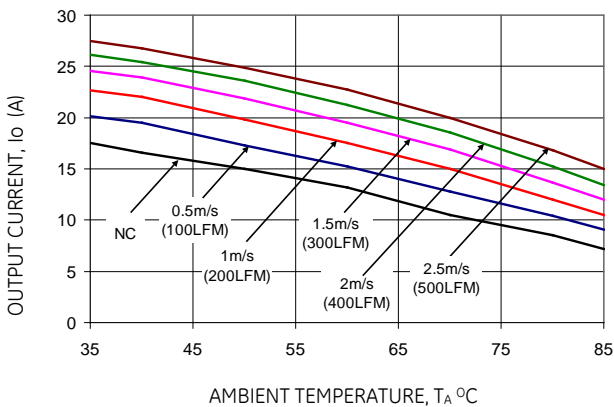

Figure 18. Derating Output Current versus Ambient Temperature and Airflow (ATS030A0X3-SR).

# Austin MegaLynx™: Non-Isolated DC-DC Power Modules

4.5Vdc – 5.5Vdc input; 0.8Vdc to 3.63Vdc output; 30A Output Current

6Vdc – 14Vdc input; 0.8Vdc to 3.63Vdc output; 20/30A Output Current

## Characteristic Curves

The following figures provide typical characteristics for the ATS020A0X3-SR and -SRH (3.3V, 20A) at 25°C.

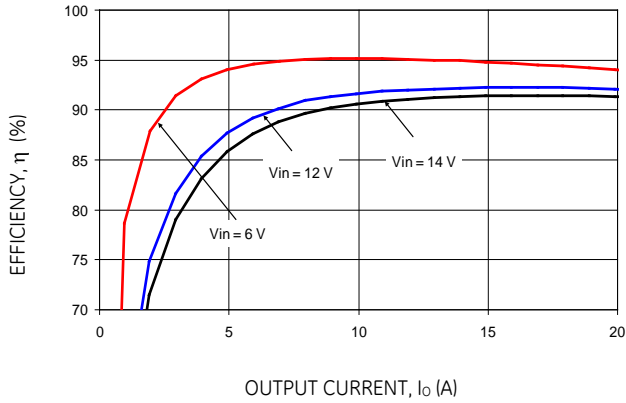

Figure 19. Converter Efficiency versus Output Current.

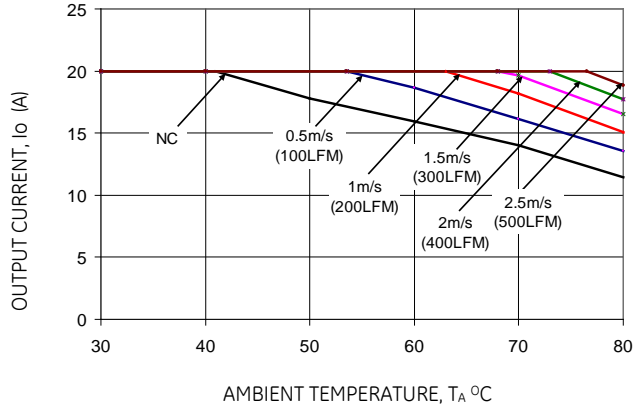

Figure 22. Output Current Derating versus Ambient Temperature and Airflow (ATS020A0X3-SRH).

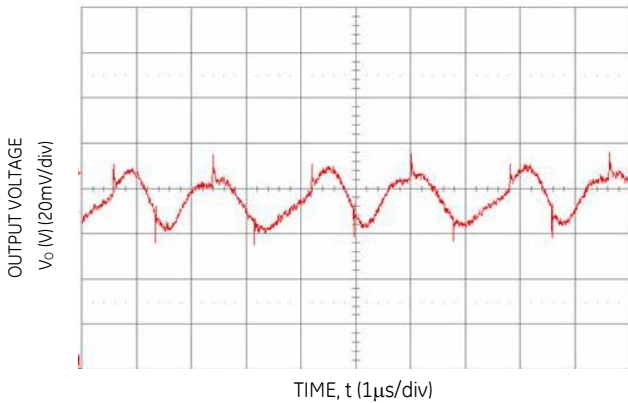

Figure 20. Typical output ripple and noise ( $V_{IN} = V_{IN,NOM}$ ,  $I_o = I_{o,max}$ ).

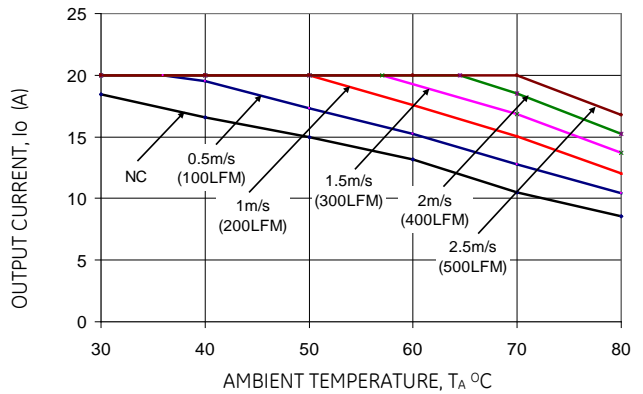

Figure 23. Output Current Derating versus Ambient Temperature and Airflow (ATS020A0X3-SR).

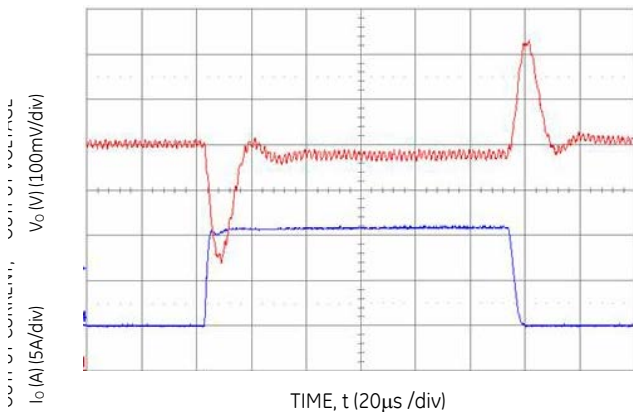

Figure 21. Transient Response to Dynamic Load Change from 0% to 50% of full load with  $V_{IN} = 12V$ .

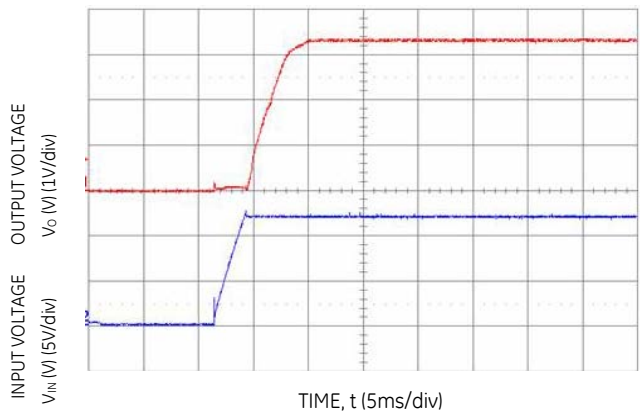

Figure 24. Typical Start-up Using Input Voltage ( $V_{IN} = V_{IN,NOM}$ ,  $I_o = I_{o,max}$ ).

# Austin MegaLynx™: Non-Isolated DC-DC Power Modules

4.5Vdc – 5.5Vdc input; 0.8Vdc to 3.63Vdc output; 30A Output Current

6Vdc – 14Vdc input; 0.8Vdc to 3.63Vdc output; 20/30A Output Current

## Characteristic Curves

The following figures provide typical characteristics for the ATH030A0X3-SR and -SRH (0.8V, 30A) at 25°C.

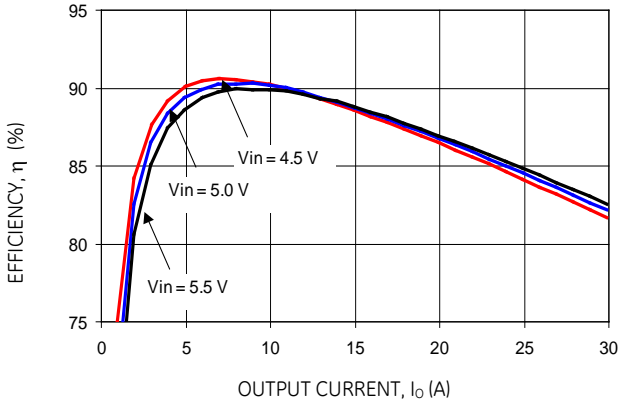

Figure 25. Converter Efficiency versus Output Current.

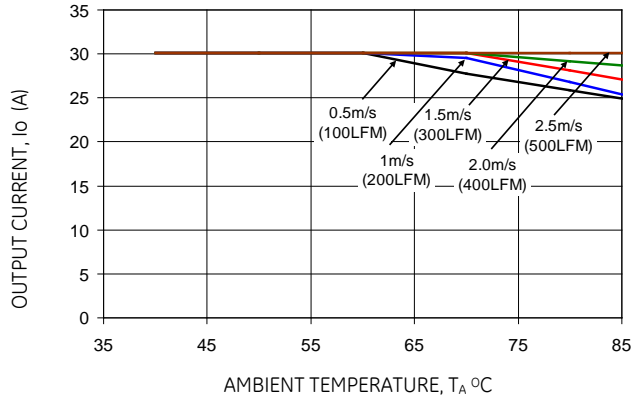

Figure 28. Derating Output Current versus Ambient Temperature and Airflow (ATS030A0X3-SRH).

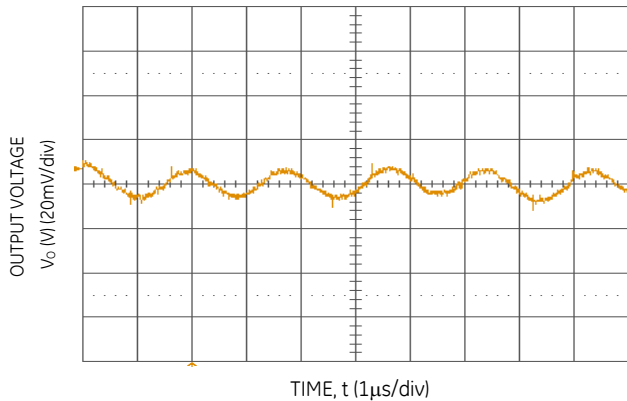

Figure 26. Typical output ripple and noise ( $V_{IN} = V_{IN,NOM}$ ,  $I_o = I_{o,max}$ ).

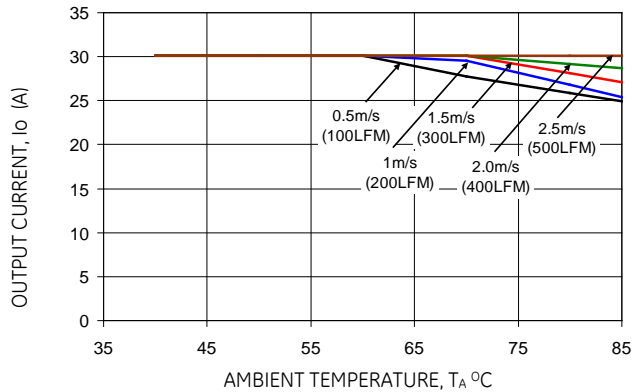

Figure 29. Derating Output Current versus Ambient Temperature and Airflow (ATH030A0X3-SR).

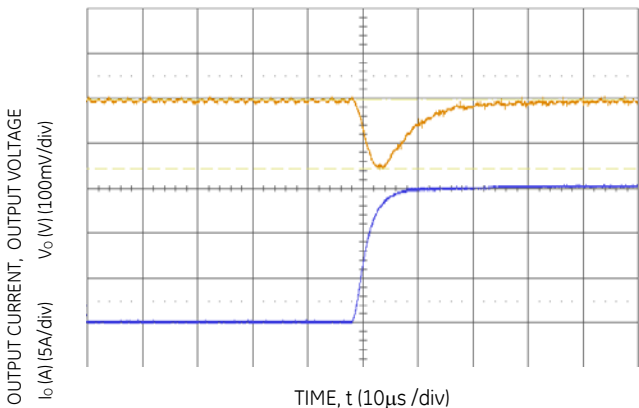

Figure 27. Transient Response to Dynamic Load Change from 0% to 50% of full load with  $V_{IN} = 5V$ .

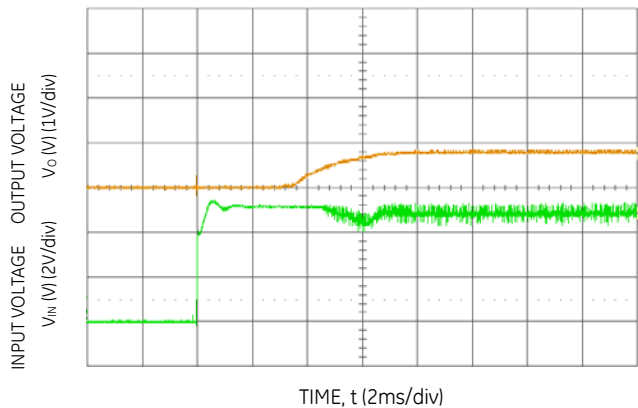

Figure 30. Typical Start-up Using Input Voltage ( $V_{IN} = V_{IN,NOM}$ ,  $I_o = I_{o,max}$ ).

# Austin MegaLynx™: Non-Isolated DC-DC Power Modules

4.5Vdc – 5.5Vdc input; 0.8Vdc to 3.63Vdc output; 30A Output Current

6Vdc – 14Vdc input; 0.8Vdc to 3.63Vdc output; 20/30A Output Current

## Characteristic Curves

The following figures provide typical characteristics for the ATH030A0X3-SR and -SRH (1.8V, 30A) at 25°C.

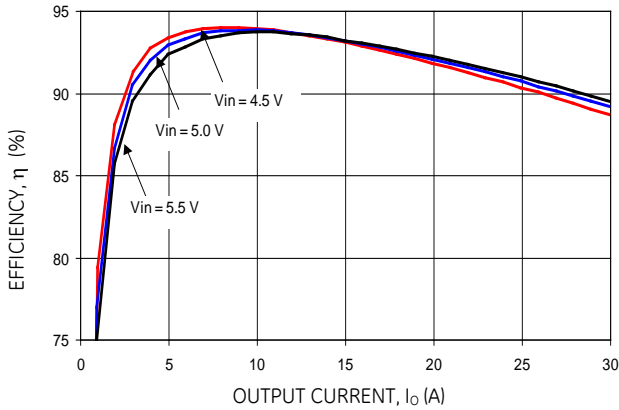

Figure 31. Converter Efficiency versus Output Current.

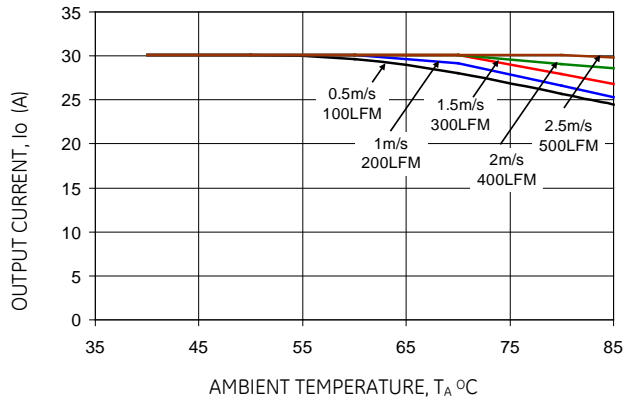

Figure 34. Derating Output Current versus Ambient Temperature and Airflow (ATH030A0X3-SRH).

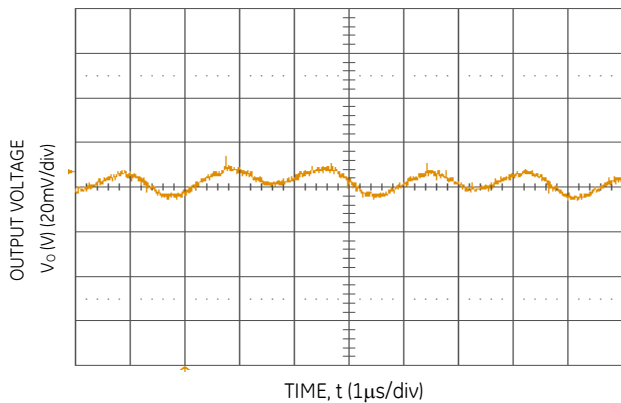

Figure 32. Typical output ripple and noise ( $V_{IN} = V_{IN,NOM}$ ,  $I_o = I_{o,max}$ ).

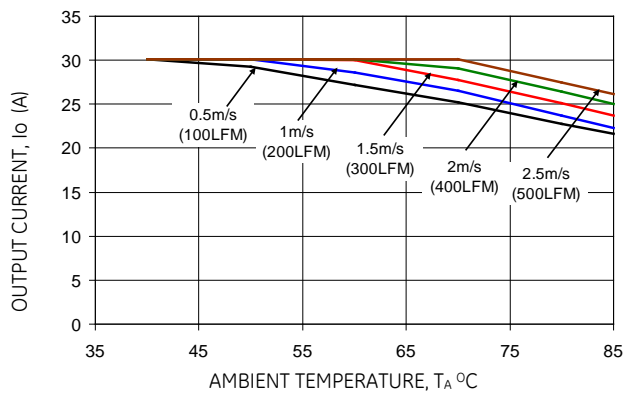

Figure 35. Derating Output Current versus Ambient Temperature and Airflow (ATH030A0X3-SR).

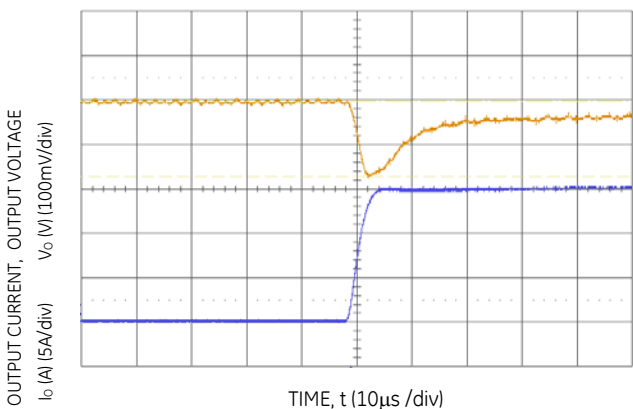

Figure 33. Transient Response to Dynamic Load Change from 0% to 50% of full load with  $V_{IN} = 5V$ .

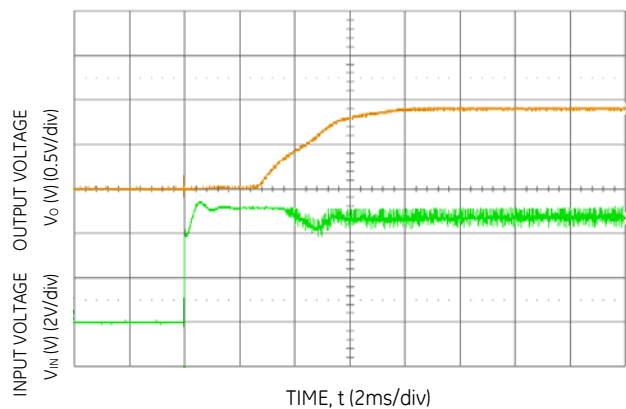

Figure 36. Typical Start-up Using Input Voltage ( $V_{IN} = V_{IN,NOM}$ ,  $I_o = I_{o,max}$ ).

# Austin MegaLynx™: Non-Isolated DC-DC Power Modules

4.5Vdc – 5.5Vdc input; 0.8Vdc to 3.63Vdc output; 30A Output Current

6Vdc – 14Vdc input; 0.8Vdc to 3.63Vdc output; 20/30A Output Current

## Characteristic Curves

The following figures provide typical characteristics for the ATH030A0X3-SR and -SRH (3.3V, 30A) at 25°C.

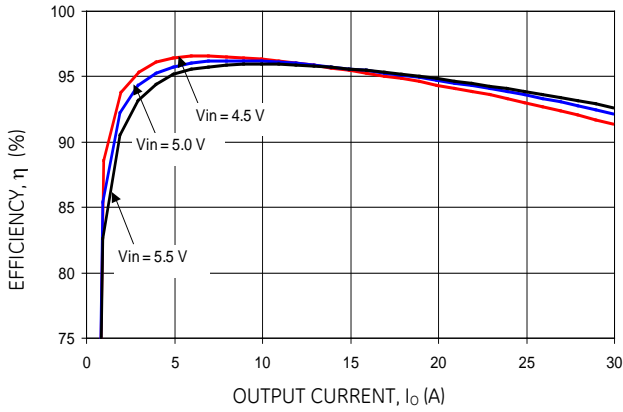

Figure 37. Converter Efficiency versus Output Current.

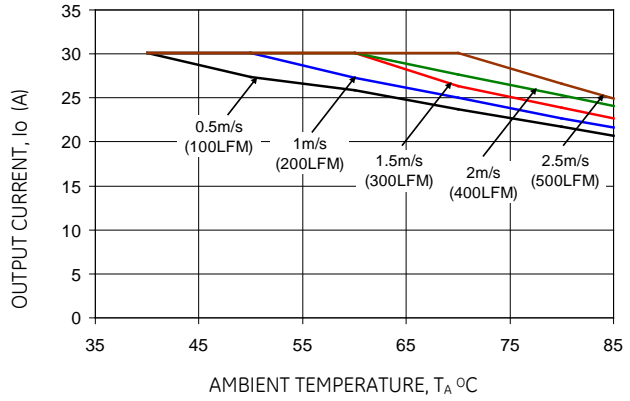

Figure 40. Derating Output Current versus Ambient Temperature and Airflow (ATH030A0X3-SRH).

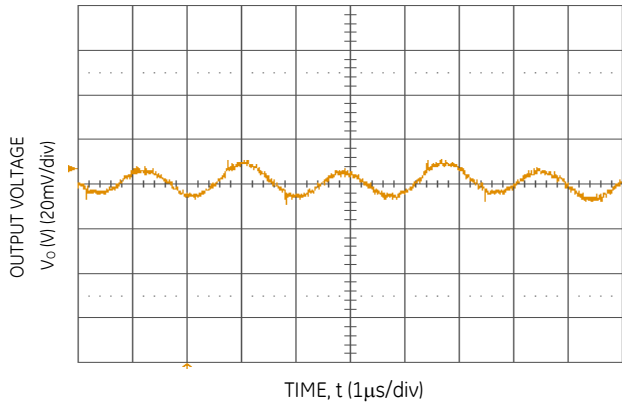

Figure 38. Typical output ripple and noise ( $V_{IN} = V_{IN,NOM}$ ,  $I_o = I_{o,max}$ ).

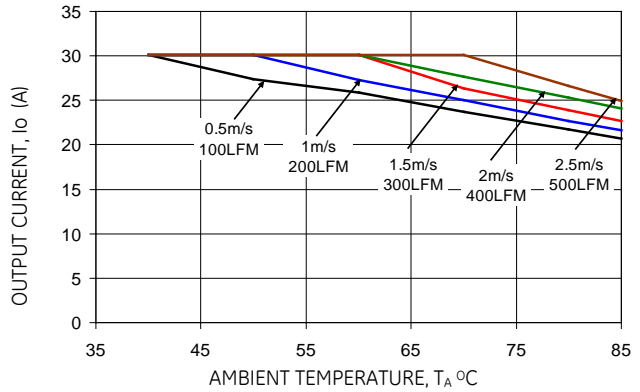

Figure 41. Derating Output Current versus Ambient Temperature and Airflow (ATH030A0X3-SR).

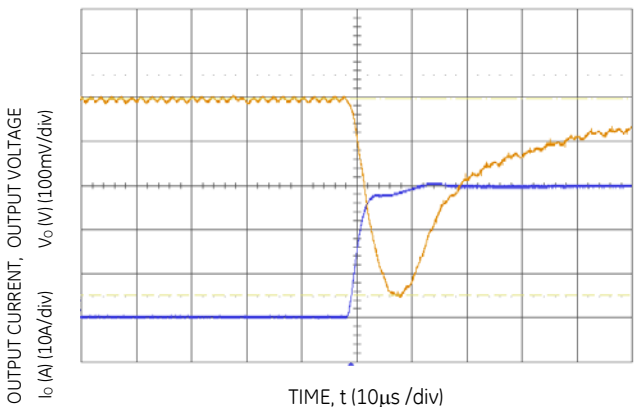

Figure 39. Transient Response to Dynamic Load Change from 0% to 50% of full load with  $V_{IN} = 5V$ .

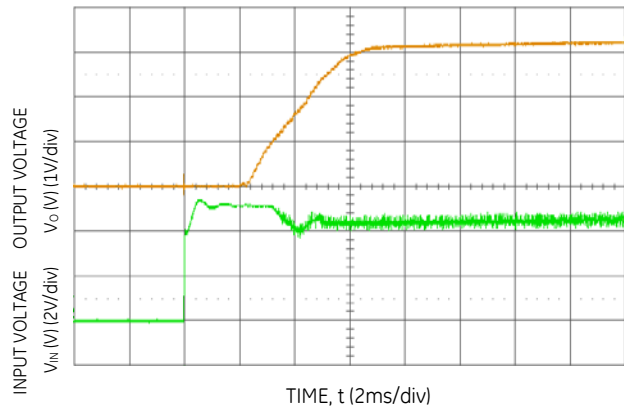

Figure 42. Typical Start-up Using Input Voltage ( $V_{IN} = V_{IN,NOM}$ ,  $I_o = I_{o,max}$ ).

# Austin MegaLynx™: Non-Isolated DC-DC Power Modules

4.5Vdc – 5.5Vdc input; 0.8Vdc to 3.63Vdc output; 30A Output Current

6Vdc – 14Vdc input; 0.8Vdc to 3.63Vdc output; 20/30A Output Current

## Test Configurations

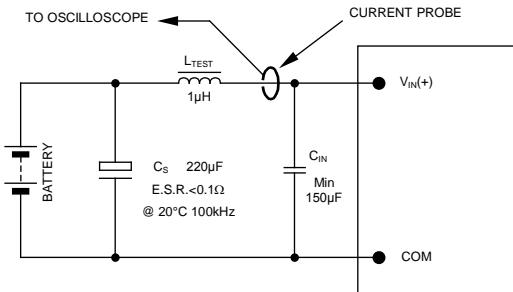

NOTE: Measure input reflected ripple current with a simulated source inductance ( $L_{TEST}$ ) of 1µH. Capacitor  $C_s$  offsets possible battery impedance. Measure current as shown above.

Figure 43. Input Reflected Ripple Current Test Setup.

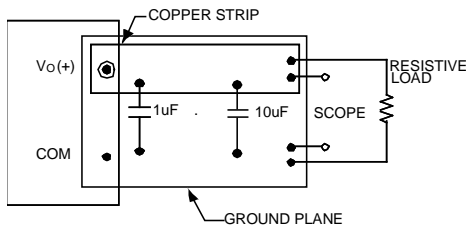

NOTE: All voltage measurements to be taken at the module terminals, as shown above. If sockets are used then Kelvin connections are required at the module terminals to avoid measurement errors due to socket contact resistance.

Figure 44. Output Ripple and Noise Test Setup.

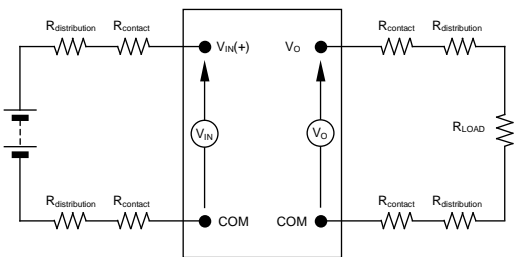

NOTE: All voltage measurements to be taken at the module terminals, as shown above. If sockets are used then Kelvin connections are required at the module terminals to avoid measurement errors due to socket contact resistance.

Figure 45. Output Voltage and Efficiency Test Setup.

$$\text{Efficiency } \eta = \frac{V_o \cdot I_o}{V_{IN} \cdot I_{IN}} \times 100 \%$$

## Design Considerations

The Austin MegaLynx™ module should be connected to a low-impedance source. A highly inductive source can affect the stability of the module. An input capacitor must be

placed directly adjacent to the input pin of the module, to minimize input ripple voltage and ensure module stability.

To minimize input voltage ripple, low-ESR ceramic capacitors are recommended at the input of the module. Figure 46 shows the input ripple voltage for various output voltages at 30A of load current with 1x22 µF or 2x22 µF ceramic capacitors and an input of 12V. Figure 47 shows data for the 5Vin case, with 2x22µF and 2x47µF of ceramic capacitors at the input, and for a load current of 30A.

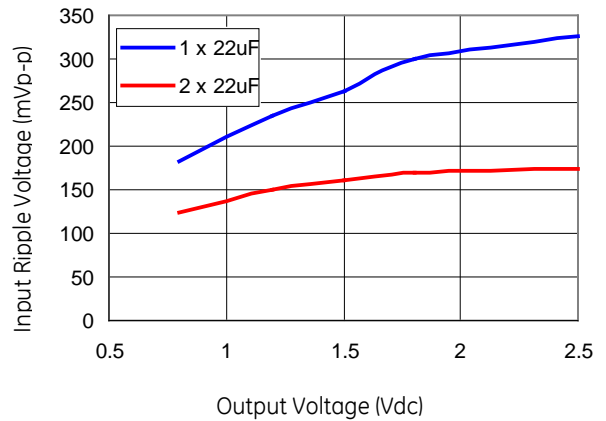

Figure 46. Input ripple voltage for various output voltages with 1x22 µF or 2x22 µF ceramic capacitors at the input (30A load). Input voltage is 12V.

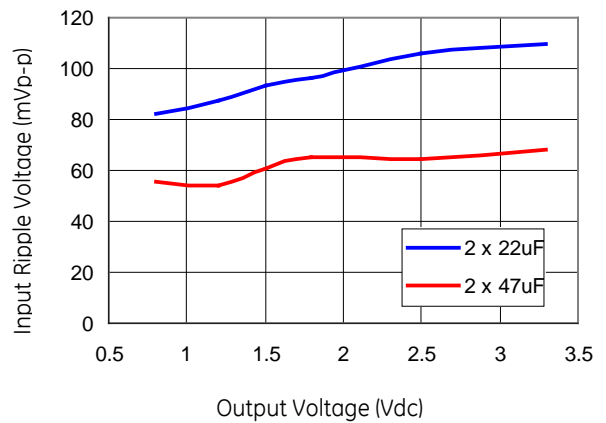

Figure 47. Input ripple voltage in mV, p-p for various output voltages with 2x22 µF or 2x47 µF ceramic capacitors at the input (30A load). Input voltage is 5V.

# Austin MegaLynx™: Non-Isolated DC-DC Power Modules

4.5Vdc – 5.5Vdc input; 0.8Vdc to 3.63Vdc output; 30A Output Current

6Vdc – 14Vdc input; 0.8Vdc to 3.63Vdc output; 20/30A Output Current

## Output Filtering

The Austin MegaLynx™ modules are designed for low output ripple voltage and will meet the maximum output ripple specification with 0.1  $\mu$ F ceramic and 10  $\mu$ F ceramic capacitors at the output of the module. However, additional output filtering may be required by the system designer for a number of reasons. First, there may be a need to further reduce the output ripple and noise of the module. Second, the dynamic response characteristics may need to be customized to a particular load step change.

To reduce the output ripple and improve the dynamic response to a step load change, additional capacitance at the output can be used. Low ESR polymer and ceramic capacitors are recommended to improve the dynamic response of the module. Figure 48 shows the output ripple voltage for various output voltages at 30A of load current with different external capacitance values and an input of 12V. Figure 49 shows data for the 5Vin case for various output voltages at 30A of load current with different external capacitance values. For stable operation of the module, limit the capacitance to less than the maximum output capacitance as specified in the electrical specification table.

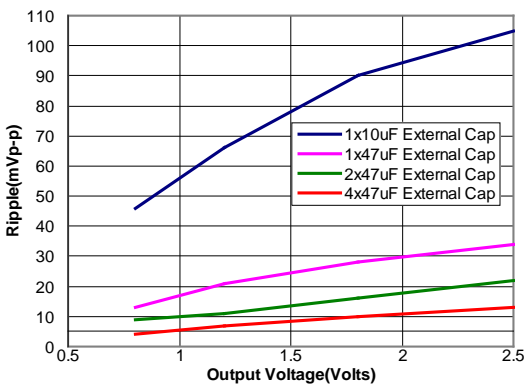

**Figure 48.** Output ripple voltage for various output voltages with external 1x10  $\mu$ F, 1x47  $\mu$ F, 2x47  $\mu$ F or 4x47  $\mu$ F ceramic capacitors at the output (30A load). Input voltage is 12V.

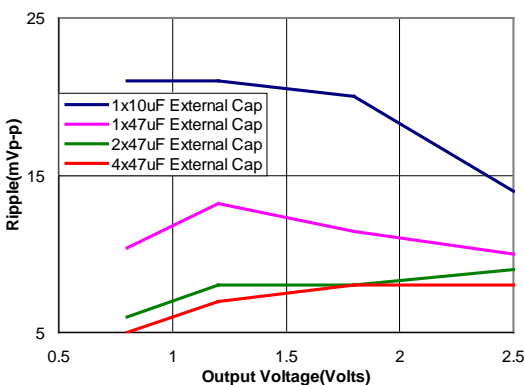

**Figure 49.** Output ripple voltage for various output voltages with external 1x10  $\mu$ F, 1x47  $\mu$ F, 2x47  $\mu$ F or 4x47  $\mu$ F ceramic capacitors at the output (30A load). Input voltage is 5V.

$\mu$ F ceramic capacitors at the output (30A load). Input voltage is 5V.

## Safety Considerations

For safety agency approval the power module must be installed in compliance with the spacing and separation requirements of the end-use safety agency standards, i.e., UL 60950, CSA C22.2 No. 60950-00, EN60950 (VDE 0850) (IEC60950, 3<sup>rd</sup> edition) Licensed.

For the converter output to be considered meeting the requirements of safety extra-low voltage (SELV), the input must meet SELV requirements. The power module has extra-low voltage (ELV) outputs when all inputs are ELV.

## Feature Descriptions

### Remote On/Off

The Austin MegaLynx™ SMT power modules feature a On/Off pin for remote On/Off operation. If not using the On/Off pin, connect the pin to ground (the module will be ON). The On/Off signal ( $V_{on/off}$ ) is referenced to ground. Circuit configuration for remote On/Off operation of the module using the On/Off pin is shown in Figure 50.

During a Logic High on the On/Off pin (transistor Q1 is OFF), the module remains OFF. The external resistor R1 should be chosen to maintain 3.0V minimum on the On/Off pin to ensure that the module is OFF when transistor Q1 is in the OFF state. Suitable values for R1 are 4.7K for input voltage of 12V and 3K for 5Vin. During Logic-Low when Q1 is turned ON, the module is turned ON. The ATS030A0X3-62SRHZ and ATS030A0X3-62SRPHZ modules have a higher value resistor of 100K connected internally between the gate and source of the internal FET used to control the PWM Enable line.

The On/Off pin can also be used to synchronize the output voltage start-up and shutdown of multiple modules in parallel. By connecting On/Off pins of multiple modules, the output start-up can be synchronized (please refer to characterization curves). When On/Off pins are connected together, all modules will shutdown if any one of the modules gets disabled due to undervoltage lockout or over temperature protection.

# Austin MegaLynx™: Non-Isolated DC-DC Power Modules

4.5Vdc – 5.5Vdc input; 0.8Vdc to 3.63Vdc output; 30A Output Current

6Vdc – 14Vdc input; 0.8Vdc to 3.63Vdc output; 20/30A Output Current

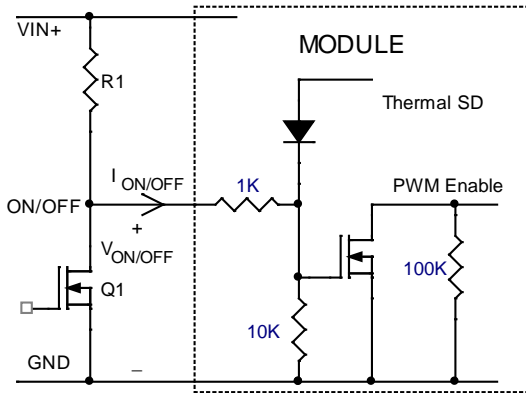

Figure 50. Remote On/Off Implementation using ON/OFF .

### Remote Sense

The Austin MegaLynx™ SMT power modules have a Remote Sense feature to minimize the effects of distribution losses by regulating the voltage at the Remote Sense pin (See Figure 51). The voltage between the Sense pin and Vo pin must not exceed 0.5V.

The amount of power delivered by the module is defined as the output voltage multiplied by the output current ( $V_o \times I_o$ ). When using Remote Sense, the output voltage of the module can increase, which, if the same output is maintained, increases the power output by the module. Make sure that the maximum output power of the module remains at or below the maximum rated power. When the Remote Sense feature is not being used, connect the Remote Sense pin to output of the module.

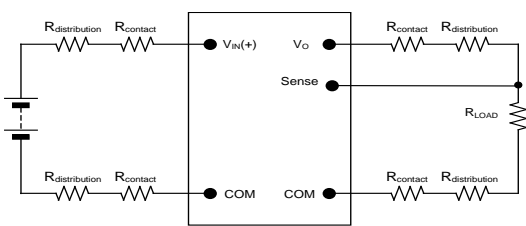

Figure 51. Effective Circuit Configuration for Remote Sense operation.

### Over Current Protection

To provide protection in a fault (output overload) condition, the unit is equipped with internal current-limiting circuitry and can endure current limiting continuously. At the point of current-limit inception, the unit enters hiccup mode. The unit operates normally once the output current is brought back into its specified range. The average output current during hiccup is  $10\% I_{o,max}$ .

### Over Temperature Protection

To provide protection in a fault condition, the unit is equipped with a thermal shutdown circuit. The unit will shutdown if the overtemperature threshold of 125°C is exceeded at the thermal reference point  $T_{ref}$ . The thermal shutdown is not intended as a guarantee that the unit will survive temperatures beyond its rating. Once the unit goes into thermal shutdown it will then wait to cool before attempting to restart.

### Input Under Voltage Lockout

At input voltages below the input undervoltage lockout limit, the module operation is disabled. The module will begin to operate at an input voltage above the undervoltage lockout turn-on threshold.

### Output Voltage Programming

The output voltage of the Austin MegaLynx™ can be programmed to any voltage from 0.8Vdc to 3.63Vdc by connecting a resistor (shown as  $R_{trim}$  in Figure 52) between Trim and GND pins of the module. Without an external resistor between Trim and GND pins, the output of the module will be 0.8Vdc. To calculate the value of the trim resistor,  $R_{trim}$  for a desired output voltage, use the following equation:

$$R_{trim} = \left[ \frac{1200}{V_o - 0.80} - 100 \right] \Omega$$

$R_{trim}$  is the external resistor in  $\Omega$

$V_o$  is the desired output voltage

By using a  $\pm 0.5\%$  tolerance trim resistor with a TC of  $\pm 100$ ppm, a set point tolerance of  $\pm 1.5\%$  can be achieved as specified in the electrical specification. Table 1 provides  $R_{trim}$  values required for some common output voltages. The POL Programming Tool, available at [www.gecriticalpower.com](http://www.gecriticalpower.com) under the Design Tools section, helps determine the required external trim resistor needed for a specific output voltage.

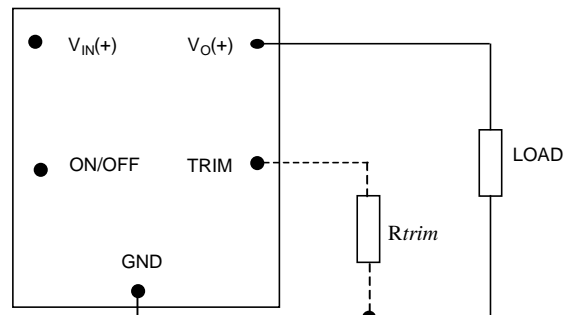

Figure 52. Circuit configuration to program output voltage using an external resistor.

Table 1



## Austin MegaLynx™: Non-Isolated DC-DC Power Modules

4.5Vdc – 5.5Vdc input; 0.8Vdc to 3.63Vdc output; 30A Output Current

6Vdc – 14Vdc input; 0.8Vdc to 3.63Vdc output; 20/30A Output Current

| $V_{o, set}$ (V) | $R_{trim}$ (K $\Omega$ ) |
|------------------|--------------------------|
| 0.8              | Open                     |
| 1.0              | 5.900                    |
| 1.2              | 2.900                    |
| 1.5              | 1.614                    |
| 1.8              | 1.100                    |
| 2.5              | 0.606                    |
| 3.3              | 0.380                    |

### Voltage Margining

Output voltage margining can be implemented in the Austin MegaLynx™ modules by connecting a resistor,  $R_{margin-up}$ , from the Trim pin to the ground pin for margining-up the output voltage and by connecting a resistor,  $R_{margin-down}$ , from the Trim pin to output pin for margining-down. Figure 53 shows the circuit configuration for output voltage margining. The POL Programming Tool, available at [www.gecriticalpower.com](http://www.gecriticalpower.com) under the Design Tools section, also calculates the values of  $R_{margin-up}$  and  $R_{margin-down}$  for a specific output voltage and % margin. Please consult your local GE technical representative for additional details.

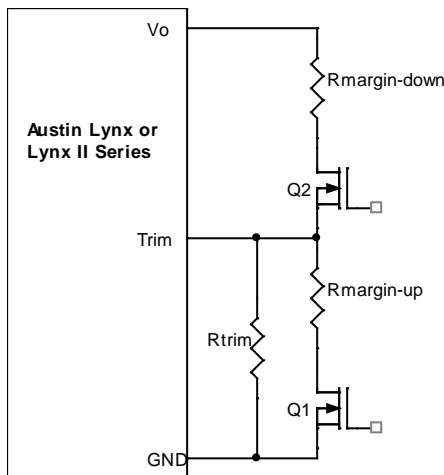

Figure 53. Circuit Configuration for margining Output voltage.

### Voltage Sequencing

The Austin MegaLynx™ series of modules include a sequencing feature that enables users to implement various types of output voltage sequencing in their applications. This is accomplished via an additional sequencing pin. When not using the sequencing feature, either leave the SEQ pin unconnected or tied to  $V_{IN}$ .

For proper voltage sequencing, first, input voltage is applied to the module. The On/Off pin of the module is or tied to GND so that the module is ON by default. After applying input voltage to the module, a delay of 10msec minimum is

required before applying voltage on the SEQ pin. During this delay time, the SEQ pin should be kept at a voltage of 50mV ( $\pm 20$  mV). After the 10msec delay, the voltage applied to the SEQ pin is allowed to vary and the output voltage of the module will track this voltage on a one-to-one volt basis until the output reaches the set-point voltage. To initiate simultaneous shutdown of the modules, the SEQ pin voltage is lowered in a controlled manner. The output voltages of the modules track the sequence pin voltage when it falls below their set-point voltages. A valid input voltage must be maintained until the tracking and output voltages reach zero to ensure a controlled shutdown of the modules. For a more detailed description of sequencing, please refer to **Application Note AN04-008 titled "Guidelines for Sequencing of Multiple Modules"**.

When using the EZ-SEQUENCE™ feature to control start-up of the module, pre-bias immunity feature during start-up is disabled. The pre-bias immunity feature of the module relies on the module being in the diode-mode during start-up. When using the EZ-SEQUENCE™ feature, modules goes through an internal set-up time of 10msec, and will be in synchronous rectification mode when voltage at the SEQ pin is applied. This will result in sinking current in the module if pre-bias voltage is present at the output of the module. When pre-bias immunity during start-up is required, the EZ-SEQUENCE™ feature must be disabled.

### Active Load Sharing (-P Option)

For additional power requirements, the Austin MegaLynx series power module is also available with a parallel option. Up to five modules can be configured, in parallel, with active load sharing. Good layout techniques should be observed when using multiple units in parallel. To implement forced load sharing, the following connections should be made:

- The share pins of all units in parallel must be connected together. The path of these connections should be as direct as possible.
- All remote-sense pins should be connected to the power bus at the same point, i.e., connect all the SENSE(+) pins to the (+) side of the bus. Close proximity and directness are necessary for good noise immunity

Some special considerations apply for design of converters in parallel operation:

- When sizing the number of modules required for parallel operation, take note of the fact that current sharing has some tolerance. In addition, under transient conditions such as a dynamic load change and during startup, all converter output currents will not be equal. To allow for such variation and avoid the likelihood of a converter shutting off due to a current overload, the total capacity of the paralleled system should be no more than 75% of the sum of the individual converters. As an example, for a system of four ATS030A0X3-SR converters the parallel, the total

## Austin MegaLynx™: Non-Isolated DC-DC Power Modules

4.5Vdc – 5.5Vdc input; 0.8Vdc to 3.63Vdc output; 30A Output Current

6Vdc – 14Vdc input; 0.8Vdc to 3.63Vdc output; 20/30A Output Current

current drawn should be less than 75% of (4 x 30A) , i.e. less than 90A.

- All modules should be turned on and off together. This is so that all modules come up at the same time avoiding the problem of one converter sourcing current into the other leading to an overcurrent trip condition. To ensure that all modules come up simultaneously, the on/off pins of all paralleled converters should be tied together and the converters enabled and disabled using the on/off pin.
- The share bus is not designed for redundant operation and the system will be non-functional upon failure of one of the unit when multiple units are in parallel. In particular, if one of the converters shuts down during operation, the other converters may also shut down due to their outputs hitting current limit. In such a situation, unless a coordinated restart is ensured, the system may never properly restart since different converters will try to restart at different times causing an overload condition and subsequent shutdown. This situation can be avoided by having an external output voltage monitor circuit that detects a shutdown condition and forces all converters to shut down and restart together.

# Austin MegaLynx™: Non-Isolated DC-DC Power Modules

4.5Vdc – 5.5Vdc input; 0.8Vdc to 3.63Vdc output; 30A Output Current

6Vdc – 14Vdc input; 0.8Vdc to 3.63Vdc output; 20/30A Output Current

## Thermal Considerations

Power modules operate in a variety of thermal environments; however, sufficient cooling should always be provided to help ensure reliable operation.

Considerations include ambient temperature, airflow, module power dissipation, and the need for increased reliability. A reduction in the operating temperature of the module will result in an increase in reliability. The thermal data presented here is based on physical measurements taken in a wind tunnel. The test set-up is shown in Figure 54. Note that the airflow is parallel to the short axis of the module as shown in Figure 55. The derating data applies to airflow in either direction of the module's long axis.

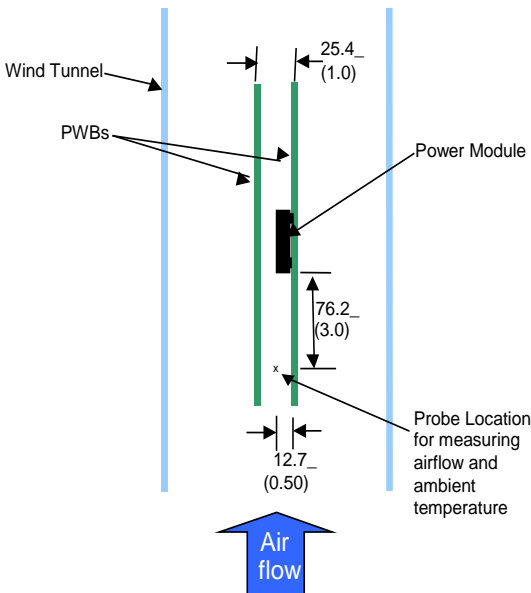

Figure 54. Thermal Test Setup.

The thermal reference points,  $T_{ref}$  used in the specifications are shown in Figure 56. For reliable operation the temperatures at these points should not exceed 125°C. The output power of the module should not exceed the rated power of the module ( $V_{o,set} \times I_{o,max}$ ).

Please refer to the Application Note "Thermal Characterization Process For Open-Frame Board-Mounted Power Modules" for a detailed discussion of thermal aspects including maximum device temperatures.

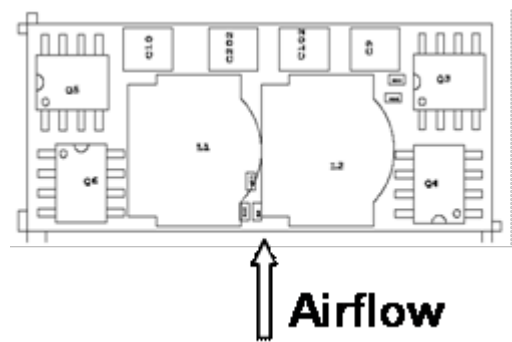

Figure 55. Airflow direction for thermal testing.

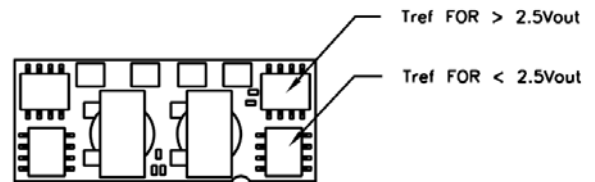

Figure 56.  $T_{ref}$  Temperature measurement location.

# Austin MegaLynx™: Non-Isolated DC-DC Power Modules

4.5Vdc – 5.5Vdc input; 0.8Vdc to 3.63Vdc output; 30A Output Current

6Vdc – 14Vdc input; 0.8Vdc to 3.63Vdc output; 20/30A Output Current

## Mechanical Outline of Module (ATH030A0X3-SRPH/ATS030/020A0X3-SRPH)

Dimensions are in millimeters and (inches).

Tolerances: x.x mm ± 0.5 mm (x.xx in. ± 0.02 in.) [unless otherwise indicated]

x.xx mm ± 0.25 mm (x.xxx in ± 0.010 in.)

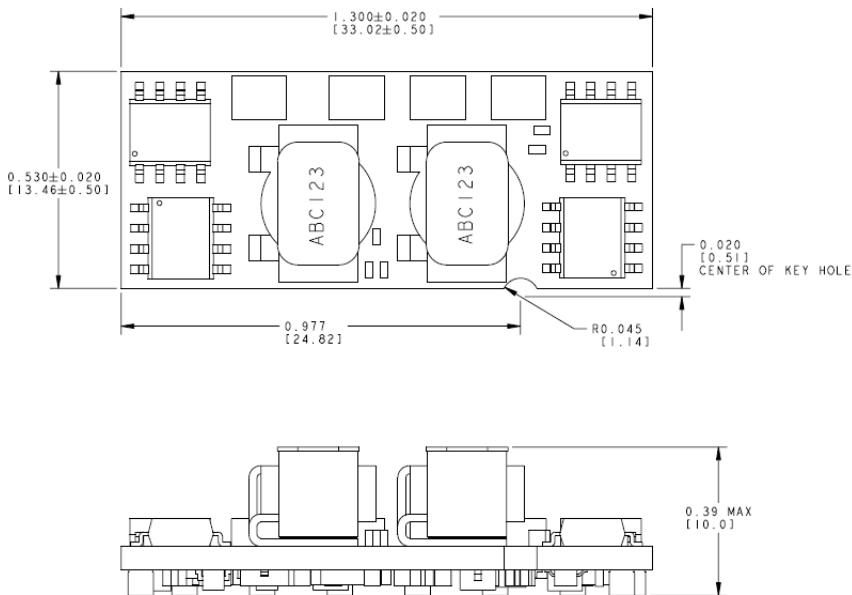
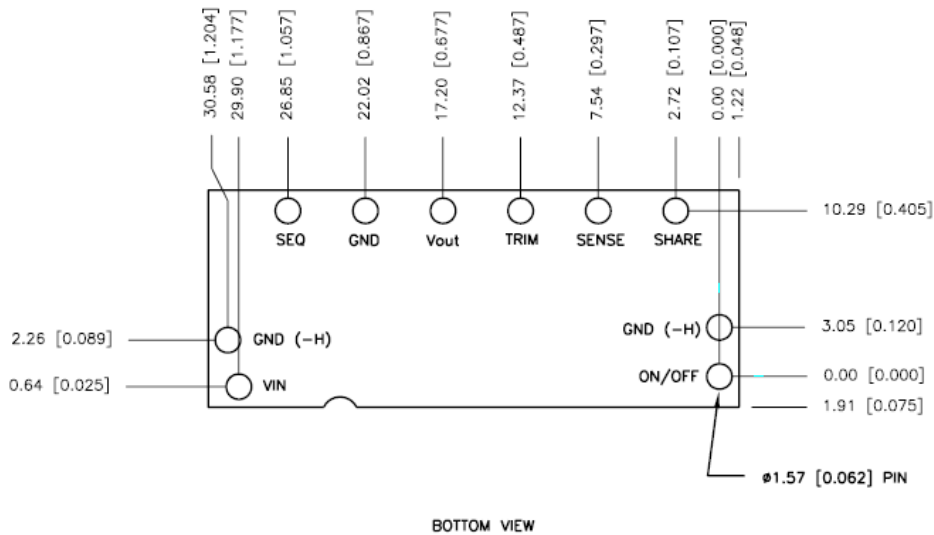

COPLANARITY SHALL BE DEFINED AS WHEN THE MODULE IS PLACED ONTO A FLAT SURFACE, THE CONTACTING SURFACE SHALL NOT BE MORE THAN 0.004"

**Note:** For the ATH030A0X3-SRH and ATS030/020A0X3-SRH modules, the SHARE pin is omitted since these modules are not capable of being paralleled.

## Austin MegaLynx™: Non-Isolated DC-DC Power Modules

4.5Vdc – 5.5Vdc input; 0.8Vdc to 3.63Vdc output; 30A Output Current

6Vdc – 14Vdc input; 0.8Vdc to 3.63Vdc output; 20/30A Output Current

### Recommended Pad Layout (ATH030A0X3-SRPH/ATS030/020A0X3-SRPH)

Dimensions are in millimeters and (inches).

Tolerances: x.x mm ± 0.5 mm (x.xx in. ± 0.02 in.) [unless otherwise indicated]

x.xx mm ± 0.25 mm (x.xxx in ± 0.010 in.)

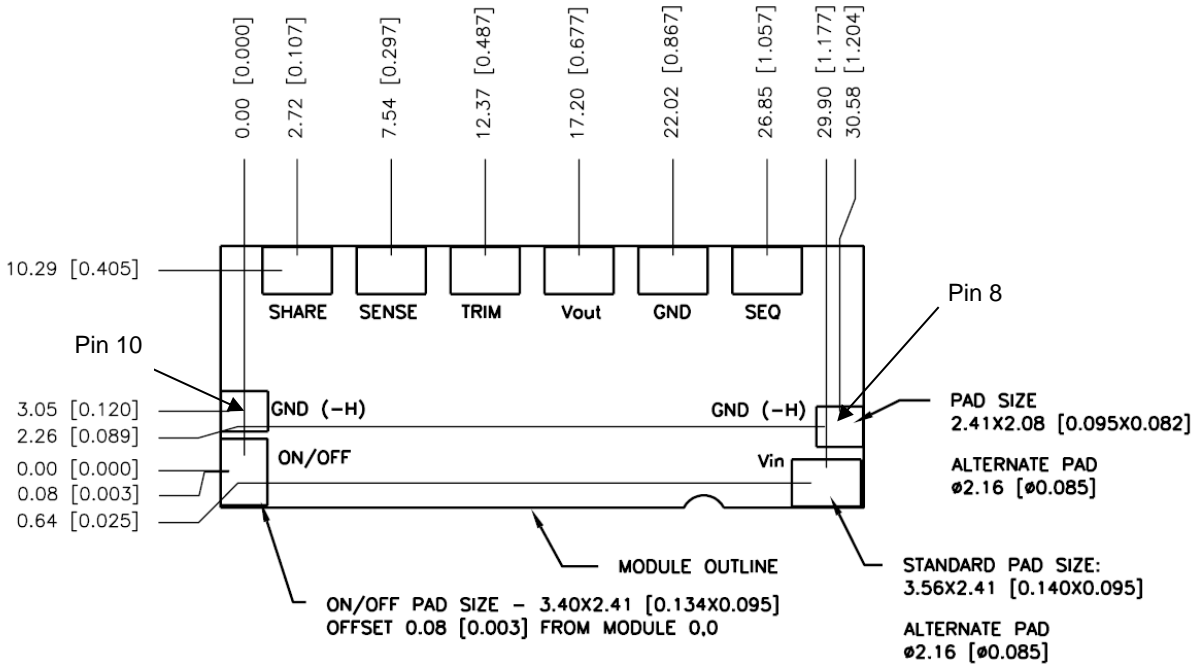

| PIN | FUNCTION | PIN | FUNCTION |
|-----|----------|-----|----------|
| 1   | On/Off   | 6   | Trim     |
| 2   | VIN      | 7   | Sense    |
| 3   | SEQ      | 8   | GND      |
| 4   | GND      | 9   | SHARE    |
| 5   | VOUT     | 10  | GND      |

**Note:** For the ATH030A0X3-SRH and ATS030/020A0X3-SRH modules, the SHARE pin is omitted since these modules are not capable of being paralleled.

# Austin MegaLynx™: Non-Isolated DC-DC Power Modules

4.5Vdc – 5.5Vdc input; 0.8Vdc to 3.63Vdc output; 30A Output Current

6Vdc – 14Vdc input; 0.8Vdc to 3.63Vdc output; 20/30A Output Current

## Mechanical Outline of Module (ATH030A0X3-SRP/ATS030/020A0X3-SRP)

Dimensions are in millimeters and (inches).

Tolerances: x.x mm ± 0.5 mm (x.xx in. ± 0.02 in.) [unless otherwise indicated]

x.xx mm ± 0.25 mm (x.xxx in ± 0.010 in.)

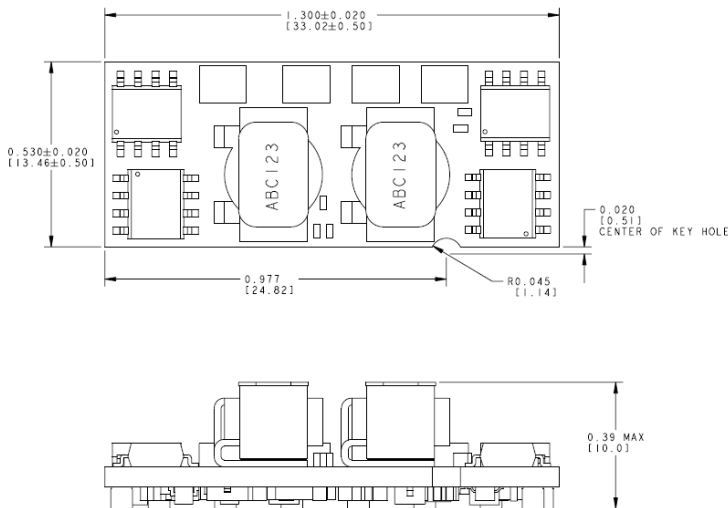
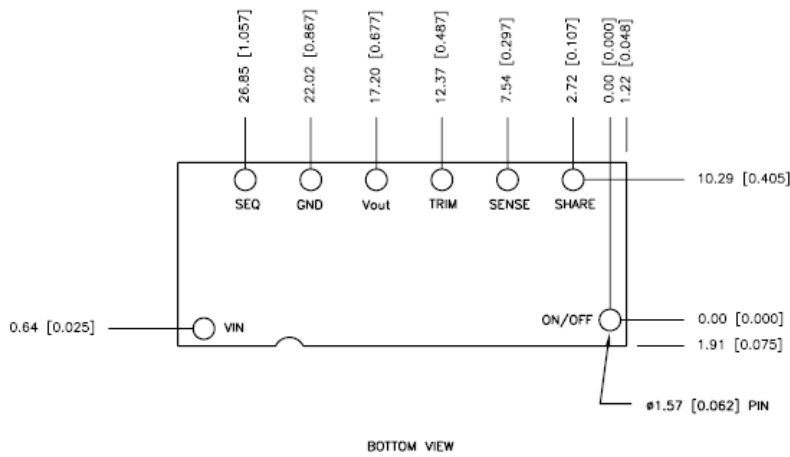

COPLANARITY SHALL BE DEFINED AS WHEN THE MODULE IS PLACED ONTO A FLAT SURFACE, THE CONTACTING SURFACE SHALL NOT BE MORE THAN 0.004"

## Austin MegaLynx™: Non-Isolated DC-DC Power Modules

4.5Vdc – 5.5Vdc input; 0.8Vdc to 3.63Vdc output; 30A Output Current

6Vdc – 14Vdc input; 0.8Vdc to 3.63Vdc output; 20/30A Output Current

### Recommended Pad Layout (ATH030A0X3-SRP/ATS030/020A0X3-SRP)

Dimensions are in millimeters and (inches).

Tolerances: x.x mm ± 0.5 mm (x.xx in. ± 0.02 in.) [unless otherwise indicated]

x.xx mm ± 0.25 mm (x.xxx in ± 0.010 in.)

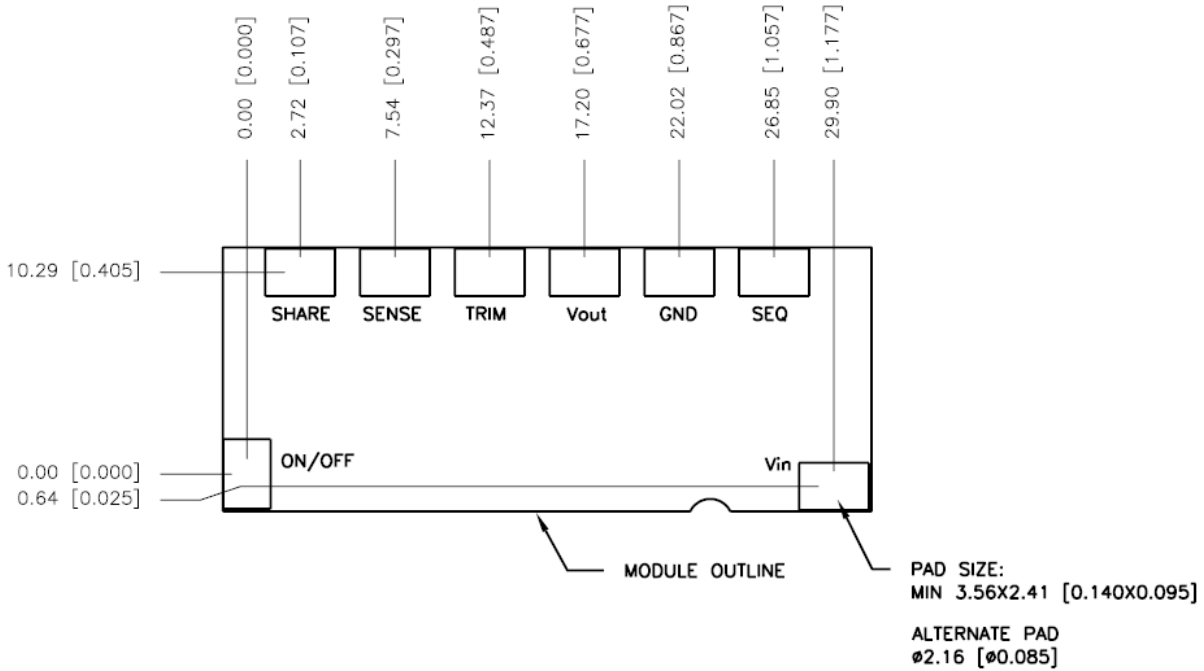

| PIN | FUNCTION         | PIN | FUNCTION |
|-----|------------------|-----|----------|
| 1   | On/Off           | 6   | Trim     |
| 2   | V <sub>IN</sub>  | 7   | Sense    |
| 3   | SEQ              | 8   | No Pin   |
| 4   | GND              | 9   | Share    |
| 5   | V <sub>OUT</sub> | 10  | No Pin   |

**Note:** For the ATH030A0X3-SR and ATS030/020A0X3-SR modules, the SHARE pin is omitted since these modules are not capable of being paralleled.

## Austin MegaLynx™: Non-Isolated DC-DC Power Modules

4.5Vdc – 5.5Vdc input; 0.8Vdc to 3.63Vdc output; 30A Output Current

6Vdc – 14Vdc input; 0.8Vdc to 3.63Vdc output; 20/30A Output Current

### Packaging Details

The Austin MegaLynx™ SMT version is supplied in tape & reel as standard. Modules are shipped in quantities of 200 modules per reel.

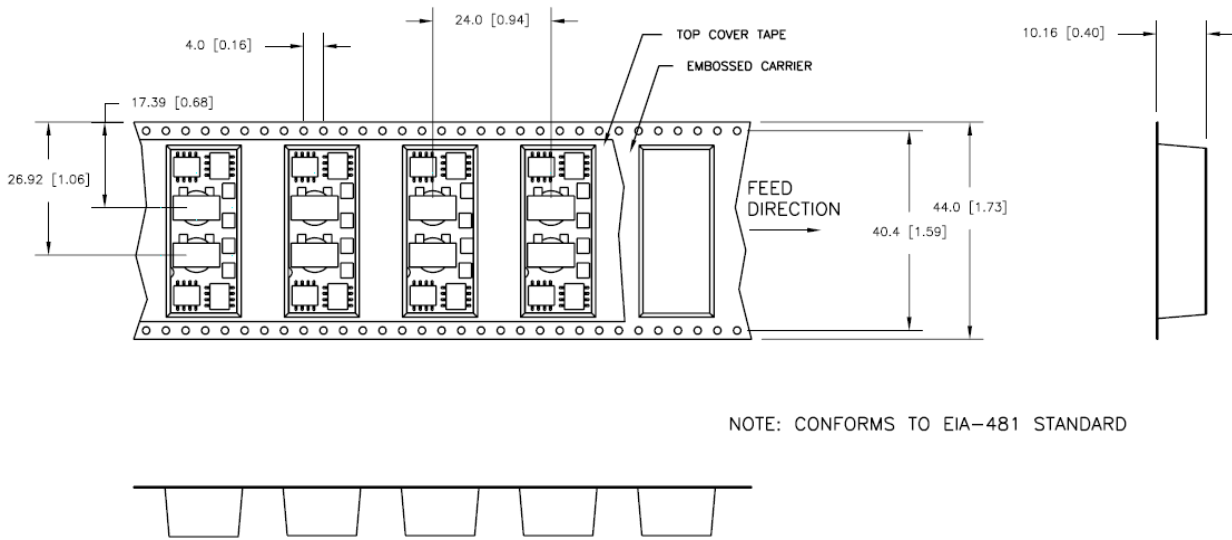

All Dimensions are in millimeters and (in inches).

#### Reel Dimensions

- Outside diameter: 330.2 (13.0)
- Inside diameter: 177.8 (7.0)
- Tape Width: 44.0 (1.73)



# Austin MegaLynx™: Non-Isolated DC-DC Power Modules

4.5Vdc – 5.5Vdc input; 0.8Vdc to 3.63Vdc output; 30A Output Current

6Vdc – 14Vdc input; 0.8Vdc to 3.63Vdc output; 20/30A Output Current

## Surface Mount Information

### Pick and Place

The Austin MegaLynx™ SMT modules use an open frame construction and are designed for a fully automated assembly process. The modules are fitted with a label designed to provide a large surface area for pick and place operations. The label meets all the requirements for surface mount processing, as well as safety standards, and is able to withstand reflow temperatures of up to 300°C. The label also carries product information such as product code, serial number and location of manufacture.

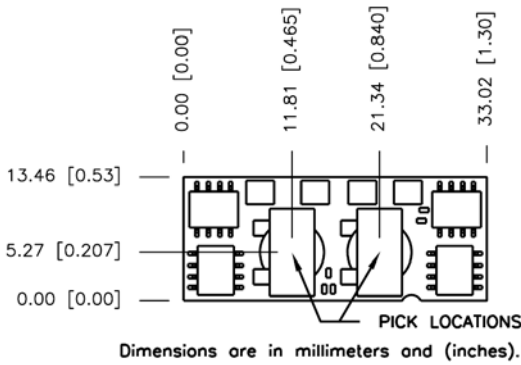

Figure 57. Pick and Place Location.

### Nozzle Recommendations

The module weight has been kept to a minimum by using open frame construction. Even so, these modules have a relatively large mass when compared to conventional SMT components. Variables such as nozzle size, tip style, vacuum pressure and pick & placement speed should be considered to optimize this process. The minimum recommended inside nozzle diameter for reliable operation is 3mm. The maximum nozzle outer diameter, which will safely fit within the allowable component spacing, is 5 mm max.

### Tin Lead Soldering

The Austin MegaLynx™ SMT power modules are lead free modules and can be soldered either in a lead-free solder process or in a conventional Tin/Lead (Sn/Pb) process. It is recommended that the customer review data sheets in order to customize the solder reflow profile for each application board assembly. The following instructions must be observed when soldering these units. Failure to observe these instructions may result in the failure of or cause damage to the modules, and can adversely affect long-term reliability.

In a conventional Tin/Lead (Sn/Pb) solder process peak reflow temperatures are limited to less than 235°C. Typically, the eutectic solder melts at 183°C, wets the land, and subsequently wicks the device connection. Sufficient time must be allowed to fuse the plating on the connection to ensure a reliable solder joint. There are several types of SMT reflow technologies currently used in the industry. These surface mount power modules can be reliably soldered using natural forced convection, IR (radiant infrared), or a combination of convection/IR. For reliable soldering the solder reflow profile should be established by accurately measuring the modules CP connector temperatures.

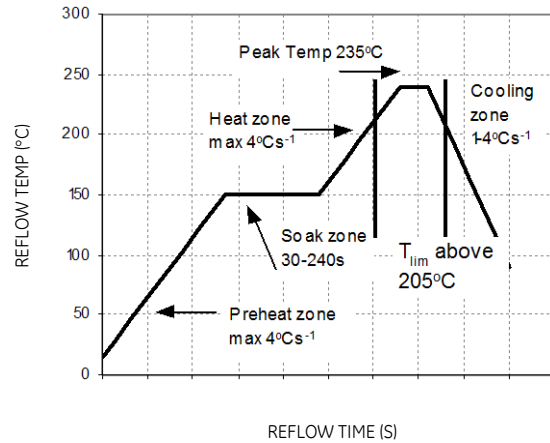

Figure 58. Reflow Profile for Tin/Lead (Sn/Pb) process.

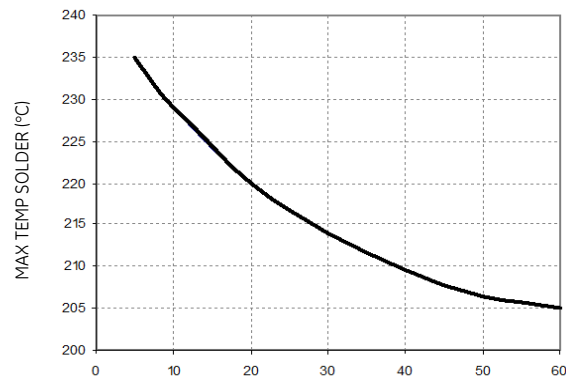

Figure 59. Time Limit Curve Above 205°C Reflow for Tin Lead (Sn/Pb) process.

## Austin MegaLynx™: Non-Isolated DC-DC Power Modules

4.5Vdc – 5.5Vdc input; 0.8Vdc to 3.63Vdc output; 30A Output Current

6Vdc – 14Vdc input; 0.8Vdc to 3.63Vdc output; 20/30A Output Current

### Surface Mount Information (continued)

#### Lead Free Soldering

The -Z version MegaLynx SMT modules are lead-free (Pb-free) and RoHS compliant and are both forward and backward compatible in a Pb-free and a SnPb soldering process. Failure to observe the instructions below may result in the failure of or cause damage to the modules and can adversely affect long-term reliability.

#### Pb-free Reflow Profile

Power Systems will comply with J-STD-020 Rev. C (Moisture/Reflow Sensitivity Classification for Nonhermetic Solid State Surface Mount Devices) for both Pb-free solder profiles and MSL classification procedures. This standard provides a recommended forced-air-convection reflow profile based on the volume and thickness of the package (table 4-2). The suggested Pb-free solder paste is Sn/Ag/Cu (SAC). The recommended linear reflow profile using Sn/Ag/Cu solder is shown in Figure. 60.

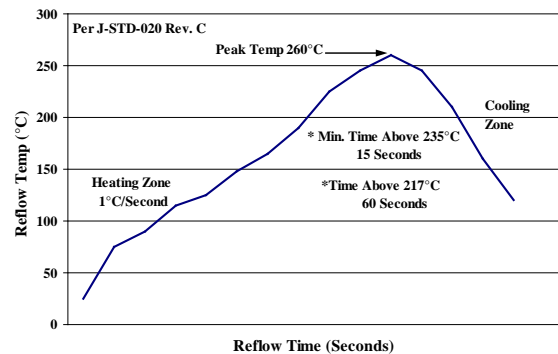

Figure 60. Recommended linear reflow profile using Sn/Ag/Cu solder

#### MSL Rating

The Austin MegaLynx™ SMT modules have a MSL rating of 2a.

#### Storage and Handling

The recommended storage environment and handling procedures for moisture-sensitive surface mount packages is detailed in J-STD-033 Rev. A (Handling, Packing, Shipping and Use of Moisture/Reflow Sensitive Surface Mount Devices). Moisture barrier bags (MBB) with desiccant are required for MSL ratings of 2 or greater. These sealed packages should not be broken until time of use. Once the original package is broken, the floor life of the product at conditions of ≤ 30°C and 60% relative humidity varies according to the MSL rating (see J-STD-033A). The shelf life for dry packed SMT packages will be a minimum of 12 months from the bag seal date, when stored at the following conditions: < 40° C, < 90% relative humidity.

#### Post Solder Cleaning and Drying Considerations

Post solder cleaning is usually the final circuit-board assembly process prior to electrical board testing. The result of inadequate cleaning and drying can affect both the reliability of a power module and the testability of the finished circuit-board assembly. For guidance on appropriate soldering, cleaning and drying procedures, refer to *Board Mounted Power Modules: Soldering and Cleaning Application Note (AN04-001)*.

## Austin MegaLynx™: Non-Isolated DC-DC Power Modules

4.5Vdc – 5.5Vdc input; 0.8Vdc to 3.63Vdc output; 30A Output Current

6Vdc – 14Vdc input; 0.8Vdc to 3.63Vdc output; 20/30A Output Current

### Ordering Information

Table 2. Device Codes

| Product codes       | Input Voltage | Output Voltage | Output Current | On/Off Logic | Connector Type | Comcodes    |
|---------------------|---------------|----------------|----------------|--------------|----------------|-------------|
| ATH030A0X3-SR       | 4.5 – 5.5Vdc  | 0.8 – 3.63Vdc  | 30A            | Negative     | SMT            | 108996625   |
| ATH030A0X3-SRZ      | 4.5 – 5.5Vdc  | 0.8 – 3.63Vdc  | 30A            | Negative     | SMT            | CC109109550 |
| ATH030A0X3-SRH      | 4.5 – 5.5Vdc  | 0.8 – 3.63Vdc  | 30A            | Negative     | SMT            | CC109102340 |
| ATH030A0X3-SRHZ     | 4.5 – 5.5Vdc  | 0.8 – 3.63Vdc  | 30A            | Negative     | SMT            | CC109109567 |
| ATH030A0X3-SRPH     | 4.5 – 5.5Vdc  | 0.8 – 3.63Vdc  | 30A            | Negative     | SMT            | 108996633   |
| ATH030A0X3-SRPHZ    | 4.5 – 5.5Vdc  | 0.8 – 3.63Vdc  | 30A            | Negative     | SMT            | CC109109583 |
| ATS030A0X3-SR       | 6.0 – 14Vdc   | 0.8 – 2.75Vdc  | 30A            | Negative     | SMT            | 108996591   |
| ATS030A0X3-SRZ      | 6.0 – 14Vdc   | 0.8 – 2.75Vdc  | 30A            | Negative     | SMT            | CC109109591 |
| ATS030A0X3-SRH      | 6.0 – 14Vdc   | 0.8 – 2.75Vdc  | 30A            | Negative     | SMT            | 108996600   |
| ATS030A0X3-SRHZ     | 6.0 – 14Vdc   | 0.8 – 2.75Vdc  | 30A            | Negative     | SMT            | CC109109600 |
| ATS030A0X3-SRPH     | 6.0 – 14Vdc   | 0.8 – 2.75Vdc  | 30A            | Negative     | SMT            | 108996617   |
| ATS030A0X3-SRPHZ    | 6.0 – 14Vdc   | 0.8 – 2.75Vdc  | 30A            | Negative     | SMT            | CC109105285 |
| ATS020A0X3-SR       | 6.0 – 14Vdc   | 0.8 – 3.63Vdc  | 20A            | Negative     | SMT            | CC109132544 |
| ATS020A0X3-SRH      | 6.0 – 14Vdc   | 0.8 – 3.63Vdc  | 20A            | Negative     | SMT            | CC109132552 |
| ATS020A0X3-SRPH     | 6.0 – 14Vdc   | 0.8 – 3.63Vdc  | 20A            | Negative     | SMT            | CC109132560 |
| ATS020A0X3-SRZ      | 6.0 – 14Vdc   | 0.8 – 3.63Vdc  | 20A            | Negative     | SMT            | CC109132577 |
| ATS020A0X3-SRHZ     | 6.0 – 14Vdc   | 0.8 – 3.63Vdc  | 20A            | Negative     | SMT            | CC109132585 |
| ATS020A0X3-SRPHZ    | 6.0 – 14Vdc   | 0.8 – 3.63Vdc  | 20A            | Negative     | SMT            | CC109132593 |
| ATS030A0X3-62SRHZ*  | 6.0 – 14Vdc   | 0.8 – 2.75Vdc  | 30A            | Negative     | SMT            | CC109139457 |
| ATS030A0X3-62SRPHZ* | 6.0 – 14Vdc   | 0.8 – 2.75Vdc  | 30A            | Negative     | SMT            | CC109140951 |
| ATS030A0X3-42SRPHZ* | 6.0 – 14Vdc   | 0.8 – 2.75Vdc  | 30A            | Negative     | SMT            | CC109145471 |

\* Special codes, consult factory before ordering

Table 3. Device Options

| Option              | Device Code Suffix |
|---------------------|--------------------|
| Current Share       | -P                 |
| 2 Extra ground pins | -H                 |
| RoHS Compliant      | -Z                 |

## Contact Us

For more information, call us at

USA/Canada:

**+1 877 546 3243**, or +1 972 244 9288

Asia-Pacific:

**+86.021.54279977\*808**

Europe, Middle-East and Africa:

**+49.89.878067-280**

[www.gecriticalpower.com](http://www.gecriticalpower.com)



GE Critical Power reserves the right to make changes to the product(s) or information contained herein without notice, and no liability is assumed as a result of their use or application. No rights under any patent accompany the sale of any such product(s) or information.



Компания «ЭлектроПласт» предлагает заключение долгосрочных отношений при поставках импортных электронных компонентов на взаимовыгодных условиях!

Наши преимущества:

- Оперативные поставки широкого спектра электронных компонентов отечественного и импортного производства напрямую от производителей и с крупнейших мировых складов;
- Поставка более 17-ти миллионов наименований электронных компонентов;
- Поставка сложных, дефицитных, либо снятых с производства позиций;
- Оперативные сроки поставки под заказ (от 5 рабочих дней);
- Экспресс доставка в любую точку России;
- Техническая поддержка проекта, помощь в подборе аналогов, поставка прототипов;
- Система менеджмента качества сертифицирована по Международному стандарту ISO 9001;
- Лицензия ФСБ на осуществление работ с использованием сведений, составляющих государственную тайну;
- Поставка специализированных компонентов (Xilinx, Altera, Analog Devices, Intersil, Interpoint, Microsemi, Aeroflex, Peregrine, Syfer, Eurofarad, Texas Instrument, Miteq, Cobham, E2V, MA-COM, Hittite, Mini-Circuits, General Dynamics и др.);

Помимо этого, одним из направлений компании «ЭлектроПласт» является направление «Источники питания». Мы предлагаем Вам помощь Конструкторского отдела:

- Подбор оптимального решения, техническое обоснование при выборе компонента;
- Подбор аналогов;
- Консультации по применению компонента;
- Поставка образцов и прототипов;
- Техническая поддержка проекта;
- Защита от снятия компонента с производства.



#### Как с нами связаться

**Телефон:** 8 (812) 309 58 32 (многоканальный)

**Факс:** 8 (812) 320-02-42

**Электронная почта:** [org@eplast1.ru](mailto:org@eplast1.ru)

**Адрес:** 198099, г. Санкт-Петербург, ул. Калинина, дом 2, корпус 4, литера А.