

300 mA CMOS LDO with Shutdown, Bypass and Independent Delayed Reset Function

Features

- LDO with Integrated Microcontroller Reset Monitor Functionality
- Low Input Supply Current (80 μ A, typical)
- Very Low Dropout Voltage
- 10 μ sec (typ.) Wake-Up Time from $\overline{\text{SHDN}}$
- 300 mA Output Current
- Standard or Custom Output and Detected Voltages
- Power-Saving Shutdown Mode
- Bypass Input for Quiet Operation
- Separate Input for Detected Voltage
- 140 msec Minimum $\overline{\text{RESET}}$ Output Duration
- Space-Saving MSOP Package
- Specified Junction Temperature Range:
-40°C to +125°C

Applications

- Battery-Operated Systems
- Portable Computers
- Medical Instruments
- Pagers
- Cellular / GSM / PHS Phones

Related Literature

- AN765, "Using Microchip's Micropower LDOs", DS00765.
- AN766, "Pin-Compatible CMOS Upgrades to Bipolar LDOs", DS00766.
- AN792, "A Method to Determine How Much Power a SOT23 Can Dissipate in an Application", DS00792.

Package Type

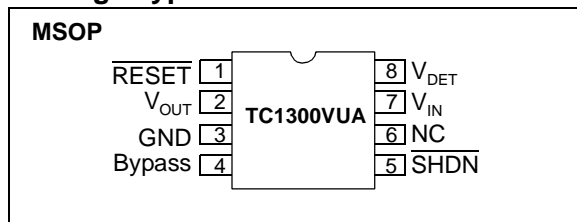

General Description

The TC1300 combines a low dropout regulator and a microcontroller reset monitor in an 8-Pin MSOP package. Total supply current is 80 μ A (typical), 20 to 60 times lower than bipolar regulators.

The TC1300 has a precise output with a typical accuracy of $\pm 0.5\%$. Other key features include low noise operation, low dropout voltage and internal feed-forward compensation for fast response to step changes in load. The TC1300 has both over-temperature and over-current protection. When the shutdown control ($\overline{\text{SHDN}}$) is low, the regulator output voltage falls to zero, $\overline{\text{RESET}}$ output remains valid and supply current is reduced to 30 μ A (typical). The TC1300 is rated for 300 mA of output current and stable with a 1 μ F output capacitor.

An active-low $\overline{\text{RESET}}$ is asserted when the detected voltage (V_{DET}) falls below the reset voltage threshold. The $\overline{\text{RESET}}$ output remains low for 300 msec (typical) after V_{DET} rises above reset threshold. The TC1300 also has a fast wake-up response time (10 μ sec., typical) when released from shutdown.

Typical Application Circuit

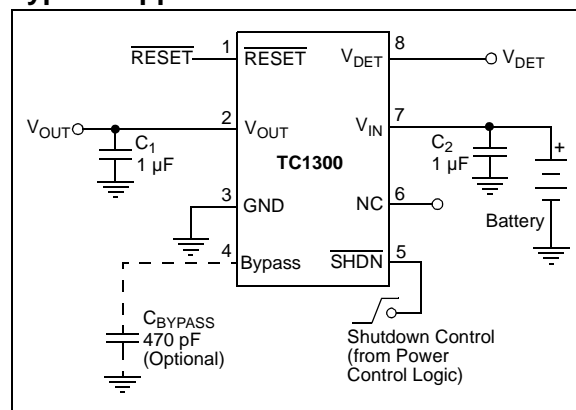

1.0 ELECTRICAL CHARACTERISTICS

Absolute Maximum Ratings*

Input Voltage6.5V
 Output Voltage (V_{SS} - 0.3) to (V_{IN} + 0.3)
 Power Dissipation Internally Limited (**Note 6**)
 Operating Junction Temperature, T_J - 40°C < T_J < 150°C
 Maximum Junction Temperature, T_J 150°C
 Storage Temperature..... - 65°C to +150°C
 Maximum Voltage on Any Pin (V_{SS}-0.3) to (V_{IN}+0.3)

***Notice:** Stresses above those listed under “maximum ratings” may cause permanent damage to the device. This is a stress rating only and functional operation of the device at those or any other conditions above those indicated in the operational listings of this specification is not implied. Exposure to maximum rating conditions for extended periods may affect device reliability.

PIN DESCRIPTIONS

Pin	Description
$\overline{\text{RESET}}$	$\overline{\text{RESET}}$ output remains low while V _{DET} is below the reset voltage threshold and for 300 msec after V _{DET} rises above reset threshold.
V _{OUT}	Regulated Voltage Output
GND	Ground Terminal
Bypass	Reference Bypass Input. Connecting an optional 470 pF to this input further reduces output noise.
$\overline{\text{SHDN}}$	Shutdown Control Input. The regulator is fully enabled when a logic high is applied to this input. The regulator enters shutdown when a logic low is applied to this input. During shutdown, regulator output voltage falls to zero, $\overline{\text{RESET}}$ output remains valid and supply current is reduced to 30 μA (typ.).
NC	No connect
V _{IN}	Power Supply Input
V _{DET}	Detected Input Voltage. V _{DET} and V _{IN} can be connected together.

ELECTRICAL CHARACTERISTICS

V_{IN} = V_{OUT} + 1V, I_L = 0.1 mA, C_L = 3.3 μF , $\overline{\text{SHDN}} > V_{IH}$, T_A = 25°C, unless otherwise noted. **BOLDFACE** type specifications apply for junction temperature (**Note 8**) of -40°C to +125°C.

Parameters	Sym	Min	Typ	Max	Units	Conditions
Input Operating Voltage	V _{IN}	2.7	—	6.0	V	Note 7
Maximum Output Current	I _{OUTMAX}	300	—	—	mA	
Output Voltage	V _{OUT}	— V_R - 2.5%	V _R ± 0.5% —	— V_R + 2.5%	V	Note 1
V _{OUT} Temperature Coefficient	$\Delta V_{OUT}/\Delta T$	—	25	—	ppm/°C	Note 2
Line Regulation	$\Delta V_{OUT}/\Delta V_{IN}$	—	0.02	0.35	%	(V _R + 1V) ≤ V _{IN} ≤ 6V
Load Regulation	$\Delta V_{OUT}/V_{OUT}$	—	0.5	2.0	%	I _L = 0.1 mA to I _{OUTMAX} , Note 3

Note 1: V_R is the regulator output voltage setting.

$$2: TC_{V_{OUT}} = \frac{(V_{OUTMAX} - V_{OUTMIN}) \times 10^6}{V_{OUT} \times \Delta T}$$

- Regulation is measured at a constant junction temperature using low duty cycle pulse testing. Load regulation is tested over a load range from 0.1 mA to the maximum specified output current. Changes in output voltage due to heating effects are covered by the thermal regulation specification.
- Dropout voltage is defined as the input to output differential at which the output voltage drops 2% below its nominal value measured at a 1V differential.
- Thermal Regulation is defined as the change in output voltage at a time t after a change in power dissipation is applied, excluding load or line regulation effects. Specifications are for a current pulse equal to I_{LMAX} at V_{IN} = 6V for t = 10 msec.
- The maximum allowable power dissipation is a function of ambient temperature, the maximum allowable junction temperature and the thermal resistance from junction-to-air (i.e. T_A, T_J, θ_{JA}). Exceeding the maximum allowable power dissipation causes the device to initiate thermal shutdown. Please see Section 4.0, “Thermal Considerations”, of this data sheet for more details.
- The minimum V_{IN} has to meet two conditions: V_{IN} ≥ 2.7V and V_{IN} ≥ (V_R + V_{DROPOUT}).
- The junction temperature of the device is approximated by soaking the device under test at an ambient temperature equal to the desired junction temperature. The test time is small enough such that the rise in the junction temperature over the ambient temperature is not significant.

ELECTRICAL CHARACTERISTICS (CONTINUED)

$V_{IN} = V_{OUT} + 1V$, $I_L = 0.1 \text{ mA}$, $C_L = 3.3 \mu\text{F}$, $\overline{\text{SHDN}} > V_{IH}$, $T_A = 25^\circ\text{C}$, unless otherwise noted. **BOLDFACE** type specifications apply for junction temperature (**Note 8**) of -40°C to $+125^\circ\text{C}$.

Parameters	Sym	Min	Typ	Max	Units	Conditions
Dropout Voltage (Note 4)	$V_{IN_V_{OUT}}$	—	1 70 210	30 130 390	mV	$I_L = 0.1 \text{ mA}$ $I_L = 100 \text{ mA}$ $I_L = 300 \text{ mA}$
Supply Current	I_{SS1}	—	80	160	μA	$\overline{\text{SHDN}} = V_{IH}$
Shutdown Supply Current	I_{SS2}	—	30	60	μA	$\overline{\text{SHDN}} = 0V$
Power Supply Rejection Ratio	PSRR	—	60	—	dB	$f \leq 1 \text{ kHz}$, $C_{\text{BYPASS}} = 1 \text{ nF}$
Output Short Circuit Current	$I_{\text{OUT_SC}}$	—	800	1200	mA	$V_{\text{OUT}} = 0V$
Thermal Regulation	$\Delta V_{\text{OUT}}/\Delta P_D$	—	0.04	—	%/W	Note 5
Output Noise	eN	—	900	—	nV/Hz	$f < 1 \text{ kHz}$, $C_{\text{OUT}} = 1 \mu\text{F}$, $R_{\text{LOAD}} = 50 \Omega$, $C_{\text{BYPASS}} = 1 \text{ nF}$
Wake-Up Time (from Shutdown Mode)	t_{WK}	—	10	20	μsec	$C_{\text{IN}} = 1 \mu\text{F}$, $V_{\text{IN}} = 5V$, $C_{\text{OUT}} = 4.7 \mu\text{F}$, $I_L = 30 \text{ mA}$, See Figure 3-2
Settling Time (from Shutdown Mode)	t_s	—	50	—	μsec	$C_{\text{IN}} = 1 \mu\text{F}$, $V_{\text{IN}} = 5V$ $C_{\text{OUT}} = 4.7 \mu\text{F}$ $I_L = 30 \text{ mA}$, See Figure 3-2
Thermal Shutdown Die Temperature	T_{SD}	—	150	—	$^\circ\text{C}$	
Thermal Shutdown Hysteresis	T_{HYS}	—	10	—	$^\circ\text{C}$	
Thermal Resistance Junction to Case	$R_{\theta\text{JA}}$	—	200	—	$^\circ\text{C/Watt}$	EIA/JEDEC JESD51-751-7 4-Layer Board
SHDN Input High Threshold	V_{IH}	45	—	—	$\%V_{\text{IN}}$	$V_{\text{IN}} = 2.5V$ to $6.0V$
SHDN Input Low Threshold	V_{IL}	—	—	15	$\%V_{\text{IN}}$	$V_{\text{IN}} = 2.5V$ to $6.0V$

Note 1: V_R is the regulator output voltage setting.

$$2: TC_{V_{\text{OUT}}} = \frac{(V_{\text{OUTMAX}} - V_{\text{OUTMIN}}) \times 10^6}{V_{\text{OUT}} \times \Delta T}$$

- 3: Regulation is measured at a constant junction temperature using low duty cycle pulse testing. Load regulation is tested over a load range from 0.1 mA to the maximum specified output current. Changes in output voltage due to heating effects are covered by the thermal regulation specification.
- 4: Dropout voltage is defined as the input to output differential at which the output voltage drops 2% below its nominal value measured at a 1V differential.
- 5: Thermal Regulation is defined as the change in output voltage at a time t after a change in power dissipation is applied, excluding load or line regulation effects. Specifications are for a current pulse equal to $I_{L_{\text{MAX}}}$ at $V_{\text{IN}} = 6V$ for $t = 10 \text{ msec}$.
- 6: The maximum allowable power dissipation is a function of ambient temperature, the maximum allowable junction temperature and the thermal resistance from junction-to-air (i.e. T_A , T_J , θ_{JA}). Exceeding the maximum allowable power dissipation causes the device to initiate thermal shutdown. Please see Section 4.0, "Thermal Considerations", of this data sheet for more details.
- 7: The minimum V_{IN} has to meet two conditions: $V_{\text{IN}} \geq 2.7V$ and $V_{\text{IN}} \geq (V_R + V_{\text{DROPOUT}})$.
- 8: The junction temperature of the device is approximated by soaking the device under test at an ambient temperature equal to the desired junction temperature. The test time is small enough such that the rise in the junction temperature over the ambient temperature is not significant.

TC1300

ELECTRICAL CHARACTERISTICS (CONTINUED)

$V_{IN} = V_{OUT} + 1V$, $I_L = 0.1 \text{ mA}$, $C_L = 3.3 \mu\text{F}$, $\overline{\text{SHDN}} > V_{IH}$, $T_A = 25^\circ\text{C}$, unless otherwise noted. **BOLDFACE** type specifications apply for junction temperature (**Note 8**) of -40°C to $+125^\circ\text{C}$.

Parameters	Sym	Min	Typ	Max	Units	Conditions
RESET Output						
Voltage Range	V_{DET}	1.0 1.2	—	6.0 6.0	V	$T_A = 0^\circ\text{C}$ to $+70^\circ\text{C}$ $T_A = -40^\circ\text{C}$ to $+125^\circ\text{C}$
Reset Threshold	V_{TH}	2.59	2.63	2.66	V	TC1300R-XX, $T_A = +25^\circ\text{C}$
		2.55	—	2.70		TC1300R-XX, $T_A = -40^\circ\text{C}$ to $+125^\circ\text{C}$
		2.36	2.40	2.43		TC1300Y-XX, $T_A = +25^\circ\text{C}$
		2.32	—	2.47		TC1300Y-XX, $T_A = -40^\circ\text{C}$ to $+125^\circ\text{C}$
Reset Threshold Tempco	$\Delta V_{TH} / \Delta T$	—	30	—	ppm/ $^\circ\text{C}$	
V_{DET} to Reset Delay	t_{RPD}	—	160	—	μsec	$V_{DET} = V_{TH}$ to $(V_{TH} - 100 \text{ mV})$
Reset Active Timeout Period	t_{RPU}	140	300	560	msec	
RESET Output Voltage Low	V_{OL}	—	—	0.3	V	$V_{DET} = V_{TH} \text{ min}$, $I_{SINK} = 1.2 \text{ mA}$
RESET Output Voltage High	V_{OH}	$0.8 V_{DET}$	—	—	V	$V_{DET} > V_{TH} \text{ max}$, $I_{SOURCE} = 500 \mu\text{A}$

Note 1: V_R is the regulator output voltage setting.

$$2: TCV_{OUT} = \frac{(V_{OUTMAX} - V_{OUTMIN}) \times 10^6}{V_{OUT} \times \Delta T}$$

- Regulation is measured at a constant junction temperature using low duty cycle pulse testing. Load regulation is tested over a load range from 0.1 mA to the maximum specified output current. Changes in output voltage due to heating effects are covered by the thermal regulation specification.
- Dropout voltage is defined as the input to output differential at which the output voltage drops 2% below its nominal value measured at a 1V differential.
- Thermal Regulation is defined as the change in output voltage at a time t after a change in power dissipation is applied, excluding load or line regulation effects. Specifications are for a current pulse equal to I_{LMAX} at $V_{IN} = 6V$ for $t = 10 \text{ msec}$.
- The maximum allowable power dissipation is a function of ambient temperature, the maximum allowable junction temperature and the thermal resistance from junction-to-air (i.e. T_A , T_J , θ_{JA}). Exceeding the maximum allowable power dissipation causes the device to initiate thermal shutdown. Please see Section 4.0, "Thermal Considerations", of this data sheet for more details.
- The minimum V_{IN} has to meet two conditions: $V_{IN} \geq 2.7V$ and $V_{IN} \geq (V_R + V_{DROPOUT})$.
- The junction temperature of the device is approximated by soaking the device under test at an ambient temperature equal to the desired junction temperature. The test time is small enough such that the rise in the junction temperature over the ambient temperature is not significant.

2.0 TYPICAL CHARACTERISTICS

Note: The graphs and tables provided following this note are a statistical summary based on a limited number of samples and are provided for informational purposes only. The performance characteristics listed herein are not tested or guaranteed. In some graphs or tables, the data presented may be outside the specified operating range (e.g., outside specified power supply range) and therefore outside the warranted range.

Junction temperature (T_J) is approximated by soaking the device under test at an ambient temperature equal to the desired Junction temperature. The test time is small enough such that the rise in the Junction temperature over the Ambient temperature is not significant.

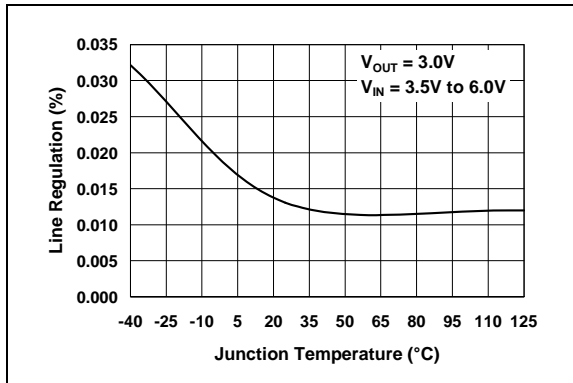

FIGURE 2-1: Line Regulation vs. Temperature.

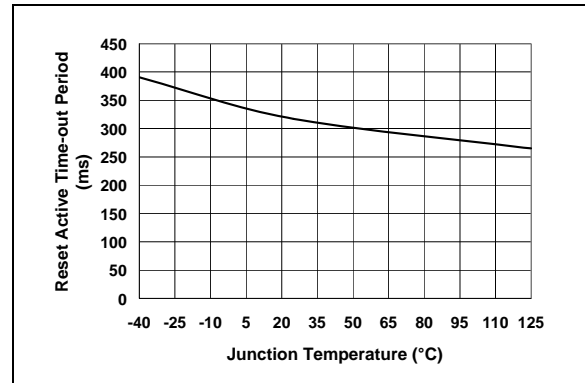

FIGURE 2-4: Reset Active Time-out Period vs. Temperature.

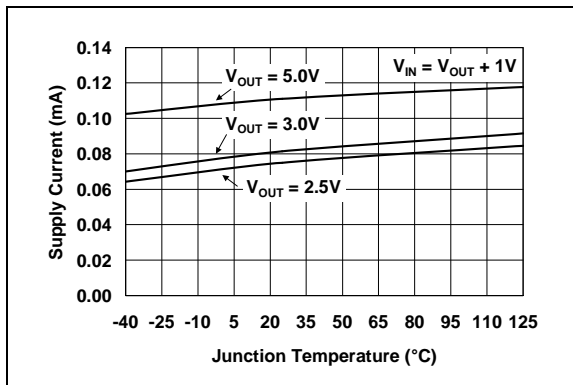

FIGURE 2-2: Supply Current vs. Temperature.

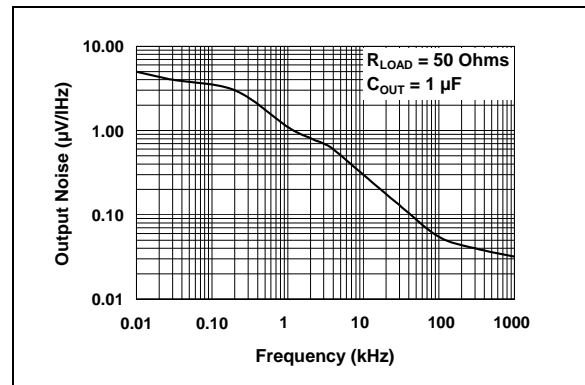

FIGURE 2-5: Output Noise vs. Frequency.

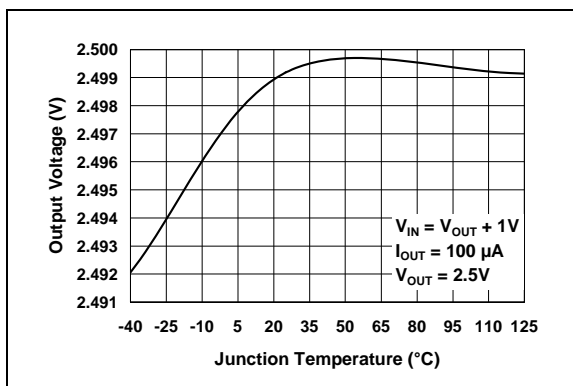

FIGURE 2-3: Normalized V_{OUT} vs. Temperature.

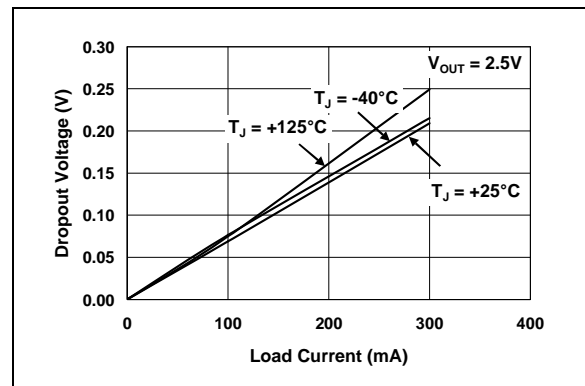

FIGURE 2-6: Dropout Voltage vs. Load Current (2.5V).

2.0 TYPICAL CHARACTERISTICS (CON'T)

Junction temperature (T_J) is approximated by soaking the device under test at an ambient temperature equal to the desired Junction temperature. The test time is small enough such that the rise in the Junction temperature over the Ambient temperature is not significant.

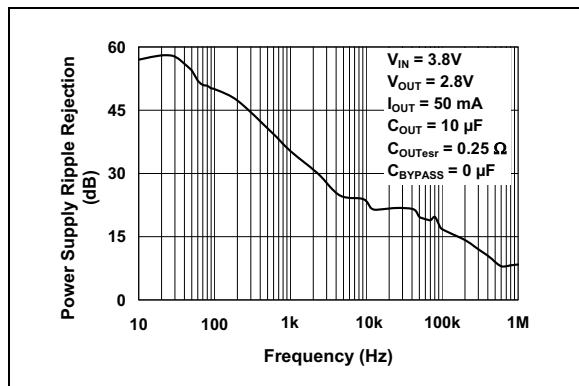

FIGURE 2-7: Power Supply Rejection Ratio vs. Frequency.

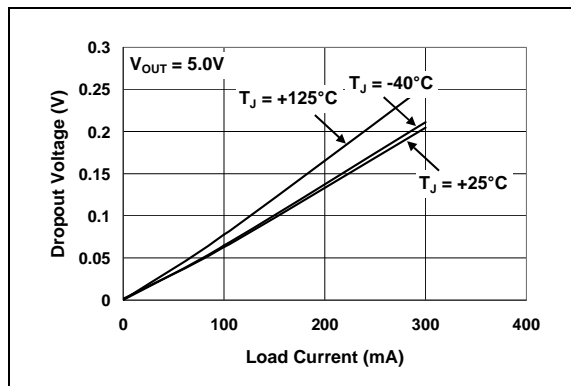

FIGURE 2-10: Dropout Voltage vs. Load Current (5.0V).

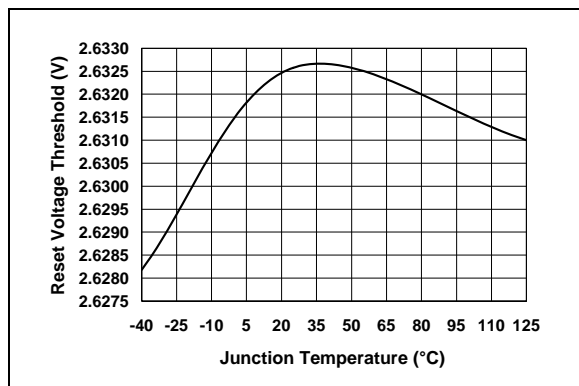

FIGURE 2-8: Reset Voltage Threshold vs. Junction Temperature.

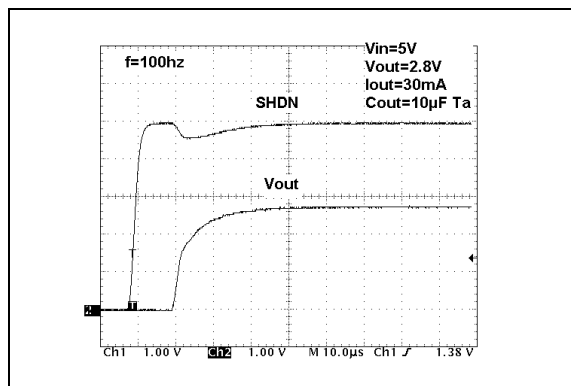

FIGURE 2-11: Wake-Up Response Time.

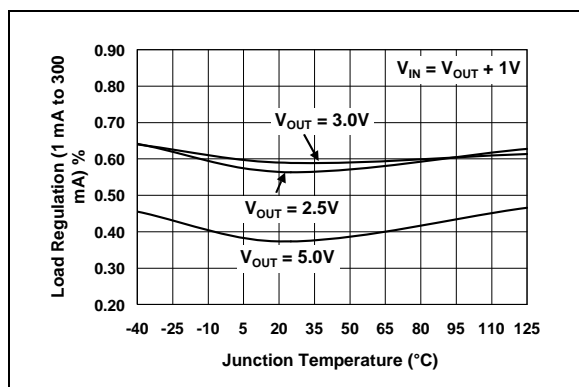

FIGURE 2-9: Load Regulation vs. Temperature.

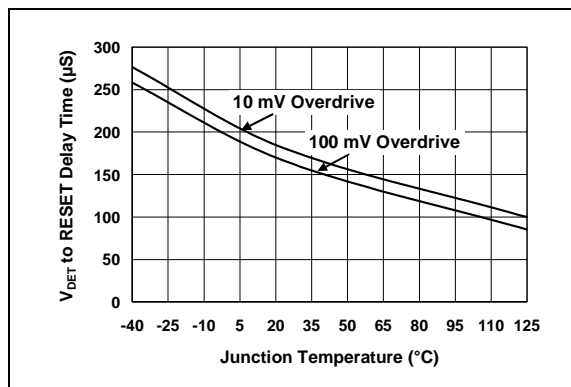

FIGURE 2-12: V_{DET} to Reset Delay vs. Temperature.

2.0 TYPICAL CHARACTERISTICS (CON'T)

Junction temperature (T_J) is approximated by soaking the device under test at an ambient temperature equal to the desired Junction temperature. The test time is small enough such that the rise in the Junction temperature over the Ambient temperature is not significant.

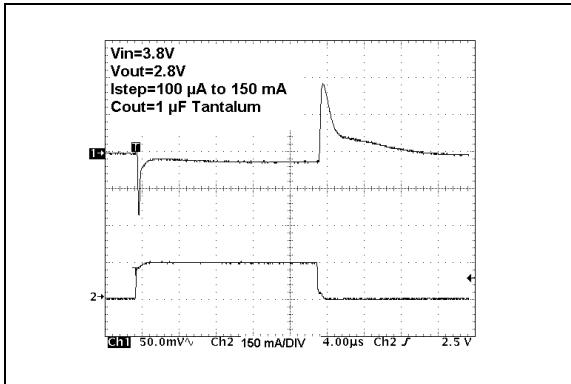

FIGURE 2-13: Load Transient Response
1 μ F Output Capacitor.

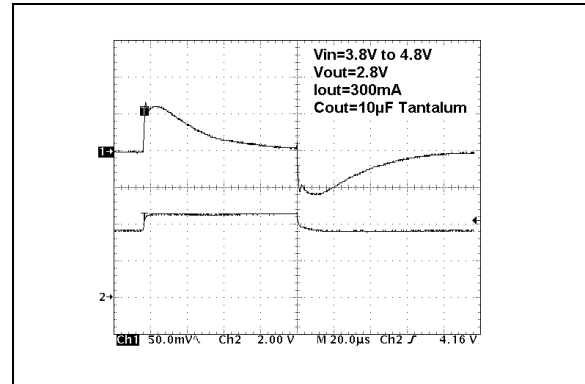

FIGURE 2-16: Line Transient Response
10 μ F Output Capacitor.

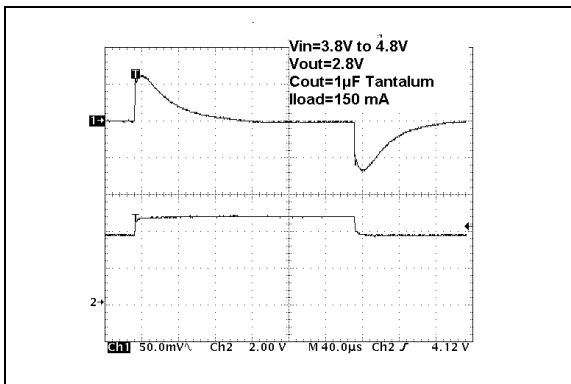

FIGURE 2-14: Line Transient Response
1 μ F Output Capacitor.

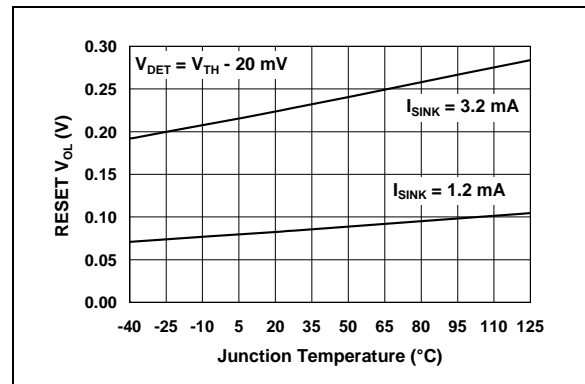

FIGURE 2-17: RESET Output Voltage Low
vs. Junction Temperature.

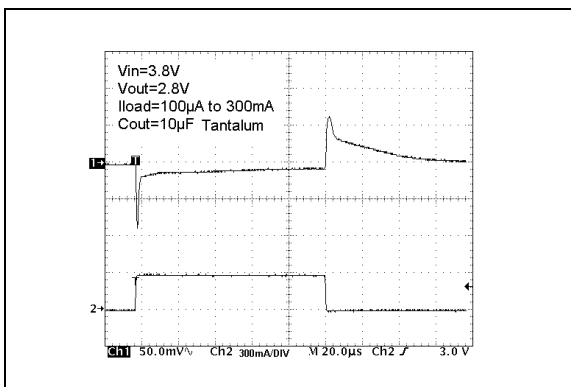

FIGURE 2-15: Load Transient Response
10 μ F Output Capacitor.

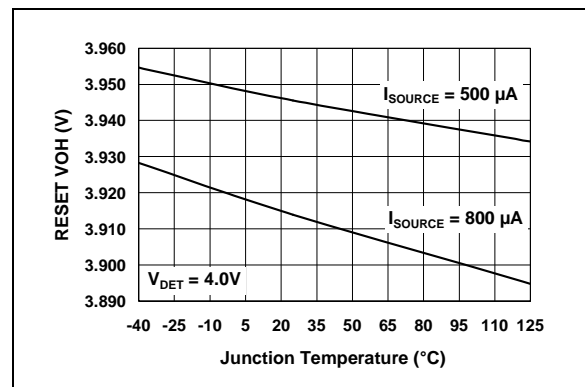

FIGURE 2-18: RESET Output Voltage High
vs. Junction Temperature.

3.0 DETAILED DESCRIPTION

The TC1300 is a combination of a fixed output, low dropout regulator and a microcontroller monitor/RESET. Unlike bipolar regulators, the TC1300 supply current does not increase with load current. In addition, V_{OUT} remains stable and within regulation over the entire specified operating load range (0 mA to 300 mA) and operating input voltage range (2.7V to 6.0V).

Figure 3-1 shows a typical application circuit. The regulator is enabled any time the shutdown input (SHDN) is above V_{IH} . The regulator is shutdown (disabled) when SHDN is at or below V_{IL} . SHDN may be controlled by a CMOS logic gate or an I/O port of a microcontroller. If the SHDN input is not required, it should be connected directly to the input supply. While in shutdown, supply current decreases to 30 μ A (typical), V_{OUT} falls to zero and RESET remains valid.

3.1 RESET Output

The RESET output is driven active-low within 160 μ sec of V_{DET} falling through the reset voltage threshold. RESET is maintained active for a minimum of 140 msec after V_{DET} rises above the reset threshold. The TC1300 has an active-low RESET output. The output of the TC1300 is valid down to $V_{DET} = 1V$ and is optimized to reject fast transient glitches on the V_{DET} line.

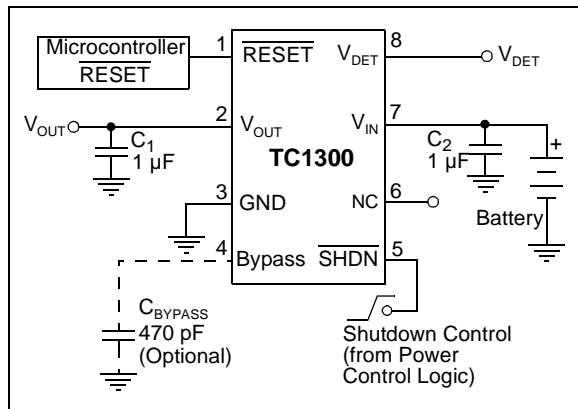

FIGURE 3-1: Typical Application Circuit.

3.2 Output Capacitor

A 1 μ F (min) capacitor from V_{OUT} to ground is required. A 1 μ F capacitor should also be connected from V_{IN} to GND if there is more than 10 inches of wire between the regulator and the AC filter capacitor, or if a battery is used as the power source. As with all low dropout regulators, a minimum output capacitance is required to stabilize the output voltage. For the TC1300, a minimum of 1 μ F of output capacitance is enough to stabilize the device over the entire operating load and line range. The selected output capacitor plays an important role in compensating the LDO regulator. For the

TC1300, the selected output capacitor equivalent series resistance (ESR) range is 0.1 ohms to 5 ohms when using 1 μ F of output capacitance, and 0.01 ohms to 5 ohms when using 10 μ F of output capacitance. Because of the ESR requirement, tantalum and aluminum electrolytic capacitors are recommended. Aluminum electrolytic capacitors are not recommended for operation at temperatures below -25°C. When operating from sources other than batteries, rejection and transient responses can be improved by increasing the value of the input and output capacitors and employing passive filtering techniques.

3.3 Bypass Input (Optional)

An optional 470 pF capacitor connected from the Bypass input to ground reduces noise present on the internal reference, which in turn significantly reduces output noise and improves PSRR performance. This input may be left unconnected. Larger capacitor values may be used, but results in a longer time period to rated output voltage when power is initially applied.

3.4 Turn On Response

The turn-on response is defined as two separate response categories, Wake-Up Time (t_{WK}) and Settling Time (t_s).

The TC1300 has a fast Wake-Up Time (10 μ sec typical) when released from shutdown. See Figure 3-2 for the Wake-Up Time designated as t_{WK} . The Wake-Up Time is defined as the time it takes for the output to rise to 2% of the V_{OUT} value after being released from shutdown.

The total turn-on response is defined as the Settling Time (t_s) (see Figure 3-2). Settling Time (inclusive with t_{WK}) is defined as the condition when the output is within 2% of its fully enabled value (50 μ sec typical) when released from shutdown. The settling time of the output voltage is dependent on load conditions and output capacitance on V_{OUT} (RC response).

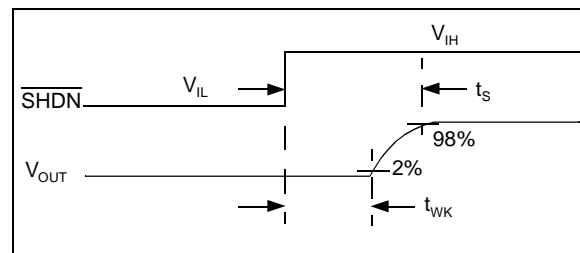

FIGURE 3-2: Wake-Up Response Time.

4.0 THERMAL CONSIDERATIONS

4.1 Thermal Shutdown

Integrated thermal protection circuitry shuts the regulator off when the die temperature exceeds 150°C. The regulator remains off until the die temperature drops to approximately 140°C.

4.2 Power Dissipation

The amount of power the regulator dissipates is primarily a function of input and output voltage, and output current. The following equation is used to calculate worst case *actual* power dissipation:

EQUATION

$$P_D \approx (V_{INMAX} - V_{OUTMIN})I_{LOADMAX}$$

Where:

P_D = worst case actual power dissipation
 V_{INMAX} = maximum voltage on V_{IN}
 V_{OUTMIN} = minimum regulator output voltage
 $I_{LOADMAX}$ = maximum output (load) current

The maximum allowable power dissipation, P_{DMAX} , is a function of the maximum ambient temperature (T_{AMAX}), the maximum recommended die temperature (125°C) and the thermal resistance from junction-to-air (θ_{JA}). The MSOP-8 package has a θ_{JA} of approximately 200°C/Watt when mounted on a FR4 dielectric copper clad PC board.

EQUATION

$$P_{DMAX} = \frac{(T_{JMAX} - T_{AMAX})}{\theta_{JA}}$$

The worst case actual power dissipation equation can be used in conjunction with the LDO maximum allowable power dissipation equation to ensure regulator thermal operation is within limits. For example:

Given:

$$\begin{aligned} V_{INMAX} &= 4.1V \\ V_{OUTMIN} &= 3.0V - 2.5\% \\ I_{LOADMAX} &= 200 \text{ mA} \\ T_{JMAX} &= 125^\circ\text{C} \\ T_{AMAX} &= 55^\circ\text{C} \\ \theta_{JA} &= 200^\circ\text{C/W} \end{aligned}$$

Find:

EQUATION: ACTUAL POWER DISSIPATION

$$\begin{aligned} P_D &\approx (V_{INMAX} - V_{OUTMIN})I_{LOADMAX} \\ &= [(4.1) - (3.0 \times .975)]200 \times 10^{-3} \\ &= 220 \text{ mW} \end{aligned}$$

EQUATION: MAXIMUM ALLOWABLE POWER DISSIPATION

$$\begin{aligned} P_{DMAX} &= \frac{(T_{JMAX} - T_{AMAX})}{\theta_{JA}} \\ &= \frac{(125 - 55)}{200} \\ &= 350 \text{ mW} \end{aligned}$$

In this example, the TC1300 dissipates a maximum of only 220 mW; below the allowable limit of 350 mW. In a similar manner, the maximum actual power dissipation equation and the maximum allowable power dissipation equation can be used to calculate maximum current and/or input voltage limits. For example, the maximum allowable V_{IN} is found by substituting the maximum allowable power dissipation of 350 mW into the actual power dissipation equation, from which $V_{INMAX} = 4.97V$.

4.3 Layout Considerations

The primary path of heat conduction out of the package is via the package leads. Therefore, layouts having a ground plane, wide traces at the pads and wide power supply bus lines combine to lower θ_{JA} and, therefore, increase the maximum allowable power dissipation limit.

TC1300

5.0 PACKAGING INFORMATION

5.1 Package Marking Information

8-Lead MSOP

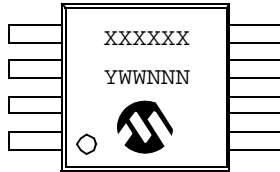

Example:

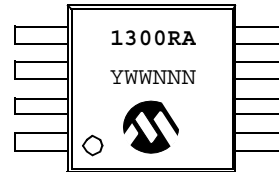

Part Number	Marking Code (XXXXXX)
TC1300R - 2.5VUA	1300RA
TC1300Y - 2.7VUA	1300YF
TC1300R - 2.8VUA	1300RB
TC1300R - 2.85VUA	1300RC
TC1300R - 3.0VUA	1300RD
TC1300R - 3.3VUA	1300RE

Legend:	XX...X	Customer-specific information
	Y	Year code (last digit of calendar year)
	YY	Year code (last 2 digits of calendar year)
	WW	Week code (week of January 1 is week '01')
	NNN	Alphanumeric traceability code
	(e3)	Pb-free JEDEC designator for Matte Tin (Sn)
	*	This package is Pb-free. The Pb-free JEDEC designator (e3) can be found on the outer packaging for this package.

Note: In the event the full Microchip part number cannot be marked on one line, it will be carried over to the next line, thus limiting the number of available characters for customer-specific information.

5.2 Package Dimensions

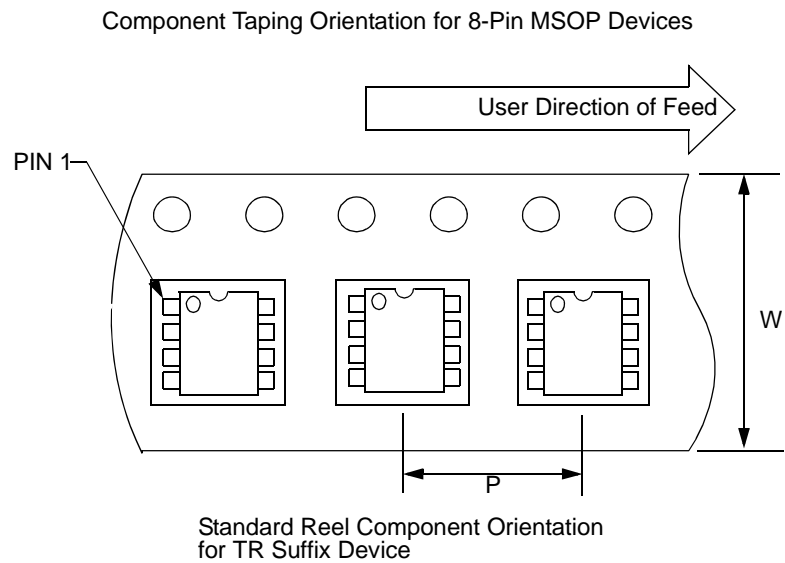

Carrier Tape, Number of Components Per Reel and Reel Size:

Package	Carrier Width (W)	Pitch (P)	Part Per Full Reel	Reel Size
8-Pin MSOP	12 mm	8 mm	2500	13 in.

TC1300

8-Lead Plastic Micro Small Outline Package (UA) (MSOP)

Note: For the most current package drawings, please see the Microchip Packaging Specification located at <http://www.microchip.com/packaging>

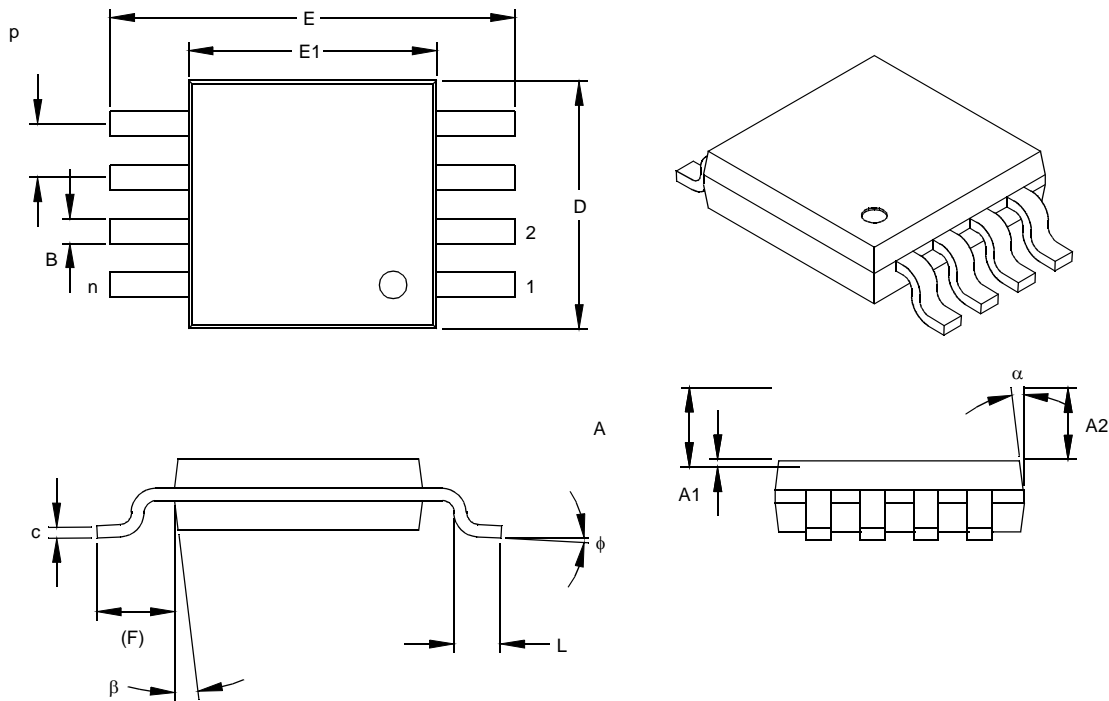

Dimension Limits	Units	INCHES			MILLIMETERS*		
		MIN	NOM	MAX	MIN	NOM	MAX
Number of Pins	n		8				8
Pitch	P	.026			0.65		
Overall Height	A			.044			1.18
Molded Package Thickness	A2	.030	.034	.038	0.76	0.86	0.97
Standoff §	A1	.002		.006	0.05		0.15
Overall Width	E	.184	.193	.200	4.67	4.90	5.08
Molded Package Width	E1	.114	.118	.122	2.90	3.00	3.10
Overall Length	D	.114	.118	.122	2.90	3.00	3.10
Foot Length	L	.016	.022	.028	0.40	0.55	0.70
Footprint (Reference)	F	.035	.037	.039	0.90	0.95	1.00
Foot Angle	φ	0		6	0		6
Lead Thickness	c	.004	.006	.008	0.10	0.15	0.20
Lead Width	B	.010	.012	.016	0.25	0.30	0.40
Mold Draft Angle Top	α		7			7	
Mold Draft Angle Bottom	β		7			7	

*Controlling Parameter
§ Significant Characteristic

Notes:

Dimensions D and E1 do not include mold flash or protrusions. Mold flash or protrusions shall not exceed .010" (0.254mm) per side.

Drawing No. C04-111

6.0 REVISION HISTORY

Revision D (November 2010)

Added a note to each package outline drawing.

TC1300

NOTES:

PRODUCT IDENTIFICATION SYSTEM

To order or obtain information, e.g., on pricing or delivery, refer to the factory or the listed sales office.

<u>PART NO.</u>	<u>-X.X</u>	<u>X</u>	<u>/XX</u>
Device	Output Voltages	Temperature Range	Package
Device:	TC1300X-X.XXXX:	300mA CMOS LDO w/Shutdown, Bypass & Independent Delayed Reset	
	TC1300X-X.XXXXTR:	300mA CMOS LDO w/Shutdown, Bypass & Independent Delayed Reset (Tape and Reel)	
Output Voltages:	2.5V = 2.5		
	2.7V = 2.7		
RESET Threshold Voltages:	2.8V = 2.8		
- 2.4V = Y	2.85V = 2.85		
- 2.63V = R	3.0V = 3.0		
	3.3V = 3.3		
Temperature Range:	V = -40°C to +125°C		
Package:	UA = Micro Small Outline Package (MSOP), 8-lead		

Examples:

- a) TC1300R-2.5VUA: 300mA CMOS LDO w/ Shutdown, Bypass & Independent Delayed Reset, 2.5V output voltage, 2.63V RESET Threshold.
- b) TC1300R-2.8VUA: 300mA CMOS LDO w/Shutdown, Bypass & Independent Delayed Reset, 2.8V output voltage, 2.63V RESET Threshold.
- c) TC1300R-2.85VUA: 300mA CMOS LDO w/ Shutdown, Bypass & Independent Delayed Reset, 2.85V output voltage, 2.63V RESET Threshold.
- d) TC1300R-3.0VUA: 300mA CMOS LDO w/Shutdown, Bypass & Independent Delayed Reset, 3.0V output voltage, 2.63V RESET Threshold.
- e) TC1300R-3.3VUA: 300mA CMOS LDO w/Shutdown, Bypass & Independent Delayed Reset, 3.3V output voltage, 2.63V RESET Threshold.
- f) TC1300R-2.85VUATR: 300mA CMOS LDO w/ Shutdown, Bypass & Independent Delayed Reset, 2.85V output voltage, 2.63V RESET Threshold, tape and reel.
- g) TC1300Y-2.7VUA: 300mA CMOS LDO w/ Shutdown, Bypass & independent Delayed Reset, 2.7V output voltage, 2.4V RESET Threshold.

Sales and Support

Data Sheets

Products supported by a preliminary Data Sheet may have an errata sheet describing minor operational differences and recommended workarounds. To determine if an errata sheet exists for a particular device, please contact one of the following:

1. Your local Microchip sales office
2. The Microchip Worldwide Site (www.microchip.com)

Please specify which device, revision of silicon and Data Sheet (include Literature #) you are using.

New Customer Notification System

Register on our web site (www.microchip.com/cn) to receive the most current information on our products.

TC1300

NOTES:

Note the following details of the code protection feature on Microchip devices:

- Microchip products meet the specification contained in their particular Microchip Data Sheet.
- Microchip believes that its family of products is one of the most secure families of its kind on the market today, when used in the intended manner and under normal conditions.
- There are dishonest and possibly illegal methods used to breach the code protection feature. All of these methods, to our knowledge, require using the Microchip products in a manner outside the operating specifications contained in Microchip's Data Sheets. Most likely, the person doing so is engaged in theft of intellectual property.
- Microchip is willing to work with the customer who is concerned about the integrity of their code.
- Neither Microchip nor any other semiconductor manufacturer can guarantee the security of their code. Code protection does not mean that we are guaranteeing the product as “unbreakable.”

Code protection is constantly evolving. We at Microchip are committed to continuously improving the code protection features of our products. Attempts to break Microchip's code protection feature may be a violation of the Digital Millennium Copyright Act. If such acts allow unauthorized access to your software or other copyrighted work, you may have a right to sue for relief under that Act.

Information contained in this publication regarding device applications and the like is provided only for your convenience and may be superseded by updates. It is your responsibility to ensure that your application meets with your specifications. MICROCHIP MAKES NO REPRESENTATIONS OR WARRANTIES OF ANY KIND WHETHER EXPRESS OR IMPLIED, WRITTEN OR ORAL, STATUTORY OR OTHERWISE, RELATED TO THE INFORMATION, INCLUDING BUT NOT LIMITED TO ITS CONDITION, QUALITY, PERFORMANCE, MERCHANTABILITY OR FITNESS FOR PURPOSE. Microchip disclaims all liability arising from this information and its use. Use of Microchip devices in life support and/or safety applications is entirely at the buyer's risk, and the buyer agrees to defend, indemnify and hold harmless Microchip from any and all damages, claims, suits, or expenses resulting from such use. No licenses are conveyed, implicitly or otherwise, under any Microchip intellectual property rights.

Trademarks

The Microchip name and logo, the Microchip logo, dsPIC, FlashFlex, KEELOQ, KEELOQ logo, MPLAB, PIC, PICmicro, PICSTART, PIC³² logo, rPIC, SST, SST Logo, SuperFlash and UNI/O are registered trademarks of Microchip Technology Incorporated in the U.S.A. and other countries.

FilterLab, Hampshire, HI-TECH C, Linear Active Thermistor, MTP, SEEVAL and The Embedded Control Solutions Company are registered trademarks of Microchip Technology Incorporated in the U.S.A.

Silicon Storage Technology is a registered trademark of Microchip Technology Inc. in other countries.

Analog-for-the-Digital Age, Application Maestro, BodyCom, chipKIT, chipKIT logo, CodeGuard, dsPICDEM, dsPICDEM.net, dsPICworks, dsSPEAK, ECAN, ECONOMONITOR, FanSense, HI-TIDE, In-Circuit Serial Programming, ICSP, Mindi, MiWi, MPASM, MPF, MPLAB Certified logo, MPLIB, MPLINK, mTouch, Omniclient Code Generation, PICC, PICC-18, PICDEM, PICDEM.net, PICkit, PICtail, REAL ICE, rLAB, Select Mode, SQI, Serial Quad I/O, Total Endurance, TSHARC, UniWinDriver, WiperLock, ZENA and Z-Scale are trademarks of Microchip Technology Incorporated in the U.S.A. and other countries.

SQTP is a service mark of Microchip Technology Incorporated in the U.S.A.

GestIC and ULPP are registered trademarks of Microchip Technology Germany II GmbH & Co. & KG, a subsidiary of Microchip Technology Inc., in other countries.

All other trademarks mentioned herein are property of their respective companies.

© 2001-2012, Microchip Technology Incorporated, Printed in the U.S.A., All Rights Reserved.

 Printed on recycled paper.

ISBN: 9781620767832

QUALITY MANAGEMENT SYSTEM
CERTIFIED BY DNV
== ISO/TS 16949 ==

Microchip received ISO/TS-16949:2009 certification for its worldwide headquarters, design and wafer fabrication facilities in Chandler and Tempe, Arizona; Gresham, Oregon and design centers in California and India. The Company's quality system processes and procedures are for its PIC[®] MCUs and dsPIC[®] DSCs, KEELOQ[®] code hopping devices, Serial EEPROMs, microperipherals, nonvolatile memory and analog products. In addition, Microchip's quality system for the design and manufacture of development systems is ISO 9001:2000 certified.



MICROCHIP

Worldwide Sales and Service

AMERICAS

Corporate Office
2355 West Chandler Blvd.
Chandler, AZ 85224-6199
Tel: 480-792-7200
Fax: 480-792-7277
Technical Support:
<http://www.microchip.com/support>
Web Address:
www.microchip.com

Atlanta
Duluth, GA
Tel: 678-957-9614
Fax: 678-957-1455

Boston
Westborough, MA
Tel: 774-760-0087
Fax: 774-760-0088

Chicago
Itasca, IL
Tel: 630-285-0071
Fax: 630-285-0075

Cleveland
Independence, OH
Tel: 216-447-0464
Fax: 216-447-0643

Dallas
Addison, TX
Tel: 972-818-7423
Fax: 972-818-2924

Detroit
Farmington Hills, MI
Tel: 248-538-2250
Fax: 248-538-2260

Indianapolis
Noblesville, IN
Tel: 317-773-8323
Fax: 317-773-5453

Los Angeles
Mission Viejo, CA
Tel: 949-462-9523
Fax: 949-462-9608

Santa Clara
Santa Clara, CA
Tel: 408-961-6444
Fax: 408-961-6445

Toronto
Mississauga, Ontario,
Canada
Tel: 905-673-0699
Fax: 905-673-6509

ASIA/PACIFIC

Asia Pacific Office
Suites 3707-14, 37th Floor
Tower 6, The Gateway
Harbour City, Kowloon
Hong Kong
Tel: 852-2401-1200
Fax: 852-2401-3431

Australia - Sydney
Tel: 61-2-9868-6733
Fax: 61-2-9868-6755

China - Beijing
Tel: 86-10-8569-7000
Fax: 86-10-8528-2104

China - Chengdu
Tel: 86-28-8665-5511
Fax: 86-28-8665-7889

China - Chongqing
Tel: 86-23-8980-9588
Fax: 86-23-8980-9500

China - Hangzhou
Tel: 86-571-2819-3187
Fax: 86-571-2819-3189

China - Hong Kong SAR
Tel: 852-2943-5100
Fax: 852-2401-3431

China - Nanjing
Tel: 86-25-8473-2460
Fax: 86-25-8473-2470

China - Qingdao
Tel: 86-532-8502-7355
Fax: 86-532-8502-7205

China - Shanghai
Tel: 86-21-5407-5533
Fax: 86-21-5407-5066

China - Shenyang
Tel: 86-24-2334-2829
Fax: 86-24-2334-2393

China - Shenzhen
Tel: 86-755-8864-2200
Fax: 86-755-8203-1760

China - Wuhan
Tel: 86-27-5980-5300
Fax: 86-27-5980-5118

China - Xian
Tel: 86-29-8833-7252
Fax: 86-29-8833-7256

China - Xiamen
Tel: 86-592-2388138
Fax: 86-592-2388130

China - Zhuhai
Tel: 86-756-3210040
Fax: 86-756-3210049

ASIA/PACIFIC

India - Bangalore
Tel: 91-80-3090-4444
Fax: 91-80-3090-4123

India - New Delhi
Tel: 91-11-4160-8631
Fax: 91-11-4160-8632

India - Pune
Tel: 91-20-2566-1512
Fax: 91-20-2566-1513

Japan - Osaka
Tel: 81-66-152-7160
Fax: 81-66-152-9310

Japan - Yokohama
Tel: 81-45-471-6166
Fax: 81-45-471-6122

Korea - Daegu
Tel: 82-53-744-4301
Fax: 82-53-744-4302

Korea - Seoul
Tel: 82-2-554-7200
Fax: 82-2-558-5932 or
82-2-558-5934

Malaysia - Kuala Lumpur
Tel: 60-3-6201-9857
Fax: 60-3-6201-9859

Malaysia - Penang
Tel: 60-4-227-8870
Fax: 60-4-227-4068

Philippines - Manila
Tel: 63-2-634-9065
Fax: 63-2-634-9069

Singapore
Tel: 65-6334-8870
Fax: 65-6334-8850

Taiwan - Hsin Chu
Tel: 886-3-5778-366
Fax: 886-3-5770-955

Taiwan - Kaohsiung
Tel: 886-7-213-7828
Fax: 886-7-330-9305

Taiwan - Taipei
Tel: 886-2-2508-8600
Fax: 886-2-2508-0102

Thailand - Bangkok
Tel: 66-2-694-1351
Fax: 66-2-694-1350

EUROPE

Austria - Wels
Tel: 43-7242-2244-39
Fax: 43-7242-2244-393

Denmark - Copenhagen
Tel: 45-4450-2828
Fax: 45-4485-2829

France - Paris
Tel: 33-1-69-53-63-20
Fax: 33-1-69-30-90-79

Germany - Munich
Tel: 49-89-627-144-0
Fax: 49-89-627-144-44

Italy - Milan
Tel: 39-0331-742611
Fax: 39-0331-466781

Netherlands - Drunen
Tel: 31-416-690399
Fax: 31-416-690340

Spain - Madrid
Tel: 34-91-708-08-90
Fax: 34-91-708-08-91

UK - Wokingham
Tel: 44-118-921-5869
Fax: 44-118-921-5820

11/27/12



Компания «ЭлектроПласт» предлагает заключение долгосрочных отношений при поставках импортных электронных компонентов на взаимовыгодных условиях!

Наши преимущества:

- Оперативные поставки широкого спектра электронных компонентов отечественного и импортного производства напрямую от производителей и с крупнейших мировых складов;
- Поставка более 17-ти миллионов наименований электронных компонентов;
- Поставка сложных, дефицитных, либо снятых с производства позиций;
- Оперативные сроки поставки под заказ (от 5 рабочих дней);
- Экспресс доставка в любую точку России;
- Техническая поддержка проекта, помощь в подборе аналогов, поставка прототипов;
- Система менеджмента качества сертифицирована по Международному стандарту ISO 9001;
- Лицензия ФСБ на осуществление работ с использованием сведений, составляющих государственную тайну;
- Поставка специализированных компонентов (Xilinx, Altera, Analog Devices, Intersil, Interpoint, Microsemi, Aeroflex, Peregrine, Syfer, Eurofarad, Texas Instrument, Miteq, Cobham, E2V, MA-COM, Hittite, Mini-Circuits, General Dynamics и др.);

Помимо этого, одним из направлений компании «ЭлектроПласт» является направление «Источники питания». Мы предлагаем Вам помощь Конструкторского отдела:

- Подбор оптимального решения, техническое обоснование при выборе компонента;
- Подбор аналогов;
- Консультации по применению компонента;
- Поставка образцов и прототипов;
- Техническая поддержка проекта;
- Защита от снятия компонента с производства.



Как с нами связаться

Телефон: 8 (812) 309 58 32 (многоканальный)

Факс: 8 (812) 320-02-42

Электронная почта: org@eplast1.ru

Адрес: 198099, г. Санкт-Петербург, ул. Калинина, дом 2, корпус 4, литера А.