

CUBEFuse™ and Fuseholder

Finger-Safe Dual-Element Time-Delay Fuses Indicating – 600 Volts or Less

TCF & TCFH

1-100 Amps



Catalog Symbol: TCF (Fuse) & TCFH (Holder)
 Dual-Element, Time-Delay Fuse: 10 Seconds
 Minimum Operating Time at 500% Rated Current
 Ampere Rating: 1 to 100A
 Voltage Rating: 600Vac (or less)
 Interrupting Rating: 300,000A RMS Symmetrical (UL)
 200,000A RMS Symmetrical (CSA)

Agency Information:

UL Listed Special Purpose Fuse: Guide JFHR,
 File E56412

CSA Certified Fuse: Class 1422- 02, File 53787

UL Listed Fuseholder: Guide IZND,
 File E214079

CSA Certified Fuseholder: Class 6225-01, File 47235

Other Electrical Certifications:

CE compliance for the European Union Low Voltage
 Directive (50-1000Vac, 75-1500Vdc)

DC Voltage Rating: 300Vdc (or less), 100,000AIR

Catalog Numbers

TCF1	TCF3	TCF6	TCF10
TCF15	TCF17-1/2	TCF20	TCF25
TCF30	TCF35	TCF40	TCF45
TCF50	TCF60	TCF70	TCF80
TCF90	TCF100		

CUBEFuse™ Fuseholder Catalog Data

Amps	Poles	Wire *	Dual Wire *	Part Number
30	1	14 AWG to 8 AWG CU	14 AWG CU	TCFH30
60	1	14 AWG to 4 AWG CU	10 AWG to 6 AWG CU	TCFH60
100	1	10 AWG to 1 AWG CU	6 AWG CU	TCFH100

* 75°C (MIN) CU Wire Only

- The world's first finger safe industrial fuse system.
- True dual-element fuse construction with a minimum of 10 seconds time-delay at 500% of rating.
- Long time-delay minimizes nuisance circuit openings due to temporary overloads and transient surges.
- Meets UL Class J Time-Delay electrical performance requirements.
- High interruption rating to safely interrupt faults up to 300,000A.
- Faster response to damaging faults reduces destructive thermal and magnetic forces.
- Permanent open fuse indication.
- Designed to be an internationally accepted and specified world class product.
- Smallest footprint of any power class fuse including Class J, CC, T and RK.
- Meets requirements of IEC 60529 for IP-20 finger safe rating.
- No venting of arc or molten metal and gases during opening.
- Robust cycling and inrush current withstand.
- Low let through currents under fault conditions.
- Provides TYPE 2 "no damage" protection for IEC motors starters when properly sized.
- Low watt loss reduces power consumption and lowers operating temperature.
- Conventional Class J fuse case sizes and ampere ratings.
- Dovetail fuseholder design for ganging multiple fuse poles.
- 30, 60 and 100A fuseholders can be ganged together.
- 30A fuses can be plugged into the 60 and 100A holder without a reducer.
- 60A fuses can be plugged into the 100A holder without a reducer.
- 35mm DIN rail and chassis mounting features.
- Fuseholder wire ports rated for dual wires.

Carton Quantity and Weight

Ampere Rating	Carton Qty	Weight Per Carton	
		Lbs.	Kg.
TCF1-30	12	1.39	.518
TCFH30	12	2.42	.902
TCF35-60	12	1.42	.530
TCFH60	12	2.57	.958
TCF70-100	6	1.74	.791
TCFH100	6	1.38	.626

CUBEFuse™ and Fuseholder

Finger-Safe Dual-Element Time-Delay Fuses

Indicating – 600 Volts or Less

TCF & TCFH

1-100 Amps

Dimensional Data For TCF and TCFH

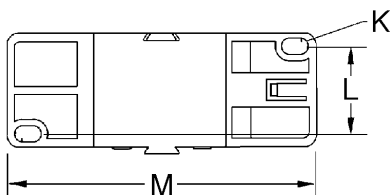
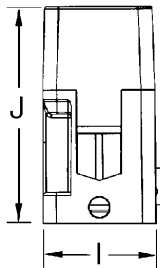
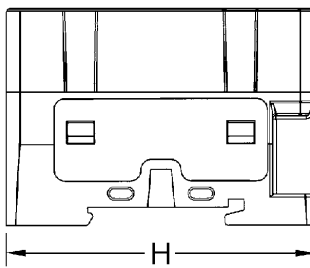
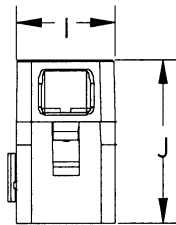
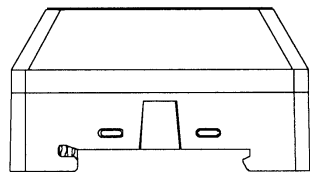
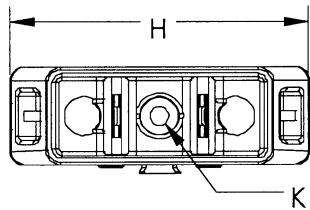
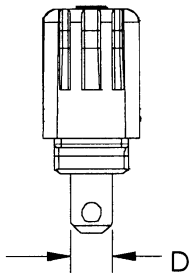
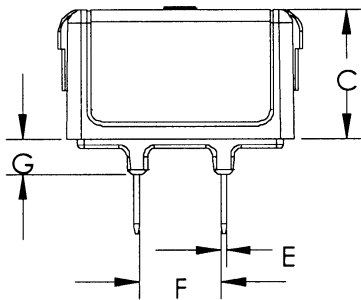
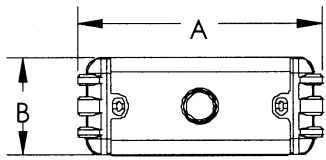

Dimensional Data For TCF and TCFH

Dimension	30A in [mm]	60A in [mm]	100A in [mm]
A	1.88 [47.75]	2.13 [54.10]	3.01 [76.45]
B	.75 [19.05]	1.00 [25.40]	1.00 [25.40]
C	1.00 [25.40]	1.13 [28.58]	1.26 [32.00]
D	.31 [7.94]	.44 [11.11]	.57 [14.48]
E	.04 [1.02]	.04 [1.02]	.06 [1.60]
F	.63 [15.88]	.63 [15.88]	.63 [15.88]
G	.27 [6.86]	.38 [9.65]	.39 [9.93]
H	2.30 [58.42]	2.60 [66.04]	2.91 [73.91]
I	.76 [19.30]	1.03 [26.16]	1.05 [26.75]
J	1.27 [32.18]	1.53 [38.86]	2.01 [51.05]
K	.15 [3.81]	.17 [4.32]	.160 [4.06]
L	N/A	N/A	.80 [20.32]
M	N/A	N/A	2.51 [63.75]

CUBEFuse™ and Fuseholder

Finger-Safe Dual-Element Time-Delay Fuses

Indicating - 600 Volts or Less

TCF & TCFH
1-100 Amps

Time-Current Characteristic Curves-Average Melt

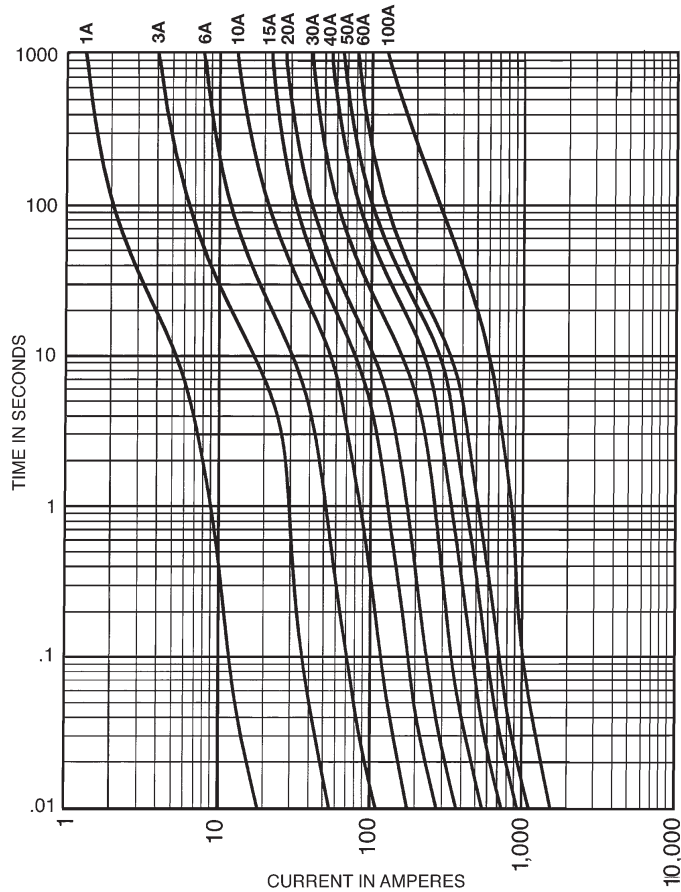

Current Limitation Curves

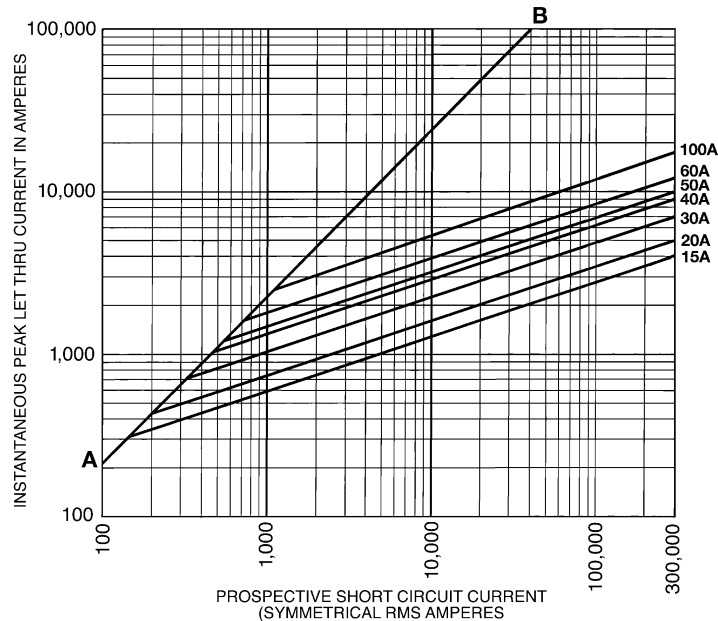

CUBEFuse™ and Fuseholder

Finger-Safe Dual-Element Time-Delay Fuses

Indicating – 600 Volts or Less

TCF & TCFH

1-100 Amps

ELECTRICAL SPECIFICATIONS

Maximum operating voltage: 600Vac (300Vdc)
 Maximum interruption current:
 300K A maximum @ 600Vac
 100K A maximum @ 300Vdc
 Watts Loss at rated current:
 TCF30: 3.99W
 TCF60: 6.23W
 TCF100: 9.51W

THERMAL SPECIFICATIONS

Operating temperature range: -10°C to 65°C

MECHANICAL SPECIFICATIONS

Tested continuous harmonic vibration: 0.03" amplitude, 10Hz-60Hz-10Hz 4min excursion, repeated for 4hr, repeated for 3 mutually perpendicular planes (fuse in holder)

Tested impact acceleration: 20g in 3 mutually perpendicular planes

FUSE MODULE MATERIAL SPECIFICATIONS

Fuse case: 20% glass filled PES (Polyethersulfone)
 Fuse terminals: 110 Copper
 Fuse terminal plating: Electroless Tin
 Fusible element: Copper Alloys
 Filler: Pure quartz silica
 Fill plug: Nylon
 Indicator lens: PES (Polyethersulfone)
 Indicator: Energetic chemical

FUSEHOLDER MATERIAL SPECIFICATIONS

Holder case: 15% glass filled PBT (polybutylene terephthalate)
 Interface Clips: High Performance Copper Alloy
 Interface Clip plating: Electroless Tin (*No plating on TCFH100*)
 Contact Lubricant: Fluoroether Grease
 30A Box Lug: Copper
 60A Box Lug: Copper
 100A Box Lug: Aluminum
 DIN Rail Spring: Stainless Steel

HANDLING & STORAGE SPECIFICATIONS

Storage Temperature: -10°C to 65°C



Компания «ЭлектроПласт» предлагает заключение долгосрочных отношений при поставках импортных электронных компонентов на взаимовыгодных условиях!

Наши преимущества:

- Оперативные поставки широкого спектра электронных компонентов отечественного и импортного производства напрямую от производителей и с крупнейших мировых складов;
- Поставка более 17-ти миллионов наименований электронных компонентов;
- Поставка сложных, дефицитных, либо снятых с производства позиций;
- Оперативные сроки поставки под заказ (от 5 рабочих дней);
- Экспресс доставка в любую точку России;
- Техническая поддержка проекта, помощь в подборе аналогов, поставка прототипов;
- Система менеджмента качества сертифицирована по Международному стандарту ISO 9001;
- Лицензия ФСБ на осуществление работ с использованием сведений, составляющих государственную тайну;
- Поставка специализированных компонентов (Xilinx, Altera, Analog Devices, Intersil, Interpoint, Microsemi, Aeroflex, Peregrine, Syfer, Eurofarad, Texas Instrument, Miteq, Cobham, E2V, MA-COM, Hittite, Mini-Circuits, General Dynamics и др.);

Помимо этого, одним из направлений компании «ЭлектроПласт» является направление «Источники питания». Мы предлагаем Вам помощь Конструкторского отдела:

- Подбор оптимального решения, техническое обоснование при выборе компонента;
- Подбор аналогов;
- Консультации по применению компонента;
- Поставка образцов и прототипов;
- Техническая поддержка проекта;
- Защита от снятия компонента с производства.



Как с нами связаться

Телефон: 8 (812) 309 58 32 (многоканальный)

Факс: 8 (812) 320-02-42

Электронная почта: org@eplast1.ru

Адрес: 198099, г. Санкт-Петербург, ул. Калинина, дом 2, корпус 4, литера А.