

CoolMOS™¹⁾ Power MOSFET

ISOPLUS™ - electrically isolated surface to heatsink

Surface Mount Power Device

$$V_{DSS} = 600 \text{ V}$$

$$I_{D25} = 50 \text{ A}$$

$$R_{DS(on) \text{ max}} = 45 \text{ m}\Omega$$

Preliminary data

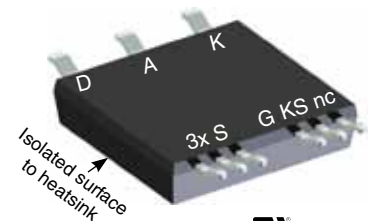
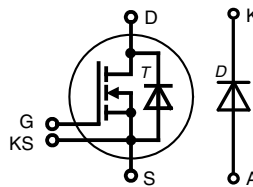

E72873

MOSFET T		Maximum Ratings	
Symbol	Conditions		
V_{DSS}	$T_{VJ} = 25^\circ\text{C to } 150^\circ\text{C}$	600	V
V_{GS}		± 20	V
I_{D25}	$T_C = 25^\circ\text{C}$	50	A
I_{D80}	$T_C = 80^\circ\text{C}$	38	A
E_{AS} E_{AR}	single pulse repetitive } $I_D = 11 \text{ A}; T_C = 25^\circ\text{C}$	1950 3	mJ mJ
dV/dt	MOSFET dV/dt ruggedness $V_{DS} = 0 \dots 480 \text{ V}$	50	V/ns

Symbol	Conditions	Characteristic Values				
		min.	typ.	max.		
($T_{VJ} = 25^\circ\text{C}$, unless otherwise specified)						
$R_{DS(on)}$	$I_D = 44 \text{ A}; V_{GS} = 10 \text{ V}$		40	45	m Ω	
$V_{GS(th)}$	$I_D = 3 \text{ mA}; V_{DS} = V_{GS}$	2.5	3	3.5	V	
I_{DSS}	$V_{DS} = V_{DSS}; V_{GS} = 0 \text{ V}; T_{VJ} = 25^\circ\text{C}$ $T_{VJ} = 125^\circ\text{C}$		50	10	μA μA	
I_{GSS}	$V_{DS} = 0 \text{ V}; V_{GS} = \pm 20 \text{ V}$			100	nA	
$t_{d(on)}$ t_r $t_{d(off)}$ t_f	Inductive switching boost mode with diode D $V_{DS} = 380 \text{ V}; I_D = 30 \text{ A}$ $V_{GS} = 10 \text{ V}; R_G = 33 \Omega$		80		ns	
E_{on}			40		ns	
E_{off}			750		ns	
E_{rec}			40		ns	
C_{iss} C_{oss}	$V_{GS} = 0 \text{ V}; V_{DS} = 100 \text{ V}; f = 1 \text{ MHz}$		6800		pF	
				320		pF
Q_g Q_{gs} Q_{gd}	$V_{DS} = 400 \text{ V}; I_D = 44 \text{ A}$ $V_{GS} = 10 \text{ V}; R_G = 3.3 \Omega$		150	190	nC	
				35		nC
				50		nC
R_{thJC} R_{thJH}	with heatsink compound (IXYS test setup)		0.4		K/W	
			tbd	tbd		K/W

Features

- **Fast CoolMOS™¹⁾** power MOSFET 4th generation
 - high blocking capability
 - lowest resistance
 - avalanche rated for unclamped inductive switching (UIS)
 - low thermal resistance due to reduced chip thickness
- **Package**
 - isolated surface to heatsink
 - low coupling capacity between pins and heatsink
 - PCB space saving
 - enlarged creepage towards heatsink
 - application friendly pinout
 - low inductive current path
 - high reliability

Applications

- Buck / boost chopper
- Optimized for boost configuration
- PFC stage

¹⁾ CoolMOS™ is a trademark of Infineon Technologies AG.

Source-Drain Diode of MOSFET T					
Symbol	Conditions	Maximum Ratings			
I_{S25}	$T_C = 25^\circ\text{C}$	50	A		
I_{S80}	$T_C = 80^\circ\text{C}$	38	A		
Symbol	Conditions	Characteristic Values			
($T_{VJ} = 25^\circ\text{C}$, unless otherwise specified)					
V_{SD}	$I_F = 44\text{ A}; V_{GS} = 0\text{ V}$		0.9	1.0	V
t_{rr}	$I_F = 44\text{ A}; -di_F/dt = 100\text{ A}/\mu\text{s}; V_R = 400\text{ V}$		600		ns
Q_{RM}			17		μC
I_{RM}			60		A

Diode D					
Symbol	Conditions	Maximum Ratings			
I_{F25}	$T_C = 25^\circ\text{C}; \text{DC}$	96	A		
I_{F80}	$T_C = 80^\circ\text{C}; \text{DC}$	61	A		
Symbol	Conditions	Characteristic Values			
($T_{VJ} = 25^\circ\text{C}$, unless otherwise specified)					
V_{RRM}		$T_{VJ} = 25^\circ\text{C}$		600	V
V_F	$I_F = 25\text{ A}$	$T_{VJ} = 25^\circ\text{C}$	1.2	1.4	V
		$T_{VJ} = 125^\circ\text{C}$	1.3		
I_R	$V_R = V_{RRM}$	$T_{VJ} = 25^\circ\text{C}$		150	μA
		$T_{VJ} = 125^\circ\text{C}$	tbd		mA
I_{RM}	$I_F = 30\text{ A}; V_R = 350\text{ V}$ $-di/dt = 240\text{ A}/\mu\text{s}$	$T_{VJ} = 100^\circ\text{C}$	10		A
t_{rr}	$I_F = 1\text{ A}; V_R = 30\text{ V}$ $-di/dt = 100\text{ A}/\mu\text{s}$	$T_{VJ} = 100^\circ\text{C}$	35	50	ns
R_{thJC}	per diode			0.7	K/W
R_{thJH}	with heatsink compound (IXYS test setup)		tbd		k/W

Component					
Symbol	Conditions	Maximum Ratings			
T_{VJ}		-55...+150 °C			
T_{stg}		-55...+125 °C			
V_{ISOL}	$I_{ISOL} \leq 1\text{ mA}; 50/60\text{ Hz}$	2500	V~		
F_C	mounting force	40 ... 130	N		
Symbol	Conditions	Characteristic Values			
C_P	coupling capacity between shorted pins and backside metal		90		pF
d_S, d_A	pin - pin	1.65			mm
d_S, d_A	pin - backside metal	4			mm
CTI		400			
Weight			8		g

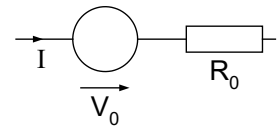
Equivalent Circuits for Simulation
Conduction

Boost Diode (typ. at $T_J = 125^\circ\text{C}$)
 $V_0 = \text{tbd V}; R_0 = \text{tbd m}\Omega$

Ordering	Part Number	Marking on Product	Delivering Mode	Base Qty	Ordering Code
Standard	MKE38RK600DFELB-TRR	MKE38RK600DFELB	Tape & Reel	200	510479
	MKE38RK600DFELB	MKE38RK600DFELB	Blister	45	510231

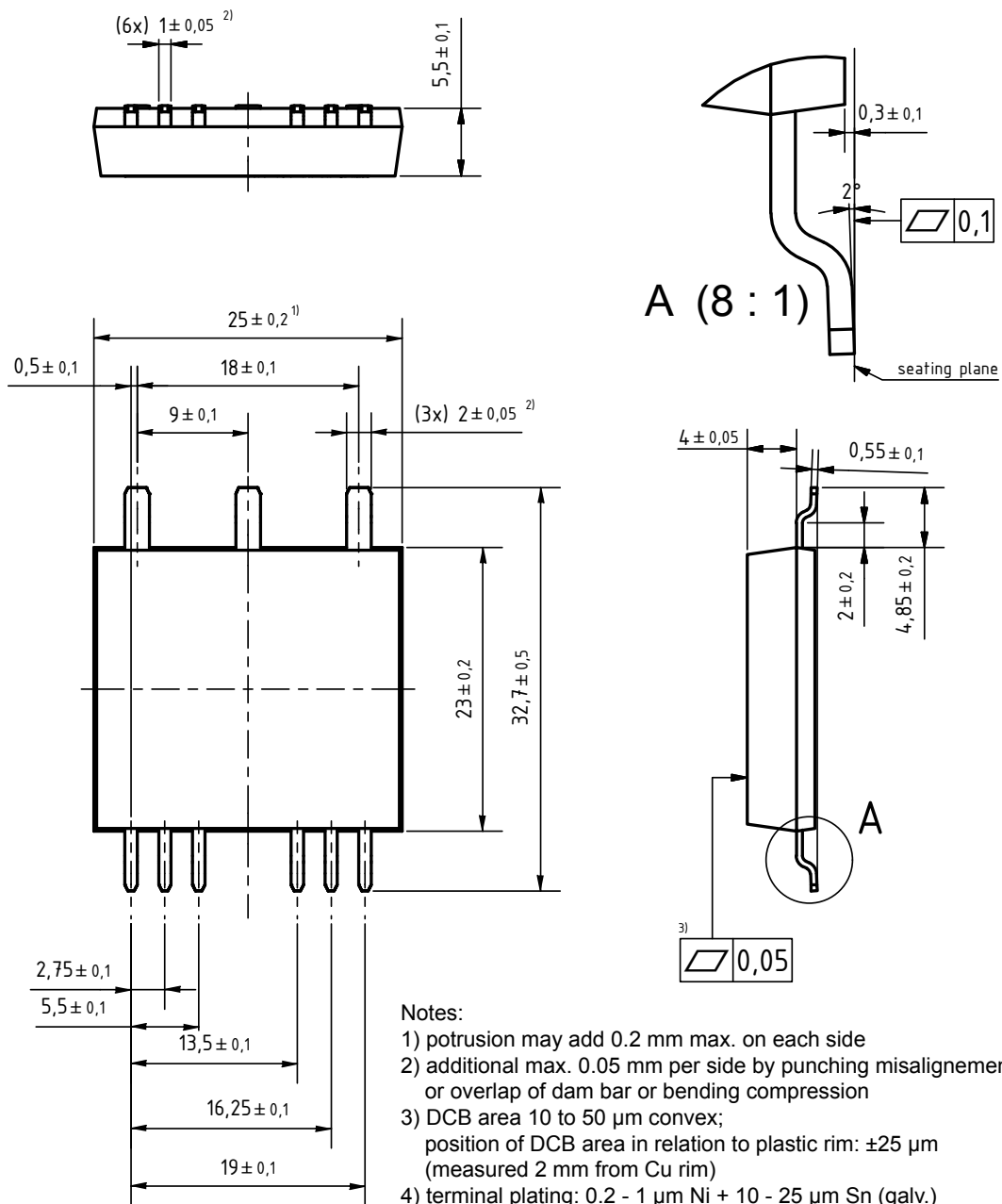

- Notes:
- 1) protrusion may add 0.2 mm max. on each side
 - 2) additional max. 0.05 mm per side by punching misalignment or overlap of dam bar or bending compression
 - 3) DCB area 10 to 50 μ m convex; position of DCB area in relation to plastic rim: $\pm 25 \mu$ m (measured 2 mm from Cu rim)
 - 4) terminal plating: 0.2 - 1 μ m Ni + 10 - 25 μ m Sn (galv.) cutting edges may be partially free of plating

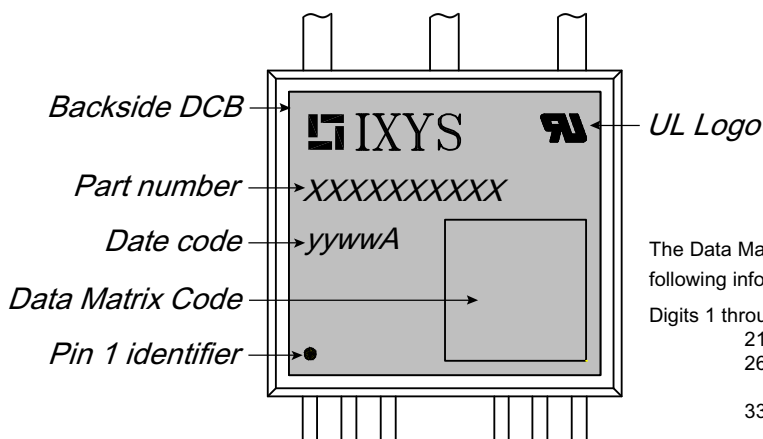

The Data Matrix Code contains the following information in 36 digits:

- Digits 1 through 20: part number
- 21 to 25: date code (YYWWA)
- 26 to 31: assembly lot code
- 32: reserved for special information
- 33 to 36: may be used for subsequent module numbering within the assembly lot

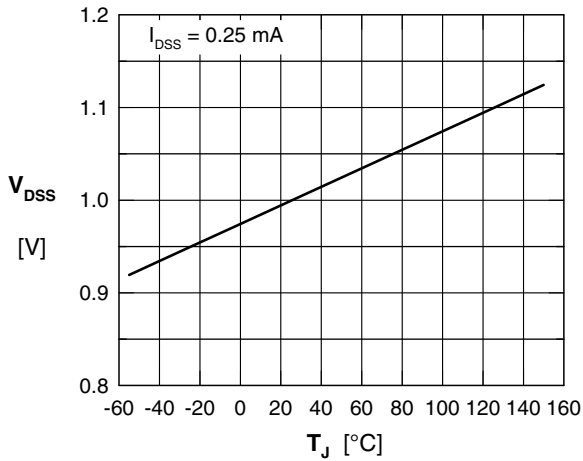

Fig.1 Drain source breakdown voltage versus temperature T_{VJ}

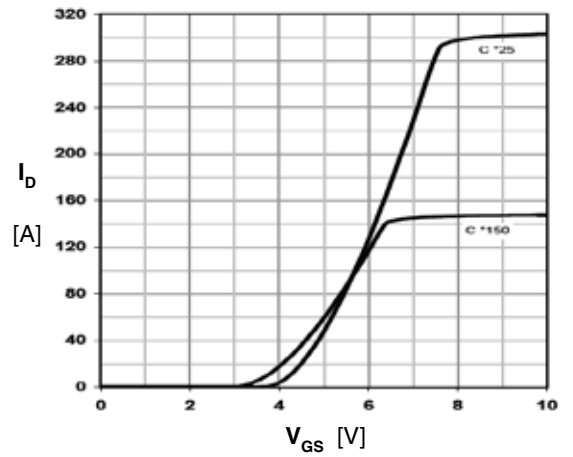

Fig. 2 Typ. transfer characteristics

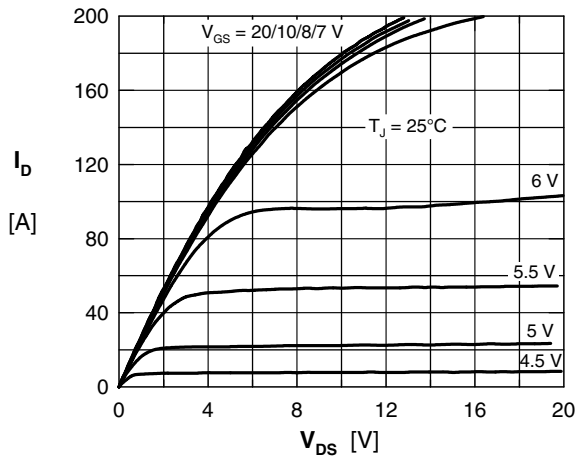

Fig. 3 Typical output characteristics

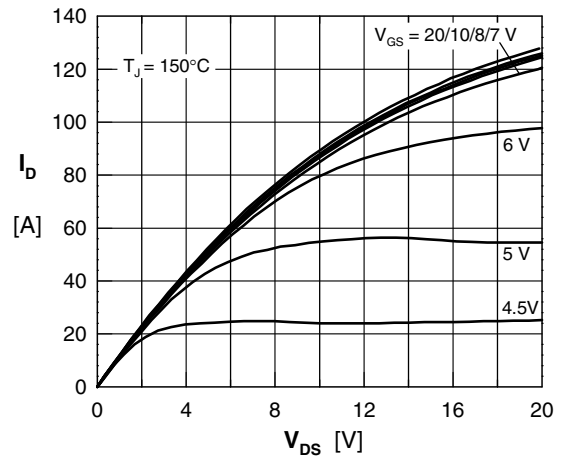

Fig. 4 Typical output characteristics

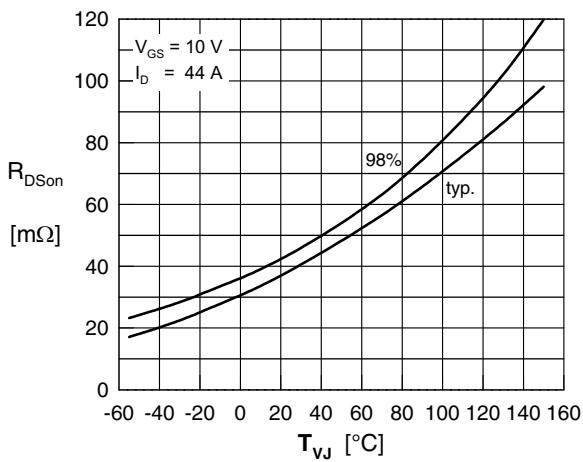

Fig.5 Drain source on-state resistance $R_{DS(on)}$ vs. junction temperature T_{VJ}

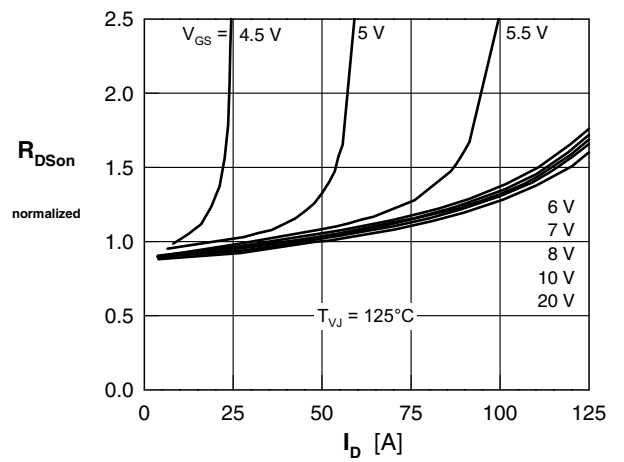

Fig. 6 Drain source on-state resistance, $R_{DS(on)}$ versus I_D

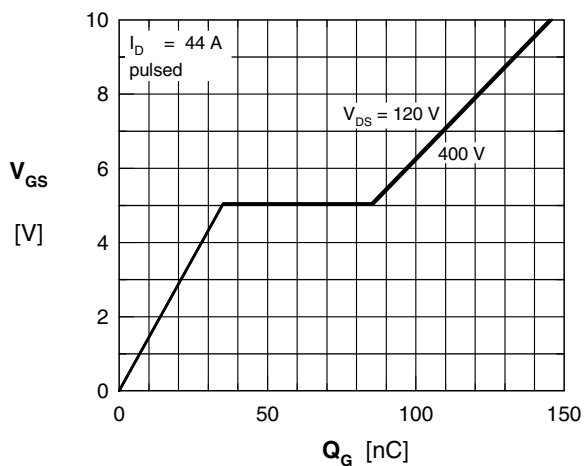

Fig. 7 Typ. turn-on gate charge

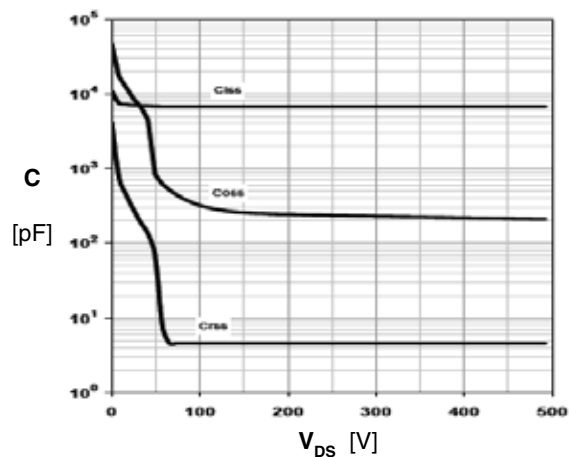

Fig. 8 Typ. capacities, MOSFET only

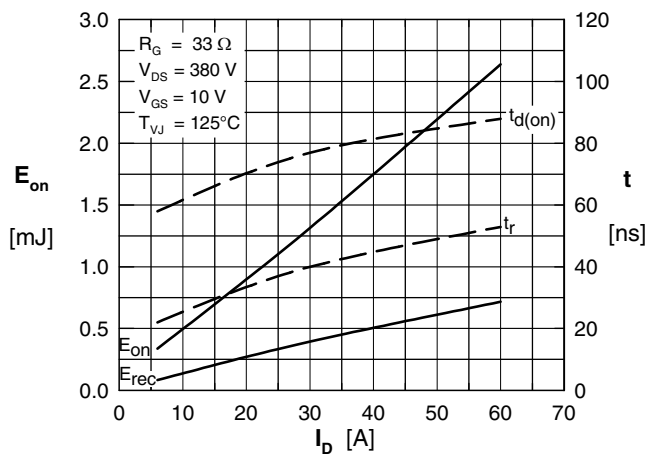

Fig. 9 Typ. turn-on energy and switching times vs. collector current, inductive switching

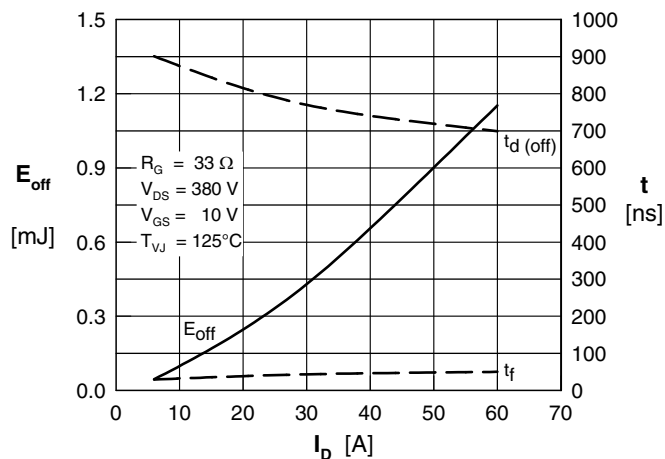

Fig. 10 Typ. turn-off energy and switching times vs. collector-current, inductive switching

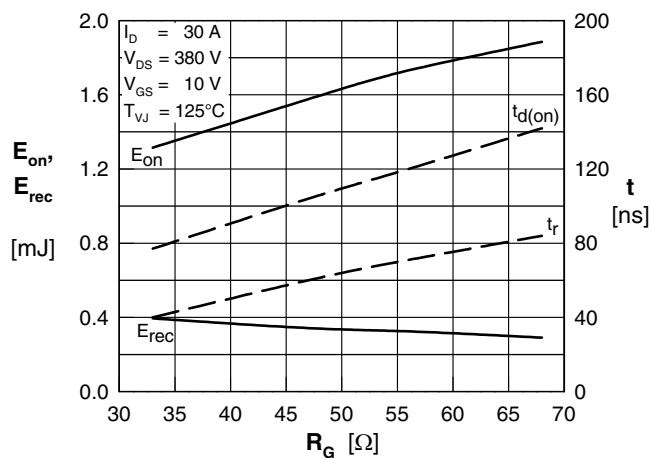

Fig. 11 Typ. turn-on energy and switching times vs. gate resistor, inductive switching

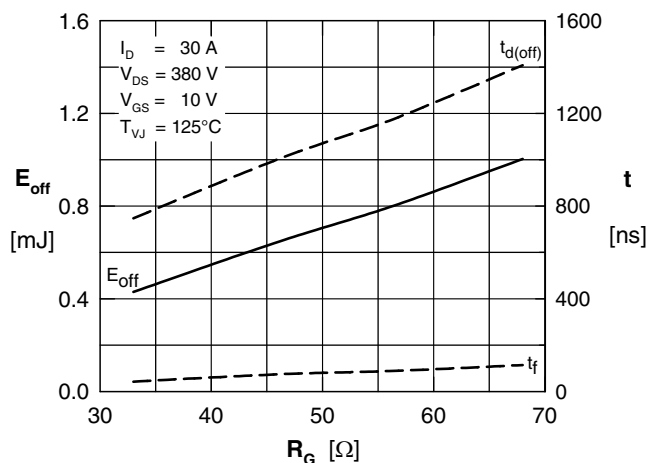

Fig. 12 Typ. turn-off energy and switching times vs. gate resistor, inductive switching

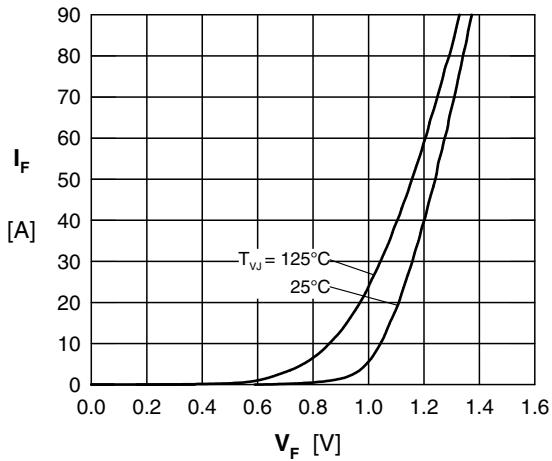

Fig. 13 Typ. forward characteristics of diode D

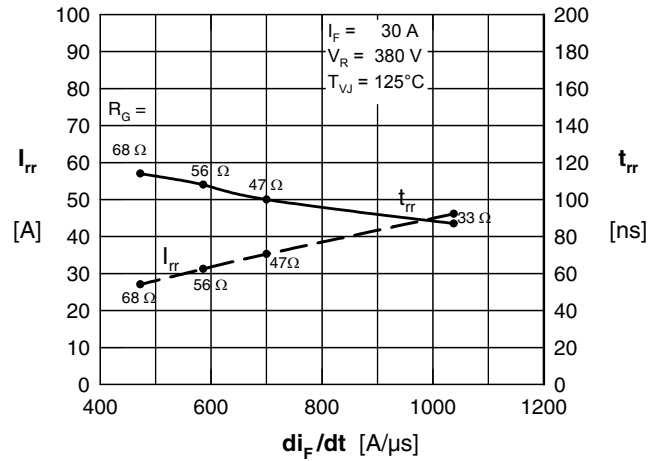

Fig. 14 Typ. reverse recovery characteristics of diode D

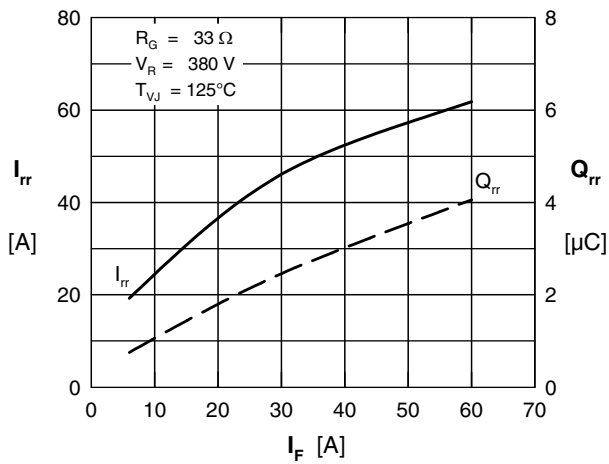

Fig. 15 Typ. reverse recovery characteristics of diode D



Disclaimer Notice - Information furnished is believed to be accurate and reliable. However, users should independently evaluate the suitability of and test each product selected for their own applications. Littelfuse products are not designed for, and may not be used in, all applications. Read complete Disclaimer Notice at www.littelfuse.com/disclaimer-electronics.



Компания «ЭлектроПласт» предлагает заключение долгосрочных отношений при поставках импортных электронных компонентов на взаимовыгодных условиях!

Наши преимущества:

- Оперативные поставки широкого спектра электронных компонентов отечественного и импортного производства напрямую от производителей и с крупнейших мировых складов;
- Поставка более 17-ти миллионов наименований электронных компонентов;
- Поставка сложных, дефицитных, либо снятых с производства позиций;
- Оперативные сроки поставки под заказ (от 5 рабочих дней);
- Экспресс доставка в любую точку России;
- Техническая поддержка проекта, помощь в подборе аналогов, поставка прототипов;
- Система менеджмента качества сертифицирована по Международному стандарту ISO 9001;
- Лицензия ФСБ на осуществление работ с использованием сведений, составляющих государственную тайну;
- Поставка специализированных компонентов (Xilinx, Altera, Analog Devices, Intersil, Interpoint, Microsemi, Aeroflex, Peregrine, Syfer, Eurofarad, Texas Instrument, Miteq, Cobham, E2V, MA-COM, Hittite, Mini-Circuits, General Dynamics и др.);

Помимо этого, одним из направлений компании «ЭлектроПласт» является направление «Источники питания». Мы предлагаем Вам помощь Конструкторского отдела:

- Подбор оптимального решения, техническое обоснование при выборе компонента;
- Подбор аналогов;
- Консультации по применению компонента;
- Поставка образцов и прототипов;
- Техническая поддержка проекта;
- Защита от снятия компонента с производства.



Как с нами связаться

Телефон: 8 (812) 309 58 32 (многоканальный)

Факс: 8 (812) 320-02-42

Электронная почта: org@eplast1.ru

Адрес: 198099, г. Санкт-Петербург, ул. Калинина, дом 2, корпус 4, литера А.