

LOC		DIST		REVISIONS			
AD	00	F	LTR	DESCRIPTION	DATE	DMN	APVD
		K2	REVISED	PER ECO-11-004820	11MAR11	RK	HMR

- 1 0.38µm[.000015] MIN GOLD ALL OVER 1.27µm[.000050] MIN NICKEL IN CONTACT AREA
- 2 0.76µm[.000030] MIN GOLD ALL OVER 1.27µm[.000050] MIN NICKEL IN CONTACT AREA
- 3 0.51µm[.000020] MIN GOLD ALL OVER 1.27µm[.000050] MIN NICKEL IN CONTACT AREA
- 4 NO INK STAMPING ON 1-153666-5 PART
- 5 ALL PARTS ASSEMBLED IN MEXICO MUST BE STAMPED "ASSY IN MEXICO" THE WORD "MEXICO" CAN BE SUBSTITUTED ONLY WHERE PART SIZE PROHIBITS STAMPING "ASSY IN MEXICO" INK STAMP COLOR WHITE OR HOT STAMP (NO WHITE TAPE) 115-9009 APPROX. WHERE SHOWN SIDE OPTIONAL
- 6 MATTE TIN PLATED CONTACT TAILS
- 7 HOUSING: GLASS FILLED POLYESTER, GREEN CONTACTS: PHOSPHOR BRONZE
- 8 MOLDED CHARACTERS (UPPER & LOWER CASE LETTERS FOLLOWED BY UPPER CASE LETTERS AA, AB, ETC.) OMITTING LETTERS G,I,O, & Q
- 9 AMP PART NUMBER AND DATE CODE INK STAMPED WHITE OR HOT STAMP NO WHITE TAPE IN THIS AREA (SIDE OPTIONAL)
- 10 BRIGHT TIN POST
- 11 OBSOLETE PARTS: OBSOLETE CIS STREAMLINING PER D.RENAUD/D.SINISI

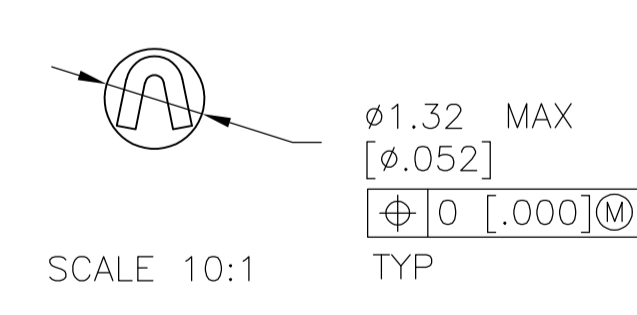
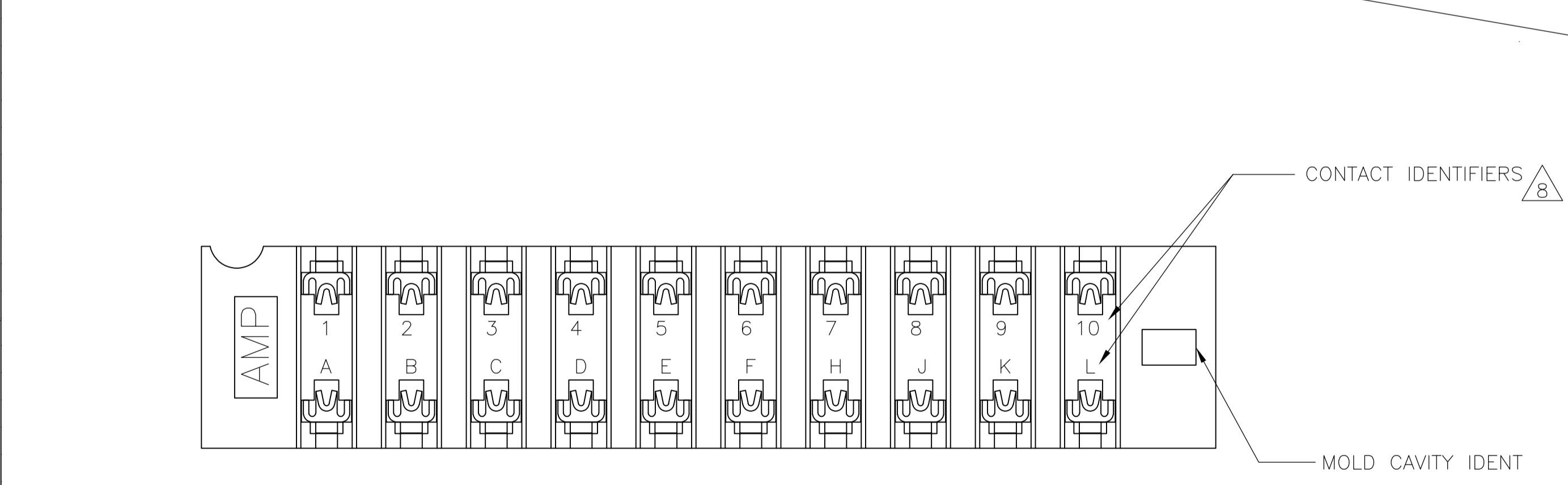
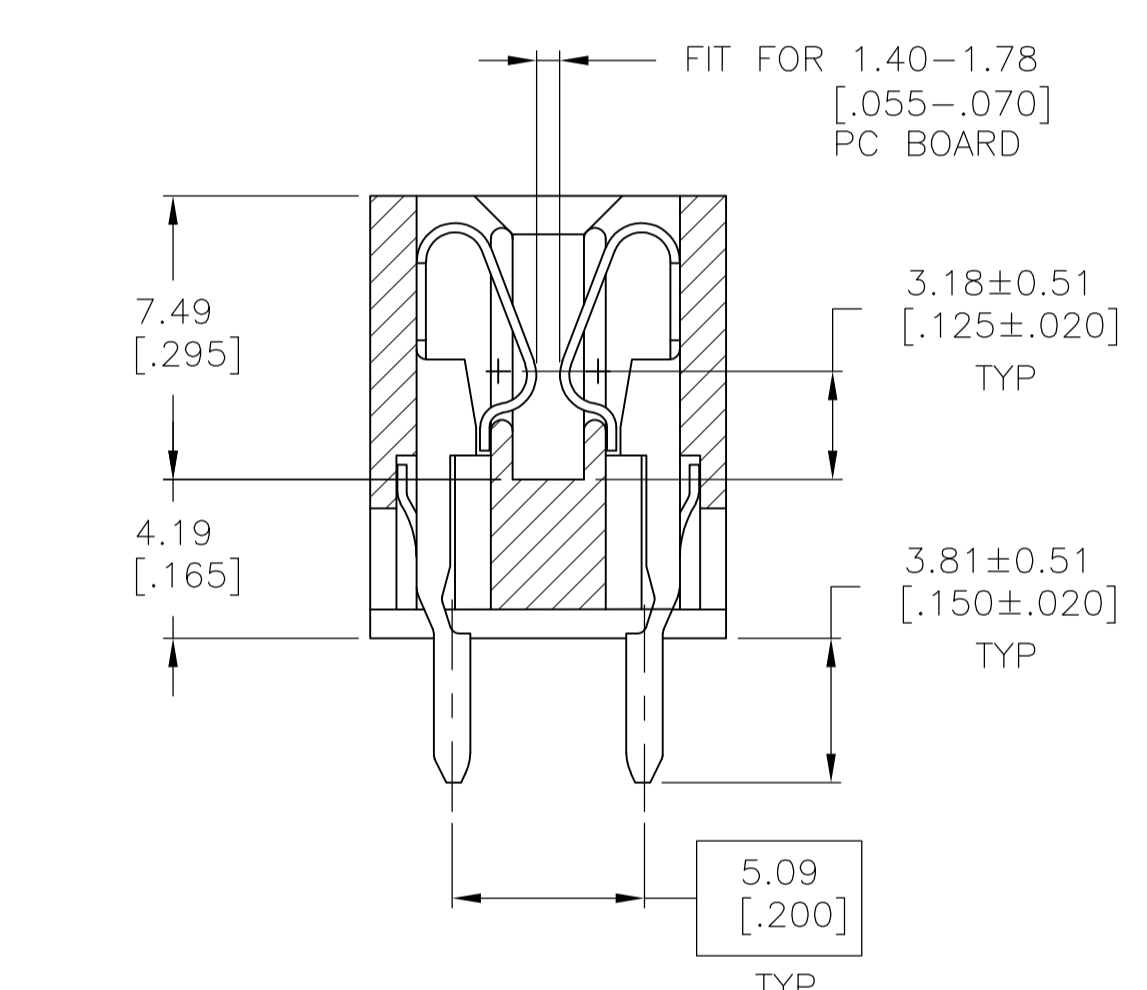
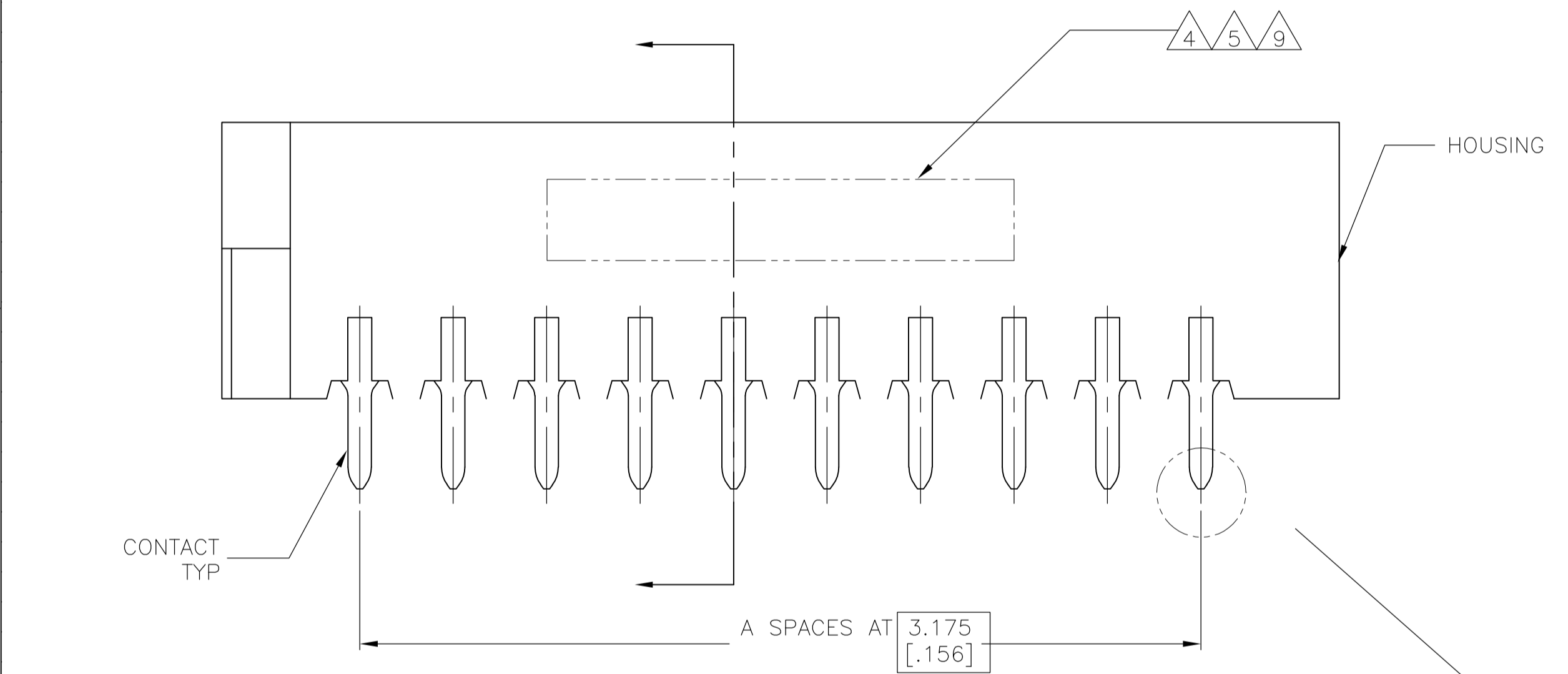
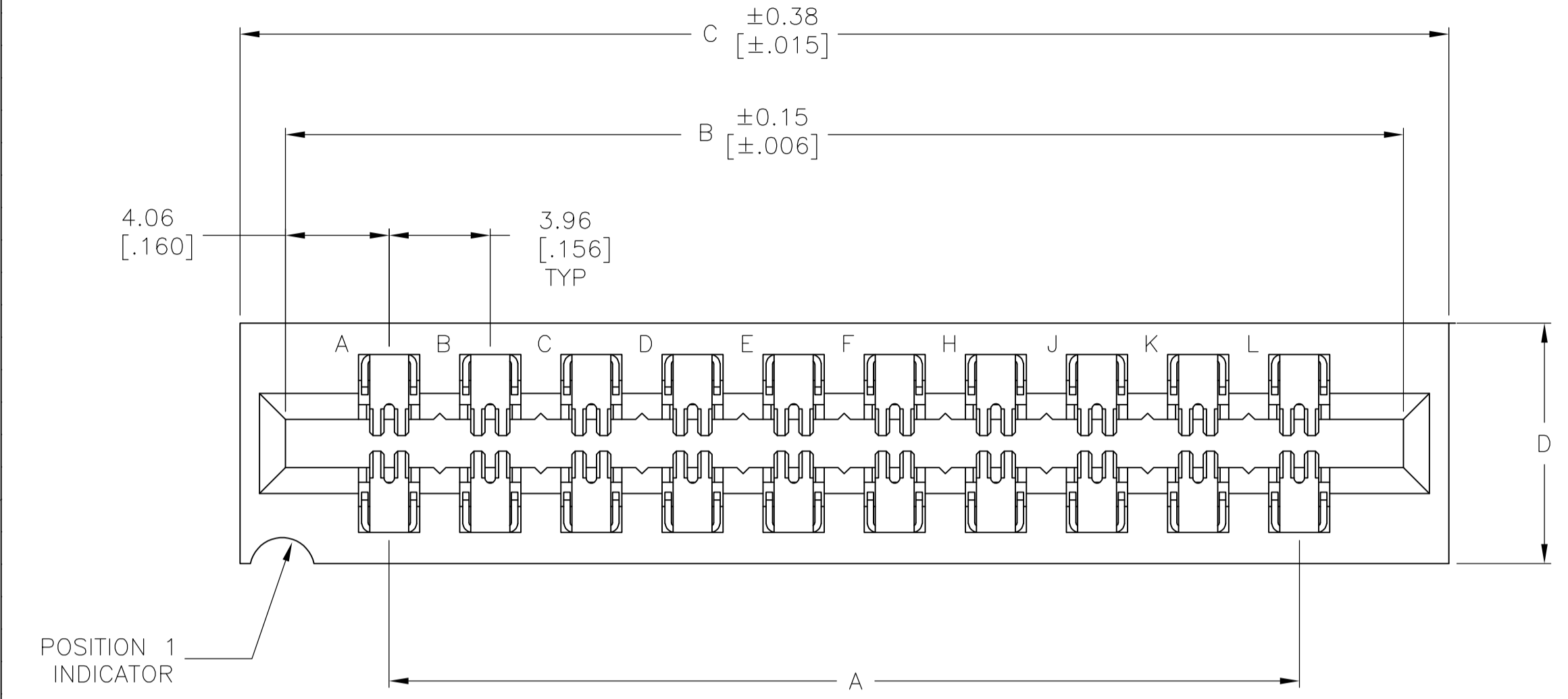

REV	DESCRIPTION	DATE	DMN	APVD	NO OF POSN	PART NUMBER
11	OBSOLETE	11.10 [4.37]	178.10 [7.012]	174.55 [6.872]	166.42 [6.552]	43 8-530666-3
		9.40 [3.70]	118.67 [4.672]	115.11 [4.532]	106.98 [4.212]	28 8-530666-2
11	OBSOLETE	11.10 [4.37]	126.59 [4.984]	123.04 [4.844]	114.91 [4.524]	30 7-530666-9
		9.40 [3.70]	94.89 [3.736]	91.34 [3.596]	83.21 [3.276]	22 7-530666-6
11	OBSOLETE	9.40 [3.70]	79.04 [3.112]	75.49 [2.972]	67.36 [2.652]	18 7-530666-5
		9.40 [3.70]	67.16 [2.644]	63.60 [2.504]	55.47 [2.184]	15 7-530666-4
		9.40 [3.70]	55.27 [2.176]	51.71 [2.036]	43.59 [1.716]	12 7-530666-3
		9.40 [3.70]	47.35 [1.864]	43.79 [1.724]	35.66 [1.404]	10 7-530666-2
		9.40 [3.70]	31.50 [1.240]	27.94 [1.100]	19.81 [0.780]	6 7-530666-1
11	OBSOLETE	11.10 [4.37]	178.10 [7.012]	174.55 [6.872]	166.42 [6.552]	43 3-530666-3
		9.40 [3.70]	118.67 [4.672]	115.11 [4.532]	106.98 [4.212]	28 3-530666-2
		11.10 [4.37]	182.07 [7.168]	178.51 [7.028]	170.38 [6.708]	44 3-530666-1
		11.10 [4.37]	150.37 [5.920]	146.81 [5.780]	138.68 [5.460]	36 3-530666-0
		11.10 [4.37]	126.59 [4.984]	123.04 [4.844]	114.91 [4.524]	30 2-530666-9
		9.40 [3.70]	106.78 [4.204]	103.23 [4.064]	95.10 [3.744]	25 2-530666-8
		9.40 [3.70]	102.82 [4.048]	99.26 [3.908]	91.14 [3.588]	24 2-530666-7
		9.40 [3.70]	94.89 [3.736]	91.34 [3.596]	83.21 [3.276]	22 2-530666-6
11	OBSOLETE	9.40 [3.70]	79.04 [3.112]	75.49 [2.972]	67.36 [2.652]	18 2-530666-5
		9.40 [3.70]	67.16 [2.644]	63.60 [2.504]	55.47 [2.184]	15 2-530666-4
		9.40 [3.70]	55.27 [2.176]	51.71 [2.036]	43.59 [1.716]	12 2-530666-3
		9.40 [3.70]	47.35 [1.864]	43.79 [1.724]	35.66 [1.404]	10 2-530666-2
		9.40 [3.70]	31.50 [1.240]	27.94 [1.100]	19.81 [0.780]	6 2-530666-1
		9.40 [3.70]	118.67 [4.672]	115.11 [4.532]	106.98 [4.212]	28 1-530666-5
		11.10 [4.37]	178.10 [7.012]	174.55 [6.872]	166.42 [6.552]	43 1-530666-3
		9.40 [3.70]	118.67 [4.672]	115.11 [4.532]	106.98 [4.212]	28 1-530666-2
		11.10 [4.37]	182.07 [7.168]	178.51 [7.028]	170.38 [6.708]	44 1-530666-1
		11.10 [4.37]	150.37 [5.920]	146.81 [5.780]	138.68 [5.460]	36 1-530666-0
		11.10 [4.37]	126.59 [4.984]	123.04 [4.844]	114.91 [4.524]	30 530666-9
		9.40 [3.70]	106.78 [4.204]	103.23 [4.064]	95.10 [3.744]	25 530666-8
		9.40 [3.70]	102.82 [4.048]	99.26 [3.908]	91.14 [3.588]	24 530666-7
		9.40 [3.70]	94.89 [3.736]	91.34 [3.596]	83.21 [3.276]	22 530666-6
		9.40 [3.70]	79.04 [3.112]	75.49 [2.972]	67.36 [2.652]	18 530666-5
		9.40 [3.70]	67.16 [2.644]	63.60 [2.504]	55.47 [2.184]	15 530666-4
		9.40 [3.70]	55.27 [2.176]	51.71 [2.036]	43.59 [1.716]	12 530666-3
		9.40 [3.70]	47.35 [1.864]	43.79 [1.724]	35.66 [1.404]	10 530666-2
		9.40 [3.70]	31.50 [1.240]	27.94 [1.100]	19.81 [0.780]	6 530666-1

THIS DRAWING IS A CONTROLLED DOCUMENT.

APPROVED: D. WILKE 18SEP97

DESIGNED: D. HARDY 12SEP97

TE Connectivity

HOUSING ASSEMBLY, LOW PROFILE EDGE CONNECTOR, FLOW SOLDER FOR .052 DIA HOLE, .156 X .200 CENTERS

108-9044

SIZE: A1 WEIGHT: 00779 C=530666

CUSTOMER DRAWING SCALE: 5:1 SHEET: 1 OF 1 REV: K2



Компания «ЭлектроПласт» предлагает заключение долгосрочных отношений при поставках импортных электронных компонентов на взаимовыгодных условиях!

Наши преимущества:

- Оперативные поставки широкого спектра электронных компонентов отечественного и импортного производства напрямую от производителей и с крупнейших мировых складов;
- Поставка более 17-ти миллионов наименований электронных компонентов;
- Поставка сложных, дефицитных, либо снятых с производства позиций;
- Оперативные сроки поставки под заказ (от 5 рабочих дней);
- Экспресс доставка в любую точку России;
- Техническая поддержка проекта, помощь в подборе аналогов, поставка прототипов;
- Система менеджмента качества сертифицирована по Международному стандарту ISO 9001;
- Лицензия ФСБ на осуществление работ с использованием сведений, составляющих государственную тайну;
- Поставка специализированных компонентов (Xilinx, Altera, Analog Devices, Intersil, Interpoint, Microsemi, Aeroflex, Peregrine, Syfer, Eurofarad, Texas Instrument, Miteq, Cobham, E2V, MA-COM, Hittite, Mini-Circuits, General Dynamics и др.);

Помимо этого, одним из направлений компании «ЭлектроПласт» является направление «Источники питания». Мы предлагаем Вам помощь Конструкторского отдела:

- Подбор оптимального решения, техническое обоснование при выборе компонента;
- Подбор аналогов;
- Консультации по применению компонента;
- Поставка образцов и прототипов;
- Техническая поддержка проекта;
- Защита от снятия компонента с производства.



Как с нами связаться

Телефон: 8 (812) 309 58 32 (многоканальный)

Факс: 8 (812) 320-02-42

Электронная почта: org@eplast1.ru

Адрес: 198099, г. Санкт-Петербург, ул. Калинина, дом 2, корпус 4, литера А.