



ORCA™ OR3LxxxB Series Device Datasheet

June 2010

All Devices Discontinued!

Product Change Notifications (PCNs) have been issued to discontinue all devices in this data sheet.

The original datasheet pages have not been modified and do not reflect those changes. Please refer to the table below for reference PCN and current product status.

| Product Line | Ordering Part Number | Product Status | Reference PCN |
|-----------------|----------------------|---------------------|---------------------------|
| OR3L165B | OR3L165B8PS208-DB | Discontinued | PCN#06-07 |
| | OR3L165B7PS208-DB | | |
| | OR3L165B7PS208I-DB | | |
| | OR3L165B8PS240-DB | | |
| | OR3L165B7PS240-DB | | |
| | OR3L165B7PS240I-DB | | |
| | OR3L165B8BA352-DB | | PCN#09-10 |
| | OR3L165B7BA352-DB | | |
| | OR3L165B7BA352I-DB | | |
| | OR3L165B8BC432-DB | | |
| | OR3L165B7BC432-DB | | |
| | OR3L165B7BC432I-DB | | |
| | OR3L165B8BM680-DB | | |
| | OR3L165B7BM680-DB | | |
| | OR3L165B7BM680I-DB | | |
| OR3L225B | OR3L225B8BC432-DB | Discontinued | PCN#06-07 |
| | OR3L225B7BC432-DB | | |
| | OR3L225B7BC432I-DB | | |
| | OR3L225B8BM680-DB | | |
| | OR3L225B7BM680-DB | | |
| | OR3L225B7BM680I-DB | | |

ORCA® OR3LxxxB Series Field-Programmable Gate Arrays

Introduction

This data addendum refers to the information found in the *ORCA® Series 3C and 3T Field-Programmable Gate Arrays* Data Sheet.

Features

- High-performance, cost-effective, 0.25 μm 5-level metal technology.
- 2.5 V internal supply voltage and 3.3 V I/O supply voltage for speed and compatibility.
- Up to 340,000 usable gates[‡] in 0.25 μm .
- Up to 612 user I/Os in 0.25 μm . (OR3LxxxB I/Os are 5 V tolerant to allow interconnection to both 3.3 V and 5 V devices, selectable on a per-pin basis, when using 3.3 V I/O supply.)
- Twin-quad programmable function unit (PFU) architecture with eight 16-bit look-up tables (LUTs) per PFU, organized in two nibbles for use in nibble- or byte-wide functions. Allows for mixed arithmetic and logic functions in a single PFU.
- Nine user registers per PFU, one following each LUT, plus one extra. All have programmable clock enable and local set/reset, plus a global set/reset that can be disabled per PFU.
- Flexible input structure (FINS) of the PFUs provides a routability enhancement for LUTs with shared inputs and the logic flexibility of LUTs with independent inputs.
- Fast carry logic and routing to adjacent PFUs for nibble-wide, byte-wide, or longer arithmetic functions, with the option to register the PFU carry-out.
- Softwired LUTs (SWL) allow fast cascading of up to three levels of LUT logic in a single PFU.
- Supplemental logic and interconnect cell (SLIC) provides 3-statable buffers, up to 10-bit decoder, and PAL*-like AND-OR-INVERT (AOI) in each programmable logic cell (PLC).
- Abundant hierarchical routing resources based on routing two data nibbles and two control lines per set provide for faster place and route implementations and less routing delay.
- Individually programmable drive capability: 12 mA sink/6 mA source or 6 mA sink/3 mA source.
- Built-in boundary scan (*/IEEE*[†] 1149.1 JTAG) and testability function to 3-state all I/O pins.
- Enhanced system clock routing for low-skew, high-speed clocks originating on-chip or at any I/O.
- Up to four ExpressCLK inputs allow extremely fast clocking of signals on- and off-chip plus access to internal general clock routing.
- StopCLK feature to glitchlessly stop/start the ExpressCLKs independently by user command.

* PAL is a trademark of Lattice Semiconductor

† */IEEE* is a registered trademark of The Institute of Electrical and Electronics Engineers, Inc.

Table 1. *ORCA* OR3LxxxB Series FPGAs

| Device | System Gates [‡] | LUTs | Registers | Max User RAM | User I/Os | Array Size | Process Technology |
|----------|---------------------------|-------|-----------|--------------|-----------|------------|--------------------------|
| OR3L165B | 120K—244K | 8192 | 10752 | 131K | 516 | 32 × 32 | 0.25 μm /5 LM |
| OR3L225B | 166K—340K | 11552 | 14820 | 185K | 612 | 38 × 38 | 0.25 μm /5 LM |

[‡] The usable gate counts range from a logic-only gate count to a gate count assuming 30% of the PFUs/SLICs being used as RAMs. The logic-only gate count includes each PFU/SLIC (counted as 108 gates/PFU), including 12 gates per LUT/FF pair (eight per PFU), and 12 gates per SLIC/FF pair (one per PFU). Each of the four PIOs per PIC is counted as 16 gates (three FFs, fast-capture latch, output logic, CLK, and I/O buffers). PFUs used as RAM are counted at four gates per bit, with each PFU capable of implementing a 32 × 4 RAM (or 512 gates) per PFU.

Table of Contents

| Contents | Page | Contents | Page |
|---|------|---|------|
| Introduction..... | 1 | Estimating Power Dissipation..... | 37 |
| Features | 1 | OR3LxxxB..... | 37 |
| System-Level Features..... | 4 | Pin Information | 38 |
| Support..... | 5 | Absolute Maximum Ratings..... | 76 |
| Description | 5 | Recommended Operating Conditions | 76 |
| FPGA Overview | 5 | Electrical Characteristics..... | 77 |
| PLC Logic | 5 | Package Thermal Characteristics | 78 |
| PIC Logic | 8 | Θ JA | 78 |
| System Features..... | 9 | ψ JC | 78 |
| Routing..... | 9 | Θ JC | 78 |
| Configuration..... | 9 | Θ JB | 78 |
| Configuration Data Format..... | 9 | FPGA Maximum Junction Temperature | 79 |
| Series 3L I/Os and 5 V Tolerance..... | 10 | Package Coplanarity | 80 |
| Designing with <i>ORCA</i> Series 3T Parts with | | Package Parasitics..... | 80 |
| Series 3L in Mind..... | 10 | Package Outline Diagrams..... | 81 |
| Powerup Sequencing for Series 3L Devices..... | 10 | Terms and Definitions..... | 81 |
| <i>ORCA</i> Foundry Development System | 11 | 208-Pin SQFP2..... | 82 |
| Additional Information | 11 | 240-Pin SQFP2..... | 83 |
| Timing Characteristics..... | 12 | 352-Pin PBGA..... | 84 |
| Configuration Timing..... | 12 | 432-Pin EBGA..... | 85 |
| PFU Timing | 13 | 680-Pin PBGAM..... | 86 |
| PLC Timing | 19 | Ordering Information | 87 |
| SLIC Timing | 19 | | |
| PIO Timing..... | 20 | | |
| Special Function Blocks Timing..... | 23 | | |
| Clock Timing | 25 | | |
| Description..... | 35 | | |

Table of Contents (continued)

| Figure | Page | Table | Page |
|---|-------------|---|------|
| Figure 1. Simplified PFU Diagram | 6 | Table 14. ExpressCLK (ECLK) and Fast Clock (FCLK) Timing Characteristics | 25 |
| Figure 2. SLIC All Modes Diagram | 7 | Table 15. General-Purpose Clock Timing Characteristics (Internally Generated Clock)..... | 26 |
| Figure 3. OR3Lxxx Programmable Input/Output Image from <i>ORCA</i> Foundry..... | 8 | Table 16. OR3Lxxx ExpressCLK to Output Delay (Pin-to-Pin) | 27 |
| Figure 4. Synchronous Memory Write Characteristics | 17 | Table 17. OR3Lxxx Fast Clock (FCLK) to Output Delay (Pin-to-Pin) | 28 |
| Figure 5. Synchronous Memory Read Cycle..... | 18 | Table 18. OR3Lxxx General System Clock (SCLK) to Output Delay (Pin-to-Pin)..... | 29 |
| Figure 6. ExpressCLK to Output Delay | 27 | Table 19. OR3Lxxx Input to ExpressCLK (ECLK) Fast-Capture Setup/Hold Time (Pin-to-Pin)..... | 30 |
| Figure 7. Fast Clock to Output Delay..... | 28 | Table 20. OR3Lxxx Input to Fast Clock Setup/Hold Time (Pin-to-Pin)..... | 32 |
| Figure 8. System Clock to Output Delay | 29 | Table 21. OR3Lxxx Input to General System Clock (SCLK) Setup/Hold Time (Pin-to-Pin)..... | 34 |
| Figure 9. Input to ExpressCLK Setup/Hold Time..... | 31 | Table 22. Derating for Commercial/Industrial OR3Lxxx Devices (I/O Supply VDD) | 36 |
| Figure 10. Input to Fast Clock Setup/Hold Time..... | 33 | Table 23. Derating for Commercial/Industrial OR3Lxxx Devices (I/O Supply VDD2) | 36 |
| Figure 11. Input to System Clock Setup/Hold Time... | 34 | Table 24. 208-Pin SQFP2 Pinout | 38 |
| Figure 12. Package Parasitics | 80 | Table 25. 240-Pin SQFP2 Pinout | 41 |
| | | Table 26. 352-Pin PBGA Pinout | 44 |
| | | Table 27. 432-Pin EBGA Pinout | 49 |
| | | Table 28. 680-Pin PBGAM Pinout..... | 60 |
| | | Table 29. Absolute Maximum Ratings..... | 76 |
| | | Table 30. Recommended Operating Conditions | 76 |
| | | Table 31. Electrical Characteristics | 77 |
| | | Table 32. Plastic Package Thermal Characteristics for the <i>ORCA</i> Series..... | 79 |
| | | Table 33. Package Coplanarity..... | 80 |
| | | Table 34. Package Parasitics | 80 |
| | | Table 35. Voltage Options | 87 |
| | | Table 36. Temperature Options | 87 |
| | | Table 37. Package Options | 87 |
| | | Table 38. <i>ORCA</i> OR3LxxxB Series Package Matrix..... | 87 |
| Table | Page | | |
| Table 1. <i>ORCA</i> OR3LxxxB Series FPGAs | 1 | | |
| Table 2. <i>ORCA</i> Series 3L System Performance..... | 4 | | |
| Table 3. Configuration Frame Size | 9 | | |
| Table 4. General Configuration Mode Timing Characteristics | 12 | | |
| Table 5. Combinatorial PFU Timing Characteristics .. | 13 | | |
| Table 6. Sequential PFU Timing Characteristics | 14 | | |
| Table 7. Ripple Mode PFU Timing Characteristics | 15 | | |
| Table 8. Synchronous Memory Write Characteristics..... | 17 | | |
| Table 9. Synchronous Memory Read Characteristics..... | 18 | | |
| Table 10. PFU Output MUX and Direct Routing Timing Characteristics..... | 19 | | |
| Table 11. Supplemental Logic and Interconnect Cell Timing Characteristics..... | 19 | | |
| Table 12. Programmable I/O Timing Characteristics | 20 | | |
| Table 13. Microprocessor Interface (MPI) Timing Characteristics..... | 23 | | |

Features (continued)

- Programmable I/O (PIO) has:
 - Fast-capture input latch and input flip-flop (FF)/latch for reduced input setup time and zero hold time.
 - Capability to (de)multiplex I/O signals.
 - Fast access to SLIC for decodes and *PAL*-like functions.
 - Output FF and two-signal function generator to reduce CLK to output propagation delay.
 - Fast open-drain drive capability.
- New programmable I/O 3-state FF allows 3-state buffer control signals to be set up a clock cycle early for improved clock to output delays.

System-Level Features

System-level features reduce glue logic requirements and make a system on a chip possible. These features in the *ORCA* OR3LxxxB include the following:

- Full PCI local bus compliance for all devices in 3.3 V and 5 V PCI systems. Pin-selectable I/O clamping diodes provide 3.3 V and 5 V compliance and 5 V tolerance.

- Dual-use microprocessor interface (MPI) can be used for configuration, readback, device control, and device status, as well as for a general-purpose interface to the FPGA. Glueless interface to *i960** and *PowerPC*† processors with user-configurable address space provided.
- Parallel readback of configuration data capability with the built-in microprocessor interface.
- Programmable clock manager (PCM) adjusts clock phase and duty cycle for input clock rates from 5 MHz to 120 MHz. The PCM may be combined with FPGA logic to create complex functions, such as digital phase-locked loops (DPLL), frequency counters, and frequency synthesizers. Two PCMs are provided per device.
- True internal 3-state, bidirectional buses with simple control provided by the SLIC.
- 32 × 4 RAM per PFU, configurable as single- or dual-port. Create large, fast RAM/ROM blocks (128 × 8 in only eight PFUs) using the SLIC decoders as bank drivers.
- Full UTOPIA Level III I/O compliance (6.0 ns CLK → OUT, 2.0 ns setup with 0 ns hold).

* *i960* is a registered trademark of Intel Corporation.

† *PowerPC* is a registered trademark of International Business Machines, Inc.

Table 2. *ORCA* Series 3L System Performance

| Parameter | # PFUs | -7 | -8 | Unit |
|---|--------|------|------|------|
| 16-bit Loadable Up/Down Counter | 2 | 151 | 176 | MHz |
| 16-bit Accumulator | 2 | 151 | 176 | MHz |
| 8 × 8 Parallel Multiplier: | | | | |
| Multiplier Mode, Unpipelined ¹ | 11.5 | 38 | 46 | MHz |
| ROM Mode, Unpipelined ² | 8 | 93 | 116 | MHz |
| Multiplier Mode, Pipelined ³ | 15 | 129 | 152 | MHz |
| 32 × 16 RAM (synchronous): | | | | |
| Single-port, 3-state Bus ⁴ | 4 | 173 | 209 | MHz |
| Dual-port ⁵ | 4 | 231 | 277 | MHz |
| 128 × 8 RAM (synchronous): | | | | |
| Single-port, 3-state Bus ⁴ | 8 | 151 | 181 | MHz |
| Dual-port ⁵ | 8 | 151 | 181 | MHz |
| 8-bit Address Decode (internal): | | | | |
| Using Softwired LUTs | 0.25 | 2.30 | 2.00 | ns |
| Using SLICs ⁶ | 0 | 1.29 | 1.12 | ns |
| 32-bit Address Decode (internal): | | | | |
| Using Softwired LUTs | 2 | 7.97 | 6.84 | ns |
| Using SLICs ⁷ | 0 | 3.75 | 3.16 | ns |
| 36-bit Parity Check (internal) | 2 | 7.97 | 6.84 | ns |

1. Implemented using 8 × 1 multiplier mode (unpipelined), register-to-register, two 8-bit inputs, one 16-bit output.

2. Implemented using two 32 × 12 ROMs and one 12-bit adder, one 8-bit input, one fixed operand, one 16-bit output.

3. Implemented using 8 × 1 multiplier mode (fully pipelined), two 8-bit inputs, one 16-bit output (seven of 15 PFUs contain only pipelining registers).

4. Implemented using 32 × 4 RAM mode with read data on 3-state buffer to bidirectional read/write bus.

5. Implemented using 32 × 4 dual-port RAM mode.

6. Implemented in one partially occupied SLIC with decoded output set up to CE in same PLC.

7. Implemented in five partially occupied SLICs.

Support

- *ORCA* Foundry development system support.
- Supported by industry-standard CAE tools for design entry, synthesis, simulation, and timing analysis.

Description

FPGA Overview

The *ORCA* OR3LxxxB FPGAs are a new generation of SRAM-based FPGAs built on the successful Series 2 and Series 3 FPGA lines, with enhancements and innovations geared toward today's high-speed designs and tomorrow's systems on a single chip. Designed from the start to be synthesis friendly and to reduce place and route times while maintaining the complete routability of the *ORCA* Series 2 devices, the OR3LxxxB Series more than doubles the logic available in each logic block and incorporates system-level features that can further reduce logic requirements and increase system speed. *ORCA* OR3LxxxB devices contain many new patented enhancements and are offered in a variety of packages, speed grades, and temperature ranges.

The *ORCA* OR3LxxxB Series FPGAs consist of three basic elements: PLCs, programmable input/output cells (PICs), and system-level features. An array of PLCs is surrounded by PICs. Each PLC contains a PFU, a SLIC, local routing resources, and configuration RAM. Most of the FPGA logic is performed in the PFU (see Figure 1), but decoders, *PAL*-like functions, and 3-state buffering can be performed in the SLIC (see Figure 2). The PICs provide device inputs and outputs and can be used to register signals and to perform input demultiplexing, output multiplexing, and other functions on two output signals (see Figure 3). Some of the system-level functions include the MPI and the PCM.

PLC Logic

Each PFU within a PLC contains eight 4-input (16-bit) LUTs, eight latches/FFs, and one additional FF that may be used independently or with arithmetic functions.

The PFU is organized in a twin-quad fashion: two sets of four LUTs and FFs that can be controlled independently. LUTs may also be combined for use in arithmetic functions using fast-carry chain logic in either 4-bit or 8-bit modes. The carry-out of either mode may be registered in the ninth FF for pipelining. Each PFU may also be configured as a synchronous 32×4 single- or dual-port RAM or ROM. The FFs (or latches) may obtain input from LUT outputs or directly from invertible PFU inputs, or they can be tied high or tied low. The FFs also have programmable clock polarity, clock enables, and local set/reset.

The SLIC is connected to PLC routing resources and to the outputs of the PFU. It contains 3-state, bidirectional buffers and logic to perform up to a 10-bit AND function for decoding, or an AND-OR with optional INVERT to perform *PAL*-like functions. The 3-state drivers in the SLIC and their direct connections to the PFU outputs make fast, true 3-state buses possible within the FPGA, reducing required routing and allowing for real-world system performance.

Description (continued)

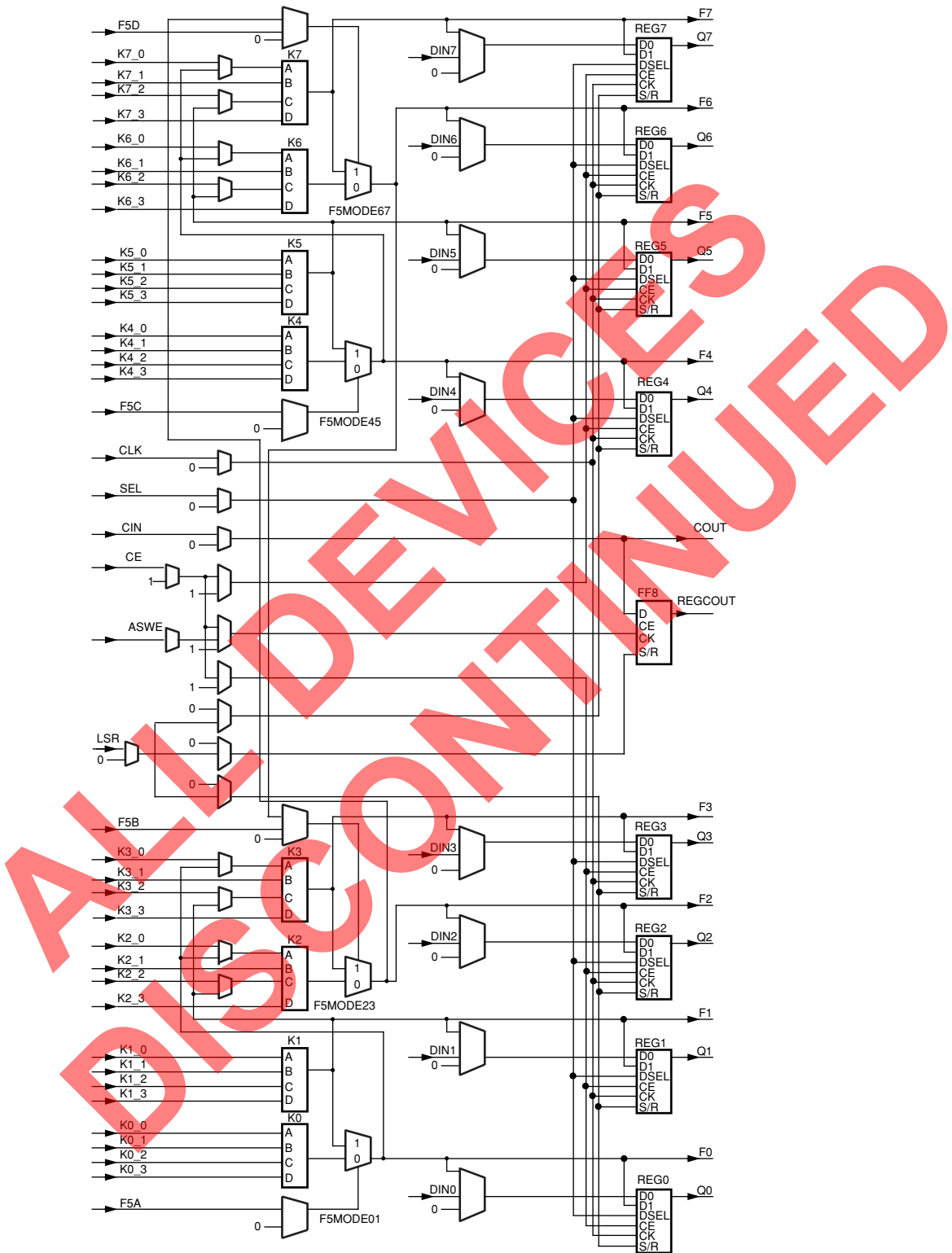

5-5743

Note: All multiplexers without select inputs are configuration selector multiplexers.

Figure 1. Simplified PFU Diagram

Description (continued)

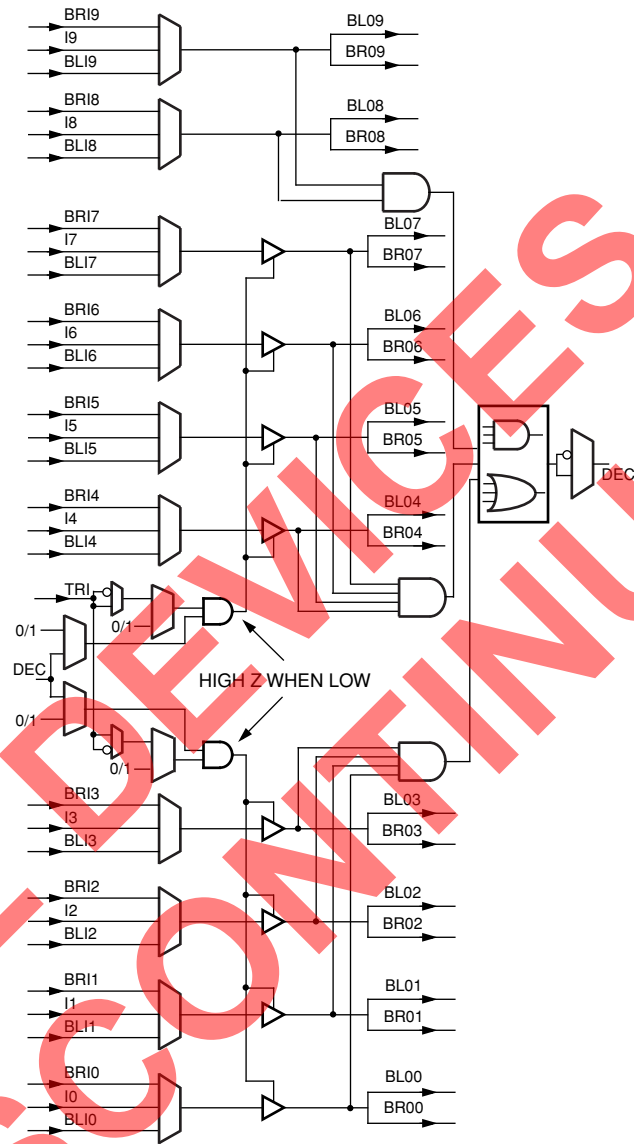

5-5744(F)

Figure 2. SLIC All Modes Diagram

Description (continued)

PIC Logic

The OR3LxxxB PIC addresses the demand for ever-increasing system clock speeds. Each PIC contains four programmable inputs/outputs (PIOs) and routing resources. On the input side, each PIO contains a fast-capture latch that is clocked by an ExpressCLK. This latch is followed by a latch/FF that is clocked by a system clock from the internal general clock routing. The combination provides for very low setup requirements and zero hold times for signals coming on-chip. It may also be used to demultiplex an input signal, such as a multiplexed address/data signal, and register the signals without explicitly building a demultiplexer. Two input signals are available to the PLC array from each PIO, and the *ORCA* Series 2 capability to use any input pin as a clock or other global input is maintained.

On the output side of each PIO, two outputs from the PLC array can be routed to each output flip-flop, and logic can be associated with each I/O pad. The output logic associated with each pad allows for multiplexing of output signals and other functions of two output signals.

The output FF, in combination with output signal multiplexing, is particularly useful for registering address signals to be multiplexed with data, allowing a full clock cycle for the data to propagate to the output. The I/O buffer associated with each pad is very similar to the Series 2 buffer with a new, fast, open-drain option for ease of use on system buses. These features may also be combined with the new 3-state FF that allows the 3-state control signal to be registered. This allows for early control setup and faster clock-to-out times.



5-5805(F).a

Figure 3. OR3Lxxx Programmable Input/Output Image from *ORCA* Foundry

Description (continued)

System Features

The OR3LxxxB Series also provides system-level functionality by means of its dual-use MPI and its innovative PCM. These functional blocks allow for easy glueless system interfacing and the capability to adjust to varying conditions in today's high-speed systems.

The MPI provides a glueless interface between the FPGA, *PowerPC*, and *i960* microprocessors. It can be used for configuration and readback, as well as for monitoring FPGA status. The MPI also provides a general-purpose microprocessor interface to the FPGA user-defined logic following configuration.

Two PCMs are provided on each *ORCA 3L* device. Each PCM can be used to manipulate the frequency, phase, and duty cycle of a clock signal. Clocks may be input from the dedicated corner ExpressCLK input (in the same corner as the PCM block) or from general routing. Output clocks from the PCM can be sent to the system clock spines, and/or to the ExpressCLK and fast clock spines on the edges of the device adjacent to the PCM. ExpressCLK/fast clock and system clock output frequencies can differ by up to a factor of eight to allow slow I/O clocking with fast internal processing (or vice versa). Each PCM is capable of manipulating clocks from 5 MHz to 120 MHz. Frequencies can be adjusted from 1/8x to 64x the input clock frequency, duty cycles, and phase delays can be adjusted from 3.125% to 96.875%.

Configuration Data Format

The length and number of data frames and information on the PROM size for the Series OR3LxxxB FPGAs are given in Table 3.

Table 3. Configuration Frame Size

| Devices | 3L165B | 3L225B |
|--|-----------|-----------|
| Number of Frames | 2136 | 2520 |
| Data Bits/Frame | 502 | 592 |
| Configuration Data (number of frames × number of data bits/frame) | 1,072,272 | 1,552,320 |
| Maximum Total Number Bits/Frame (align bits, 01 frame start, 8-bit checksum, eight stop bits) | 520 | 610 |
| Maximum Configuration Data (number bits/frame × number of frames) | 1,110,720 | 1,537,200 |
| Maximum PROM Size (bits) (add configuration header and postamble) | 1,110,760 | 1,537,240 |

Routing

The abundant routing resources of the *ORCA 3LxxxB* FPGAs are organized to route signals individually or as buses with related control signals. Clocks are routed on a low-skew, high-speed distribution network and may be sourced from PLC logic, externally from any I/O pad, or from the very fast ExpressCLK pins. ExpressCLKs may be glitchlessly and independently enabled and disabled with a programmable control signal using the new StopCLK feature. The improved PIC routing resources are now similar to the patented intra-PLC routing resources and provide great flexibility in moving signals to and from the PIOs. This flexibility translates into an improved capability to route designs at the required speeds when the I/O signals have been locked to specific pins.

Configuration

The FPGA's functionality is determined by internal configuration RAM. The FPGA's internal initialization/configuration circuitry loads the configuration data at powerup or under system control. The RAM is loaded by using one of several configuration modes. The configuration data resides externally in an EEPROM or any other storage media. Serial EEPROMs provide a simple, low pin count method for configuring FPGAs. A new, easy method for configuring the devices is through the microprocessor interface.

Description (continued)

Series 3L I/Os and 5 V Tolerance

Series 3L devices use the same I/O structure as *ORCA* Series 3T devices. *ORCA* Series 3L devices use a 3.3 V supply (VDD) to power the I/Os and a 2.5 V supply (VDD2) to power the internal logic. Because the I/O structure and voltage is common between 3T and 3L devices, the Series 3L devices maintain 5 V tolerance and the same I/O characteristics as Series 3T devices.

The OR3LxxxB uses a default mode that maintains a 5 V tolerant setting on all I/Os.

Designing with *ORCA* Series 3T Parts with Series 3L in Mind

Due to many package compatibilities across device sizes and families, it is possible to design using a Series 3T device today, and migrate to a Series 3L device later. The pinouts are the same on both families with the exception of additional I/O voltage pins for the Series 3L family.

To design a board that is both Series 3T compatible and Series 3L compatible, using the following procedures will allow easy and fast component swapping from Series 3T to Series 3L.

Design to the Series 3L pinouts, especially if planning to use the OR3L225B pinout. The OR3L225B has additional power pins that are not on smaller Series 3L parts. (Note that if the designer is using a Series 3L device smaller than the OR3L225B, but may eventually migrate to a OR3L225B, the OR3L225B pinout should also be used). Designing for Series 3L in this manner does sacrifice some user I/O pins available in the Series 3T (or smaller Series 3L devices if using the OR3L225B). These I/Os will have power applied to them when a Series 3T device is used on the board. However, this is acceptable and these I/Os will default to 3-state outputs which eliminates any contention risk.

Design with two power planes: one for the internal supply (2.5 V), and one for the I/O supply (3.3 V). For Series 3T operation, connect both the internal supply and I/O voltage planes to 3.3 V. For Series 3L operation, change the core plane connection from 3.3 V to 2.5 V.

Powerup Sequencing for Series 3L Devices

ORCA Series 3L devices use two power supplies: one to power the device I/Os (VDD) which is set to 3.3 V for 3.3 V operation and 5 V tolerance, and another supply for the internal logic (VDD2) which is set to 2.5 V. It is understood that many users will derive the 2.5 V core logic supply from a 3.3 V power supply, so the following recommendations are made as to the powerup sequence of the supplies and allowable delays between power supplies reaching stable voltages.

In general, both the 3.3 V and the 2.5 V supplies should ramp-up and become stable as close together in time as possible. There is no delay requirement if the VDD2 (2.5 V) supply becomes stable prior to the VDD (3.3 V) supply. There is a delay requirement imposed if the VDD supply becomes stable prior to the VDD2 supply.

The requirement is that the VDD2 (2.5 V) supply transitions from 0.8 V to 2.3 V within 15.7 ms when the VDD (3.3 V) supply is already stable at a minimum of 3.0 V. If the chosen power supplies cannot meet this delay requirement, it is always possible to delay configuration of the FPGA by asserting INIT or PRGM until the VDD2 supply has reached 2.3 V. This process eliminates any power supply sequencing issues.

Description (continued)

ORCA Foundry Development System

The *ORCA* Foundry development system is used to process a design from a netlist to a configured FPGA. This system is used to map a design onto the *ORCA* architecture and then place and route it using *ORCA* Foundry's timing-driven tools. The development system also includes interfaces to, and libraries for, other popular CAE tools for design entry, synthesis, simulation, and timing analysis.

The *ORCA* Foundry development system interfaces to front-end design entry tools and provides the tools to produce a configured FPGA. In the design flow, the user defines the functionality of the FPGA at two points in the design flow: at design entry and at the bit stream generation stage.

Following design entry, the development system's map, place, and route tools translate the netlist into a routed FPGA. A static timing analysis tool is provided to determine device speed, and a back-annotated netlist can be created to allow simulation.

Timing and simulation output files from *ORCA* Foundry are also compatible with many third-party analysis tools. Its bit stream generator is then used to generate the configuration data, which is loaded into the FPGA's internal configuration RAM.

When using the bit stream generator, the user selects options that affect the functionality of the FPGA. Combined with the front-end tools, *ORCA* Foundry produces configuration data that implements the various logic and routing options discussed in this product brief.

Additional Information

Contact your local Lattice representative for additional information regarding the *ORCA* OR3LxxxB FPGA devices, or visit our website at:
<http://www.latticesemi.com>.

ALL DEVICES
DISCONTINUED

Timing Characteristics

Configuration Timing

Table 4. General Configuration Mode Timing Characteristics

OR3LxxB Commercial: VDD = 3.0 V to 3.6 V, VDD2 = 2.38 V to 2.63 V, 0 °C < TA < 70 °C; Industrial: VDD = 3.0 V to 3.6 V, VDD2 = 2.38 V to 2.63 V, -40 °C < TA < +85 °C.

| Symbol | Parameter | Min | Max | Unit | |
|---|--|--|---------|--------------|--------------|
| All Configuration Modes | | | | | |
| TSMODE | M[3:0] Setup Time to $\overline{\text{INIT}}$ High | 0.00 | — | ns | |
| THMODE | M[3:0] Hold Time from $\overline{\text{INIT}}$ High | 600.00 | — | ns | |
| TRW | $\overline{\text{RESET}}$ Pulse Width Low to Start Reconfiguration | 50.00 | — | ns | |
| TPGW | PRGM Pulse Width Low to Start Reconfiguration | 50.00 | — | ns | |
| Master and Asynchronous Peripheral Modes | | | | | |
| TPO | Power-on Reset Delay | 15.70 | 52.40 | ms | |
| TCCLK | CCLK Period (M3 = 0) | 60.00 | 200.00 | ns | |
| | | (M3 = 1) | 480.00 | 1600.00 | ns |
| TCL | Configuration Latency (autoincrement mode): | OR3L165B (M3 = 0) | 66.65 | 222.15* | ms |
| | | (M3 = 1) | 533.16 | 1777.22* | ms |
| | | OR3L225B (M3 = 0) | 92.23 | 307.45* | ms |
| | | (M3 = 1) | 737.88 | 2459.8* | ms |
| Microprocessor (MPI) Mode | | | | | |
| TPO | Power-on Reset Delay | 15.70 | 52.40 | ms | |
| TCL | Configuration Latency (autoincrement mode): | OR3L165B | 147,405 | — | write cycles |
| | | OR3L225B | 202,251 | — | write cycles |
| | | Partial Reconfiguration (explicit mode): | | | |
| TPR | OR3L165B | 69 | — | write cycles | |
| | | OR3L225B | 81 | — | write cycles |
| Slave Serial Mode | | | | | |
| TPO | Power-on Reset Delay | 3.90 | 13.10 | ms | |
| TCCLK | CCLK Period | 15.00 | | ns | |
| TCL | Configuration Latency (autoincrement mode): | OR3L165B | 16.66 | — | ms |
| | | OR3L225B | 23.06 | — | ms |
| | | Partial Reconfiguration (explicit mode): | | | |
| TPR | OR3L165B | 1.0 | — | μs/frame | |
| | | OR3L225B | 1.2 | — | μs/frame |
| Slave Parallel Mode | | | | | |
| TPO | Power-on Reset Delay | 3.90 | 13.10 | ms | |
| TCCLK | CCLK Period: | 15.00 | | ns | |
| TCL | Configuration Latency (normal mode): | OR3L165B | 2.08 | — | |
| | | OR3L225B | 2.88 | — | |
| | | Partial Reconfiguration (explicit mode): | | | |
| TPR | OR3L165B | 1.0 | — | μs/frame | |
| | | OR3L225B | 1.2 | — | μs/frame |

* Not applicable to asynchronous peripheral mode.

Note: TPO is triggered when VDD reaches between 2.7 V and 3.0 V for the OR3LxxxB.

Timing Characteristics (continued)

In addition to supply voltage, process variation, and operating temperature, circuit and process improvements of the *ORCA* Series FPGAs over time will result in significant improvement of the actual performance over those listed for a speed grade. Even though lower speed grades may still be available, the distribution of yield to timing parameters may be several speed grades higher than that designated on a product brand. Design practices need to consider best-case timing parameters (e.g., delays = 0), as well as worst-case timing.

The routing delays are a function of fan-out and the capacitance associated with the configurable interface points (CIPs) and metal interconnect in the path. The number of logic elements that can be driven (fan-out) by PFUs is unlimited, although the delay to reach a valid logic level can exceed timing requirements. It is difficult to make accurate routing delay estimates prior to design compilation based on fan-out. This is because the CAE software may delete redundant logic inserted by the designer to reduce fan-out, and/or it may also automatically reduce fan-out by net splitting.

The waveform test points are given in the Input/Output Buffer Measurement Conditions section of this data sheet. The timing parameters given in the electrical characteristics tables in this data sheet follow industry practices, and the values they reflect are described below.

Propagation Delay—The time between the specified reference points. The delays provided are the worst case of the t_{phh} and t_{pll} delays for noninverting functions, t_{plh} and t_{pll} for inverting functions, and t_{phz} and t_{plz} for 3-state enable.

Setup Time—The interval immediately preceding the transition of a clock or latch enable signal, during which the data must be stable to ensure it is recognized as the intended value.

Hold Time—The interval immediately following the transition of a clock or latch enable signal, during which the data must be held stable to ensure it is recognized as the intended value.

3-State Enable—The time from when a 3-state control signal becomes active and the output pad reaches the high-impedance state.

PFU Timing

Table 5. Combinatorial PFU Timing Characteristics

OR3LxxB Commercial: $V_{DD} = 3.0\text{ V to }3.6\text{ V}$, $V_{DD2} = 2.38\text{ V to }2.63\text{ V}$, $0\text{ }^{\circ}\text{C} < T_A < 70\text{ }^{\circ}\text{C}$; Industrial: $V_{DD} = 3.0\text{ V to }3.6\text{ V}$, $V_{DD2} = 2.38\text{ V to }2.63\text{ V}$, $-40\text{ }^{\circ}\text{C} < T_A < +85\text{ }^{\circ}\text{C}$.

| Symbol | Parameter | -7 | | -8 | | Unit |
|------------|--|-----|------|-----|------|------|
| | | Min | Max | Min | Max | |
| | Combinatorial Delays ($T_J = +85\text{ }^{\circ}\text{C}$, $V_{DD} = \text{min}$, $V_{DD2} = \text{min}$): | | | | | |
| F4_DEL | Four-input Variables (Kz[3:0] to F[z])* | — | 1.03 | — | 0.90 | ns |
| F5_DEL | Five-input Variables (F5[A:D] to F[0, 2, 4, 6]) | — | 0.85 | — | 0.74 | ns |
| SWL2_DEL | Two-level LUT Delay (Kz[3:0] to F w/feedbk)* | — | 2.30 | — | 2.00 | ns |
| SWL2F5_DEL | Two-level LUT Delay (F5[A:D] to F w/feedbk) | — | 1.91 | — | 1.66 | ns |
| SWL3_DEL | Three-level LUT Delay (Kz[3:0] to F w/feedbk)* | — | 3.40 | — | 2.96 | ns |
| SWL3F5_DEL | Three-level LUT Delay (F5[A:D] to F w/feedbk) | — | 3.02 | — | 2.63 | ns |
| CO_DEL | CIN to COUT Delay (logic mode) | — | 1.66 | — | 1.44 | ns |

* Four-input variables' (Kz[3:0]) path delays are valid for LUTs in both F4 (four-input LUT) and F5 (five-input LUT) modes.

Timing Characteristics (continued)

Table 6. Sequential PFU Timing Characteristics

OR3LxxxB Commercial: VDD = 3.0 V to 3.6 V, VDD2 = 2.38 V to 2.63 V, 0 °C < TA < 70 °C; Industrial: VDD = 3.0 V to 3.6 V, VDD2 = 2.38 V to 2.63 V, -40 °C < TA < +85 °C.

| Symbol | Parameter | -7 | | -8 | | Unit |
|-------------------------------|---|------|------|------|------|------|
| | | Min | Max | Min | Max | |
| Input Requirements | | | | | | |
| CLKL_MPW | Clock Low Time | 1.00 | — | 0.87 | — | ns |
| CLKH_MPW | Clock High Time | 0.76 | — | 0.66 | — | ns |
| GSR_MPW | Global S/R Pulse Width (GSRN) | 1.00 | — | 0.87 | — | ns |
| LSR_MPW | Local S/R Pulse Width | 1.00 | — | 0.87 | — | ns |
| | Combinatorial Setup Times (TJ = +85 °C, VDD = min, VDD2 = min): | | | | | |
| F4_SET | Four-input Variables to Clock (Kz[3:0] to CLK)* | 0.90 | — | 0.78 | — | ns |
| F5_SET | Five-input Variables to Clock (F5[A:D] to CLK) | 0.51 | — | 0.44 | — | ns |
| DIN_SET | Data In to Clock (DIN[7:0] to CLK) | 0.21 | — | 0.18 | — | ns |
| CINDIR_SET | Carry-in to Clock, DIRECT to REGCOUT (CIN to CLK) | 0.68 | — | 0.59 | — | ns |
| CE1_SET | Clock Enable to Clock (CE to CLK) | 1.41 | — | 1.23 | — | ns |
| CE2_SET | Clock Enable to Clock (ASWE to CLK) | 1.11 | — | 0.97 | — | ns |
| LSR_SET | Local Set/Reset to Clock (SYNC) (LSR to CLK) | 0.69 | — | 0.60 | — | ns |
| SEL_SET | Data Select to Clock (SEL to CLK) | 0.64 | — | 0.55 | — | ns |
| SWL2_SET | Two-level LUT to Clock (Kz[3:0] to CLK w/feedbk)* | 1.79 | — | 1.55 | — | ns |
| SWL2F5_SET | Two-level LUT to Clock (F5[A:D] to CLK w/feedbk) | 1.46 | — | 1.27 | — | ns |
| SWL3_SET | Three-level LUT to Clock (Kz[3:0] to CLK w/feedbk)* | 3.06 | — | 2.66 | — | ns |
| SWL3F5_SET | Three-level LUT to Clock (F5[A:D] to CLK w/feedbk) | 2.67 | — | 2.32 | — | ns |
| | Combinatorial Hold Times (TJ = all, VDD = all): | | | | | |
| DIN_HLD | Data In (DIN[7:0] from CLK) | 0.0 | — | 0.0 | — | ns |
| CINDIR_HLD | Carry-in from Clock, DIRECT to REGCOUT (CIN from CLK) | 0.0 | — | 0.0 | — | ns |
| CE1_HLD | Clock Enable (CE from CLK) | 0.0 | — | 0.0 | — | ns |
| CE2_HLD | Clock Enable from Clock (ASWE from CLK) | 0.0 | — | 0.0 | — | ns |
| LSR_HLD | Local Set/Reset from Clock (sync) (LSR from CLK) | 0.0 | — | 0.0 | — | ns |
| SEL_HLD | Data Select from Clock (SEL from CLK) | 0.0 | — | 0.0 | — | ns |
| — | All Others | 0.0 | — | 0.0 | — | ns |
| Output Characteristics | | | | | | |
| | Sequential Delays (TJ = +85 °C, VDD = min, VDD2 = min): | | | | | |
| LSR_DEL | Local S/R (async) to PFU Out (LSR to Q[7:0], REGCOUT) | — | 2.82 | — | 2.46 | ns |
| GSR_DEL | Global S/R to PFU Out (GSRN to Q[7:0], REGCOUT) | — | 2.21 | — | 1.92 | ns |
| REG_DEL | Clock to PFU Out—Register (CLK to Q[7:0], REGCOUT) | — | 1.22 | — | 1.06 | ns |
| LTCH_DEL | Clock to PFU Out—Latch (CLK to Q[7:0]) | — | 1.30 | — | 1.13 | ns |
| LTCHD_DEL | Transparent Latch (DIN[7:0] to Q[7:0]) | — | 1.43 | — | 1.25 | ns |

* Four-input variables' (Kz[3:0]) setup times are valid for LUTs in both F4 (four-input LUT) and F5 (five-input LUT) modes.

Note: The table shows worst-case delays. ORCA Foundry reports the delays for individual paths within a group of paths representing the same timing parameter and may accurately report delays that are less than those listed.

Timing Characteristics (continued)

Table 7. Ripple Mode PFU Timing Characteristics

OR3LxxB Commercial: VDD = 3.0 V to 3.6 V, VDD2 = 2.38 V to 2.63 V, 0 °C < TA < 70 °C; Industrial: VDD = 3.0 V to 3.6 V, VDD2 = 2.38 V to 2.63 V, -40 °C < TA < +85 °C.

| Symbol | Parameter (TJ = +85 °C, VDD = min, VDD2 = min) | -7 | | -8 | | Unit |
|-------------|---|------|-----|------|-----|------|
| | | Min | Max | Min | Max | |
| RIP_SET | Full Ripple Setup Times (byte-wide): Operands to Clock (Kz[1:0] to CLK) | 1.58 | — | 1.37 | — | ns |
| FRIP_SET | Bitwise Operands to Clock (Kz[1:0] to CLK at F[z]) | 0.90 | — | 0.78 | — | ns |
| FCIN_SET | Fast Carry-in to Clock (FCIN to CLK) | 1.21 | — | 1.05 | — | ns |
| CIN_SET | Carry-in to Clock (CIN to CLK) | 1.68 | — | 1.46 | — | ns |
| AS_SET | Add/Subtract to Clock (ASWE to CLK) | 4.70 | — | 4.09 | — | ns |
| RIPRC_SET | Operands to Clock (Kz[1:0] to CLK at REGCOUT) | 1.02 | — | 0.89 | — | ns |
| FCINRC_SET | Fast Carry-in to Clock (FCIN to CLK at REGCOUT) | 1.03 | — | 0.90 | — | ns |
| CINRC_SET | Carry-in to Clock (CIN to CLK at REGCOUT) | 1.48 | — | 1.29 | — | ns |
| ASRC_SET | Add/Subtract to Clock (ASWE to CLK at REGCOUT) | 4.51 | — | 3.92 | — | ns |
| FCINRC_HLD | Full Ripple Hold Times (TJ = all, VDD = all): Fast Carry-in from Clock (FCIN from CLK at REG- COUT) | 0.0 | — | 0.0 | — | ns |
| — | All Others | 0.0 | — | 0.0 | — | ns |
| HRIP_SET | Half Ripple Setup Times (nibble wide): Operands to Clock (Kz[1:0] to CLK) | 1.74 | — | 1.51 | — | ns |
| HFRIP_SET | Bitwise Operands to Clock (Kz[1:0] to CLK at F[z]) | 0.90 | — | 0.78 | — | ns |
| HFCIN_SET | Fast Carry-in to Clock (FCIN to CLK) | 1.21 | — | 1.05 | — | ns |
| HCIN_SET | Carry-in to Clock (CIN to CLK) | 1.68 | — | 1.46 | — | ns |
| HAS_SET | Add/Subtract to Clock (ASWE to CLK) | 4.70 | — | 4.09 | — | ns |
| HRIPRC_SET | Operands to Clock (Kz[1:0] to CLK at REGCOUT) | 1.37 | — | 1.19 | — | ns |
| HFCINRC_SET | Fast Carry-in to Clock (FCIN to CLK at REGCOUT) | 1.03 | — | 0.90 | — | ns |
| HCINRC_SET | Carry-in to Clock (CIN to CLK at REGCOUT) | 1.48 | — | 1.29 | — | ns |
| HASRC_SET | Add/Subtract to Clock (ASWE to CLK at REGCOUT) | 4.51 | — | 3.92 | — | ns |
| HFCINRC_HLD | Half Ripple Hold Times (TJ = all, VDD = all): Fast Carry-in from Clock (HFCIN from CLK at RE- COUT) | 0.0 | — | 0.0 | — | ns |
| — | All Others | 0.0 | — | 0.0 | — | ns |

Note: The table shows worst-case delay for the ripple chain. ORCA Foundry reports the delay for individual paths within the ripple chain that will be less than or equal to those listed above.

Timing Characteristics (continued)

Table 7. Ripple Mode PFU Timing Characteristics (continued)

OR3LxxB Commercial: VDD = 3.0 V to 3.6 V, VDD2 = 2.38 V to 2.63 V, 0 °C < TA < 70 °C; Industrial: VDD = 3.0 V to 3.6 V, VDD2 = 2.38 V to 2.63 V, -40 °C < TA < +85 °C.

| Symbol | Parameter (TJ = +85 °C, VDD = min, VDD2 = min) | -7 | | -8 | | Unit |
|--------------|---|-----|------|-----|------|------|
| | | Min | Max | Min | Max | |
| | Full Ripple Delays (byte-wide): | | | | | |
| RIPCO_DEL | Operands to Carry-out (Kz[1:0] to COUT) | — | 2.26 | — | 1.97 | ns |
| RIPFCO_DEL | Operands to Carry-out (Kz[1:0] to FCOUT) | — | 2.23 | — | 1.94 | ns |
| RIP_DEL | Operands to PFU Out (Kz[1:0] to F[7:0]) | — | 3.21 | — | 2.79 | ns |
| FRIP_DEL | Bitwise Operands to PFU Out (Kz[1:0] to F[z]) | — | 1.03 | — | 0.90 | ns |
| FCINCO_DEL | Fast Carry-in to Carry-out (FCIN to COUT) | — | 1.36 | — | 1.18 | ns |
| FCINFCO_DEL | Fast Carry-in to Fast Carry-out (FCIN to FCOUT) | — | 1.33 | — | 1.15 | ns |
| CINCO_DEL | Carry-in to Carry-out (CIN to COUT) | — | 1.66 | — | 1.44 | ns |
| CINFCO_DEL | Carry-in to Fast Carry-out (CIN to FCOUT) | — | 1.61 | — | 1.40 | ns |
| FCIN_DEL | Fast Carry-in PFU Out (FCIN to F[7:0]) | — | 2.03 | — | 1.77 | ns |
| CIN_DEL | Carry-in PFU Out (CIN to F[7:0]) | — | 2.65 | — | 2.31 | ns |
| ASCO_DEL | Add/Subtract to Carry-out (ASWE to COUT) | — | 4.67 | — | 4.06 | ns |
| ASFCO_DEL | Add/Subtract to Carry-out (ASWE to FCOUT) | — | 4.58 | — | 3.98 | ns |
| AS_DEL | Add/Subtract to PFU Out (ASWE to F[7:0]) | — | 5.61 | — | 4.88 | ns |
| | Half Ripple Delays (nibble wide): | | | | | |
| HRIPCO_DEL | Operands to Carry-out (Kz[1:0] to COUT) | — | 2.26 | — | 1.97 | ns |
| HRIPFCO_DEL | Operands to Fast Carry-out (Kz[1:0] to FCOUT) | — | 2.23 | — | 1.94 | ns |
| HRIP_DEL | Operands to PFU Out (Kz[1:0] to F[3:0]) | — | 2.61 | — | 2.27 | ns |
| HFRIP_DEL | Bitwise Operands to PFU Out (Kz[1:0] to F[z]) | — | 1.03 | — | 0.90 | ns |
| HFCINCO_DEL | Fast Carry-in to Carry-out (FCIN to COUT) | — | 1.36 | — | 1.18 | ns |
| HFCINFCO_DEL | Fast Carry-in to Fast Carry-out (FCIN to FCOUT) | — | 1.33 | — | 1.15 | ns |
| HCINCO_DEL | Carry-in to Carry-out (CIN to COUT) | — | 1.66 | — | 1.44 | ns |
| HCINFCO_DEL | Carry-in to Carry-out (CIN to FCOUT) | — | 1.61 | — | 1.40 | ns |
| HFCIN_DEL | Fast Carry-in PFU Out (FCIN to F[3:0]) | — | 1.72 | — | 1.50 | ns |
| HCIN_DEL | Carry-in PFU Out (CIN to F[3:0]) | — | 2.40 | — | 2.09 | ns |
| HASCO_DEL | Add/Subtract to Carry-out (ASWE to COUT) | — | 4.67 | — | 4.06 | ns |
| HASFCO_DEL | Add/Subtract to Carry-out (ASWE to FCOUT) | — | 4.58 | — | 3.98 | ns |
| HAS_DEL | Add/Subtract to PFU Out (ASWE to F[3:0]) | — | 5.00 | — | 4.34 | ns |

Note: The table shows worst-case delay for the ripple chain. ORCA Foundry reports the delay for individual paths within the ripple chain that will be less than or equal to those listed above.

Timing Characteristics (continued)

Table 8. Synchronous Memory Write Characteristics

OR3LxxB Commercial: VDD = 3.0 V to 3.6 V, VDD2 = 2.38 V to 2.63 V, 0 °C < TA < 70 °C; Industrial: VDD = 3.0 V to 3.6 V, VDD2 = 2.38 V to 2.63 V, -40 °C < TA < +85 °C.

| Symbol | Parameter | -7 | | -8 | | Unit |
|------------------------------|--|------|-------|------|-------|------|
| | | Min | Max | Min | Max | |
| Write Operation for RAM Mode | | | | | | |
| SMCLK_FRQ | Maximum Frequency | — | 266.4 | — | 333.0 | MHz |
| SMCLKL_MPW | Clock Low Time | 1.03 | — | 0.90 | — | ns |
| SMCLKH_MPW | Clock High Time | 1.96 | — | 1.71 | — | ns |
| MEM_DEL | Clock to Data Valid (CLK to F[6, 4, 2, 0])* | — | 4.39 | — | 3.82 | ns |
| Write Operation Setup Time | | | | | | |
| WA4_SET | Address to Clock (CIN to CLK) | 0.68 | — | 0.59 | — | ns |
| WA_SET | Address to Clock (DIN[7, 5, 3, 1] to CLK) | 0.35 | — | 0.30 | — | ns |
| WD_SET | Data to Clock (DIN[6, 4, 2, 0] to CLK) | 0.21 | — | 0.18 | — | ns |
| WE_SET | Write Enable (WREN) to Clock (ASWE to CLK) | 0.37 | — | 0.32 | — | ns |
| WPE0_SET | Write-port Enable 0 (WPE0) to Clock (CE to CLK) | 0.87 | — | 0.75 | — | ns |
| WPE1_SET | Write-port Enable 1 (WPE1) to Clock (LSR to CLK) | 1.10 | — | 0.95 | — | ns |
| Write Operation Hold Time | | | | | | |
| WA4_HLD | Address from Clock (CIN from CLK) | 0.0 | — | 0.0 | — | ns |
| WA_HLD | Address from Clock (DIN[7, 5, 3, 1] from CLK) | 0.0 | — | 0.0 | — | ns |
| WD_HLD | Data from Clock (DIN[6, 4, 2, 0] from CLK) | 0.33 | — | 0.29 | — | ns |
| WE_HLD | Write Enable (WREN) from Clock (ASWE from CLK) | 0.0 | — | 0.0 | — | ns |
| WPE0_HLD | Write-port Enable 0 (WPE0) from Clock (CE from CLK) | 0.0 | — | 0.0 | — | ns |
| WPE1_HLD | Write-port Enable 1 (WPE1) from Clock (LSR from CLK) | 0.0 | — | 0.0 | — | ns |

* The RAM is written on the inactive clock edge following the active edge that latches the address, data, and control signals.

Note: The table shows worst-case delays. ORCA Foundry reports the delays for individual paths within a group of paths representing the same timing parameter and may accurately report delays that are less than those listed.

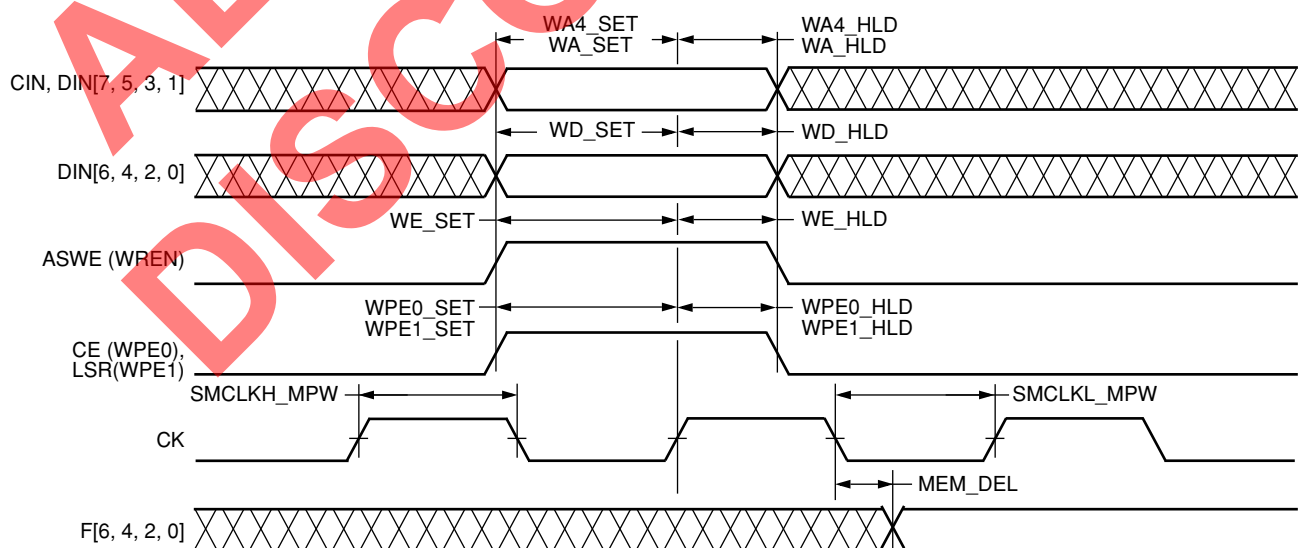

5-4621 (F)b

Figure 4. Synchronous Memory Write Characteristics

Timing Characteristics (continued)

Table 9. Synchronous Memory Read Characteristics

OR3LxxxB Commercial: VDD = 3.0 V to 3.6 V, VDD2 = 2.38 V to 2.63 V, 0 °C < TA < 70 °C; Industrial: VDD = 3.0 V to 3.6 V, VDD2 = 2.38 V to 2.63 V, -40 °C < TA < +85 °C.

| Symbol | Parameter (TJ = 85 °C, VDD = min, VDD2 = min) | -7 | | -8 | | Unit |
|---|---|------|------|------|------|------|
| | | Min | Max | Min | Max | |
| Read Operation | | | | | | |
| RA_DEL | Data Valid After Address (Kz[3:0] to F[6, 4, 2, 0]) | — | 1.03 | — | 0.90 | ns |
| RA4_DEL | Data Valid After Address (F5[A:D] to F[6, 4, 2, 0]) | — | 0.85 | — | 0.74 | ns |
| Read Operation, Clocking Data into Latch/FF | | | | | | |
| RA_SET | Address to Clock Setup Time (Kz[3:0] to CLK) | 0.90 | — | 0.78 | — | ns |
| RA4_SET | Address to Clock Setup Time (F5[A:D] to CLK) | 0.51 | — | 0.44 | — | ns |
| RA_HLD | Address from Clock Hold Time (Kz[3:0] from CLK) | 0.0 | — | 0.0 | — | ns |
| RA4_HLD | Address from Clock Hold Time (F5[A:D] from CLK) | 0.0 | — | 0.0 | — | ns |
| REG_DEL | Clock to PFU Output—Register (CLK to Q[6, 4, 2, 0]) | — | 1.22 | — | 1.06 | ns |
| SMRD_CYC | Read Cycle Delay | — | 5.38 | — | 4.68 | ns |

Note: The table shows worst-case delays. ORCA Foundry reports the delays for individual paths within a group of paths representing the same timing parameter and may accurately report delays that are less than those listed.

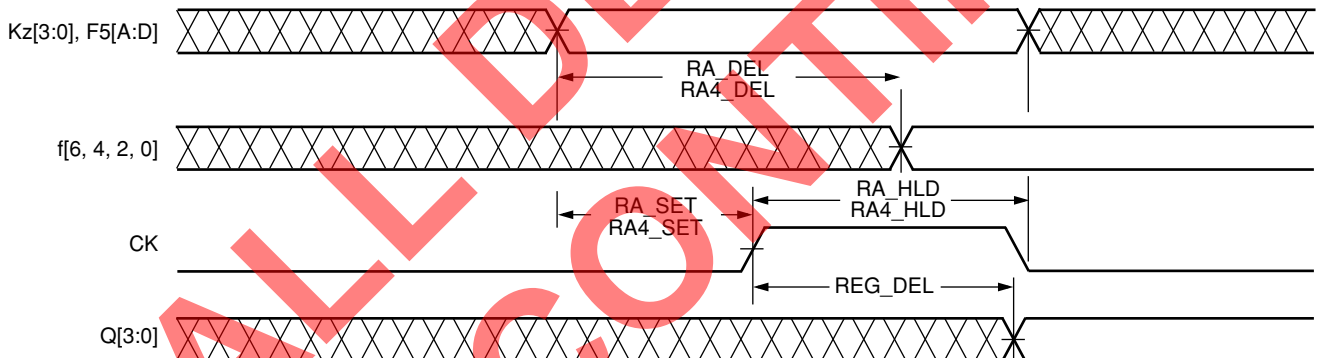

5-4622(F)

Figure 5. Synchronous Memory Read Cycle

Timing Characteristics (continued)

PLC Timing

Table 10. PFU Output MUX and Direct Routing Timing Characteristics

OR3LxxB Commercial: VDD = 3.0 V to 3.6 V, VDD2 = 2.38 V to 2.63 V, 0 °C < TA < 70 °C; Industrial: VDD = 3.0 V to 3.6 V, VDD2 = 2.38 V to 2.63 V, -40 °C < TA < +85 °C.

| Symbol | Parameter (T _J = 85 °C, VDD = min, VDD2 = min) | -7 | | -8 | | Unit |
|-------------------------------------|--|-----|------|-----|------|------|
| | | Min | Max | Min | Max | |
| PFU Output MUX (Fan-out = 1) | | | | | | |
| OMUX_DEL | Output MUX Delay (F[7:0]/Q[7:0] to O[9:0]) | — | 0.76 | — | 0.66 | ns |
| COO9_DEL | Carry-out MUX Delay (COUT to O9) | — | 0.74 | — | 0.64 | ns |
| RCOO8_DEL | Registered Carry-out MUX Delay (REGCOUT to O8) | — | 0.74 | — | 0.64 | ns |
| Direct Routing | | | | | | |
| FDBK_DEL | PFU Feedback (xSW)* | — | 0.75 | — | 0.65 | ns |
| ODIR_DEL | PFU to Orthogonal PFU Delay (xSW to xSW) | — | 0.89 | — | 0.78 | ns |
| DDIR_DEL | PFU to Diagonal PFU Delay (xBID to xSW) | — | 1.61 | — | 1.40 | ns |

* This is general feedback using switching segments. See the combinatorial PFU timing table for softwired look-up table feedback timing.

SLIC Timing

Table 11. Supplemental Logic and Interconnect Cell Timing Characteristics

OR3LxxB Commercial: VDD = 3.0 V to 3.6 V, VDD2 = 2.38 V to 2.63 V, 0 °C < TA < 70 °C; Industrial: VDD = 3.0 V to 3.6 V, VDD2 = 2.38 V to 2.63 V, -40 °C < TA < +85 °C.

| Symbol | Parameter (T _J = 85 °C, VDD = min, VDD2 = min) | -7 | | -8 | | Unit |
|------------------------|--|-----|------|-----|------|------|
| | | Min | Max | Min | Max | |
| 3-Statable BIDs | | | | | | |
| BUF_DEL | BIDI Delay (BRx to BLx, BLx to BRx) | — | 0.70 | — | 0.61 | ns |
| OBUF_DEL | BIDI Delay (Ox to BRx, Ox to BLx) | — | 0.61 | — | 0.53 | ns |
| TRI_DEL | BIDI 3-state Enable/Disable Delay (TRI to BL, BR) | — | 1.18 | — | 1.03 | ns |
| DECTRI_DEL | BIDI 3-state Enable/Disable Delay (BL, BR via DEC, TRI to BL, BR) | — | 2.01 | — | 1.75 | ns |
| Decoder | | | | | | |
| DEC98_DEL | Decoder Delay (BR[9:8], BL[9:8] to DEC) | — | 1.16 | — | 1.01 | ns |
| DEC_DEL | Decoder Delay (BR[7:0], BL[7:0] to DEC) | — | 1.29 | — | 1.12 | ns |

Timing Characteristics (continued)

PIO Timing.

Table 12. Programmable I/O Timing Characteristics

OR3LxxB Commercial: VDD = 3.0 V to 3.6 V, VDD2 = 2.38 V to 2.63 V, 0 °C < TA < 70 °C; Industrial: VDD = 3.0 V to 3.6 V, VDD2 = 2.38 V to 2.63 V, -40 °C < TA < +85 °C.

| Symbol | Parameter | -7 | | -8 | | Unit |
|---|--|-------|-------|-------|-------|------|
| | | Min | Max | Min | Max | |
| Input Delays (TJ = 85 °C, VDD = min, VDD2 = min) | | | | | | |
| IN_RIS | Input Rise Time | — | 575 | — | 500 | ns |
| IN_FAL | Input Fall Time | — | 575 | — | 500 | ns |
| CKIN_DEL IN_DEL IND_DEL | PIO Direct Delays: | | | | | |
| | Pad to In (pad to CLK IN) | — | 0.77 | — | 0.55 | ns |
| | Pad to In (pad to IN1, IN2) | — | 1.35 | — | 1.07 | ns |
| | Pad to In Delayed (pad to IN1, IN2) | — | 11.55 | — | 9.89 | ns |
| LATCH_DEL LATCHD_DEL | PIO Transparent Latch Delays: | | | | | |
| | Pad to In (pad to IN1, IN2) | — | 2.79 | — | 2.42 | ns |
| | Pad to In Delayed (pad to IN1, IN2) | — | 12.46 | — | 10.87 | ns |
| INREG_SET INREGD_SET INREG_SET INREGD_SET INCE_SET INLSR_SET | Input Latch/FF Setup Timing: | | | | | |
| | Pad to ExpressCLK (fast-capture latch/FF) | 4.54 | — | 2.62 | — | ns |
| | Pad Delayed to ExpressCLK (fast-capture latch/FF) | 14.53 | — | 11.63 | — | ns |
| | Pad to Clock (input latch/FF) | 0.65 | — | 0.46 | — | ns |
| | Pad Delayed to Clock (input latch/FF) | 10.90 | — | 9.50 | — | ns |
| | Clock Enable to Clock (CE to CLK) | 0.92 | — | 0.82 | — | ns |
| | Local Set/Reset (sync) to Clock (LSR to CLK) | 0.81 | — | 0.73 | — | ns |
| INREG_HLD INREGD_HLD INREG_HLD INREGD_HLD INCE_HLD INLSR_HLD | Input FF/Latch Hold Timing: | | | | | |
| | Pad from ExpressCLK (fast-capture latch/FF) | 0.0 | — | 0.0 | — | ns |
| | Pad Delayed from ExpressCLK (fast-capture latch/FF) | 0.0 | — | 0.0 | — | ns |
| | Pad from Clock (input latch/FF) | 0.0 | — | 0.0 | — | ns |
| | Pad Delayed from Clock (input latch/FF) | 0.0 | — | 0.0 | — | ns |
| | Clock Enable from Clock (CE from CLK) | 0.0 | — | 0.0 | — | ns |
| | Local Set/Reset (sync) from Clock (LSR from CLK) | 0.0 | — | 0.0 | — | ns |
| INREG_DEL INLTCH_DEL INLSR_DEL INLSRL_DEL INGSR_DEL | Clock-to-in Delay (FF CLK to IN1, IN2) | — | 1.94 | — | 1.68 | ns |
| | Clock-to-in Delay (latch CLK to IN1, IN2) | — | 1.94 | — | 1.68 | ns |
| | Local S/R (async) to IN (LSR to IN1, IN2) | — | 2.95 | — | 2.55 | ns |
| | Local S/R (async) to IN (LSR to IN1, IN2) Latch/FF in Latch Mode | — | 2.64 | — | 2.30 | ns |
| | Global S/R to In (GSRN to IN1, IN2) | — | 2.69 | — | 2.34 | ns |

Note: The delays for all input buffers assume an input rise/fall time of <1 V/ns.

Timing Characteristics (continued)

Table 12. Programmable I/O Timing Characteristics (continued)

OR3LxxB Commercial: VDD = 3.0 V to 3.6 V, VDD2 = 2.38 V to 2.63 V, 0 °C < TA < 70 °C; Industrial: VDD = 3.0 V to 3.6 V, VDD2 = 2.38 V to 2.63 V, -40 °C < TA < +85 °C.

| Symbol | Parameter | -7 | | -8 | | Unit |
|--|--|------|-------|------|-------|------|
| | | Min | Max | Min | Max | |
| Output Delays (T _J = 85 °C, VDD = min, CL = 50 pF) | | | | | | |
| | Output to Pad (OUT2, OUT1 direct to pad): | | | | | |
| OUTF_DEL | Fast | — | 3.79 | — | 3.21 | ns |
| OUTSL_DEL | Slewlim | — | 4.71 | — | 3.91 | ns |
| OUTSI_DEL | Sinklim | — | 10.14 | — | 8.84 | ns |
| | 3-state Enable/Disable Delay (TS to pad): | | | | | |
| TSF_DEL | Fast | — | 3.86 | — | 3.29 | ns |
| TSSL_DEL | Slewlim | — | 4.66 | — | 3.99 | ns |
| TSSI_DEL | Sinklim | — | 10.24 | — | 8.92 | ns |
| | Local Set/Reset (async) to Pad (LSR to pad): | | | | | |
| OUTLSRF_DEL | Fast | — | 5.70 | — | 4.90 | ns |
| OUTLSRSL_DEL | Slewlim | — | 6.58 | — | 5.60 | ns |
| OUTLSRSI_DEL | Sinklim | — | 12.09 | — | 10.52 | ns |
| | Global Set/Reset to Pad (GSRN to pad): | | | | | |
| OUTGSRF_DEL | Fast | — | 5.05 | — | 4.81 | ns |
| OUTGSRSL_DEL | Slewlim | — | 5.75 | — | 5.51 | ns |
| OUTGSRSI_DEL | Sinklim | — | 10.60 | — | 10.43 | ns |
| | Output FF Setup Timing: | | | | | |
| OUTE_SET | Out to ExpressCLK (OUT[2:1] to ECLK) | 0.0 | — | 0.0 | — | ns |
| OUT_SET | Out to Clock (OUT[2:1] to CLK) | 0.0 | — | 0.0 | — | ns |
| OUTCE_SET | Clock Enable to Clock (CE to CLK) | 0.44 | — | 0.39 | — | ns |
| OUTLSR_SET | Local Set/Reset (sync) to Clock (LSR to CLK) | 0.05 | — | 0.04 | — | ns |
| | Output FF Hold Timing: | | | | | |
| OUTE_HLD | Out from ExpressCLK (OUT[2:1] from ECLK) | 0.32 | — | 0.28 | — | ns |
| OUT_HLD | Out from Clock (OUT[2:1] from CLK) | 0.32 | — | 0.28 | — | ns |
| OUTCE_HLD | Clock Enable from Clock (CE from CLK) | 0.0 | — | 0.0 | — | ns |
| OUTLSR_HLD | Local Set/Reset (sync) from Clock (LSR from CLK) | 0.0 | — | 0.0 | — | ns |
| | Clock to Pad Delay (ECLK, SCLK to pad): | | | | | |
| OUTREGF_DEL | Fast | — | 4.67 | — | 4.02 | ns |
| OUTREGSL_DEL | Slewlim | — | 5.55 | — | 4.72 | ns |
| OUTREGSI_DEL | Sinklim | — | 11.05 | — | 9.64 | ns |
| OD_DEL | Additional Delay If Using Open Drain | — | 0.11 | — | 0.09 | ns |

Note: The delays for all input buffers assume an input rise/fall time of <1 V/ns

Timing Characteristics (continued)

Table 12. Programmable I/O Timing Characteristics (continued)

OR3LxxxB Commercial: VDD = 3.0 V to 3.6 V, VDD2 = 2.38 V to 2.63 V, 0 °C < TA < 70 °C; Industrial: VDD = 3.0 V to 3.6 V, VDD2 = 2.38 V to 2.63 V, -40 °C < TA < +85 °C.

| Symbol | Parameter | -7 | | -8 | | Unit |
|-------------------------------|--|------|-------|------|-------|------|
| | | Min | Max | Min | Max | |
| PIO Logic Block Delays | | | | | | |
| | Out to Pad (OUT[2:1] via logic to pad): | | | | | |
| OUTLF_DEL | Fast | — | 3.79 | — | 3.21 | ns |
| OUTLSL_DEL | Slewlum | — | 4.71 | — | 3.91 | ns |
| OUTLSI_DEL | Sinklum | — | 10.14 | — | 8.84 | ns |
| | Outreg to Pad (OUTREG via logic to pad): | | | | | |
| OUTRF_DEL | Fast | — | 4.67 | — | 4.02 | ns |
| OUTRSL_DEL | Slewlum | — | 5.55 | — | 4.72 | ns |
| OUTRSI_DEL | Sinklum | — | 11.05 | — | 9.64 | ns |
| | Clock to Pad (ECLK, CLK via logic to pad): | | | | | |
| OUTCF_DEL | Fast | — | 4.54 | — | 3.90 | ns |
| OUTCSL_DEL | Slewlum | — | 5.44 | — | 4.60 | ns |
| OUTCSI_DEL | Sinklum | — | 10.92 | — | 9.53 | ns |
| 3-State FF Delays | | | | | | |
| | 3-state Enable/Disable Delay (TS direct to pad): | | | | | |
| TSF_DEL | Fast | — | 3.86 | — | 3.29 | ns |
| TSSL_DEL | Slewlum | — | 4.66 | — | 3.99 | ns |
| TSSI_DEL | Sinklum | — | 10.24 | — | 8.92 | ns |
| | Local Set/Reset (async) to Pad (LSR to pad): | | | | | |
| TLSRF_DEL | Fast | — | 5.13 | — | 4.38 | ns |
| TLSRSL_DEL | Slewlum | — | 5.93 | — | 5.08 | ns |
| TLSRSI_DEL | Sinklum | — | 11.51 | — | 10.01 | ns |
| | Global Set/Reset to Pad (GSRN to pad): | | | | | |
| TSGRF_DEL | Fast | — | 4.65 | — | 4.28 | ns |
| TSGRSL_DEL | Slewlum | — | 5.35 | — | 4.98 | ns |
| TSGRSI_DEL | Sinklum | — | 10.20 | — | 9.91 | ns |
| | 3-State FF Setup Timing: | | | | | |
| TSE_SET | TS to ExpressCLK (TS to ECLK) | 0.0 | — | 0.0 | — | ns |
| TS_SET | TS to Clock (TS to CLK) | 0.0 | — | 0.0 | — | ns |
| TLSR_SET | Local Set/Reset (sync) to Clock (LSR to CLK) | 0.0 | — | 0.0 | — | ns |
| | 3-State FF Hold Timing: | | | | | |
| TSE_HLD | TS from ExpressCLK (TS from ECLK) | 0.34 | — | 0.30 | — | ns |
| TS_HLD | TS from Clock (TS from CLK) | 0.34 | — | 0.30 | — | ns |
| TLSR_HLD | Local Set/Reset (sync) from Clock (LSR from CLK) | 0.0 | — | 0.0 | — | ns |
| | Clock to Pad Delay (ECLK, SCLK to pad): | | | | | |
| TSREGF_DEL | Fast | — | 4.09 | — | 3.49 | ns |
| TSREGSL_DEL | Slewlum | — | 4.90 | — | 4.19 | ns |
| TSREGSI_DEL | Sinklum | — | 10.48 | — | 9.12 | ns |

Note: The delays for all input buffers assume an input rise/fall time of <1 V/ns.

Timing Characteristics (continued)

Special Function Blocks Timing

Table 13. Microprocessor Interface (MPI) Timing Characteristics

OR3LxxB Commercial: VDD = 3.0 V to 3.6 V, VDD2 = 2.38 V to 2.63 V, 0 °C < TA < 70 °C; Industrial: VDD = 3.0 V to 3.6 V, VDD2 = 2.38 V to 2.63 V, -40 °C < TA < +85 °C.

| Symbol | Parameter | -7 | | -8 | | Unit |
|---|---|------|------|------|------|------|
| | | Min | Max | Min | Max | |
| PowerPC Interface Timing (TJ = 85 °C, VDD = min, VDD2 = min) | | | | | | |
| TA_DEL | Transfer Acknowledge Delay (CLK to \overline{TA}) | — | 9.50 | — | 8.30 | ns |
| BI_DEL | Burst Inhibit Delay (CLK to BIN) | — | 9.40 | — | 8.20 | ns |
| TA_DELZ | Transfer Acknowledge Delay to High Impedance ² | — | — | — | — | ns |
| BI_DELZ | Burst Inhibit Delay to High Impedance ² | — | — | — | — | ns |
| WD_SET | Write Data Setup Time (data to \overline{TS}) | 0.0 | — | 0.0 | — | ns |
| WD_HLD | Write Data Hold Time (data from CLK while $\overline{MPI_ACK}$ low) | 0.0 | — | 0.0 | — | ns |
| A_SET | Address Setup Time (addr to \overline{TS}) | 0.0 | — | 0.0 | — | ns |
| A_HLD | Address Hold Time (addr from CLK while $\overline{MPI_ACK}$ low) | 0.0 | — | 0.0 | — | ns |
| RW_SET | Read/Write Setup Time (R/W to \overline{TS}) | 0.0 | — | 0.0 | — | ns |
| RW_HLD | Read/Write Hold Time (R/W from CLK while $\overline{MPI_ACK}$ low) | 0.0 | — | 0.0 | — | ns |
| CS_SET | Chip Select Setup Time ($\overline{CS0}$, $\overline{CS1}$ to \overline{TS}) | 0.46 | — | 0.40 | — | ns |
| CS_HLD | Chip Select Hold Time ($\overline{CS0}$, $\overline{CS1}$ from CLK) | 0.0 | — | 0.0 | — | ns |
| UA_DEL | User Address Delay (pad to UA[3:0]) | — | 2.20 | — | 1.90 | ns |
| URDWR_DEL | User Read/Write Delay (pad to URDWR_DEL) | — | 4.60 | — | 4.00 | ns |
| i960 Interface Timing (TJ = 85 °C, VDD = min, VDD2 = min) | | | | | | |
| ADSN_SET | Addr/Data Select to ALE (\overline{ADS} to ALE low) | — | — | — | — | ns |
| ADSN_HLD | Addr/Data Select to ALE (\overline{ADS} from ALE low) | 0.0 | — | 0.0 | — | ns |
| RDYRCV_DEL | Ready/Receive Delay (CLK to RDYRCV) | — | 9.50 | — | 8.30 | ns |
| RDYRCV_DELZ | Ready/Receive Delay to High Impedance ² | — | — | — | — | ns |
| WD_SET | Write Data Setup Time ³ | — | — | — | — | ns |
| WD_HLD | Write Data Hold Time ⁴ | — | — | — | — | ns |
| A_SET | Address Setup Time (addr to ALE low) | — | 0.12 | — | 0.10 | ns |
| A_HLD | Address Hold Time (addr from ALE low) | 0.80 | — | 0.70 | — | ns |
| BE_SET | Byte Enable Setup Time ($\overline{BE0}$, $\overline{BE1}$ to ALE low) | — | 0.12 | — | 0.10 | ns |
| BE_HLD | Byte Enable Hold Time ($\overline{BE0}$, $\overline{BE1}$ from ALE low) | 0.80 | — | 0.70 | — | ns |

- For user system flexibility, $\overline{CS0}$ and $\overline{CS1}$ may be set up to any one of the three rising clock edges, beginning with the rising clock edge when $\overline{MPI_STRB}$ is low. If both chip selects are valid and the setup time is met, the MPI will latch the chip select state, and $\overline{CS0}$ and $\overline{CS1}$ may go inactive before the end of the read/write cycle.
- 0.5 $\overline{MPI_CLK}$.
- Write data and $\overline{W/R}$ have to be valid starting from the clock cycle after both \overline{ADS} and $\overline{CS0}$ and $\overline{CS1}$ are recognized.
- Write data and $\overline{W/R}$ have to be held until the microprocessor receives a valid RDYRCV.
- User Logic Delay has no predefined value. The user must generate a UEND signal to complete the cycle.
- USTART_DEL is based on the falling clock edge.
- There is no specific time associated with this delay. The user must assert UEND low to complete this cycle.
- The user must assert interrupt request low until a service routine is executed.
- This should be at least one $\overline{MPI_CLK}$ cycle.
- User should set up read data so that RDS_SET and RDS_HLD can be met for the microprocessor timing.

Notes:

Read and write descriptions are referenced to the host microprocessor; e.g., a read is a read by the host (*PowerPC*, *i960*) from the FPGA. *PowerPC* and *i960* timings to/from the clock are relative to the clock at the FPGA microprocessor interface clock pin ($\overline{MPI_CLK}$).

Timing Characteristics (continued)

Table 13. Microprocessor Interface (MPI) Timing Characteristics (continued)

OR3LxxB Commercial: VDD = 3.0 V to 3.6 V, VDD2 = 2.38 V to 2.63 V, 0 °C < TA < 70 °C; Industrial: VDD = 3.0 V to 3.6 V, VDD2 = 2.38 V to 2.63 V, -40 °C < TA < +85 °C.

| Symbol | Parameter | -7 | | -8 | | Unit |
|--|---|------|------|------|------|------|
| | | Min | Max | Min | Max | |
| i960 Interface Timing (TJ = 85 °C, VDD = min, VDD2 = min) (continued) | | | | | | |
| RW_SET | Read/Write Setup Time ³ | — | — | — | — | ns |
| RW_HLD | Read/Write Hold Time ⁴ | — | — | — | — | ns |
| CS_SET | Chip Select Setup Time ($\overline{CS0}$, CS1 to CLK) ¹ | 0.80 | — | 0.70 | — | ns |
| CS_HLD | Chip Select Hold Time ($\overline{CS0}$, CS1 from CLK) ¹ | 0.0 | — | 0.0 | — | ns |
| UA_DEL | User Address Delay (CLK low to UA[3:0]) | — | 6.21 | — | 5.40 | ns |
| URDWR_DEL | User Read/Write Delay (pad to URDWR_DEL) | — | 4.60 | — | 4.00 | ns |
| User Logic Delay⁵ | | | | | | |
| USTART_DEL | User Start Delay (MPI_CLK falling to USTART) ⁶ | — | 3.80 | — | 3.30 | ns |
| USTARTCLR_DEL | User Start Clear Delay (MPI_CLK to USTART) | — | 6.90 | — | 6.00 | ns |
| UEND_DEL | User End Delay (USTART low to UEND low) ⁷ | — | — | — | — | ns |
| Synchronous User Timing | | | | | | |
| UEND_SET | User End Setup (UEND to MPI_CLK) | 0.0 | — | 0.0 | — | ns |
| UEND_HLD | User End Hold (UEND to MPI_CLK) | 1.40 | — | 1.20 | — | ns |
| RDS_SET | Data Setup for Read (D[7:0] to MPI_CLK) ⁹ | — | — | — | — | ns |
| RDS_HLD | Data Hold for Read (D[7:0] from MPI_CLK) ⁹ | — | — | — | — | ns |
| Asynchronous User Timing | | | | | | |
| RDA_DEL | User End to Read Data Delay (UEND to D[7:0]) ¹⁰ | — | — | — | — | ns |
| RDA_HLD | Data Hold from User Start (low) ⁹ | — | — | — | — | ns |
| TUIRQ_PW | Interrupt Request Pulse Width ⁸ | — | — | — | — | ns |

1. For user system flexibility, $\overline{CS0}$ and CS1 may be set up to any one of the three rising clock edges, beginning with the rising clock edge when MPI_STRB is low. If both chip selects are valid and the setup time is met, the MPI will latch the chip select state, and $\overline{CS0}$ and CS1 may go inactive before the end of the read/write cycle.

2. 0.5 MPI_CLK.

3. Write data and W/R have to be valid starting from the clock cycle after both \overline{ADS} and $\overline{CS0}$ and CS1 are recognized.

4. Write data and W/R have to be held until the microprocessor receives a valid RDYRCV.

5. User Logic Delay has no predefined value. The user must generate a UEND signal to complete the cycle.

6. USTART_DEL is based on the falling clock edge.

7. There is no specific time associated with this delay. The user must assert UEND low to complete this cycle.

8. The user must assert interrupt request low until a service routine is executed.

9. This should be at least one MPI_CLK cycle.

10. User should set up read data so that RDS_SET and RDS_HLD can be met for the microprocessor timing.

Notes:

Read and write descriptions are referenced to the host microprocessor; e.g., a read is a read by the host (PowerPC, i960) from the FPGA.

PowerPC and i960 timings to/from the clock are relative to the clock at the FPGA microprocessor interface clock pin (MPI_CLK).

Timing Characteristics (continued)

Clock Timing

Table 14. ExpressCLK (ECLK) and Fast Clock (FCLK) Timing Characteristics

OR3LxxB Commercial: VDD = 3.0 V to 3.6 V, VDD2 = 2.38 V to 2.63 V, 0 °C < TA < 70 °C; Industrial: VDD = 3.0 V to 3.6 V, VDD2 = 2.38 V to 2.63 V, -40 °C < TA < +85 °C.

| Symbol | Device (T _J = 85 °C, VDD = min, VDD2 = min) | -7 | | -8 | | Unit |
|-----------|---|------|--------------|------|--------------|----------|
| | | Min | Max | Min | Max | |
| ECLKC_DEL | Clock Control Timing Delay Through CLKCNTRL (input from corner) | 0.31 | — | 0.27 | — | ns |
| ECLKM_DEL | Delay Through CLKCNTRL (input from internal clock controller PAD) | 1.06 | — | 0.92 | — | ns |
| OFFM_SET | Clock Shutoff Timing: Setup from Middle ECLK (shut off to CLK) | 0.41 | — | 0.36 | — | ns |
| OFFM_HLD | Hold from Middle ECLK (shut off from CLK) | 0.0 | — | 0.0 | — | ns |
| OFFC_SET | Setup from Corner ECLK (shut off to CLK) | 0.41 | — | 0.36 | — | ns |
| OFFC_HLD | Hold from Corner ECLK (shut off from CLK) | 0.0 | — | 0.0 | — | ns |
| ECLKM_DEL | ECLK Delay (middle pad): OR3L165 OR3L225 | — | 2.32 2.37 | — | 2.02 2.07 | ns ns |
| ECLKC_DEL | ECLK Delay (corner pad): OR3L165 OR3L225 | — | 5.02 5.27 | — | 4.23 4.45 | ns ns |
| FCLKM_DEL | FCLK Delay (middle pad): OR3L165 OR3L225 | — | 5.74 6.04 | — | 5.06 5.35 | ns ns |
| FCLKC_DEL | FCLK Delay (corner pad): OR3L165 OR3L225 | — | 8.41 8.89 | — | 7.24 7.68 | ns ns |

Notes:

The ECLK delays are to all of the PICs on one side of the device for middle pin input, or two sides of the device for corner pin input. The delay includes both the input buffer delay and the clock routing to the PIC clock input.

The FCLK delays are for a fully routed clock tree that uses the ExpressCLK input into the fast clock network. It includes both the input buffer delay and the clock routing to the PFU CLK input. The delay will be reduced if any of the clock branches are not used.

Timing Characteristics (continued)**Table 15. General-Purpose Clock Timing Characteristics (Internally Generated Clock)**

OR3LxxB Commercial: VDD = 3.0 V to 3.6 V, VDD2 = 2.38 V to 2.63 V, 0 °C < TA < 70 °C; Industrial: VDD = 3.0 V to 3.6 V, VDD2 = 2.38 V to 2.63 V, -40 °C < TA < +85 °C.

| Symbol | Device (T _J = 85 °C, VDD = min, VDD2 = min) | -7 | | -8 | | Unit |
|---------|---|-----|------|-----|------|------|
| | | Min | Max | Min | Max | |
| CLK_DEL | OR3L165 | — | 4.56 | — | 3.98 | ns |
| CLK_DEL | OR3L225 | — | 4.58 | — | 3.99 | ns |

Notes:

This table represents the delay for an internally generated clock from the clock tree input in one of the four middle PICs (using pSW routing) on any side of the device which is then distributed to the PFU/PIO clock inputs. If the clock tree input used is located at any other PIC, see the results reported by ORCA Foundry.

This clock delay is for a fully routed clock tree that uses the general clock network. The delay will be reduced if any of the clock branches are not used. See pin-to-pin timing in Table 18 for clock delays of clocks input on general I/O pins.

ALL DEVICES
DISCONTINUED

Timing Characteristics (continued)

Table 16. OR3Lxxx ExpressCLK to Output Delay (Pin-to-Pin)

OR3Lxxx Commercial: VDD = 3.0 V to 3.6 V, VDD2 = 2.38 V to 2.63 V, 0 °C < TA < 70 °C; Industrial: VDD = 3.0 V to 3.6 V, VDD2 = 2.38 V to 2.63 V, -40 °C < TA < +85 °C.

| Description (T _J = 85 °C, VDD = min, VDD2 = min) | Device | -7 | | -8 | | Unit |
|--|---------|-----|-------|-----|-------|------|
| | | Min | Max | Min | Max | |
| ECLK Middle Input Pin→OUTPUT Pin (Fast) | OR3L165 | — | 6.94 | — | 5.84 | ns |
| | OR3L225 | — | 6.99 | — | 5.89 | ns |
| ECLK Middle Input Pin→OUTPUT Pin (Slewlim) | OR3L165 | — | 7.79 | — | 6.64 | ns |
| | OR3L225 | — | 7.84 | — | 6.69 | ns |
| ECLK Middle Input Pin→OUTPUT Pin (Sinklim) | OR3L165 | — | 12.91 | — | 11.08 | ns |
| | OR3L225 | — | 12.96 | — | 11.13 | ns |
| Additional Delay if ECLK Corner Pin Used | OR3L165 | — | 2.70 | — | 2.21 | ns |
| | OR3L225 | — | 2.90 | — | 2.38 | ns |

Notes:

Timing is without the use of the PCM.

This clock delay is for a fully routed clock tree that uses the ExpressCLK network. It includes both the input buffer delay, the clock routing to the PIO CLK input, the clock→Q of the FF, and the delay through the output buffer. The given timing requires that the input clock pin be located at one of the six ExpressCLK inputs of the device, and that a PIO FF be used.

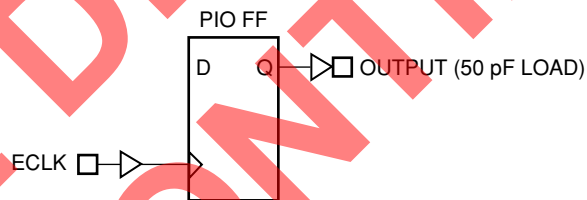

Figure 6. ExpressCLK to Output Delay

5-4846 (F)c

Timing Characteristics (continued)

Table 17. OR3Lxxx Fast Clock (FCLK) to Output Delay (Pin-to-Pin)

OR3Lxxx Commercial: VDD = 3.0 V to 3.6 V, VDD2 = 2.38 V to 2.63 V, 0 °C < TA < 70 °C; Industrial: VDD = 3.0 V to 3.6 V, VDD2 = 2.38 V to 2.63 V, -40 °C < TA < +85 °C.

| Description (T _J = 85 °C, VDD = min, VDD2 = min) | Device | -7 | | -8 | | Unit |
|---|---------|-----|-------|-----|-------|------|
| | | Min | Max | Min | Max | |
| Output Not on Same Side of Device as Input Clock (Fast Clock Delays Using ExpressCLK Inputs) | | | | | | |
| ECLK Middle Input Pin →OUTPUT Pin (Fast) | OR3L165 | — | 10.37 | — | 8.89 | ns |
| | OR3L225 | — | 10.66 | — | 9.17 | ns |
| ECLK Middle Input Pin →OUTPUT Pin (Slewlim) | OR3L165 | — | 11.22 | — | 9.69 | ns |
| | OR3L225 | — | 11.54 | — | 9.97 | ns |
| ECLK Middle Input Pin →OUTPUT Pin (Sinklim) | OR3L165 | — | 16.33 | — | 14.13 | ns |
| | OR3L225 | — | 16.63 | — | 14.41 | ns |
| Additional Delay if ECLK Corner Pin Used | OR3L165 | — | 2.66 | — | 2.17 | ns |
| | OR3L225 | — | 2.85 | — | 2.33 | ns |

Notes:

Timing is without the use of the PCM.

This clock delay is for a fully routed clock tree that uses the primary clock network. It includes both the input buffer delay, the clock routing to the PIO CLK input, the clock→Q of the FF, and the delay through the output buffer. The delay will be reduced if any of the clock branches are not used. The given timing requires that the input clock pin be located at one of the six ExpressCLK inputs of the device and that a PIO FF be used.

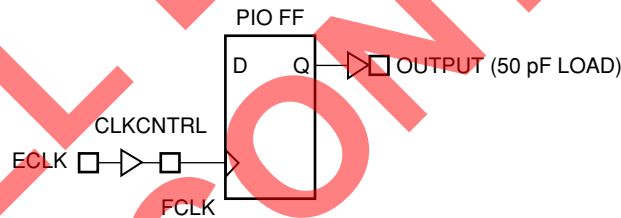

5-4846(F).b

Figure 7. Fast Clock to Output Delay

Timing Characteristics (continued)

Table 18. OR3Lxxx General System Clock (SCLK) to Output Delay (Pin-to-Pin)

OR3LxxB Commercial: VDD = 3.0 V to 3.6 V, VDD2 = 2.38 V to 2.63 V, 0 °C < TA < 70 °C; Industrial: VDD = 3.0 V to 3.6 V, VDD2 = 2.38 V to 2.63 V, -40 °C < TA < +85 °C.

| Description (T _J = 85 °C, V _{DD} = min, V _{DD2} = min) | Device | -7 | | -8 | | Unit |
|---|---------|-----|-------|-----|-------|------|
| | | Min | Max | Min | Max | |
| Output On Same Side of Device As Input Clock (System Clock Delays Using General User I/O Inputs) | | | | | | |
| Clock Input Pin (mid-PIC) →OUTPUT Pin (Fast) | OR3L165 | — | 11.81 | — | 10.06 | ns |
| | OR3L225 | — | 12.32 | — | 10.54 | ns |
| Clock Input Pin (mid-PIC) →OUTPUT Pin (Slewlim) | OR3L165 | — | 12.66 | — | 11.85 | ns |
| | OR3L225 | — | 13.16 | — | 11.34 | ns |
| Clock Input Pin (mid-PIC) →OUTPUT Pin (Sinklim) | OR3L165 | — | 17.78 | — | 15.29 | ns |
| | OR3L225 | — | 18.28 | — | 15.78 | ns |
| Additional Delay if Non-mid-PIC Used as Clock Pin | OR3L165 | — | 1.04 | — | 1.03 | ns |
| | OR3L225 | — | 1.43 | — | 1.43 | ns |
| Output Not on Same Side of Device As Input Clock (System Clock Delays Using General User I/O Inputs) | | | | | | |
| Additional Delay if Output Not on Same Side as Input Clock Pin | OR3L165 | — | 1.04 | — | 1.03 | ns |
| | OR3L225 | — | 1.43 | — | 1.43 | ns |

Note: This clock delay is for a fully routed clock tree that uses the primary clock network. It includes both the input buffer delay, the clock routing to the PIO CLK input, the clock →Q of the FF, and the delay through the output buffer. The delay will be reduced if any of the clock branches are not used. The given timing requires that the input clock pin be located at one of the four center PICs on any side of the device and that a PIO FF be used. For clock pins located at any other PIO, see the results reported by ORCA Foundry.

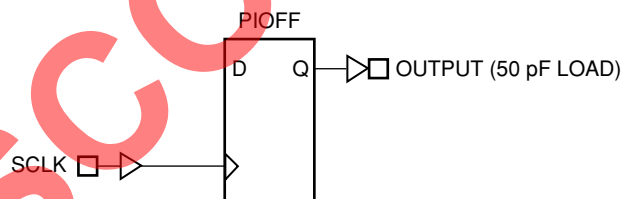

Figure 8. System Clock to Output Delay

5-4846(F)

Timing Characteristics (continued)**Table 19. OR3Lxxx Input to ExpressCLK (ECLK) Fast-Capture Setup/Hold Time (Pin-to-Pin)**

OR3Lxxx Commercial: VDD = 3.0 V to 3.6 V, VDD2 = 2.38 V to 2.63 V, 0 °C < TA < 70 °C; Industrial: VDD = 3.0 V to 3.6 V, VDD2 = 2.38 V to 2.63 V, -40 °C < TA < +85 °C.

| Description (T _J = 85 °C, V _{DD} = min, V _{DD2} = min) | Device | -7 | | -8 | | Unit |
|--|---------|-------|-----|------|-----|------|
| | | Min | Max | Min | Max | |
| Input to ECLK Setup Time (middle ECLK pin) | OR3L165 | 2.63 | — | 0.96 | — | ns |
| | OR3L225 | 2.61 | — | 0.95 | — | ns |
| Input to ECLK Setup Time (middle ECLK pin, delayed data input) | OR3L165 | 12.62 | — | 9.97 | — | ns |
| | OR3L225 | 12.60 | — | 9.96 | — | ns |
| Input to ECLK Setup Time (corner ECLK pin) | OR3L165 | 0.0 | — | 0.0 | — | ns |
| | OR3L225 | 0.0 | — | 0.0 | — | ns |
| Input to ECLK Setup Time (corner ECLK pin, delayed data input) | OR3L165 | 10.33 | — | 8.09 | — | ns |
| | OR3L225 | 10.13 | — | 7.93 | — | ns |
| Input to ECLK Hold Time (middle ECLK pin) | OR3L165 | 0.0 | — | 0.0 | — | ns |
| | OR3L225 | 0.0 | — | 0.0 | — | ns |
| Input to ECLK Hold Time (middle ECLK pin, delayed data input) | OR3L165 | 0.0 | — | 0.0 | — | ns |
| | OR3L225 | 0.0 | — | 0.0 | — | ns |

Notes:

The pin-to-pin timing parameters in this table should be used instead of results reported by ORCA Foundry.

The ECLK delays are to all of the PIOs on one side of the device for middle pin input, or two sides of the device for corner pin input. The delay includes both the input buffer delay and the clock routing to the PIO clock input.

Timing Characteristics (continued)

Table 19. OR3Lxxx Input to ExpressCLK (ECLK) Fast-Capture Setup/Hold Time (Pin-to-Pin) (continued)

OR3LxxB Commercial: VDD = 3.0 V to 3.6 V, VDD2 = 2.38 V to 2.63 V, 0 °C < TA < 70 °C; Industrial: VDD = 3.0 V to 3.6 V, VDD2 = 2.38 V to 2.63 V, -40 °C < TA < +85 °C.

| Description (T _J = 85 °C, VDD = min, VDD2 = min) | Device | -7 | | -8 | | Unit |
|--|---------|-----|-----|-----|-----|------|
| | | Min | Max | Min | Max | |
| Input to ECLK Hold Time (corner ECLK pin) | OR3L165 | 0.0 | — | 0.0 | — | ns |
| | OR3L225 | 0.0 | — | 0.0 | — | ns |
| Input to ECLK Hold Time (corner ECLK pin, delayed data input) | OR3L165 | 0.0 | — | 0.0 | — | ns |
| | OR3L225 | 0.0 | — | 0.0 | — | ns |

Notes:

The pin-to-pin timing parameters in this table should be used instead of results reported by ORCA Foundry.

The ECLK delays are to all of the PIOs on one side of the device for middle pin input, or two sides of the device for corner pin input. The delay includes both the input buffer delay and the clock routing to the PIO clock input.

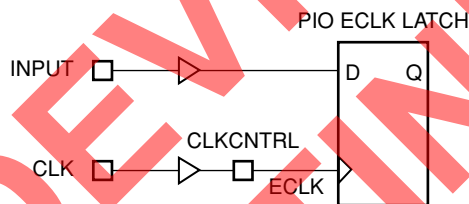

Figure 9. Input to ExpressCLK Setup/Hold Time

5-4847(F).b

Timing Characteristics (continued)

Table 20. OR3Lxxx Input to Fast Clock Setup/Hold Time (Pin-to-Pin)

OR3LxxxB Commercial: VDD = 3.0 V to 3.6 V, VDD2 = 2.38 V to 2.63 V, 0 °C < TA < 70 °C; Industrial: VDD = 3.0 V to 3.6 V, VDD2 = 2.38 V to 2.63 V, -40 °C < TA < +85 °C.

| Description (T _J = 85 °C, VDD = min, VDD2 = min) | Device | -7 | | -8 | | Unit |
|---|---------|------|-----|------|-----|------|
| | | Min | Max | Min | Max | |
| Output Not on Same Side of Device As Input Clock (Fast Clock Delays Using ExpressCLK Inputs) | | | | | | |
| Input to FCLK Setup Time (middle ECLK pin) | OR3L165 | 0.0 | — | 0.0 | — | ns |
| | OR3L225 | 0.0 | — | 0.0 | — | ns |
| Input to FCLK Setup Time (middle ECLK pin, delayed data input) | OR3L165 | 6.39 | — | 5.56 | — | ns |
| | OR3L225 | 6.37 | — | 5.55 | — | ns |
| Input to FCLK Setup Time (corner ECLK pin) | OR3L165 | 0.0 | — | 0.0 | — | ns |
| | OR3L225 | 0.0 | — | 0.0 | — | ns |
| Input to FCLK Setup Time (corner ECLK pin, delayed data input) | OR3L165 | 4.17 | — | 3.76 | — | ns |
| | OR3L225 | 3.97 | — | 3.58 | — | ns |
| Input to FCLK Hold Time (middle ECLK pin) | OR3L165 | 4.93 | — | 4.44 | — | ns |
| | OR3L225 | 5.22 | — | 4.72 | — | ns |

Notes:

The pin-to-pin timing parameters in this table should be used instead of results reported by ORCA Foundry.

The FCLK delays are for a fully routed clock tree that uses the ExpressCLK input into the fast clock network. It includes both the input buffer delay and the clock routing to the PFU CLK input. The delay will be reduced if any of the clock branches are not used.

Timing Characteristics (continued)

Table 20. OR3Lxxx Input to Fast Clock Setup/Hold Time (Pin-to-Pin) (continued)

OR3LxxB Commercial: VDD = 3.0 V to 3.6 V, VDD2 = 2.38 V to 2.63 V, 0 °C < TA < 70 °C; Industrial: VDD = 3.0 V to 3.6 V, VDD2 = 2.38 V to 2.63 V, -40 °C < TA < +85 °C.

| Description (T _J = 85 °C, VDD = min, VDD2 = min) | Device | -7 | | -8 | | Unit |
|--|---------|------|-----|------|-----|------|
| | | Min | Max | Min | Max | |
| Input to FCLK Hold Time (middle ECLK pin, delayed data input) | OR3L165 | 0.0 | — | 0.0 | — | ns |
| | OR3L225 | 0.0 | — | 0.0 | — | ns |
| Input to FCLK Hold Time (corner ECLK pin) | OR3L165 | 7.59 | — | 6.61 | — | ns |
| | OR3L225 | 8.08 | — | 7.06 | — | ns |
| Input to FCLK Hold Time (corner ECLK pin, delayed data input) | OR3L165 | 0.0 | — | 0.0 | — | ns |
| | OR3L225 | 0.0 | — | 0.0 | — | ns |

Notes:

The pin-to-pin timing parameters in this table should be used instead of results reported by ORCA Foundry.

The FCLK delays are for a fully routed clock tree that uses the ExpressCLK input into the fast clock network. It includes both the input buffer delay and the clock routing to the PFU CLK input. The delay will be reduced if any of the clock branches are not used.

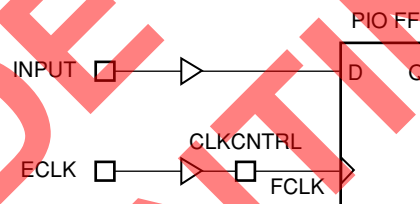

Figure 10. Input to Fast Clock Setup/Hold Time

5-4847(F).a

Timing Characteristics (continued)

Table 21. OR3Lxxx Input to General System Clock (SCLK) Setup/Hold Time (Pin-to-Pin)

OR3Lxxx Commercial: VDD = 3.0 V to 3.6 V, VDD2 = 2.38 V to 2.63 V, 0 °C < TA < 70 °C; Industrial: VDD = 3.0 V to 3.6 V, VDD2 = 2.38 V to 2.63 V, -40 °C < TA < +85 °C.

| Description (T _J = 85 °C, VDD = min, VDD2 = min) | Device | -7 | | -8 | | Unit |
|---|---------|------|-----|------|-----|------|
| | | Min | Max | Min | Max | |
| Input to SCLK Setup Time | OR3L165 | 0.0 | — | 0.0 | — | ns |
| | OR3L225 | 0.0 | — | 0.0 | — | ns |
| Input to SCLK Setup Time (delayed data input) | OR3L165 | 5.69 | — | 5.07 | — | ns |
| | OR3L225 | 5.57 | — | 4.96 | — | ns |
| Input to SCLK Hold Time | OR3L165 | 6.46 | — | 5.67 | — | ns |
| | OR3L225 | 6.96 | — | 6.16 | — | ns |
| Input to SCLK Hold Time (delayed data input) | OR3L165 | 0.0 | — | 0.0 | — | ns |
| | OR3L225 | 0.0 | — | 0.0 | — | ns |
| Additional Hold Time if Non-mid-PIC Used as SCLK Pin (no delay on data input) | OR3L165 | 1.04 | — | 1.03 | — | ns |
| | OR3L225 | 1.43 | — | 1.43 | — | ns |

Notes:

The pin-to-pin timing parameters in this table should be used instead of results reported by ORCA Foundry.

This clock delay is for a fully routed clock tree that uses the clock network. It includes both the input buffer delay and the clock routing to the PIO FF CLK input. The delay will be reduced if any of the clock branches are not used. The given setup (delayed and no delay) and hold (delayed) timing allows the input clock pin to be located in any PIO on any side of the device, but a PIO FF must be used. The hold (no delay) timing assumes the clock pin is located at one of the four middle PICs on any side of the device and that a PIO FF is used. If the clock pin is located elsewhere, then the last parameter in the table must be added to the hold (no delay) timing.

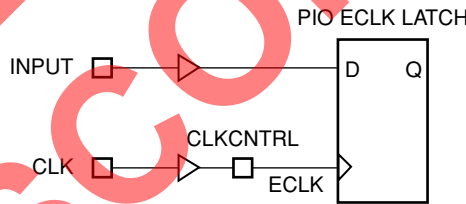

Figure 11. Input to System Clock Setup/Hold Time

5-4847 (F)

Timing Characteristics (continued)

Description

To define speed grades, the *ORCA* Series part number designation (see Ordering Information) uses a single-digit number to designate a speed grade. This number is not related to any single ac parameter. Higher numbers indicate a faster set of timing parameters. The actual speed sorting is based on testing the delay in a path consisting of an input buffer, combinatorial delay through all PLCs in a row, and an output buffer. Other tests are then done to verify other delay parameters, such as routing delays, setup times to FFs, etc.

The most accurate timing characteristics are reported by the timing analyzer in the *ORCA* Foundry Development System. A timing report provided by the development system after layout divides path delays into logic and routing delays. The timing analyzer can also provide logic delays prior to layout. While this allows routing budget estimates, there is wide variance in routing delays associated with different layouts.

The logic timing parameters noted in the Electrical Characteristics section of this data sheet are the same as those in the design tools. In the PFU timing, symbol names are generally a concatenation of the PFU operating mode and the parameter type. The setup, hold, and propagation delay parameters, defined below, are designated in the symbol name by the SET, HLD, and DEL characters, respectively.

The values given for the parameters are the same as those used during production testing and speed binning of the devices. The junction temperature and supply voltage used to characterize the devices are listed in the delay tables. Actual delays at nominal temperature and voltage for best-case processes can be much better than the values given.

It should be noted that the junction temperature used in the tables is generally 85 °C. The junction temperature for the FPGA depends on the power dissipated by the device, the package thermal characteristics (Θ_{JA}), and the ambient temperature, as calculated in the following equation and as discussed further in the Package Thermal Characteristics section:

$$T_{Jmax} = T_{Amax} + (P \cdot \Theta_{JA}) \text{ } ^\circ\text{C}$$

Note: The user must determine this junction temperature to see if the delays from *ORCA* Foundry should be derated based on the following derating tables.

Table 22 and Table 23 provide approximate power supply and junction temperature derating for OR3Lxxx commercial and industrial devices. The delay values in this data sheet and reported by *ORCA* Foundry are shown as 1.00 in the tables. The method for determining the maximum junction temperature is defined in the Package Thermal Characteristics section. Taken cumulatively, the range of parameter values for best-case vs. worst-case processing, supply voltage, and junction temperature can approach three to one.

Timing Characteristics (continued)**Table 22. Derating for Commercial/Industrial OR3Lxxx Devices (I/O Supply VDD)**

| T _J (°C) | Power Supply Voltage | | |
|------------------------|----------------------|-------|-------|
| | 3.0 V | 3.3 V | 3.6 V |
| -40 | 0.82 | 0.72 | 0.66 |
| 0 | 0.91 | 0.80 | 0.72 |
| 25 | 0.98 | 0.85 | 0.77 |
| 85 | 1.00 | 0.99 | 0.90 |
| 100 | 1.23 | 1.07 | 0.94 |
| 125 | 1.34 | 1.15 | 1.01 |

Table 23. Derating for Commercial/Industrial OR3Lxxx Devices (I/O Supply VDD2)

| T _J (°C) | Power Supply Voltage | | |
|------------------------|----------------------|-------|-------|
| | 2.3 V | 2.5 V | 2.6 V |
| -40 | 0.86 | 0.71 | 0.67 |
| 0 | 0.94 | 0.79 | 0.73 |
| 25 | 0.99 | 0.84 | 0.77 |
| 85 | 1.00 | 0.99 | 0.92 |
| 100 | 1.23 | 1.05 | 0.96 |
| 125 | 1.33 | 1.13 | 1.03 |

Note: The derating tables shown above are for a typical critical path that contains 33% logic delay and 66% routing delay. Since the routing delay derates at a higher rate than the logic delay, paths with more than 66% routing delay will derate at a higher rate than shown in the table. The approximate derating values vs. temperature are 0.26% per °C for logic delay and 0.45% per °C for routing delay. The approximate derating values vs. voltage are 0.13% per mV for both logic and routing delays at 25 °C.

In addition to supply voltage, process variation, and operating temperature, circuit and process improvements of the *ORCA* Series FPGAs over time will result in significant improvement of the actual performance over those listed for a speed grade. Even though lower speed grades may still be available, the distribution of yield to timing parameters may be several speed grades higher than that designated on a product brand. Design practices need to consider best-case timing parameters (e.g., delays = 0), as well as worst-case timing.

The routing delays are a function of fan-out and the capacitance associated with the CIPs and metal interconnect in the path. The number of logic elements that can be driven (fan-out) by PFUs is unlimited, although the delay to reach a valid logic level can exceed timing requirements. It is difficult to make accurate routing delay estimates prior to design compilation based on fan-out. This is because the CAE software may delete redundant logic inserted by the designer to reduce fan-out, and/or it may also automatically reduce fan-out by net splitting.

Estimating Power Dissipation

OR3LxxxB

The total operating power dissipated is estimated by adding the standby (IDDSB), internal, and external power dissipated. The internal and external power is the power consumed in the PLCs and PICs, respectively. In general, the standby power is small and may be neglected. The total operating power is as follows:

$$P_T = \Sigma P_{PLC} + \Sigma P_{PIC}$$

The internal operating power is made up of two parts: clock generation and PFU output power. The PFU output power can be estimated based upon the number of PFU outputs switching when driving an average fan-out of two:

$$P_{PFU} = 0.078 \text{ mW/MHz}$$

For each PFU output that switches, 0.136 mW/MHz needs to be multiplied times the frequency (in MHz) that the output switches. Generally, this can be estimated by using one-half the clock rate, multiplied by some activity factor; for example, 20%.

The power dissipated by the clock generation circuitry is based upon four parts: the fixed clock power, the power/clock branch row or column, the clock power dissipated in each PFU that uses this particular clock, and the power from the subset of those PFUs that are configured as synchronous memory. Therefore, the clock power can be calculated for the four parts using the following equations.

OR3L165B Clock Power

$$P = [0.039 \text{ mW/MHz} \\ + (0.046 \text{ mW/MHz/Branch}) (\# \text{ Branches}) \\ + (0.008 \text{ mW/MHz/PFU}) (\# \text{ PFUs}) \\ + (0.002 \text{ mW/MHz/PIO}) (\# \text{ PIOs})]$$

For a quick estimate, the worst-case (typical circuit) OR3L165B clock power = 9.8 mW/MHz

OR3L225B Clock Power

$$P = [0.045 \text{ mW/MHz} \\ + (0.053 \text{ mW/MHz/Branch}) (\# \text{ Branches}) \\ + (0.008 \text{ mW/MHz/PFU}) (\# \text{ PFUs}) \\ + (0.002 \text{ mW/MHz/PIO}) (\# \text{ PIOs})]$$

For a quick estimate, the worst-case (typical circuit) OR3L225B clock power = 13.5 mW/MHz

The power dissipated in a PIC is the sum of the power dissipated in the four PIOs in the PIC. This consists of power dissipated by inputs and ac power dissipated by outputs. The power dissipated in each PIO depends on whether it is configured as an input, output, or input/output. If a PIO is operating as an output, then there is a power dissipation component for P_{IN} , as well as P_{OUT} . This is because the output feeds back to the input.

The power dissipated by an input buffer is ($V_{IH} = V_{DD} - 0.3 \text{ V}$ or higher) estimated as:

$$P_{IN} = 0.09 \text{ mW/MHz}$$

The ac power dissipation from an output or bidirectional is estimated by the following:

$$P_{OUT} = (C_L + 8.8 \text{ pF}) \times V_{DD}^2 \times F \text{ Watts}$$

where the unit for C_L is farads, and the unit for F is Hz.

Pin Information

Table 24. 208-Pin SQFP2 Pinout

| Pin | OR3L165B | Function | Pin | OR3L165B | Function |
|-----|----------|-----------------|-----|----------|------------|
| 1 | Vss | Vss | 43 | PL24D | I/O |
| 2 | Vss | Vss | 44 | PL24B | I/O-A13 |
| 3 | PL1D | I/O | 45 | PL25D | I/O |
| 4 | PL3D | I/O-A0/MPI_BE0 | 46 | PL27A | I/O-A14 |
| 5 | VDD2 | VDD2 | 47 | PL29D | I/O |
| 6 | PL6D | I/O | 48 | PL30D | I/O |
| 7 | PL8D | I/O-A1/MPI_BE1 | 49 | PL30A | I/O-SECKLL |
| 8 | PL9A | I/O-A2 | 50 | PL32A | I/O-A15 |
| 9 | PL10D | I/O | 51 | Vss | Vss |
| 10 | PL10B | I/O | 52 | PCCLK | CCLK |
| 11 | PL10A | I/O-A3 | 53 | Vss | Vss |
| 12 | VDD | VDD | 54 | Vss | Vss |
| 13 | PL11D | I/O | 55 | PB1A | I/O-A16 |
| 14 | PL11A | I/O | 56 | PB3A | I/O |
| 15 | PL12D | I/O | 57 | VDD2 | VDD2 |
| 16 | PL12A | I/O-A4 | 58 | PB4D | I/O |
| 17 | PL13D | I/O-A5 | 59 | PB5D | I/O-A17 |
| 18 | PL13A | I/O | 60 | PB6D | I/O |
| 19 | PL14D | I/O | 61 | PB7D | I/O |
| 20 | PL14A | I/O-A6 | 62 | PB8D | I/O |
| 21 | Vss | Vss | 63 | PB9D | I/O |
| 22 | PECKL | I/O-ECKL | 64 | PB10D | I/O |
| 23 | PL15A | I/O | 65 | VDD | VDD |
| 24 | PL16C | I/O | 66 | PB11A | I/O |
| 25 | PL16A | I/O-A7/MPI_CLK | 67 | PB11D | I/O |
| 26 | VDD | VDD | 68 | PB12A | I/O |
| 27 | PL17D | I/O | 69 | PB12D | I/O |
| 28 | VDD2 | VDD2 | 70 | PB13A | I/O |
| 29 | PL18C | I/O | 71 | PB13D | I/O |
| 30 | PL18A | I/O-A8/MPI_RW | 72 | PB14A | I/O |
| 31 | Vss | Vss | 73 | PB14D | I/O |
| 32 | PL19D | I/O-A9/MPI_ACK | 74 | Vss | Vss |
| 33 | PL19A | I/O | 75 | PB15A | I/O |
| 34 | PL20D | I/O | 76 | PB15D | I/O |
| 35 | PL20A | I/O-A10/MPI_BI | 77 | PB16B | I/O |
| 36 | PL21D | I/O | 78 | PB16D | I/O |
| 37 | PL21A | I/O | 79 | Vss | Vss |
| 38 | PL22D | I/O | 80 | PECKB | I/O-ECKB |
| 39 | PL22A | I/O-A11/MPI_IRQ | 81 | PB17D | I/O |
| 40 | VDD | VDD | 82 | PB18B | I/O |
| 41 | PL23D | I/O-A12 | 83 | PB18D | I/O |
| 42 | PL23B | I/O | 84 | Vss | Vss |

Pin Information (continued)

Table 24. 208-Pin SQFP2 Pinout (continued)

| Pin | OR3L165B | Function | Pin | OR3L165B | Function |
|-----|----------|----------|-----|----------|----------------------|
| 85 | VDD2 | VDD2 | 127 | PR18D | I/O |
| 86 | PB19D | I/O | 128 | PR17B | I/O |
| 87 | PB20A | I/O | 129 | PR17D | I/O |
| 88 | PB20D | I/O | 130 | VDD | VDD |
| 89 | PB21A | I/O-HDC | 131 | PECKR | I/O-ECKR |
| 90 | PB21D | I/O | 132 | PR16D | I/O |
| 91 | PB22A | I/O | 133 | PR15B | I/O |
| 92 | PB22D | I/O | 134 | PR15D | I/O |
| 93 | VDD | VDD | 135 | VSS | VSS |
| 94 | PB23A | I/O-LDC | 136 | VDD2 | VDD2 |
| 95 | PB24D | I/O | 137 | PR14D | I/O |
| 96 | PB25A | I/O | 138 | PR13A | I/O |
| 97 | PB26D | I/O | 139 | PR13D | I/O |
| 98 | PB27A | I/O-INIT | 140 | PR12A | I/O-CS1 |
| 99 | PB28A | I/O | 141 | PR12D | I/O |
| 100 | PB29A | I/O | 142 | PR11A | I/O |
| 101 | PB30D | I/O | 143 | PR11D | I/O |
| 102 | PB32D | I/O | 144 | VDD | VDD |
| 103 | VSS | VSS | 145 | PR10A | I/O-CS0 |
| 104 | PDONE | DONE | 146 | PR10B | I/O |
| 105 | VSS | VSS | 147 | PR9B | I/O |
| 106 | PRESETN | RESET | 148 | PR9D | I/O |
| 107 | PPRGMN | PRGM | 149 | PR8A | I/O-RD/MPI_STRB |
| 108 | PR32A | I/O-M0 | 150 | PR6A | I/O |
| 109 | PR30A | I/O | 151 | PR5A | I/O |
| 110 | PR29A | I/O | 152 | PR4A | I/O-WR |
| 111 | PR28A | I/O | 153 | PR3A | I/O |
| 112 | PR25D | I/O-M1 | 154 | PR2A | I/O |
| 113 | PR24A | I/O | 155 | VSS | VSS |
| 114 | VDD2 | VDD2 | 156 | PRD_CFGN | RD_CFG |
| 115 | PR23A | I/O | 157 | VSS | VSS |
| 116 | VDD | VDD | 158 | VSS | VSS |
| 117 | PR22A | I/O-M2 | 159 | PT32D | I/O-SECKUR |
| 118 | PR22D | I/O | 160 | PT30A | I/O-RDY/RCLK/MPI_ALE |
| 119 | PR21A | I/O | 161 | PT28D | I/O |
| 120 | PR21D | I/O | 162 | PT28A | I/O |
| 121 | PR20A | I/O-M3 | 163 | PT27D | I/O-D7 |
| 122 | PR20D | I/O | 164 | VDD2 | VDD2 |
| 123 | PR19A | I/O | 165 | PT25D | I/O |
| 124 | PR19D | I/O | 166 | PT24D | I/O |
| 125 | VSS | VSS | 167 | PT23D | I/O-D6 |
| 126 | PR18A | I/O | 168 | VDD | VDD |

Pin Information (continued)

Table 24. 208-Pin SQFP2 Pinout (continued)

| Pin | OR3L165B | Function | Pin | OR3L165B | Function |
|-----|----------|----------|-----|----------|-------------|
| 169 | PT22D | I/O | 189 | PT14A | I/O |
| 170 | PT22A | I/O | 190 | PT13D | I/O |
| 171 | PT21D | I/O | 191 | PT13A | I/O-D0/DIN |
| 172 | PT21A | I/O-D5 | 192 | PT12D | I/O |
| 173 | PT20D | I/O | 193 | PT12A | I/O |
| 174 | PT20A | I/O | 194 | PT11D | I/O |
| 175 | PT19D | I/O | 195 | PT11A | I/O-DOUT |
| 176 | PT19A | I/O-D4 | 196 | VDD | VDD |
| 177 | Vss | Vss | 197 | PT10D | I/O |
| 178 | PECKT | I/O-ECKT | 198 | PT9A | I/O |
| 179 | PT18B | I/O | 199 | PT8A | I/O |
| 180 | PT17D | I/O | 200 | PT7A | I/O-TDI |
| 181 | PT17A | I/O-D3 | 201 | PT6A | I/O |
| 182 | Vss | Vss | 202 | PT5A | I/O-TMS |
| 183 | PT16D | I/O | 203 | PT4A | I/O |
| 184 | PT16C | I/O | 204 | PT3A | I/O |
| 185 | VDD2 | VDD2 | 205 | PT2D | I/O |
| 186 | PT15A | I/O-D2 | 206 | PT1A | I/O-TCK |
| 187 | Vss | Vss | 207 | Vss | Vss |
| 188 | PT14D | I/O-D1 | 208 | PRD_DATA | RD_DATA/TDO |

Pin Information (continued)

Table 25. 240-Pin SQFP2 Pinout

| Pin | OR3L165B | Function | Pin | OR3L165B | Function |
|-----|----------|----------------|-----|----------|-----------------|
| 1 | Vss | Vss | 42 | PL22D | I/O |
| 2 | VDD | VDD | 43 | PL22A | I/O-A11/MPI_IRQ |
| 3 | PL1D | I/O | 44 | VDD | VDD |
| 4 | PL1A | I/O | 45 | PL23D | I/O-A12 |
| 5 | PL2D | I/O | 46 | PL23B | I/O |
| 6 | PL3D | I/O-A0/MPI_BE0 | 47 | PL24D | I/O |
| 7 | Vss | Vss | 48 | PL24B | I/O-A13 |
| 8 | VDD2 | VDD2 | 49 | PL24A | I/O |
| 9 | PL6D | I/O | 50 | PL25D | I/O |
| 10 | PL7D | I/O | 51 | PL26D | I/O |
| 11 | PL8D | I/O-A1/MPI_BE1 | 52 | PL27A | I/O-A14 |
| 12 | PL9A | I/O-A2 | 53 | Vss | Vss |
| 13 | PL10D | I/O | 54 | PL29D | I/O |
| 14 | PL10B | I/O | 55 | PL30D | I/O |
| 15 | PL10A | I/O-A3 | 56 | PL30A | I/O-SECKLL |
| 16 | VDD | VDD | 57 | PL32A | I/O-A15 |
| 17 | PL11D | I/O | 58 | Vss | Vss |
| 18 | PL11A | I/O | 59 | PCCLK | CCLK |
| 19 | PL12D | I/O | 60 | VDD | VDD |
| 20 | PL12A | I/O-A4 | 61 | Vss | Vss |
| 21 | PL13D | I/O-A5 | 62 | Vss | Vss |
| 22 | PL13A | I/O | 63 | PB1A | I/O-A16 |
| 23 | PL14D | I/O | 64 | PB3A | I/O |
| 24 | PL14A | I/O-A6 | 65 | VDD2 | VDD2 |
| 25 | Vss | Vss | 66 | PB4D | I/O |
| 26 | PECKL | I/O-ECKL | 67 | Vss | Vss |
| 27 | PL15A | I/O | 68 | PB5D | I/O-A17 |
| 28 | PL16C | I/O | 69 | PB6D | I/O |
| 29 | PL16A | I/O-A7/MPI_CLK | 70 | PB7A | I/O |
| 30 | VDD | VDD | 71 | PB7D | I/O |
| 31 | PL17D | I/O | 72 | PB8D | I/O |
| 32 | VDD2 | VDD2 | 73 | PB9A | I/O |
| 33 | PL18C | I/O | 74 | PB9D | I/O |
| 34 | PL18A | I/O-A8/MPI_RW | 75 | PB10D | I/O |
| 35 | Vss | Vss | 76 | VDD | VDD |
| 36 | PL19D | I/O-A9/MPI_ACK | 77 | PB11A | I/O |
| 37 | PL19A | I/O | 78 | PB11D | I/O |
| 38 | PL20D | I/O | 79 | PB12A | I/O |
| 39 | PL20A | I/O-A10/MPI_BI | 80 | PB12D | I/O |
| 40 | PL21D | I/O | 81 | PB13A | I/O |
| 41 | PL21A | I/O | 82 | PB13D | I/O |

Pin Information (continued)

Table 25. 240-Pin SQFP2 Pinout (continued)

| Pin | OR3L165B | Function | Pin | OR3L165B | Function |
|-----|----------|----------|-----|----------|----------|
| 83 | PB14A | I/O | 125 | PR31D | I/O |
| 84 | PB14D | I/O | 126 | PR30A | I/O |
| 85 | Vss | Vss | 127 | PR29A | I/O |
| 86 | PB15A | I/O | 128 | Vss | Vss |
| 87 | PB15D | I/O | 129 | PR28A | I/O |
| 88 | PB16B | I/O | 130 | PR27A | I/O |
| 89 | PB16D | I/O | 131 | PR26A | I/O |
| 90 | Vss | Vss | 132 | PR26D | I/O |
| 91 | PECKB | I/O-ECKB | 133 | PR25D | I/O-M1 |
| 92 | PB17D | I/O | 134 | PR24A | I/O |
| 93 | PB18B | I/O | 135 | VDD2 | VDD2 |
| 94 | PB18D | I/O | 136 | PR23A | I/O |
| 95 | Vss | Vss | 137 | VDD | VDD |
| 96 | VDD2 | VDD2 | 138 | PR22A | I/O-M2 |
| 97 | PB19D | I/O | 139 | PR22D | I/O |
| 98 | PB20A | I/O | 140 | PR21A | I/O |
| 99 | PB20D | I/O | 141 | PR21D | I/O |
| 100 | PB21A | I/O-HDC | 142 | PR20A | I/O-M3 |
| 101 | PB21D | I/O | 143 | PR20D | I/O |
| 102 | PB22A | I/O | 144 | PR19A | I/O |
| 103 | PB22D | I/O | 145 | PR19D | I/O |
| 104 | VDD | VDD | 146 | Vss | Vss |
| 105 | PB23A | I/O-LDC | 147 | PR18A | I/O |
| 106 | PB24D | I/O | 148 | PR18D | I/O |
| 107 | PB25A | I/O | 149 | PR17B | I/O |
| 108 | PB26D | I/O | 150 | PR17D | I/O |
| 109 | PB27A | I/O-INIT | 151 | VDD | VDD |
| 110 | PB27D | I/O | 152 | PECKR | I/O-ECKR |
| 111 | PB28A | I/O | 153 | PR16D | I/O |
| 112 | PB28D | I/O | 154 | PR15B | I/O |
| 113 | Vss | Vss | 155 | PR15D | I/O |
| 114 | PB29A | I/O | 156 | Vss | Vss |
| 115 | PB30A | I/O | 157 | VDD2 | VDD2 |
| 116 | PB30D | I/O | 158 | PR14D | I/O |
| 117 | PB32D | I/O | 159 | PR13A | I/O |
| 118 | Vss | Vss | 160 | PR13D | I/O |
| 119 | PDONE | DONE | 161 | PR12A | I/O-CS1 |
| 120 | VDD | VDD | 162 | PR12D | I/O |
| 121 | Vss | Vss | 163 | PR11A | I/O |
| 122 | PRESETN | RESET | 164 | PR11D | I/O |
| 123 | PPRGMN | PRGM | 165 | VDD | VDD |
| 124 | PR32A | I/O-M0 | 166 | PR10A | I/O-CS0 |

Pin Information (continued)

Table 25. 240-Pin SQFP2 Pinout (continued)

| Pin | OR3L165B | Function | Pin | OR3L165B | Function |
|-----|----------|----------------------|-----|----------|-------------|
| 167 | PR10B | I/O | 204 | PT19D | I/O |
| 168 | PR9B | I/O | 205 | PT19A | I/O-D4 |
| 169 | PR9D | I/O | 206 | Vss | Vss |
| 170 | PR8A | I/O-RD/MPI_STRB | 207 | PECKT | I/O-ECKT |
| 171 | PR7A | I/O | 208 | PT18B | I/O |
| 172 | PR6A | I/O | 209 | PT17D | I/O |
| 173 | PR5A | I/O | 210 | PT17A | I/O-D3 |
| 174 | Vss | Vss | 211 | Vss | Vss |
| 175 | PR4A | I/O-WR | 212 | PT16D | I/O |
| 176 | PR3A | I/O | 213 | PT16C | I/O |
| 177 | PR2A | I/O | 214 | VDD2 | VDD2 |
| 178 | PR1D | I/O | 215 | PT15A | I/O-D2 |
| 179 | Vss | Vss | 216 | Vss | Vss |
| 180 | PRD_CFGN | RD_CFG | 217 | PT14D | I/O-D1 |
| 181 | Vss | Vss | 218 | PT14A | I/O |
| 182 | VDD | VDD | 219 | PT13D | I/O |
| 183 | Vss | Vss | 220 | PT13A | I/O-D0/DIN |
| 184 | PT32D | I/O-SECKUR | 221 | PT12D | I/O |
| 185 | PT31A | I/O | 222 | PT12A | I/O |
| 186 | PT30D | I/O | 223 | PT11D | I/O |
| 187 | PT30A | I/O-RDY/RCLK/MPI_ALE | 224 | PT11A | I/O-DOUT |
| 188 | Vss | Vss | 225 | VDD | VDD |
| 189 | PT28D | I/O | 226 | PT10D | I/O |
| 190 | PT28C | I/O | 227 | PT9A | I/O |
| 191 | PT28A | I/O | 228 | PT8A | I/O |
| 192 | PT27D | I/O-D7 | 229 | PT7A | I/O-TDI |
| 193 | VDD2 | VDD2 | 230 | PT6D | I/O |
| 194 | PT25D | I/O | 231 | PT6A | I/O |
| 195 | PT24D | I/O | 232 | PT5D | I/O |
| 196 | PT23D | I/O-D6 | 233 | PT5A | I/O-TMS |
| 197 | VDD | VDD | 234 | Vss | Vss |
| 198 | PT22D | I/O | 235 | PT4A | I/O |
| 199 | PT22A | I/O | 236 | PT3A | I/O |
| 200 | PT21D | I/O | 237 | PT2D | I/O |
| 201 | PT21A | I/O-D5 | 238 | PT1A | I/O-TCK |
| 202 | PT20D | I/O | 239 | Vss | Vss |
| 203 | PT20A | I/O | 240 | PRD_DATA | RD_DATA/TDO |

Pin Information (continued)

Table 26. 352-Pin PBGA Pinout

| Pin | OR3L165B | Function | Pin | OR3L165B | Function |
|-----|----------|----------------|-----|----------|-----------------|
| B1 | PL1D | I/O | P2 | PL17D | I/O |
| C2 | PL1A | I/O | P4 | VDD2 | VDD2 |
| C1 | PL2D | I/O | P1 | PL18C | I/O |
| D2 | PL2A | I/O | N3 | PL18A | I/O-A8/MPI_RW |
| D3 | PL3D | I/O-A0/MPI_BE0 | R2 | PL19D | I/O-A9/MPI_ACK |
| D1 | PL3A | I/O | P3 | PL19A | I/O |
| E2 | PL4D | I/O | R1 | PL20D | I/O |
| E4 | PL4B | I/O | T2 | PL20A | I/O-A10/MPI_BI |
| E3 | PL4A | I/O | R3 | PL21D | I/O |
| E1 | VDD2 | VDD2 | T1 | PL21A | I/O |
| F2 | PL5C | I/O | R4 | PL22D | I/O |
| G4 | PL5B | I/O | U2 | PL22A | I/O-A11/MPI_IRQ |
| F3 | PL6D | I/O | T3 | PL23D | I/O-A12 |
| F1 | PL7D | I/O | U1 | PL23C | I/O |
| G2 | PL7C | I/O | U4 | PL23B | I/O |
| G1 | PL7B | I/O | V2 | PL23A | I/O |
| G3 | PL8D | I/O-A1/MPI_BE1 | U3 | PL24D | I/O |
| H2 | PL9D | I/O | V1 | PL24C | I/O |
| J4 | PL9C | I/O | W2 | PL24B | I/O-A13 |
| H1 | PL9B | I/O | W1 | PL24A | I/O |
| H3 | PL9A | I/O-A2 | V3 | PL25D | I/O |
| J2 | PL10D | I/O | Y2 | PL25C | I/O |
| J1 | PL10C | I/O | W4 | PL26D | I/O |
| K2 | PL10B | I/O | Y1 | PL27D | I/O |
| J3 | PL10A | I/O-A3 | W3 | PL27A | I/O-A14 |
| K1 | PL11D | I/O | AA2 | PL28C | I/O |
| K4 | PL11A | I/O | Y4 | PL28B | I/O |
| L2 | PL12D | I/O | AA1 | PL28A | I/O |
| K3 | PL12A | I/O-A4 | Y3 | VDD2 | VDD2 |
| L1 | PL13D | I/O-A5 | AB2 | PL29C | I/O |
| M2 | PL13A | I/O | AB1 | PL29A | I/O |
| M1 | PL14D | I/O | AA3 | PL30D | I/O |
| L3 | PL14A | I/O-A6 | AC2 | PL30C | I/O |
| N2 | PECKL | I/O-ECKL | AB4 | PL30A | I/O-SECKLL |
| M4 | PL15A | I/O | AC1 | PL31A | I/O |
| N1 | PL16C | I/O | AB3 | PL32C | I/O |
| M3 | PL16A | I/O-A7/MPI_CLK | AD2 | PL32B | I/O |

Pin Information (continued)

Table 26. 352-Pin PBGA Pinout (continued)

| Pin | OR3L165B | Function | Pin | OR3L165B | Function |
|------|----------|----------|------|----------|----------|
| AC3 | PL32A | I/O-A15 | AE14 | PECKB | I/O-ECKB |
| AD1 | PCCLK | CCLK | AC14 | PB17D | I/O |
| AF2 | PB1A | I/O-A16 | AF14 | PB18B | I/O |
| AE3 | PB1B | I/O | AD13 | PB18D | I/O |
| AF3 | PB2A | I/O | AE15 | VDD2 | VDD2 |
| AE4 | PB2D | I/O | AD14 | PB19D | I/O |
| AD4 | PB3A | I/O | AF15 | PB20A | I/O |
| AF4 | VDD2 | VDD2 | AE16 | PB20D | I/O |
| AE5 | PB4A | I/O | AD15 | PB21A | I/O-HDC |
| AC5 | PB4C | I/O | AF16 | PB21D | I/O |
| AD5 | PB4D | I/O | AC15 | PB22A | I/O |
| AF5 | PB5A | I/O | AE17 | PB22D | I/O |
| AE6 | PB5B | I/O | AD16 | PB23A | I/O-LDC |
| AC7 | PB5C | I/O | AF17 | PB23D | I/O |
| AD6 | PB5D | I/O-A17 | AC17 | PB24A | I/O |
| AF6 | PB6A | I/O | AE18 | PB24D | I/O |
| AE7 | PB6B | I/O | AD17 | PB25A | I/O |
| AF7 | PB6C | I/O | AF18 | PB26A | I/O |
| AD7 | PB6D | I/O | AE19 | PB26C | I/O |
| AE8 | PB7A | I/O | AF19 | PB26D | I/O |
| AC9 | PB7D | I/O | AD18 | PB27A | I/O-INIT |
| AF8 | PB8A | I/O | AE20 | PB27B | I/O |
| AD8 | PB8D | I/O | AC19 | PB27C | I/O |
| AE9 | PB9A | I/O | AF20 | PB27D | I/O |
| AF9 | PB9D | I/O | AD19 | VDD2 | VDD2 |
| AE10 | PB10A | I/O | AE21 | PB28B | I/O |
| AD9 | PB10D | I/O | AC20 | PB28C | I/O |
| AF10 | PB11A | I/O | AF21 | PB28D | I/O |
| AC10 | PB11D | I/O | AD20 | PB29A | I/O |
| AE11 | PB12A | I/O | AE22 | PB29B | I/O |
| AD10 | PB12D | I/O | AF22 | PB29D | I/O |
| AF11 | PB13A | I/O | AD21 | PB30A | I/O |
| AE12 | PB13D | I/O | AE23 | PB30B | I/O |
| AF12 | PB14A | I/O | AC22 | PB30D | I/O |
| AD11 | PB14D | I/O | AF23 | PB31A | I/O |
| AE13 | PB15A | I/O | AD22 | PB31D | I/O |
| AC12 | PB15D | I/O | AE24 | PB32C | I/O |
| AF13 | PB16B | I/O | AD23 | PB32D | I/O |
| AD12 | PB16D | I/O | AF24 | PDONE | DONE |

Pin Information (continued)

Table 26. 352-Pin PBGA Pinout (continued)

| Pin | OR3L165B | Function | Pin | OR3L165B | Function |
|------|----------|----------|-----|----------|-----------------|
| AE26 | PRESETN | RESET | N26 | PR16D | I/O |
| AD25 | PPRGMN | PRGM | P24 | PR15B | I/O |
| AD26 | PR32A | I/O-M0 | M25 | PR15D | I/O |
| AC25 | PR31A | I/O | N24 | VDD2 | VDD2 |
| AC24 | PR31D | I/O | M26 | PR14D | I/O |
| AC26 | PR30A | I/O | L25 | PR13A | I/O |
| AB25 | PR30D | I/O | M24 | PR13D | I/O |
| AB23 | PR29A | I/O | L26 | PR12A | I/O-CS1 |
| AB24 | PR29B | I/O | M23 | PR12D | I/O |
| AB26 | PR29D | I/O | K25 | PR11A | I/O |
| AA25 | PR28A | I/O | L24 | PR11D | I/O |
| Y23 | PR28B | I/O | K26 | PR10A | I/O-CS0 |
| AA24 | PR28C | I/O | K23 | PR10B | I/O |
| AA26 | PR27A | I/O | J25 | PR10C | I/O |
| Y25 | PR26A | I/O | K24 | PR10D | I/O |
| Y26 | PR26B | I/O | J26 | PR9A | I/O |
| Y24 | PR26D | I/O | H25 | PR9B | I/O |
| W25 | PR25D | I/O-M1 | H26 | PR9C | I/O |
| V23 | PR24A | I/O | J24 | PR9D | I/O |
| W26 | PR24B | I/O | G25 | PR8A | I/O-RD/MPI_STRB |
| W24 | PR24C | I/O | H23 | PR7A | I/O |
| V25 | VDD2 | VDD2 | G26 | PR7C | I/O |
| V26 | PR23A | I/O | H24 | PR6A | I/O |
| U25 | PR23B | I/O | F25 | VDD2 | VDD2 |
| V24 | PR23C | I/O | G23 | PR5B | I/O |
| U26 | PR23D | I/O | F26 | PR5C | I/O |
| U23 | PR22A | I/O-M2 | G24 | PR5D | I/O |
| T25 | PR22D | I/O | E25 | PR4A | I/O-WR |
| U24 | PR21A | I/O | E26 | PR4B | I/O |
| T26 | PR21D | I/O | F24 | PR4D | I/O |
| R25 | PR20A | I/O-M3 | D25 | PR3A | I/O |
| R26 | PR20D | I/O | E23 | PR3D | I/O |
| T24 | PR19A | I/O | D26 | PR2A | I/O |
| P25 | PR19D | I/O | E24 | PR2D | I/O |
| R23 | PR18A | I/O | C25 | PR1A | I/O |
| P26 | PR18D | I/O | D24 | PR1D | I/O |
| R24 | PR17B | I/O | C26 | PRD_CFGN | RD_CFG |
| N25 | PR17D | I/O | A25 | PT32D | I/O-SECKUR |
| N23 | PECKR | I/O-ECKR | B24 | PT32A | I/O |

Pin Information (continued)

Table 26. 352-Pin PBGA Pinout (continued)

| Pin | OR3L165B | Function | Pin | OR3L165B | Function |
|-----|----------|----------------------|------|----------|-------------|
| A24 | PT31B | I/O | B12 | PT14D | I/O-D1 |
| B23 | PT31A | I/O | C13 | PT14A | I/O |
| C23 | PT30D | I/O | A12 | PT13D | I/O |
| A23 | PT30A | I/O-RDY/RCLK/MPI_ALE | B11 | PT13A | I/O-D0/DIN |
| B22 | PT29D | I/O | C12 | PT12D | I/O |
| D22 | PT29C | I/O | A11 | PT12A | I/O |
| C22 | PT29A | I/O | D12 | PT11D | I/O |
| A22 | PT28D | I/O | B10 | PT11A | I/O-DOUT |
| B21 | PT28C | I/O | C11 | PT10D | I/O |
| D20 | PT28B | I/O | A10 | PT10A | I/O |
| C21 | PT28A | I/O | D10 | PT9D | I/O |
| A21 | PT27D | I/O-D7 | B9 | PT9A | I/O |
| B20 | PT27C | I/O | C10 | PT8D | I/O |
| A20 | PT27B | I/O | A9 | PT8A | I/O |
| C20 | PT27A | I/O | B8 | PT7D | I/O |
| B19 | VDD2 | VDD2 | A8 | PT7A | I/O-TDI |
| D18 | PT26C | I/O | C9 | PT6D | I/O |
| A19 | PT26B | I/O | B7 | PT6C | I/O |
| C19 | PT25D | I/O | D8 | PT6B | I/O |
| B18 | PT24D | I/O | A7 | VDD2 | VDD2 |
| A18 | PT24A | I/O | C8 | PT5D | I/O |
| B17 | PT23D | I/O-D6 | B6 | PT5C | I/O |
| C18 | PT23A | I/O | D7 | PT5B | I/O |
| A17 | PT22D | I/O | A6 | PT5A | I/O-TMS |
| D17 | PT22A | I/O | C7 | PT4D | I/O |
| B16 | PT21D | I/O | B5 | PT4A | I/O |
| C17 | PT21A | I/O-D5 | A5 | PT3D | I/O |
| A16 | PT20D | I/O | C6 | PT3C | I/O |
| B15 | PT20A | I/O | B4 | PT3B | I/O |
| A15 | PT19D | I/O | D5 | PT3A | I/O |
| C16 | PT19A | I/O-D4 | A4 | PT2D | I/O |
| B14 | PECKT | I/O-ECKT | C5 | PT2A | I/O |
| D15 | PT18B | I/O | B3 | PT1D | I/O |
| A14 | PT17D | I/O | C4 | PT1A | I/O-TCK |
| C15 | PT17A | I/O-D3 | A3 | PRD_DATA | RD_DATA/TDO |
| B13 | PT16D | I/O | A1 | Vss | Vss |
| D13 | PT16C | I/O | A2 | Vss | Vss |
| A13 | VDD2 | VDD2 | A26 | Vss | Vss |
| C14 | PT15A | I/O-D2 | AC13 | Vss | Vss |

Pin Information (continued)

Table 26. 352-Pin PBGA Pinout (continued)

| Pin | OR3L165B | Function | Pin | OR3L165B | Function |
|------|----------|----------|------|----------|----------|
| AC18 | Vss | Vss | N11 | Vss | Vss |
| AC23 | Vss | Vss | N12 | Vss | Vss |
| AC4 | Vss | Vss | N13 | Vss | Vss |
| AC8 | Vss | Vss | N14 | Vss | Vss |
| AD24 | Vss | Vss | N15 | Vss | Vss |
| AD3 | Vss | Vss | N16 | Vss | Vss |
| AE1 | Vss | Vss | P11 | Vss | Vss |
| AE2 | Vss | Vss | P12 | Vss | Vss |
| AE25 | Vss | Vss | P13 | Vss | Vss |
| AF1 | Vss | Vss | P14 | Vss | Vss |
| AF25 | Vss | Vss | P15 | Vss | Vss |
| AF26 | Vss | Vss | P16 | Vss | Vss |
| B2 | Vss | Vss | R11 | Vss | Vss |
| B25 | Vss | Vss | R12 | Vss | Vss |
| B26 | Vss | Vss | R13 | Vss | Vss |
| C24 | Vss | Vss | R14 | Vss | Vss |
| C3 | Vss | Vss | R15 | Vss | Vss |
| D14 | Vss | Vss | R16 | Vss | Vss |
| D19 | Vss | Vss | T11 | Vss | Vss |
| D23 | Vss | Vss | T12 | Vss | Vss |
| D4 | Vss | Vss | T13 | Vss | Vss |
| D9 | Vss | Vss | T14 | Vss | Vss |
| H4 | Vss | Vss | T15 | Vss | Vss |
| J23 | Vss | Vss | T16 | Vss | Vss |
| N4 | Vss | Vss | AA23 | VDD | VDD |
| P23 | Vss | Vss | AA4 | VDD | VDD |
| V4 | Vss | Vss | AC11 | VDD | VDD |
| W23 | Vss | Vss | AC16 | VDD | VDD |
| L11 | Vss | Vss | AC21 | VDD | VDD |
| L12 | Vss | Vss | AC6 | VDD | VDD |
| L13 | Vss | Vss | D11 | VDD | VDD |
| L14 | Vss | Vss | D16 | VDD | VDD |
| L15 | Vss | Vss | D21 | VDD | VDD |
| L16 | Vss | Vss | D6 | VDD | VDD |
| M11 | Vss | Vss | F23 | VDD | VDD |
| M12 | Vss | Vss | F4 | VDD | VDD |
| M13 | Vss | Vss | L23 | VDD | VDD |
| M14 | Vss | Vss | L4 | VDD | VDD |
| M15 | Vss | Vss | T23 | VDD | VDD |
| M16 | Vss | Vss | T4 | VDD | VDD |

Pin Information (continued)

Table 27. 432-Pin EPGA Pinout

| Pin | OR3L165B | OR3L225B | Function |
|-----|----------|----------|-----------------|
| E4 | PRD_CFGN | PRD_CFGN | RD_CFG |
| D3 | PR1D | PR1D | I/O |
| D2 | PR1A | PR1A | I/O |
| D1 | PR2D | PR2D | I/O |
| F4 | PR2A | PR2A | I/O |
| E3 | PR3D | PR3D | I/O |
| E2 | PR3C | PR3C | I/O |
| E1 | PR3B | PR3B | I/O |
| F3 | PR3A | PR3A | I/O |
| F2 | PR4D | PR4D | I/O |
| F1 | PR4C | PR4C | I/O |
| H4 | PR4B | PR4B | I/O |
| G3 | PR4A | PR4A | I/O-WR |
| G2 | PR5D | PR5D | I/O |
| G1 | PR5C | PR5C | I/O |
| J4 | PR5B | PR5B | I/O |
| H3 | VDD2 | VDD2 | VDD2 |
| H2 | PR6A | PR6A | I/O |
| J3 | PR7C | PR7C | I/O |
| K4 | PR7A | PR7A | I/O |
| J2 | PR8A | PR8A | I/O-RD/MPI_STRB |
| J1 | PR9D | PR9D | I/O |
| K3 | PR9C | PR9A | I/O |
| K2 | PR9B | PR10D | I/O |
| K1 | PR9A | PR10C | I/O |
| L3 | PR10D | PR10A | I/O |
| M4 | PR10C | PR11D | I/O |
| L2 | PR10B | PR11C | I/O |
| L1 | PR10A | PR11A | I/O-CS0 |
| M3 | PR11D | PR12D | I/O |
| N4 | PR11A | PR12A | I/O |
| M2 | PR12D | PR13D | I/O |
| N3 | PR12A | PR13A | I/O-CS1 |
| N2 | PR13D | PR14D | I/O |
| P4 | PR13C | PR14A | I/O |
| N1 | PR13A | PR15A | I/O |
| P3 | PR14D | PR16D | I/O |
| P2 | PR14C | PR16A | I/O |
| P1 | VDD2 | VDD2 | VDD2 |
| R3 | PR15D | PR18D | I/O |
| R2 | PR15B | PR18B | I/O |

Pin Information (continued)

Table 27. 432-Pin EPGA Pinout (continued)

| Pin | OR3L165B | OR3L225B | Function |
|-----|----------|----------|----------|
| R1 | PR16D | PR19D | I/O |
| T2 | PECKR | PECKR | I/O-ECKR |
| T4 | PR17D | PR20D | I/O |
| T3 | PR17B | PR20B | I/O |
| U1 | PR18D | PR21D | I/O |
| U2 | PR18A | PR21A | I/O |
| U3 | PR19D | PR22D | I/O |
| V1 | PR19B | PR23D | I/O |
| V2 | PR19A | PR23A | I/O |
| V3 | PR20D | PR24D | I/O |
| W1 | PR20A | PR25A | I/O-M3 |
| V4 | PR21D | PR26D | I/O |
| W2 | PR21B | PR26B | I/O |
| W3 | PR21A | PR26A | I/O |
| Y2 | PR22D | PR27D | I/O |
| W4 | PR22A | PR27A | I/O-M2 |
| Y3 | PR23D | PR28D | I/O |
| AA1 | PR23C | PR28C | I/O |
| AA2 | PR23B | PR28B | I/O |
| Y4 | PR23A | PR28A | I/O |
| AA3 | VDD2 | VDD2 | VDD2 |
| AB1 | PR24C | PR29A | I/O |
| AB2 | PR24B | PR30D | I/O |
| AB3 | PR24A | PR30A | I/O |
| AC1 | PR25D | PR31D | I/O-M1 |
| AC2 | PR26D | PR32D | I/O |
| AB4 | PR26B | PR32B | I/O |
| AC3 | PR26A | PR32A | I/O |
| AD2 | PR27A | PR33A | I/O |
| AD3 | PR28C | PR34C | I/O |
| AC4 | PR28B | PR34B | I/O |
| AE1 | PR28A | PR34A | I/O |
| AE2 | PR29D | PR35D | I/O |
| AE3 | PR29C | PR35C | I/O |
| AD4 | PR29B | PR35B | I/O |
| AF1 | PR29A | PR35A | I/O |
| AF2 | PR30D | PR36D | I/O |
| AF3 | PR30C | PR36C | I/O |
| AG1 | PR30B | PR36B | I/O |
| AG2 | VDD2 | VDD2 | VDD2 |
| AG3 | PR31D | PR37D | I/O |

Pin Information (continued)

Table 27. 432-Pin EPGA Pinout (continued)

| Pin | OR3L165B | OR3L225B | Function |
|------|----------|----------|----------|
| AF4 | PR31A | PR37A | I/O |
| AH1 | PR32B | PR38B | I/O |
| AH2 | PR32A | PR38A | I/O-M0 |
| AH3 | PPRGMN | PPRGMN | PRGM |
| AG4 | PRESETN | PRESETN | RESET |
| AH5 | PDONE | PDONE | DONE |
| AJ4 | PB32D | PB38D | I/O |
| AK4 | PB32C | PB38C | I/O |
| AL4 | PB31D | PB37D | I/O |
| AH6 | PB31A | PB37A | I/O |
| AJ5 | PB30D | PB36D | I/O |
| AK5 | PB30C | PB36C | I/O |
| AL5 | PB30B | PB36B | I/O |
| AJ6 | PB30A | PB36A | I/O |
| AK6 | PB29D | PB35D | I/O |
| AL6 | PB29C | PB35C | I/O |
| AH8 | PB29B | PB35B | I/O |
| AJ7 | PB29A | PB35A | I/O |
| AK7 | PB28D | PB34D | I/O |
| AL7 | PB28C | PB34C | I/O |
| AH9 | PB28B | PB34B | I/O |
| AJ8 | VDD2 | VDD2 | VDD2 |
| AK8 | PB27D | PB33D | I/O |
| AJ9 | PB27C | PB33C | I/O |
| AH10 | PB27B | PB33B | I/O |
| AK9 | PB27A | PB33A | I/O-INIT |
| AL9 | PB26D | PB32D | I/O |
| AJ10 | PB26C | PB32C | I/O |
| AK10 | PB26A | PB32A | I/O |
| AL10 | PB25A | PB31A | I/O |
| AJ11 | PB24D | PB30D | I/O |
| AH12 | PB24A | PB30A | I/O |
| AK11 | PB23D | PB29D | I/O |
| AL11 | PB23A | PB29A | I/O-LDC |
| AJ12 | PB22D | PB28D | I/O |
| AH13 | PB22B | PB27D | I/O |
| AK12 | PB22A | PB27A | I/O |
| AJ13 | PB21D | PB26D | I/O |
| AK13 | PB21B | PB25D | I/O |
| AH14 | PB21A | PB25A | I/O-HDC |
| AL13 | PB20D | PB24D | I/O |

Pin Information (continued)

Table 27. 432-Pin EPGA Pinout (continued)

| Pin | OR3L165B | OR3L225B | Function |
|------|----------|----------|----------|
| AJ14 | PB20B | PB24B | I/O |
| AK14 | PB20A | PB24A | I/O |
| AL14 | PB19D | PB23D | I/O |
| AJ15 | VDD2 | VDD2 | VDD2 |
| AK15 | PB18D | PB22D | I/O |
| AL15 | PB18B | PB21D | I/O |
| AK16 | PB17D | PB20D | I/O |
| AH16 | PECKB | PECKB | I/O-ECKB |
| AJ16 | PB16D | PB19D | I/O |
| AL17 | PB16B | PB18D | I/O |
| AK17 | PB15D | PB17D | I/O |
| AJ17 | PB15A | PB17A | I/O |
| AL18 | PB14D | PB16D | I/O |
| AK18 | PB14B | PB15D | I/O |
| AJ18 | PB14A | PB15A | I/O |
| AL19 | PB13D | PB14D | I/O |
| AH18 | PB13A | PB13A | I/O |
| AK19 | PB12D | PB12D | I/O |
| AJ19 | PB12B | PB12B | I/O |
| AK20 | PB12A | PB12A | I/O |
| AH19 | PB11D | PB11D | I/O |
| AJ20 | PB11B | PB11B | I/O |
| AL21 | VDD2 | VDD2 | VDD2 |
| AK21 | PB10D | PB10D | I/O |
| AH20 | PB10A | PB10A | I/O |
| AJ21 | PB9D | PB9D | I/O |
| AL22 | PB9A | PB9A | I/O |
| AK22 | PB8D | PB8D | I/O |
| AJ22 | PB8A | PB8A | I/O |
| AL23 | PB7D | PB7D | I/O |
| AK23 | PB7A | PB7A | I/O |
| AH22 | PB6D | PB6D | I/O |
| AJ23 | PB6C | PB6C | I/O |
| AK24 | PB6B | PB6B | I/O |
| AJ24 | PB6A | PB6A | I/O |
| AH23 | PB5D | PB5D | I/O-A17 |
| AL25 | PB5C | PB5C | I/O |
| AK25 | PB5B | PB5B | I/O |
| AJ25 | PB5A | PB5A | I/O |
| AH24 | PB4D | PB4D | I/O |
| AL26 | PB4C | PB4C | I/O |

Pin Information (continued)

Table 27. 432-Pin EPGA Pinout (continued)

| Pin | OR3L165B | OR3L225B | Function |
|------|----------|----------|-----------------|
| AK26 | PB4B | PB4B | I/O |
| AJ26 | PB4A | PB4A | I/O |
| AL27 | VDD2 | VDD2 | VDD2 |
| AK27 | PB3C | PB3C | I/O |
| AJ27 | PB3B | PB3B | I/O |
| AH26 | PB3A | PB3A | I/O |
| AL28 | PB2D | PB2D | I/O |
| AK28 | PB2A | PB2A | I/O |
| AJ28 | PB1B | PB1B | I/O |
| AH27 | PB1A | PB1A | I/O-A16 |
| AG28 | PCCLK | PCCLK | CCLK |
| AH29 | PL32A | PL38A | I/O-A15 |
| AH30 | PL32B | PL38B | I/O |
| AH31 | PL32C | PL38C | I/O |
| AF28 | PL31A | PL37A | I/O |
| AG29 | PL30A | PL36A | I/O-SECKLL |
| AG30 | PL30B | PL36B | I/O |
| AG31 | PL30C | PL36C | I/O |
| AF29 | PL30D | PL36D | I/O |
| AF30 | PL29A | PL35A | I/O |
| AF31 | PL29B | PL35B | I/O |
| AD28 | PL29C | PL35C | I/O |
| AE29 | VDD2 | VDD2 | VDD2 |
| AE30 | PL28A | PL34A | I/O |
| AE31 | PL28B | PL34B | I/O |
| AC28 | PL28C | PL34C | I/O |
| AD29 | PL27A | PL33A | I/O-A14 |
| AD30 | PL27D | PL33D | I/O |
| AC29 | PL26D | PL32D | I/O |
| AB28 | PL25C | PL31C | I/O |
| AC30 | PL25D | PL31D | I/O |
| AC31 | PL24A | PL30A | I/O |
| AB29 | PL24B | PL30B | I/O-A13 |
| AB30 | PL24C | PL30C | I/O |
| AB31 | PL24D | PL30D | I/O |
| AA29 | PL23A | PL29C | I/O |
| Y28 | PL23B | PL29D | I/O |
| AA30 | PL23C | PL28B | I/O |
| AA31 | PL23D | PL28D | I/O-A12 |
| Y29 | PL22A | PL27A | I/O-A11/MPI_IRQ |
| W28 | PL22D | PL27D | I/O |

Pin Information (continued)

Table 27. 432-Pin EPGA Pinout (continued)

| Pin | OR3L165B | OR3L225B | Function |
|-----|----------|----------|----------------|
| Y30 | PL21A | PL26A | I/O |
| W29 | PL21C | PL26C | I/O |
| W30 | PL21D | PL26D | I/O |
| V28 | PL20A | PL25A | I/O-A10/MPI_BI |
| W31 | PL20C | PL24A | I/O |
| V29 | PL20D | PL24D | I/O |
| V30 | PL19A | PL23A | I/O |
| V31 | PL19C | PL22A | I/O |
| U29 | PL19D | PL22D | I/O-A9/MPI_ACK |
| U30 | PL18A | PL21A | I/O-A8/MPI_RW |
| U31 | PL18C | PL21C | I/O |
| T30 | VDD2 | VDD2 | VDD2 |
| T28 | PL17D | PL20D | I/O |
| T29 | PL16A | PL19A | I/O-A7/MPI_CLK |
| R31 | PL16C | PL19C | I/O |
| R30 | PL15A | PL18A | I/O |
| R29 | PECKL | PECKL | I/O-ECKL |
| P31 | PL14A | PL17A | I/O-A6 |
| P30 | PL14D | PL16D | I/O |
| P29 | PL13A | PL15A | I/O |
| N31 | PL13C | PL14A | I/O |
| P28 | PL13D | PL14D | I/O-A5 |
| N30 | PL12A | PL13A | I/O-A4 |
| N29 | PL12C | PL13C | I/O |
| M30 | PL12D | PL13D | I/O |
| N28 | PL11A | PL12A | I/O |
| M29 | PL11C | PL12C | I/O |
| L31 | VDD2 | VDD2 | VDD2 |
| L30 | PL10A | PL11A | I/O-A3 |
| M28 | PL10B | PL11D | I/O |
| L29 | PL10C | PL10A | I/O |
| K31 | PL10D | PL10D | I/O |
| K30 | PL9A | PL9A | I/O-A2 |
| K29 | PL9B | PL9B | I/O |
| J31 | PL9C | PL9C | I/O |
| J30 | PL9D | PL9D | I/O |
| K28 | PL8D | PL8D | I/O-A1/MPI_BE1 |
| J29 | PL7B | PL7B | I/O |
| H30 | PL7C | PL7C | I/O |
| H29 | PL7D | PL7D | I/O |
| J28 | PL6D | PL6D | I/O |

Pin Information (continued)

Table 27. 432-Pin EPGA Pinout (continued)

| Pin | OR3L165B | OR3L225B | Function |
|-----|----------|----------|----------------|
| G31 | PL5B | PL5B | I/O |
| G30 | PL5C | PL5C | I/O |
| G29 | VDD2 | VDD2 | VDD2 |
| H28 | PL4A | PL4A | I/O |
| F31 | PL4B | PL4B | I/O |
| F30 | PL4C | PL4C | I/O |
| F29 | PL4D | PL4D | I/O |
| E31 | PL3A | PL3A | I/O |
| E30 | PL3B | PL3B | I/O |
| E29 | PL3C | PL3C | I/O |
| F28 | PL3D | PL3D | I/O-A0/MPI_BE0 |
| D31 | PL2A | PL2A | I/O |
| D30 | PL2D | PL2D | I/O |
| D29 | PL1A | PL1A | I/O |
| E28 | PL1D | PL1D | I/O |
| D27 | PRD_DATA | PRD_DATA | RD_DATA/TDO |
| C28 | PT1A | PT1A | I/O-TCK |
| B28 | PT1D | PT1D | I/O |
| A28 | PT2A | PT2A | I/O |
| D26 | PT2D | PT2D | I/O |
| C27 | PT3A | PT3A | I/O |
| B27 | PT3B | PT3B | I/O |
| A27 | PT3C | PT3C | I/O |
| C26 | PT3D | PT3D | I/O |
| B26 | PT4A | PT4A | I/O |
| A26 | PT4B | PT4B | I/O |
| D24 | PT4C | PT4C | I/O |
| C25 | PT4D | PT4D | I/O |
| B25 | PT5A | PT5A | I/O-TMS |
| A25 | PT5B | PT5B | I/O |
| D23 | PT5C | PT5C | I/O |
| C24 | PT5D | PT5D | I/O |
| B24 | VDD2 | VDD2 | VDD2 |
| C23 | PT6B | PT6B | I/O |
| D22 | PT6C | PT6C | I/O |
| B23 | PT6D | PT6D | I/O |
| A23 | PT7A | PT7A | I/O-TDI |
| C22 | PT7D | PT7D | I/O |
| B22 | PT8A | PT8A | I/O |
| A22 | PT8D | PT8D | I/O |
| C21 | PT9A | PT9A | I/O |

Pin Information (continued)

Table 27. 432-Pin EPGA Pinout (continued)

| Pin | OR3L165B | OR3L225B | Function |
|-----|----------|----------|------------|
| D20 | PT9D | PT9D | I/O |
| B21 | PT10A | PT10A | I/O |
| A21 | PT10D | PT10D | I/O |
| C20 | PT11A | PT11A | I/O-DOUT |
| D19 | PT11D | PT12D | I/O |
| B20 | PT12A | PT13A | I/O |
| C19 | PT12C | PT14A | I/O |
| B19 | PT12D | PT14D | I/O |
| D18 | PT13A | PT15A | I/O-D0/DIN |
| A19 | PT13C | PT15C | I/O |
| C18 | PT13D | PT15D | I/O |
| B18 | PT14A | PT16A | I/O |
| A18 | PT14C | PT16C | I/O |
| C17 | PT14D | PT16D | I/O-D1 |
| B17 | PT15A | PT17A | I/O-D2 |
| A17 | VDD2 | VDD2 | VDD2 |
| B16 | PT16C | PT18D | I/O |
| D16 | PT16D | PT19D | I/O |
| C16 | PT17A | PT20A | I/O-D3 |
| A15 | PT17D | PT21A | I/O |
| B15 | PT18B | PT22A | I/O |
| C15 | PECKT | PECKT | I/O-ECKT |
| A14 | PT19A | PT23A | I/O-D4 |
| B14 | PT19B | PT23D | I/O |
| C14 | PT19D | PT24D | I/O |
| A13 | PT20A | PT25A | I/O |
| D14 | PT20B | PT25D | I/O |
| B13 | PT20D | PT26D | I/O |
| C13 | PT21A | PT27A | I/O-D5 |
| B12 | PT21B | PT27B | I/O |
| D13 | VDD2 | VDD2 | VDD2 |
| C12 | PT22A | PT28A | I/O |
| A11 | PT22D | PT28D | I/O |
| B11 | PT23A | PT29A | I/O |
| D12 | PT23D | PT29D | I/O-D6 |
| C11 | PT24A | PT30A | I/O |
| A10 | PT24D | PT30D | I/O |
| B10 | PT25D | PT31D | I/O |
| C10 | PT26B | PT32B | I/O |
| A9 | PT26C | PT32C | I/O |
| B9 | VDD2 | VDD2 | VDD2 |

Pin Information (continued)

Table 27. 432-Pin EBGA Pinout (continued)

| Pin | OR3L165B | OR3L225B | Function |
|------|----------|----------|----------------------|
| D10 | PT27A | PT33A | I/O |
| C9 | PT27B | PT33B | I/O |
| B8 | PT27C | PT33C | I/O |
| C8 | PT27D | PT33D | I/O-D7 |
| D9 | PT28A | PT34A | I/O |
| A7 | PT28B | PT34B | I/O |
| B7 | PT28C | PT34C | I/O |
| C7 | PT28D | PT34D | I/O |
| D8 | PT29A | PT35A | I/O |
| A6 | PT29B | PT35B | I/O |
| B6 | PT29C | PT35C | I/O |
| C6 | PT29D | PT35D | I/O |
| A5 | PT30A | PT36A | I/O-RDY/RCLK/MPL_ALE |
| B5 | PT30B | PT36B | I/O |
| C5 | PT30C | PT36C | I/O |
| D6 | PT30D | PT36D | I/O |
| A4 | PT31A | PT37A | I/O |
| B4 | PT31B | PT37B | I/O |
| C4 | PT32A | PT38A | I/O |
| D5 | PT32D | PT38D | I/O-SECKUR |
| A12 | Vss | Vss | Vss |
| A16 | Vss | Vss | Vss |
| A2 | Vss | Vss | Vss |
| A20 | Vss | Vss | Vss |
| A24 | Vss | Vss | Vss |
| A29 | Vss | Vss | Vss |
| A3 | Vss | Vss | Vss |
| A30 | Vss | Vss | Vss |
| A8 | Vss | Vss | Vss |
| AD1 | Vss | Vss | Vss |
| AD31 | Vss | Vss | Vss |
| AJ1 | Vss | Vss | Vss |
| AJ2 | Vss | Vss | Vss |
| AJ30 | Vss | Vss | Vss |
| AJ31 | Vss | Vss | Vss |
| AK1 | Vss | Vss | Vss |
| AK29 | Vss | Vss | Vss |
| AK3 | Vss | Vss | Vss |
| AK31 | Vss | Vss | Vss |
| AL12 | Vss | Vss | Vss |
| AL16 | Vss | Vss | Vss |

Pin Information (continued)

Table 27. 432-Pin EPGA Pinout (continued)

| Pin | OR3L165B | OR3L225B | Function |
|------|----------|----------|----------|
| AL2 | VSS | VSS | VSS |
| AL20 | VSS | VSS | VSS |
| AL24 | VSS | VSS | VSS |
| AL29 | VSS | VSS | VSS |
| AL3 | VSS | VSS | VSS |
| AL30 | VSS | VSS | VSS |
| AL8 | VSS | VSS | VSS |
| B1 | VSS | VSS | VSS |
| B29 | VSS | VSS | VSS |
| B3 | VSS | VSS | VSS |
| B31 | VSS | VSS | VSS |
| C1 | VSS | VSS | VSS |
| C2 | VSS | VSS | VSS |
| C30 | VSS | VSS | VSS |
| C31 | VSS | VSS | VSS |
| H1 | VSS | VSS | VSS |
| H31 | VSS | VSS | VSS |
| M1 | VSS | VSS | VSS |
| M31 | VSS | VSS | VSS |
| T1 | VSS | VSS | VSS |
| T31 | VSS | VSS | VSS |
| Y1 | VSS | VSS | VSS |
| Y31 | VSS | VSS | VSS |
| A1 | VDD | VDD | VDD |
| A31 | VDD | VDD | VDD |
| AA28 | VDD | VDD | VDD |
| AA4 | VDD | VDD | VDD |
| AE28 | VDD | VDD | VDD |
| AE4 | VDD | VDD | VDD |
| AH11 | VDD | VDD | VDD |
| AH15 | VDD | VDD | VDD |
| AH17 | VDD | VDD | VDD |
| AH21 | VDD | VDD | VDD |
| AH25 | VDD | VDD | VDD |
| AH28 | VDD | VDD | VDD |
| AH4 | VDD | VDD | VDD |
| AH7 | VDD | VDD | VDD |
| AJ29 | VDD | VDD | VDD |
| AJ3 | VDD | VDD | VDD |
| AK2 | VDD | VDD | VDD |
| AK30 | VDD | VDD | VDD |

Pin Information (continued)

Table 27. 432-Pin EBGA Pinout (continued)

| Pin | OR3L165B | OR3L225B | Function |
|------|----------|----------|----------|
| AL1 | VDD | VDD | VDD |
| AL31 | VDD | VDD | VDD |
| B2 | VDD | VDD | VDD |
| B30 | VDD | VDD | VDD |
| C29 | VDD | VDD | VDD |
| C3 | VDD | VDD | VDD |
| D11 | VDD | VDD | VDD |
| D15 | VDD | VDD | VDD |
| D17 | VDD | VDD | VDD |
| D21 | VDD | VDD | VDD |
| D25 | VDD | VDD | VDD |
| D28 | VDD | VDD | VDD |
| D4 | VDD | VDD | VDD |
| D7 | VDD | VDD | VDD |
| G28 | VDD | VDD | VDD |
| G4 | VDD | VDD | VDD |
| L28 | VDD | VDD | VDD |
| L4 | VDD | VDD | VDD |
| R28 | VDD | VDD | VDD |
| R4 | VDD | VDD | VDD |
| U28 | VDD | VDD | VDD |
| U4 | VDD | VDD | VDD |

ALL DEVICES DISCONTINUED

Pin Information (continued)

Table 28. 680-Pin PBGAM Pinout

| Pin | OR3L165B | OR3L225B | Function |
|-----|----------|----------|----------------|
| D1 | PL1D | PL1D | I/O |
| E2 | PL1C | PL1C | I/O |
| E1 | PL1B | PL1B | I/O |
| F4 | PL1A | PL1A | I/O |
| F3 | PL2D | PL2D | I/O |
| F2 | PL2A | PL2A | I/O |
| F1 | PL3D | PL3D | I/O-A0/MPI_BE0 |
| G5 | PL3C | PL3C | I/O |
| G4 | PL3B | PL3B | I/O |
| G2 | PL3A | PL3A | I/O |
| G1 | PL4D | PL4D | I/O |
| H5 | PL4C | PL4C | I/O |
| H4 | PL4B | PL4B | I/O |
| H2 | PL4A | PL4A | I/O |
| H1 | PL5C | PL5C | I/O |
| J5 | PL5B | PL5B | I/O |
| J4 | PL5A | PL5A | I/O |
| J3 | PL6D | PL6D | I/O |
| J2 | PL6C | PL6C | I/O |
| J1 | PL6B | PL6B | I/O |
| K5 | PL6A | PL6A | I/O |
| K4 | PL7D | PL7D | I/O |
| K3 | PL7C | PL7C | I/O |
| K2 | PL7B | PL7B | I/O |
| K1 | PL7A | PL7A | I/O |
| L5 | PL8D | PL8D | I/O-A1/MPI_BE1 |
| L4 | PL8C | PL8C | I/O |
| L2 | PL8B | PL8B | I/O |
| L1 | PL8A | PL8A | I/O |
| M5 | PL9D | PL9D | I/O |
| M4 | PL9C | PL9C | I/O |
| M2 | PL9B | PL9B | I/O |
| M1 | PL9A | PL9A | I/O-A2 |
| N5 | PL10D | PL10D | I/O |
| N4 | PL10C | PL10A | I/O |
| N3 | PL10B | PL11D | I/O |
| N2 | PL10A | PL11A | I/O-A3 |
| N1 | PL11C | PL12C | I/O |
| P5 | PL11B | PL12B | I/O |
| P4 | PL11A | PL12A | I/O |
| P3 | PL12D | PL13D | I/O |
| P2 | PL12C | PL13C | I/O |
| P1 | PL12B | PL13B | I/O |

Pin Information (continued)

Table 28. 680-Pin PBGAM Pinout (continued)

| Pin | OR3L165B | OR3L225B | Function |
|-----|----------|----------|-----------------|
| R5 | PL12A | PL13A | I/O-A4 |
| R4 | PL13D | PL14D | I/O-A5 |
| R2 | PL13C | PL14A | I/O |
| R1 | PL13B | PL15D | I/O |
| T5 | PL14D | PL16D | I/O |
| T4 | PL14C | PL16A | I/O |
| T2 | PL14B | PL17D | I/O |
| T1 | PL14A | PL17A | I/O-A6 |
| U5 | PECKL | PECKL | I/O-ECKL |
| U4 | PL15C | PL18C | I/O |
| U3 | PL15A | PL18A | I/O |
| U2 | PL16C | PL19C | I/O |
| U1 | PL16A | PL19A | I/O-A7/MPI_CLK |
| V1 | PL17D | PL20D | I/O |
| V2 | PL18C | PL21C | I/O |
| V3 | PL18A | PL21A | I/O-A8/MPI_RW |
| V4 | PL19D | PL22D | I/O-A9/MPI_ACK |
| V5 | PL19C | PL22A | I/O |
| W1 | PL19B | PL23D | I/O |
| W2 | PL19A | PL23A | I/O |
| W4 | PL20D | PL24D | I/O |
| W5 | PL20C | PL24A | I/O |
| Y1 | PL20B | PL25D | I/O |
| Y2 | PL20A | PL25A | I/O-A10/MPI_B1 |
| Y4 | PL21D | PL26D | I/O |
| Y5 | PL21C | PL26C | I/O |
| AA1 | PL21B | PL26B | I/O |
| AA2 | PL21A | PL26A | I/O |
| AA3 | PL22D | PL27D | I/O |
| AA4 | PL22C | PL27C | I/O |
| AA5 | PL22B | PL27B | I/O |
| AB1 | PL22A | PL27A | I/O-A11/MPI_IRQ |
| AB2 | PL23D | PL28D | I/O-A12 |
| AB3 | PL23C | PL28B | I/O |
| AB4 | PL23A | PL29C | I/O |
| AB5 | PL24D | PL30D | I/O |
| AC1 | PL24C | PL30C | I/O |
| AC2 | PL24B | PL30B | I/O-A13 |
| AC4 | PL24A | PL30A | I/O |
| AC5 | PL25D | PL31D | I/O |
| AD1 | PL25C | PL31C | I/O |
| AD2 | PL25B | PL31B | I/O |
| AD4 | PL25A | PL31A | I/O |

Pin Information (continued)

Table 28. 680-Pin PBGAM Pinout (continued)

| Pin | OR3L165B | OR3L225B | Function |
|-----|----------|----------|------------|
| AD5 | PL26D | PL32D | I/O |
| AE1 | PL26C | PL32C | I/O |
| AE2 | PL26B | PL32B | I/O |
| AE3 | PL26A | PL32A | I/O |
| AE4 | PL27D | PL33D | I/O |
| AE5 | PL27C | PL33C | I/O |
| AF1 | PL27B | PL33B | I/O |
| AF2 | PL27A | PL33A | I/O-A14 |
| AF3 | PL28D | PL34D | I/O |
| AF4 | PL28C | PL34C | I/O |
| AF5 | PL28B | PL34B | I/O |
| AG1 | PL28A | PL34A | I/O |
| AG2 | PL29C | PL35C | I/O |
| AG4 | PL29B | PL35B | I/O |
| AG5 | PL29A | PL35A | I/O |
| AH1 | PL30D | PL36D | I/O |
| AH2 | PL30C | PL36C | I/O |
| AH4 | PL30B | PL36B | I/O |
| AH5 | PL30A | PL36A | I/O-SECKLL |
| AJ1 | PL31D | PL37D | I/O |
| AJ2 | PL31C | PL37C | I/O |
| AJ3 | PL31A | PL37A | I/O |
| AJ4 | PL32C | PL38C | I/O |
| AK1 | PL32B | PL38B | I/O |
| AK2 | PL32A | PL38A | I/O-A15 |
| AL1 | PCCLK | PCCLK | CCLK |
| AP4 | PB1A | PB1A | I/O-A16 |
| AN5 | PB1B | PB1B | I/O |
| AP5 | PB1C | PB1C | I/O |
| AL6 | PB1D | PB1D | I/O |
| AM6 | PB2A | PB2A | I/O |
| AN6 | PB2D | PB2D | I/O |
| AP6 | PB3A | PB3A | I/O |
| AK7 | PB3B | PB3B | I/O |
| AL7 | PB3C | PB3C | I/O |
| AN7 | PB4A | PB4A | I/O |
| AP7 | PB4B | PB4B | I/O |
| AK8 | PB4C | PB4C | I/O |
| AL8 | PB4D | PB4D | I/O |
| AN8 | PB5A | PB5A | I/O |
| AP8 | PB5B | PB5B | I/O |
| AK9 | PB5C | PB5C | I/O |
| AL9 | PB5D | PB5D | I/O-A17 |

Pin Information (continued)

Table 28. 680-Pin PBGAM Pinout (continued)

| Pin | OR3L165B | OR3L225B | Function |
|------|----------|----------|----------|
| AM9 | PB6A | PB6A | I/O |
| AN9 | PB6B | PB6B | I/O |
| AP9 | PB6C | PB6C | I/O |
| AK10 | PB6D | PB6D | I/O |
| AL10 | PB7A | PB7A | I/O |
| AM10 | PB7B | PB7B | I/O |
| AN10 | PB7C | PB7C | I/O |
| AP10 | PB7D | PB7D | I/O |
| AK11 | PB8A | PB8A | I/O |
| AL11 | PB8B | PB8B | I/O |
| AN11 | PB8C | PB8C | I/O |
| AP11 | PB8D | PB8D | I/O |
| AK12 | PB9A | PB9A | I/O |
| AL12 | PB9B | PB9B | I/O |
| AN12 | PB9C | PB9C | I/O |
| AP12 | PB9D | PB9D | I/O |
| AK13 | PB10A | PB10A | I/O |
| AL13 | PB10B | PB10B | I/O |
| AM13 | PB10C | PB10C | I/O |
| AN13 | PB10D | PB10D | I/O |
| AP13 | PB11B | PB11B | I/O |
| AK14 | PB11C | PB11C | I/O |
| AL14 | PB11D | PB11D | I/O |
| AM14 | PB12A | PB12A | I/O |
| AN14 | PB12B | PB12B | I/O |
| AP14 | PB12C | PB12C | I/O |
| AK15 | PB12D | PB12D | I/O |
| AL15 | PB13A | PB13A | I/O |
| AN15 | PB13B | PB13D | I/O |
| AP15 | PB13C | PB14A | I/O |
| AK16 | PB13D | PB14D | I/O |
| AL16 | PB14A | PB15A | I/O |
| AN16 | PB14B | PB15D | I/O |
| AP16 | PB14C | PB16A | I/O |
| AK17 | PB14D | PB16D | I/O |
| AL17 | PB15B | PB17B | I/O |
| AM17 | PB15D | PB17D | I/O |
| AN17 | PB16A | PB18A | I/O |
| AP17 | PB16B | PB18D | I/O |
| AP18 | PB16D | PB19D | I/O |
| AN18 | PECKB | PECKB | I/O-ECKB |
| AM18 | PB17D | PB20D | I/O |
| AL18 | PB18B | PB21D | I/O |

Pin Information (continued)

Table 28. 680-Pin PBGAM Pinout (continued)

| Pin | OR3L165B | OR3L225B | Function |
|------|----------|----------|----------|
| AK18 | PB18D | PB22D | I/O |
| AP19 | PB19B | PB23B | I/O |
| AN19 | PB19C | PB23C | I/O |
| AL19 | PB19D | PB23D | I/O |
| AK19 | PB20A | PB24A | I/O |
| AP20 | PB20B | PB24B | I/O |
| AN20 | PB20C | PB24C | I/O |
| AL20 | PB20D | PB24D | I/O |
| AK20 | PB21A | PB25A | I/O-HDC |
| AP21 | PB21B | PB25D | I/O |
| AN21 | PB21C | PB26A | I/O |
| AM21 | PB21D | PB26D | I/O |
| AL21 | PB22A | PB27A | I/O |
| AK21 | PB22B | PB27D | I/O |
| AP22 | PB22C | PB28A | I/O |
| AN22 | PB23A | PB29A | I/O-LDC |
| AM22 | PB23B | PB29B | I/O |
| AL22 | PB23C | PB29C | I/O |
| AK22 | PB23D | PB29D | I/O |
| AP23 | PB24A | PB30A | I/O |
| AN23 | PB24B | PB30B | I/O |
| AL23 | PB24C | PB30C | I/O |
| AK23 | PB24D | PB30D | I/O |
| AP24 | PB25A | PB31A | I/O |
| AN24 | PB25B | PB31B | I/O |
| AL24 | PB25C | PB31C | I/O |
| AK24 | PB25D | PB31D | I/O |
| AP25 | PB26A | PB32A | I/O |
| AN25 | PB26B | PB32B | I/O |
| AM25 | PB26C | PB32C | I/O |
| AL25 | PB26D | PB32D | I/O |
| AK25 | PB27A | PB33A | I/O-INIT |
| AP26 | PB27B | PB33B | I/O |
| AN26 | PB27C | PB33C | I/O |
| AM26 | PB27D | PB33D | I/O |
| AL26 | PB28B | PB34B | I/O |
| AK26 | PB28C | PB34C | I/O |
| AP27 | PB28D | PB34D | I/O |
| AN27 | PB29A | PB35A | I/O |
| AL27 | PB29B | PB35B | I/O |
| AK27 | PB29C | PB35C | I/O |
| AP28 | PB29D | PB35D | I/O |
| AN28 | PB30A | PB36A | I/O |

Pin Information (continued)

Table 28. 680-Pin PBGAM Pinout (continued)

| Pin | OR3L165B | OR3L225B | Function |
|------|----------|----------|----------|
| AL28 | PB30B | PB36B | I/O |
| AK28 | PB30C | PB36C | I/O |
| AP29 | PB30D | PB36D | I/O |
| AN29 | PB31A | PB37A | I/O |
| AM29 | PB31D | PB37D | I/O |
| AL29 | PB32A | PB38A | I/O |
| AP30 | PB32C | PB38C | I/O |
| AN30 | PB32D | PB38D | I/O |
| AP31 | PDONE | PDONE | DONE |
| AL34 | PRESETN | PRESETN | RESET |
| AK33 | PPRGMN | PPRGMN | PRGM |
| AK34 | PR32A | PR38A | I/O-M0 |
| AJ31 | PR32B | PR38B | I/O |
| AJ32 | PR31A | PR37A | I/O |
| AJ33 | PR31D | PR37D | I/O |
| AJ34 | PR30B | PR36B | I/O |
| AH30 | PR30C | PR36C | I/O |
| AH31 | PR30D | PR36D | I/O |
| AH33 | PR29A | PR35A | I/O |
| AH34 | PR29B | PR35B | I/O |
| AG30 | PR29C | PR35C | I/O |
| AG31 | PR29D | PR35D | I/O |
| AG33 | PR28A | PR34A | I/O |
| AG34 | PR28B | PR34B | I/O |
| AF30 | PR28C | PR34C | I/O |
| AF31 | PR28D | PR34D | I/O |
| AF32 | PR27A | PR33A | I/O |
| AF33 | PR27B | PR33B | I/O |
| AF34 | PR27C | PR33C | I/O |
| AE30 | PR27D | PR33D | I/O |
| AE31 | PR26A | PR32A | I/O |
| AE32 | PR26B | PR32B | I/O |
| AE33 | PR26C | PR32C | I/O |
| AE34 | PR26D | PR32D | I/O |
| AD30 | PR25A | PR31A | I/O |
| AD31 | PR25B | PR31B | I/O |
| AD33 | PR25C | PR31C | I/O |
| AD34 | PR25D | PR31D | I/O-M1 |
| AC30 | PR24A | PR30A | I/O |
| AC31 | PR24B | PR30D | I/O |
| AC33 | PR24C | PR29A | I/O |
| AC34 | PR23A | PR28A | I/O |
| AB30 | PR23B | PR28B | I/O |

Pin Information (continued)

Table 28. 680-Pin PBGAM Pinout (continued)

| Pin | OR3L165B | OR3L225B | Function |
|------|----------|----------|----------|
| AB31 | PR23C | PR28C | I/O |
| AB32 | PR23D | PR28D | I/O |
| AB33 | PR22A | PR27A | I/O-M2 |
| AB34 | PR22B | PR27B | I/O |
| AA30 | PR22C | PR27C | I/O |
| AA31 | PR22D | PR27D | I/O |
| AA32 | PR21A | PR26A | I/O |
| AA33 | PR21B | PR26B | I/O |
| AA34 | PR21C | PR26C | I/O |
| Y30 | PR21D | PR26D | I/O |
| Y31 | PR20A | PR25A | I/O-M3 |
| Y33 | PR20B | PR25D | I/O |
| Y34 | PR20C | PR24A | I/O |
| W30 | PR20D | PR24D | I/O |
| W31 | PR19A | PR23A | I/O |
| W33 | PR19B | PR23D | I/O |
| W34 | PR19C | PR22B | I/O |
| V30 | PR18A | PR21A | I/O |
| V31 | PR18B | PR21B | I/O |
| V32 | PR18D | PR21D | I/O |
| V33 | PR17B | PR20B | I/O |
| V34 | PR17D | PR20D | I/O |
| U34 | PECKR | PECKR | I/O-ECKR |
| U33 | PR16D | PR19D | I/O |
| U32 | PR15B | PR18B | I/O |
| U31 | PR15D | PR18D | I/O |
| U30 | PR14B | PR17D | I/O |
| T34 | PR14C | PR16A | I/O |
| T33 | PR14D | PR16D | I/O |
| T31 | PR13A | PR15A | I/O |
| T30 | PR13B | PR15D | I/O |
| R34 | PR13C | PR14A | I/O |
| R33 | PR13D | PR14D | I/O |
| R31 | PR12A | PR13A | I/O-CS1 |
| R30 | PR12B | PR13B | I/O |
| P34 | PR12C | PR13C | I/O |
| P33 | PR12D | PR13D | I/O |
| P32 | PR11A | PR12A | I/O |
| P31 | PR11B | PR12B | I/O |
| P30 | PR11C | PR12C | I/O |
| N34 | PR10A | PR11A | I/O-CS0 |
| N33 | PR10B | PR11C | I/O |
| N32 | PR10C | PR11D | I/O |

Pin Information (continued)

Table 28. 680-Pin PBGAM Pinout (continued)

| Pin | OR3L165B | OR3L225B | Function |
|-----|----------|----------|-----------------|
| N31 | PR10D | PR10A | I/O |
| N30 | PR9A | PR10C | I/O |
| M34 | PR9B | PR10D | I/O |
| M33 | PR9C | PR9A | I/O |
| M31 | PR9D | PR9D | I/O |
| M30 | PR8A | PR8A | I/O-RD/MPI_STRB |
| L34 | PR8B | PR8B | I/O |
| L33 | PR8C | PR8C | I/O |
| L31 | PR8D | PR8D | I/O |
| L30 | PR7A | PR7A | I/O |
| K34 | PR7B | PR7B | I/O |
| K33 | PR7C | PR7C | I/O |
| K32 | PR7D | PR7D | I/O |
| K31 | PR6A | PR6A | I/O |
| K30 | PR6B | PR6B | I/O |
| J34 | PR6C | PR6C | I/O |
| J33 | PR6D | PR6D | I/O |
| J32 | PR5B | PR5B | I/O |
| J31 | PR5C | PR5C | I/O |
| J30 | PR5D | PR5D | I/O |
| H34 | PR4A | PR4A | I/O-WR |
| H33 | PR4B | PR4B | I/O |
| H31 | PR4C | PR4C | I/O |
| H30 | PR4D | PR4D | I/O |
| G34 | PR3A | PR3A | I/O |
| G33 | PR3B | PR3B | I/O |
| G31 | PR3C | PR3C | I/O |
| G30 | PR3D | PR3D | I/O |
| F34 | PR2A | PR2A | I/O |
| F33 | PR2B | PR2B | I/O |
| F32 | PR2D | PR2D | I/O |
| F31 | PR1A | PR1A | I/O |
| E34 | PR1B | PR1B | I/O |
| E33 | PR1D | PR1D | I/O |
| D34 | PRD_CFGN | PRD_CFGN | RD_CFG |
| A31 | PT32D | PT38D | I/O-SECKUR |
| B30 | PT32C | PT38C | I/O |
| A30 | PT32A | PT38A | I/O |
| D29 | PT31D | PT37D | I/O |
| C29 | PT31B | PT37B | I/O |
| B29 | PT31A | PT37A | I/O |
| A29 | PT30D | PT36D | I/O |
| E28 | PT30C | PT36C | I/O |

Pin Information (continued)

Table 28. 680-Pin PBGAM Pinout (continued)

| Pin | OR3L165B | OR3L225B | Function |
|-----|----------|----------|----------------------|
| D28 | PT30B | PT36B | I/O |
| B28 | PT30A | PT36A | I/O-RDY/RCLK/MPI_ALE |
| A28 | PT29D | PT35D | I/O |
| E27 | PT29C | PT35C | I/O |
| D27 | PT29B | PT35B | I/O |
| B27 | PT29A | PT35A | I/O |
| A27 | PT28D | PT34D | I/O |
| E26 | PT28C | PT34C | I/O |
| D26 | PT28B | PT34B | I/O |
| C26 | PT28A | PT34A | I/O |
| B26 | PT27D | PT33D | I/O-D7 |
| A26 | PT27C | PT33C | I/O |
| E25 | PT27B | PT33B | I/O |
| D25 | PT27A | PT33A | I/O |
| C25 | PT26C | PT32C | I/O |
| B25 | PT26B | PT32B | I/O |
| A25 | PT26A | PT32A | I/O |
| E24 | PT25D | PT31D | I/O |
| D24 | PT25C | PT31C | I/O |
| B24 | PT25B | PT31B | I/O |
| A24 | PT25A | PT31A | I/O |
| E23 | PT24D | PT30D | I/O |
| D23 | PT24C | PT30C | I/O |
| B23 | PT24B | PT30B | I/O |
| A23 | PT24A | PT30A | I/O |
| E22 | PT23D | PT29D | I/O-D6 |
| D22 | PT23C | PT29C | I/O |
| C22 | PT23B | PT29B | I/O |
| B22 | PT23A | PT29A | I/O |
| A22 | PT22D | PT28D | I/O |
| E21 | PT22C | PT28C | I/O |
| D21 | PT22B | PT28B | I/O |
| C21 | PT22A | PT28A | I/O |
| B21 | PT21C | PT27C | I/O |
| A21 | PT21B | PT27B | I/O |
| E20 | PT21A | PT27A | I/O-D5 |
| D20 | PT20D | PT26D | I/O |
| B20 | PT20C | PT26A | I/O |
| A20 | PT20B | PT25D | I/O |
| E19 | PT20A | PT25A | I/O |
| D19 | PT19D | PT24D | I/O |
| B19 | PT19C | PT24A | I/O |
| A19 | PT19B | PT23D | I/O |

Pin Information (continued)

Table 28. 680-Pin PBGAM Pinout (continued)

| Pin | OR3L165B | OR3L225B | Function |
|-----|----------|----------|------------|
| E18 | PT19A | PT23A | I/O-D4 |
| D18 | PECKT | PECKT | I/O-ECKT |
| C18 | PT17D | PT21A | I/O |
| B18 | PT17C | PT20D | I/O |
| A18 | PT17A | PT20A | I/O-D3 |
| A17 | PT16D | PT19D | I/O |
| B17 | PT16C | PT18D | I/O |
| C17 | PT15A | PT17A | I/O-D2 |
| D17 | PT14D | PT16D | I/O-D1 |
| E17 | PT14C | PT16C | I/O |
| A16 | PT14B | PT16B | I/O |
| B16 | PT14A | PT16A | I/O |
| D16 | PT13D | PT15D | I/O |
| E16 | PT13C | PT15C | I/O |
| A15 | PT13B | PT15B | I/O |
| B15 | PT13A | PT15A | I/O-D0/DIN |
| D15 | PT12D | PT14D | I/O |
| E15 | PT12C | PT14A | I/O |
| A14 | PT12B | PT13D | I/O |
| B14 | PT12A | PT13A | I/O |
| C14 | PT11D | PT12D | I/O |
| D14 | PT11C | PT12A | I/O |
| E14 | PT11B | PT11D | I/O |
| A13 | PT11A | PT11A | I/O-DOUT |
| B13 | PT10C | PT10C | I/O |
| C13 | PT10B | PT10B | I/O |
| D13 | PT10A | PT10A | I/O |
| E13 | PT9D | PT9D | I/O |
| A12 | PT9C | PT9C | I/O |
| B12 | PT9B | PT9B | I/O |
| D12 | PT9A | PT9A | I/O |
| E12 | PT8D | PT8D | I/O |
| A11 | PT8C | PT8C | I/O |
| B11 | PT8B | PT8B | I/O |
| D11 | PT8A | PT8A | I/O |
| E11 | PT7D | PT7D | I/O |
| A10 | PT7C | PT7C | I/O |
| B10 | PT7B | PT7B | I/O |
| C10 | PT7A | PT7A | I/O-TDI |
| D10 | PT6D | PT6D | I/O |
| E10 | PT6C | PT6C | I/O |
| A9 | PT6B | PT6B | I/O |
| B9 | PT5D | PT5D | I/O |

Pin Information (continued)

Table 28. 680-Pin PBGAM Pinout (continued)

| Pin | OR3L165B | OR3L225B | Function |
|-----|----------|----------|-------------|
| C9 | PT5C | PT5C | I/O |
| D9 | PT5B | PT5B | I/O |
| E9 | PT5A | PT5A | I/O-TMS |
| A8 | PT4D | PT4D | I/O |
| B8 | PT4C | PT4C | I/O |
| D8 | PT4B | PT4B | I/O |
| E8 | PT4A | PT4A | I/O |
| A7 | PT3D | PT3D | I/O |
| B7 | PT3C | PT3C | I/O |
| D7 | PT3B | PT3B | I/O |
| E7 | PT3A | PT3A | I/O |
| A6 | PT2D | PT2D | I/O |
| B6 | PT2C | PT2C | I/O |
| C6 | PT2A | PT2A | I/O |
| D6 | PT1D | PT1D | I/O |
| A5 | PT1C | PT1C | I/O |
| B5 | PT1A | PT1A | I/O-TCK |
| A4 | PRD_DATA | PRD_DATA | RD_DATA/TDO |
| A1 | Vss | Vss | Vss |
| A2 | Vss | Vss | Vss |
| A33 | Vss | Vss | Vss |
| A34 | Vss | Vss | Vss |
| B1 | Vss | Vss | Vss |
| B2 | Vss | Vss | Vss |
| B33 | Vss | Vss | Vss |
| B34 | Vss | Vss | Vss |
| C3 | Vss | Vss | Vss |
| C8 | Vss | Vss | Vss |
| C12 | Vss | Vss | Vss |
| C16 | Vss | Vss | Vss |
| C19 | Vss | Vss | Vss |
| C23 | Vss | Vss | Vss |
| C27 | Vss | Vss | Vss |
| C32 | Vss | Vss | Vss |
| D4 | Vss | Vss | Vss |
| D31 | Vss | Vss | Vss |
| H3 | Vss | Vss | Vss |
| H32 | Vss | Vss | Vss |
| M3 | Vss | Vss | Vss |
| M32 | Vss | Vss | Vss |
| N13 | Vss | Vss | Vss |
| N14 | Vss | Vss | Vss |
| N15 | Vss | Vss | Vss |

Pin Information (continued)

Table 28. 680-Pin PBGAM Pinout (continued)

| Pin | OR3L165B | OR3L225B | Function |
|------|----------|----------|----------|
| N20 | VSS | VSS | VSS |
| N21 | VSS | VSS | VSS |
| N22 | VSS | VSS | VSS |
| P13 | VSS | VSS | VSS |
| P14 | VSS | VSS | VSS |
| P15 | VSS | VSS | VSS |
| P20 | VSS | VSS | VSS |
| P21 | VSS | VSS | VSS |
| P22 | VSS | VSS | VSS |
| R13 | VSS | VSS | VSS |
| R14 | VSS | VSS | VSS |
| R15 | VSS | VSS | VSS |
| R20 | VSS | VSS | VSS |
| R21 | VSS | VSS | VSS |
| R22 | VSS | VSS | VSS |
| T3 | VSS | VSS | VSS |
| T16 | VSS | VSS | VSS |
| T17 | VSS | VSS | VSS |
| T18 | VSS | VSS | VSS |
| T19 | VSS | VSS | VSS |
| T32 | VSS | VSS | VSS |
| U16 | VSS | VSS | VSS |
| U17 | VSS | VSS | VSS |
| U18 | VSS | VSS | VSS |
| U19 | VSS | VSS | VSS |
| V16 | VSS | VSS | VSS |
| V17 | VSS | VSS | VSS |
| V18 | VSS | VSS | VSS |
| V19 | VSS | VSS | VSS |
| W3 | VSS | VSS | VSS |
| W16 | VSS | VSS | VSS |
| W17 | VSS | VSS | VSS |
| W18 | VSS | VSS | VSS |
| W19 | VSS | VSS | VSS |
| W32 | VSS | VSS | VSS |
| Y13 | VSS | VSS | VSS |
| Y14 | VSS | VSS | VSS |
| Y15 | VSS | VSS | VSS |
| Y20 | VSS | VSS | VSS |
| Y21 | VSS | VSS | VSS |
| Y22 | VSS | VSS | VSS |
| AA13 | VSS | VSS | VSS |
| AA14 | VSS | VSS | VSS |

Pin Information (continued)

Table 28. 680-Pin PBGAM Pinout (continued)

| Pin | OR3L165B | OR3L225B | Function |
|------|----------|----------|----------|
| AA15 | VSS | VSS | VSS |
| AA20 | VSS | VSS | VSS |
| AA21 | VSS | VSS | VSS |
| AA22 | VSS | VSS | VSS |
| AB13 | VSS | VSS | VSS |
| AB14 | VSS | VSS | VSS |
| AB15 | VSS | VSS | VSS |
| AB20 | VSS | VSS | VSS |
| AB21 | VSS | VSS | VSS |
| AB22 | VSS | VSS | VSS |
| AC3 | VSS | VSS | VSS |
| AC32 | VSS | VSS | VSS |
| AG3 | VSS | VSS | VSS |
| AG32 | VSS | VSS | VSS |
| AL4 | VSS | VSS | VSS |
| AL31 | VSS | VSS | VSS |
| AM3 | VSS | VSS | VSS |
| AM8 | VSS | VSS | VSS |
| AM12 | VSS | VSS | VSS |
| AM16 | VSS | VSS | VSS |
| AM19 | VSS | VSS | VSS |
| AM23 | VSS | VSS | VSS |
| AM27 | VSS | VSS | VSS |
| AM32 | VSS | VSS | VSS |
| AN1 | VSS | VSS | VSS |
| AN2 | VSS | VSS | VSS |
| AN33 | VSS | VSS | VSS |
| AN34 | VSS | VSS | VSS |
| AP1 | VSS | VSS | VSS |
| AP2 | VSS | VSS | VSS |
| AP33 | VSS | VSS | VSS |
| AP34 | VSS | VSS | VSS |
| C5 | VDD2 | VDD2 | VDD2 |
| C30 | VDD2 | VDD2 | VDD2 |
| D5 | VDD2 | VDD2 | VDD2 |
| D30 | VDD2 | VDD2 | VDD2 |
| E3 | VDD2 | VDD2 | VDD2 |
| E4 | VDD2 | VDD2 | VDD2 |
| E5 | VDD2 | VDD2 | VDD2 |
| E6 | VDD2 | VDD2 | VDD2 |
| E29 | VDD2 | VDD2 | VDD2 |
| E30 | VDD2 | VDD2 | VDD2 |
| E31 | VDD2 | VDD2 | VDD2 |

Pin Information (continued)

Table 28. 680-Pin PBGAM Pinout (continued)

| Pin | OR3L165B | OR3L225B | Function |
|-----|----------|----------|----------|
| E32 | VDD2 | VDD2 | VDD2 |
| F5 | VDD2 | VDD2 | VDD2 |
| F30 | VDD2 | VDD2 | VDD2 |
| N16 | VDD2 | VDD2 | VDD2 |
| N17 | VDD2 | VDD2 | VDD2 |
| N18 | VDD2 | VDD2 | VDD2 |
| N19 | VDD2 | VDD2 | VDD2 |
| P16 | VDD2 | VDD2 | VDD2 |
| P17 | VDD2 | VDD2 | VDD2 |
| P18 | VDD2 | VDD2 | VDD2 |
| P19 | VDD2 | VDD2 | VDD2 |
| R16 | VDD2 | VDD2 | VDD2 |
| R17 | VDD2 | VDD2 | VDD2 |
| R18 | VDD2 | VDD2 | VDD2 |
| R19 | VDD2 | VDD2 | VDD2 |
| T13 | VDD2 | VDD2 | VDD2 |
| T14 | VDD2 | VDD2 | VDD2 |
| T15 | VDD2 | VDD2 | VDD2 |
| T20 | VDD2 | VDD2 | VDD2 |
| T21 | VDD2 | VDD2 | VDD2 |
| T22 | VDD2 | VDD2 | VDD2 |
| U13 | VDD2 | VDD2 | VDD2 |
| U14 | VDD2 | VDD2 | VDD2 |
| U15 | VDD2 | VDD2 | VDD2 |
| U20 | VDD2 | VDD2 | VDD2 |
| U21 | VDD2 | VDD2 | VDD2 |
| U22 | VDD2 | VDD2 | VDD2 |
| V13 | VDD2 | VDD2 | VDD2 |
| V14 | VDD2 | VDD2 | VDD2 |
| V15 | VDD2 | VDD2 | VDD2 |
| V20 | VDD2 | VDD2 | VDD2 |
| V21 | VDD2 | VDD2 | VDD2 |
| V22 | VDD2 | VDD2 | VDD2 |
| W13 | VDD2 | VDD2 | VDD2 |
| W14 | VDD2 | VDD2 | VDD2 |
| W15 | VDD2 | VDD2 | VDD2 |
| W20 | VDD2 | VDD2 | VDD2 |
| W21 | VDD2 | VDD2 | VDD2 |
| W22 | VDD2 | VDD2 | VDD2 |
| Y16 | VDD2 | VDD2 | VDD2 |
| Y17 | VDD2 | VDD2 | VDD2 |
| Y18 | VDD2 | VDD2 | VDD2 |
| Y19 | VDD2 | VDD2 | VDD2 |

Pin Information (continued)

Table 28. 680-Pin PBGAM Pinout (continued)

| Pin | OR3L165B | OR3L225B | Function |
|------|----------|----------|----------|
| AA16 | VDD2 | VDD2 | VDD2 |
| AA17 | VDD2 | VDD2 | VDD2 |
| AA18 | VDD2 | VDD2 | VDD2 |
| AA19 | VDD2 | VDD2 | VDD2 |
| AB16 | VDD2 | VDD2 | VDD2 |
| AB17 | VDD2 | VDD2 | VDD2 |
| AB18 | VDD2 | VDD2 | VDD2 |
| AB19 | VDD2 | VDD2 | VDD2 |
| AJ5 | VDD2 | VDD2 | VDD2 |
| AJ30 | VDD2 | VDD2 | VDD2 |
| AK3 | VDD2 | VDD2 | VDD2 |
| AK4 | VDD2 | VDD2 | VDD2 |
| AK5 | VDD2 | VDD2 | VDD2 |
| AK6 | VDD2 | VDD2 | VDD2 |
| AK29 | VDD2 | VDD2 | VDD2 |
| AK30 | VDD2 | VDD2 | VDD2 |
| AK31 | VDD2 | VDD2 | VDD2 |
| AK32 | VDD2 | VDD2 | VDD2 |
| AL5 | VDD2 | VDD2 | VDD2 |
| AL30 | VDD2 | VDD2 | VDD2 |
| AM5 | VDD2 | VDD2 | VDD2 |
| AM30 | VDD2 | VDD2 | VDD2 |
| A3 | VDD | VDD | VDD |
| A32 | VDD | VDD | VDD |
| B3 | VDD | VDD | VDD |
| B4 | VDD | VDD | VDD |
| B31 | VDD | VDD | VDD |
| B32 | VDD | VDD | VDD |
| C1 | VDD | VDD | VDD |
| C2 | VDD | VDD | VDD |
| C4 | VDD | VDD | VDD |
| C7 | VDD | VDD | VDD |
| C11 | VDD | VDD | VDD |
| C15 | VDD | VDD | VDD |
| C20 | VDD | VDD | VDD |
| C24 | VDD | VDD | VDD |
| C28 | VDD | VDD | VDD |
| C31 | VDD | VDD | VDD |
| C33 | VDD | VDD | VDD |
| C34 | VDD | VDD | VDD |
| D2 | VDD | VDD | VDD |
| D3 | VDD | VDD | VDD |
| D32 | VDD | VDD | VDD |

Pin Information (continued)

Table 28. 680-Pin PBGAM Pinout (continued)

| Pin | OR3L165B | OR3L225B | Function |
|------|----------|----------|----------|
| D33 | VDD | VDD | VDD |
| G3 | VDD | VDD | VDD |
| G32 | VDD | VDD | VDD |
| L3 | VDD | VDD | VDD |
| L32 | VDD | VDD | VDD |
| R3 | VDD | VDD | VDD |
| R32 | VDD | VDD | VDD |
| Y3 | VDD | VDD | VDD |
| Y32 | VDD | VDD | VDD |
| AD3 | VDD | VDD | VDD |
| AD32 | VDD | VDD | VDD |
| AH3 | VDD | VDD | VDD |
| AH32 | VDD | VDD | VDD |
| AL2 | VDD | VDD | VDD |
| AL3 | VDD | VDD | VDD |
| AL32 | VDD | VDD | VDD |
| AL33 | VDD | VDD | VDD |
| AM1 | VDD | VDD | VDD |
| AM2 | VDD | VDD | VDD |
| AM4 | VDD | VDD | VDD |
| AM7 | VDD | VDD | VDD |
| AM11 | VDD | VDD | VDD |
| AM15 | VDD | VDD | VDD |
| AM20 | VDD | VDD | VDD |
| AM24 | VDD | VDD | VDD |
| AM28 | VDD | VDD | VDD |
| AM31 | VDD | VDD | VDD |
| AM33 | VDD | VDD | VDD |
| AM34 | VDD | VDD | VDD |
| AN3 | VDD | VDD | VDD |
| AN4 | VDD | VDD | VDD |
| AN31 | VDD | VDD | VDD |
| AN32 | VDD | VDD | VDD |
| AP3 | VDD | VDD | VDD |
| AP32 | VDD | VDD | VDD |

Absolute Maximum Ratings

Stresses in excess of the absolute maximum ratings can cause permanent damage to the device. These are absolute stress ratings only. Functional operation of the device is not implied at these or any other conditions in excess of those given in the operations sections of this data sheet. Exposure to absolute maximum ratings for extended periods can adversely affect device reliability.

The ORCA Series FPGAs include circuitry designed to protect the chips from damaging substrate injection currents and to prevent accumulations of static charge. Nevertheless, conventional precautions should be observed during storage, handling, and use to avoid exposure to excessive electrical stress.

Table 29. Absolute Maximum Ratings

| Parameter | Symbol | Min | Max | Unit |
|---|------------------|------|-----------------------|------|
| Storage Temperature | T _{stg} | -65 | 150 | °C |
| I/O Supply Voltage with Respect to Ground | V _{DD} | — | <4.2 | V |
| Internal Supply Voltage | V _{DD2} | — | <3.2 | V |
| Input Signal with Respect to Ground | | | | |
| CMOS I/O | — | -0.5 | V _{DD} + 0.3 | V |
| 5 V tolerant I/O | — | -0.5 | 5.8 | V |
| Signal Applied to High-impedance Output | — | -0.5 | V _{DD} + 0.3 | V |
| Maximum Package Body Temperature | — | — | 220 | °C |
| Junction Temperature | T _J | -40 | 125 | °C |

Recommended Operating Conditions

Table 30. Recommended Operating Conditions

| Mode | OR3LxxxB | | |
|------------|-----------------------------|---------------------------------------|---|
| | Temperature Range (Ambient) | I/O Supply Voltage (V _{DD}) | Internal Supply Voltage (V _{DD2}) |
| Commercial | 0 °C to 70 °C | 3.0 V to 3.6 V | 2.5 V ± 5% |
| Industrial | -40 °C to +85 °C | 3.0 V to 3.6 V | 2.5 V ± 5% |

Electrical Characteristics

Table 31. Electrical Characteristics

OR3LxxxB Commercial: $V_{DD} = 3.0\text{ V to }3.6\text{ V}$, $V_{DD2} = 2.38\text{ V to }2.63\text{ V}$, $0\text{ }^{\circ}\text{C} < T_A < 70\text{ }^{\circ}\text{C}$; Industrial: $V_{DD} = 3.0\text{ V to }3.6\text{ V}$, $V_{DD2} = 2.38\text{ V to }2.63\text{ V}$, $-40\text{ }^{\circ}\text{C} < T_A < +85\text{ }^{\circ}\text{C}$.

| Parameter | Symbol | Test Conditions | OR3LxxxB | | Unit |
|--|------------|---|--------------|----------------|---------------|
| | | | Min | Max | |
| Input Voltage: High Low | V_{IH} | Input configured as CMOS (clamped to V_{DD}) | 50% V_{DD} | $V_{DD} + 0.5$ | V |
| | V_{IL} | | GND - 0.5 | 30% V_{DD} | V |
| Input Voltage: High Low | V_{IH} | Input configured as TTL (5 V tolerant) | 50% V_{DD} | 5.8 V | V |
| | V_{IL} | | GND - 0.5 | 30% V_{DD} | V |
| Output Voltage: High Low | V_{OH} | $V_{DD} = \text{min}$, $I_{OH} = 6\text{ mA or }3\text{ mA}$ | 2.4 | — | V |
| | V_{OL} | $V_{DD} = \text{min}$, $I_{OL} = 12\text{ mA or }6\text{ mA}$ | — | 0.4 | V |
| Input Leakage Current | I_L | $V_{DD} = \text{max}$, $V_{IN} = V_{SS}$ or V_{DD} | -10 | 10 | μA |
| Standby Current: OR3L165B OR3L225B | I_{DDSB} | $(T_A = 25\text{ }^{\circ}\text{C}$, $V_{DD} = 3.3\text{ V}$, $V_{DD2} = 2.5\text{ V}$) internal oscillator running, no output loads, inputs V_{DD} or GND | — | V_{DD2} | mA |
| | | | — | V_{DD} | |
| Standby Current: OR3L165B OR3L225B | I_{DDSB} | $(T_A = 25\text{ }^{\circ}\text{C}$, $V_{DD} = 3.3\text{ V}$, $V_{DD2} = 2.5\text{ V}$) internal oscillator stopped, no output loads, inputs V_{DD} or GND (after configuration) | — | 1.1 | mA |
| | | | — | 1.0 | |
| Powerup Current: OR3L165B OR3L225B | I_{pp} | Power supply current at approximately 1 V, within a recommended power supply ramp rate of 1 ms—200 ms | 0.4 | — | mA |
| | | | 0.8 | — | |
| Input Capacitance | C_{IN} | $T_A = 25\text{ }^{\circ}\text{C}$, $V_{DD} = 3.3\text{ V}$, $V_{DD2} = 2.5\text{ V}$ Test frequency = 1 MHz | — | 8 | pF |
| Output Capacitance | C_{OUT} | $T_A = 25\text{ }^{\circ}\text{C}$, $V_{DD} = 3.3\text{ V}$, $V_{DD2} = 2.5\text{ V}$ Test frequency = 1 MHz | — | 8 | pF |
| DONE Pull-up Resistor* | R_{DONE} | — | 100 | — | k Ω |
| M[3:0] Pull-up Resistors* | R_M | — | 100 | — | k Ω |
| I/O Pad Static Pull-up Current* | I_{PU} | $V_{DD} = 3.6\text{ V}$, $V_{IN} = V_{SS}$, $T_A = 0\text{ }^{\circ}\text{C}$ | 14.4 | 50.9 | μA |
| I/O Pad Static Pull-down Current | I_{PD} | $V_{DD} = 3.6\text{ V}$, $V_{IN} = V_{SS}$, $T_A = 0\text{ }^{\circ}\text{C}$ | 26 | 103 | μA |
| I/O Pad Pull-up Resistor* | R_{PU} | $V_{DD} = \text{all}$, $V_{IN} = V_{SS}$, $T_A = 0\text{ }^{\circ}\text{C}$ | 100 | — | k Ω |
| I/O Pad Pull-down Resistor | R_{PD} | $V_{DD} = \text{all}$, $V_{IN} = V_{SS}$, $T_A = 0\text{ }^{\circ}\text{C}$ | 50 | — | k Ω |

* On the Series 3L devices, the pull-up resistor will externally pull the pin to a level 1.0 V below V_{DD} .

Package Thermal Characteristics

There are four thermal parameters that are in common use: Θ_{JA} , ψ_{JC} , Θ_{JC} , and Θ_{JB} . It should be noted that all the parameters are affected, to varying degrees, by package design (including paddle size) and choice of materials, the amount of copper in the test board or system board, and system airflow.

Table 32 contains the currently available thermal specifications for Lattice's FPGA packages mounted on both JEDEC and non-JEDEC test boards. The thermal values for the newer package types correspond to those packages mounted on a JEDEC four-layer board. The values for the older packages, however, correspond to those packages mounted on a non-JEDEC, single-layer, sparse copper board (see Note 2). It should also be noted that the values for the older packages are considered conservative.

Θ_{JA}

This is the thermal resistance from junction to ambient (a.k.a. Θ -JA, R- Θ , etc.). It is defined by the following:

$$\Theta_{JA} = \frac{T_J - T_A}{Q}$$

where T_J is the junction temperature, T_A is the ambient air temperature, and Q is the chip power.

Experimentally, Θ_{JA} is determined when a special thermal test die is assembled into the package of interest, and the part is mounted on the thermal test board. The diodes on the test chip are separately calibrated in an oven. The package/board is placed either in a JEDEC natural convection box or in the wind tunnel, the latter for forced convection measurements. A controlled amount of power (Q) is dissipated in the test chip's heater resistor, the chip's temperature (T_J) is determined by the forward drop on the diodes, and the ambient temperature (T_A) is noted. Note that Θ_{JA} is expressed in units of $^{\circ}\text{C}/\text{watt}$.

ψ_{JC}

This JEDEC designated parameter correlates the junction temperature to the case temperature. It is generally used to infer the junction temperature while the device is operating in the system. It is not considered a true thermal resistance, and it is defined by the following:

$$\psi_{JC} = \frac{T_J - T_C}{Q}$$

where T_C is the case temperature at top dead center, T_J is the junction temperature, and Q is the chip power. During the Θ_{JA} measurements described above, besides the other parameters measured, an additional temperature reading, T_C , is made with a thermocouple attached at top-dead-center of the case. ψ_{JC} is also expressed in units of $^{\circ}\text{C}/\text{watt}$.

Θ_{JC}

This is the thermal resistance from junction to case. It is most often used when attaching a heat sink to the top of the package. It is defined by the following:

$$\Theta_{JC} = \frac{T_J - T_C}{Q}$$

The parameters in this equation have been defined above. However, the measurements are performed with the case of the part pressed against a water-cooled heat sink so as to draw most of the heat generated by the chip out the top of the package. It is this difference in the measurement process that differentiates Θ_{JC} from ψ_{JC} . Θ_{JC} is a true thermal resistance and is expressed in units of $^{\circ}\text{C}/\text{watt}$.

Θ_{JB}

This is the thermal resistance from junction to board (a.k.a. Θ -JB). It is defined by the following:

$$\Theta_{JB} = \frac{T_J - T_B}{Q}$$

where T_B is the temperature of the board adjacent to a lead measured with a thermocouple. The other parameters on the right-hand side have been defined above. This is considered a true thermal resistance, and the measurement is made with a water-cooled heat sink pressed against the board so as to draw most of the heat out of the leads. Note that Θ_{JB} is expressed in units of $^{\circ}\text{C}/\text{watt}$, and that this parameter and the way it is measured is still in JEDEC committee.

Package Thermal Characteristics (continued)

FPGA Maximum Junction Temperature

Once the power dissipated by the FPGA has been determined (see the Estimating Power Dissipation section), the maximum junction temperature of the FPGA can be found. This is needed to determine if speed derating of the device from the 85 °C junction temperature used in all of the delay tables is needed. Using the maximum ambient temperature, T_{Amax} , and the power dissipated by the device, Q (expressed in °C), the maximum junction temperature is approximated by the following:

$$T_{Jmax} = T_{Amax} + (Q \times \Theta_{JA})$$

Table 32 lists the plastic package thermal characteristics for the *ORCA* Series FPGAs.

Table 32. Plastic Package Thermal Characteristics for the *ORCA* Series¹

| Package | Θ_{JA} (°C/W) | | | $T_A = 70\text{ °C max}$ $T_J = 125\text{ °C max}$ at 0 fpm (W) |
|------------------------------|----------------------|---------|---------|---|
| | 0 fpm | 200 fpm | 500 fpm | |
| 208-Pin SQFP2 ¹ | 12.8 | 10.3 | 9.1 | 4.3 |
| 240-Pin SQFP2 ¹ | 13.0 | 10.0 | 9.0 | 4.2 |
| 352-Pin PBGA ^{1, 2} | 19.0 | 16.0 | 15.0 | 2.9 |
| 352-Pin PBGA ^{1, 3} | 25.5 | 22.0 | 20.5 | 2.1 |
| 432-Pin EBGA ¹ | 11.0 | 8.5 | 7.5 | 5.0 |
| 680-Pin PBGAM1 | 14.5 | TBD | TBD | 3.8 |

1. Mounted on 4-layer JEDEC standard test board with two power/ground planes.
2. With thermal balls connected to board ground plane.
3. Without thermal balls connected to board ground plane.

Package Coplanarity

The coplanarity limits of the ORCA Series 3 packages are as follows.

Table 33. Package Coplanarity

| Package Type | Coplanarity Limit (mils) |
|--------------|--------------------------|
| EBGA | 8.0 |
| PBGA | 8.0 |
| SQFP2 | 3.15 |
| PBGAM1 | 8.0 |

Package Parasitics

The electrical performance of an IC package, such as signal quality and noise sensitivity, is directly affected by the package parasitics. Table 34 lists eight parasitics associated with the ORCA packages. These parasitics represent the contributions of all components of a

package, which include the bond wires, all internal package routing, and the external leads.

Four inductances in nH are listed: LSW and LSL, the self-inductance of the lead; and LMW and LML, the mutual inductance to the nearest neighbor lead. These parameters are important in determining ground bounce noise and inductive crosstalk noise. Three capacitances in pF are listed: CM, the mutual capacitance of the lead to the nearest neighbor lead; and C1 and C2, the total capacitance of the lead to all other leads (all other leads are assumed to be grounded). These parameters are important in determining capacitive crosstalk and the capacitive loading effect of the lead. The lead resistance value, RW, is in mΩ.

The parasitic values in Table 34 are for the circuit model of bond wire and package lead parasitics. If the mutual capacitance value is not used in the designer's model, then the value listed as mutual capacitance should be added to each of the C1 and C2 capacitors.

Table 34. Package Parasitics

| Package Type | LSW | LMW | RW | C1 | C2 | CM | LSL | LML |
|----------------|-----|-----|-----|-----|-----|-----|---------|-------|
| 208-Pin SQFP2 | 4 | 2 | 200 | 1 | 1 | 1 | 6—9 | 4—6 |
| 240-Pin SQFP2 | 4 | 2 | 200 | 1 | 1 | 1 | 7—11 | 4—7 |
| 352-Pin PBGA | 5 | 2 | 220 | 1.5 | 1.5 | 1.5 | 7—12 | 3—6 |
| 432-Pin EBGA | 4 | 1.5 | 500 | 1 | 1 | 0.3 | 3—5.5 | 0.5—1 |
| 680-Pin PBGAM1 | 3.8 | 1.3 | 250 | 1 | 1 | 0.3 | 2.8—5.0 | 0.5—1 |

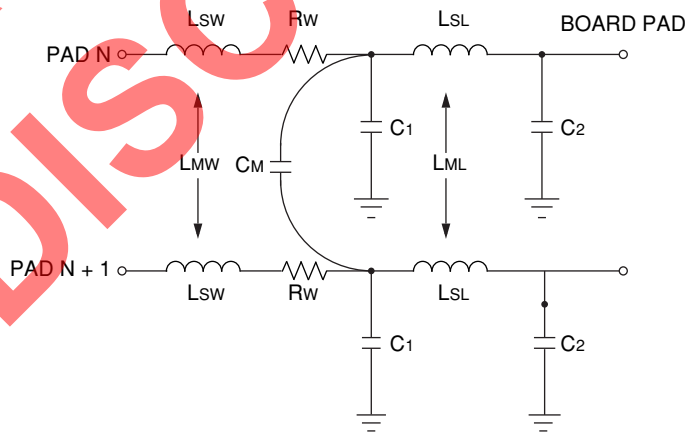

5-3862(F).a

Figure 12. Package Parasitics

Package Outline Diagrams

Terms and Definitions

| | |
|------------------------------------|--|
| Basic Size (BSC): | The basic size of a dimension is the size from which the limits for that dimension are derived by the application of the allowance and the tolerance. |
| Design Size: | The design size of a dimension is the actual size of the design, including an allowance for fit and tolerance. |
| Typical (TYP): | When specified after a dimension, this indicates the repeated design size if a tolerance is specified or repeated basic size if a tolerance is not specified. |
| Reference (REF): | The reference dimension is an untoleranced dimension used for informational purposes only. It is a repeated dimension or one that can be derived from other values in the drawing. |
| Minimum (MIN) or Maximum (MAX): | Indicates the minimum or maximum allowable size of a dimension. |

ALL DEVICES
DISCONTINUED

Package Outline Diagrams (continued)

208-Pin SQFP2

Dimensions are in millimeters.

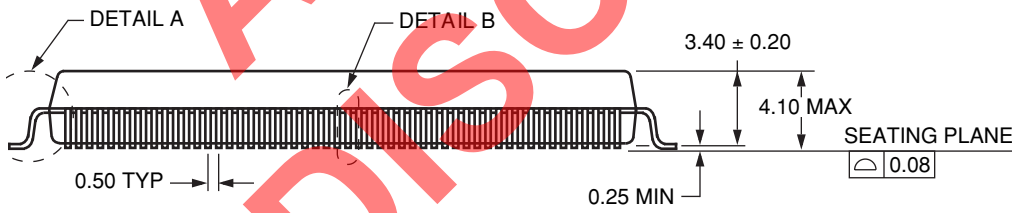

5-3828(F)

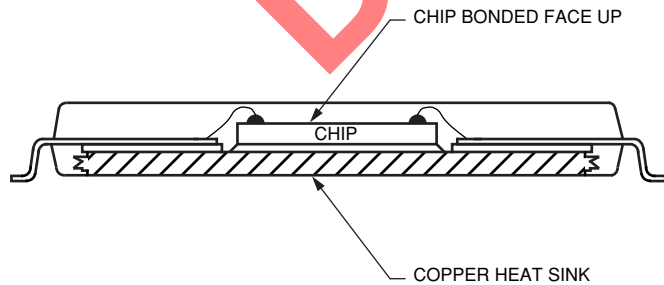

DETAIL C (SQFP2 CHIP-UP)

5-4946(F)

Package Outline Diagrams (continued)

240-Pin SQFP2

Dimensions are in millimeters.

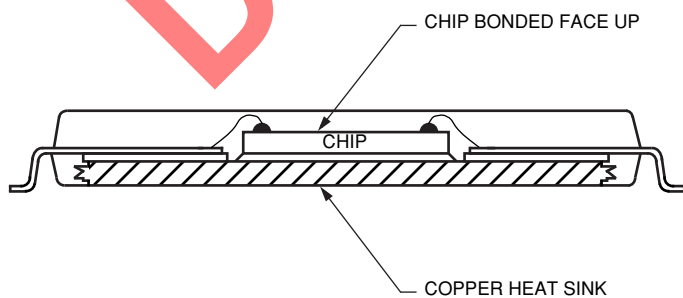
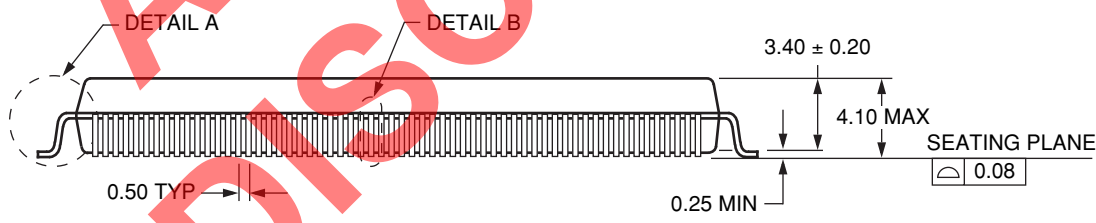

DETAIL C (SQFP2 CHIP-UP)

5-3825 (F).a

5-4946(F)

Package Outline Diagrams (continued)

352-Pin PBGA

Dimensions are in millimeters.

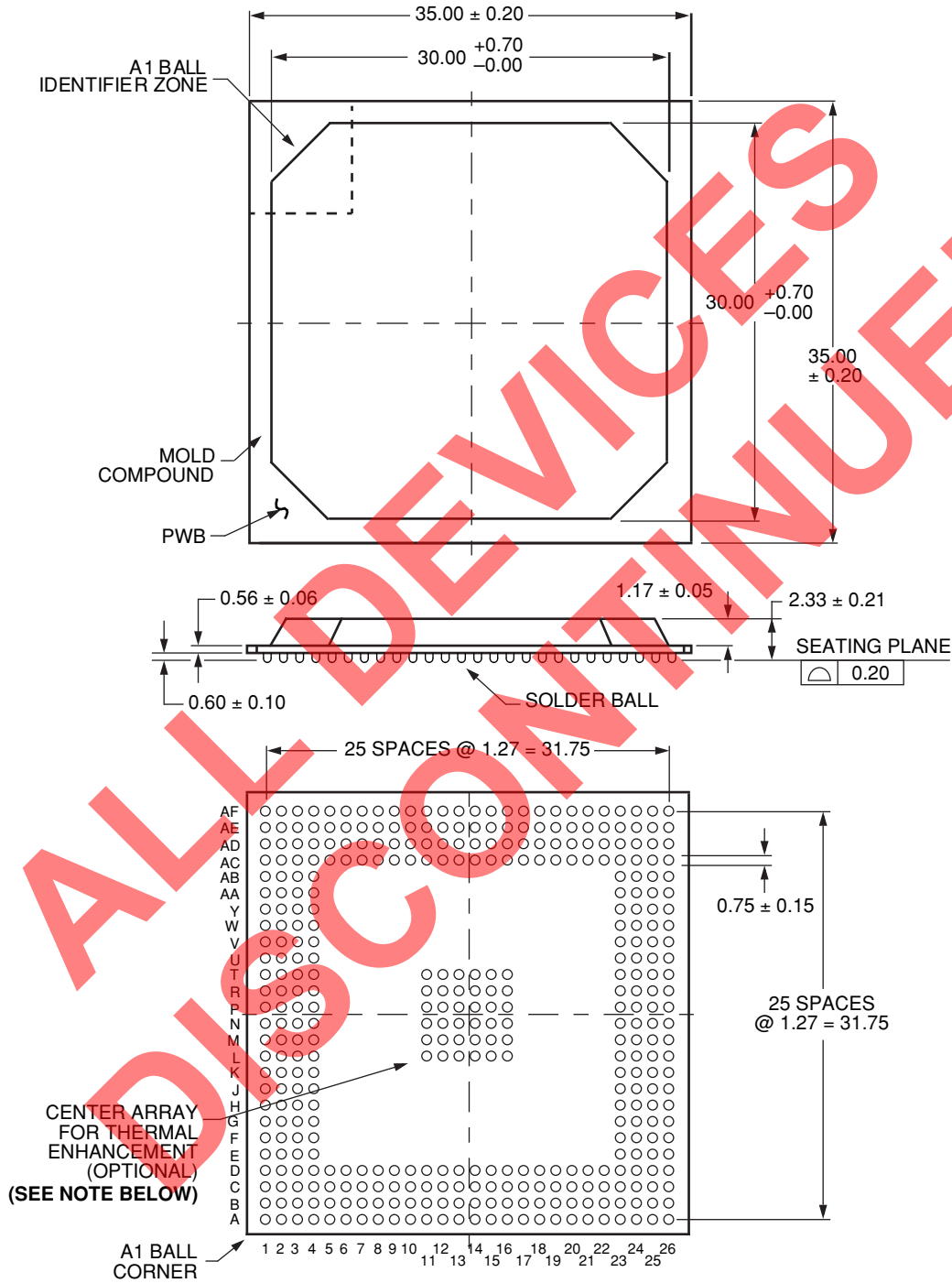

5-4407(F)

Note: Although the 36 thermal enhancement balls are stated as an option, they are standard on the 352 FPGA package.

Package Outline Diagrams (continued)

432-Pin EPGA

Dimensions are in millimeters.

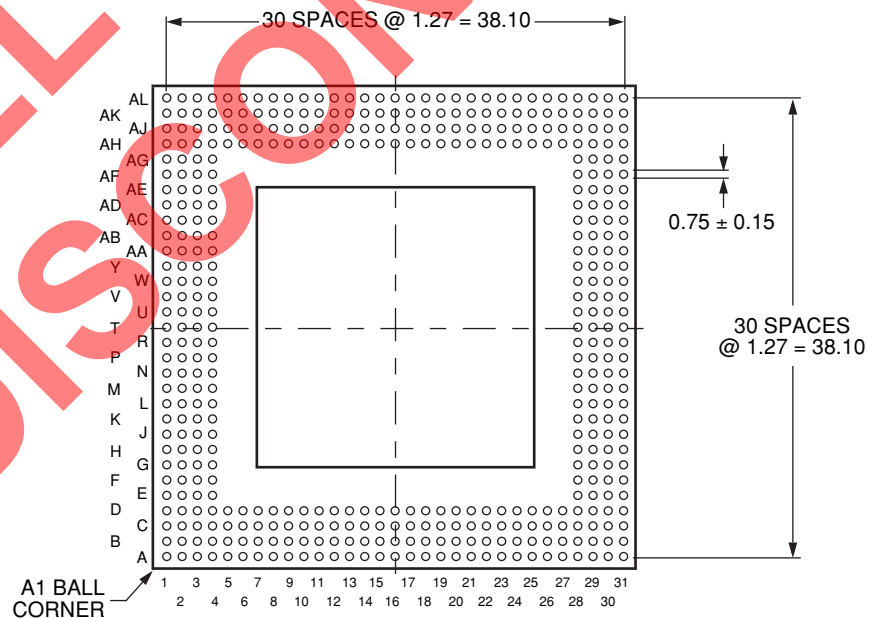

5-4409(F)

Package Outline Diagrams (continued)

680-Pin PBGAM

Dimensions are in millimeters.



5-4406(F)

Ordering Information



Table 35. Voltage Options

| Device | Voltage |
|----------|--------------------------|
| OR3LxxxB | 2.5 V internal/3.3 V I/O |

Table 36. Ordering Information

| Device Family | Part Number | Speed Grade | Package Type | Pin/Ball Count | Grade | Packing Designator |
|---------------|--------------------------------|-------------|--------------|----------------|-------|--------------------|
| OR3L165B | OR3L165B8PS208-DB ¹ | 8 | SQFP2 | 208 | C | DB |
| | OR3L165B8PS240-DB ¹ | 8 | SQFP2 | 240 | C | DB |
| | OR3L165B8BA352-DB | 8 | PBGA | 352 | C | DB |
| | OR3L165B8BC432-DB | 8 | EBGA | 432 | C | DB |
| | OR3L165B8BM680-DB | 8 | PBGAM | 680 | C | DB |
| | OR3L165B7PS208-DB ¹ | 7 | SQFP2 | 208 | C | DB |
| | OR3L165B7PS240-DB ¹ | 7 | SQFP2 | 240 | C | DB |
| | OR3L165B7BA352-DB | 7 | PBGA | 352 | C | DB |
| | OR3L165B7BC432-DB | 7 | EBGA | 432 | C | DB |
| | OR3L165B7BM680-DB | 7 | PBGAM | 680 | C | DB |
| OR3L225B | OR3L225B8BC432-DB ¹ | 8 | EBGA | 432 | C | DB |
| | OR3L225B8BM680-DB ¹ | 8 | PBGAM | 680 | C | DB |
| | OR3L225B7BC432-DB ¹ | 7 | EBGA | 432 | C | DB |
| | OR3L225B7BM680-DB ¹ | 7 | PBGAM | 680 | C | DB |

1. Discontinued per PCN #06-07. Contact Rochester Electronics for available inventory.

Industrial

| Device Family | Part Number | Speed Grade | Package Type | Pin/Ball Count | Grade | Packing Designator |
|---------------|---------------------------------|-------------|--------------|----------------|-------|--------------------|
| OR3L165B | OR3L165B7PS208I-DB ¹ | 7 | SQFP2 | 208 | I | DB |
| | OR3L165B7PS240I-DB ¹ | 7 | SQFP2 | 240 | I | DB |
| | OR3L165B7BA352I-DB | 7 | PBGA | 352 | I | DB |
| | OR3L165B7BC432I-DB | 7 | EBGA | 432 | I | DB |
| | OR3L165B7BM680I-DB | 7 | PBGAM | 680 | I | DB |
| OR3L225B | OR3L225B7BC432I-DB ¹ | 7 | EBGA | 432 | I | DB |
| | OR3L225B7BM680I-DB ¹ | 7 | PBGAM | 680 | I | DB |

1. Discontinued per PCN #06-07. Contact Rochester Electronics for available inventory

ALL DEVICES DISCONTINUED

www.latticesemi.com

Copyright © 2002 Lattice Semiconductor
All Rights Reserved

March 2002
DA99-011FPGA (Replaces DA99-008FPGA and must accompany DS99-087FPGA)





Компания «ЭлектроПласт» предлагает заключение долгосрочных отношений при поставках импортных электронных компонентов на взаимовыгодных условиях!

Наши преимущества:

- Оперативные поставки широкого спектра электронных компонентов отечественного и импортного производства напрямую от производителей и с крупнейших мировых складов;
- Поставка более 17-ти миллионов наименований электронных компонентов;
- Поставка сложных, дефицитных, либо снятых с производства позиций;
- Оперативные сроки поставки под заказ (от 5 рабочих дней);
- Экспресс доставка в любую точку России;
- Техническая поддержка проекта, помощь в подборе аналогов, поставка прототипов;
- Система менеджмента качества сертифицирована по Международному стандарту ISO 9001;
- Лицензия ФСБ на осуществление работ с использованием сведений, составляющих государственную тайну;
- Поставка специализированных компонентов (Xilinx, Altera, Analog Devices, Intersil, Interpoint, Microsemi, Aeroflex, Peregrine, Syfer, Eurofarad, Texas Instrument, Miteq, Cobham, E2V, MA-COM, Hittite, Mini-Circuits, General Dynamics и др.);

Помимо этого, одним из направлений компании «ЭлектроПласт» является направление «Источники питания». Мы предлагаем Вам помощь Конструкторского отдела:

- Подбор оптимального решения, техническое обоснование при выборе компонента;
- Подбор аналогов;
- Консультации по применению компонента;
- Поставка образцов и прототипов;
- Техническая поддержка проекта;
- Защита от снятия компонента с производства.



Как с нами связаться

Телефон: 8 (812) 309 58 32 (многоканальный)

Факс: 8 (812) 320-02-42

Электронная почта: org@eplast1.ru

Адрес: 198099, г. Санкт-Петербург, ул. Калинина, дом 2, корпус 4, литера А.