

Powerpole® & Multipole Power Connectors

10 amps up to 700 amps



APP
Anderson Power Products®

Anderson Power Products

APP's philosophy is to provide products and services within the trading markets of our customers. We currently serve our worldwide customer base from customer support and manufacturing facilities in Sterling, MA, U.S.A., Fermoy, Ireland for European customers, as well as three Asia Pacific facilities: Shenzhen, China, Shatin Hong Kong and Taichung City 407, Taiwan (R.O.C.).

Today, as a result of innovative design and development, APP has evolved into a valued supplier for a wide variety of markets including Back-up Power, Telecom/Datacom and the Material Handling Industries.

APP has established a reputation for high quality products, on-time deliveries, and excellent customer service. As a result of modern manufacturing techniques and rigorous quality control measures, APP assures customers receive the quality products they deserve.

As a global company dedicated to best environmental practice, APP has taken steps to meet the RoHS directive for virtually all of their products. APP believes that general compliance with the RoHS directive is not enough and that the RoHS status for individual APP products must be readily accessible to customers twenty-four hours a day, seven days a week. The APP website search system allows customers to enter a part number and determine a product's compliance status to the RoHS directive.

APP looks forward to the challenges posed by the new technologies of the future and will continue its century long tradition of design excellence and superior customer support to meet customers' needs.



Anderson Power Products® may revise terms and conditions from time to time without notice. APP maintains this catalog as a service to its customers. The entire content (photographs and text) is ©copyrighted 2007 and may not be distributed, modified, reused, or otherwise used, except as provided herein, without the express written permission of APP. You may use the content only for your personal, non-commercial use.

APP will use reasonable efforts to include accurate and up-to-date content in the catalog. All product information contained in the catalog including illustrations, specifications, and dimensions, are believed to be reliable as of the date of publishing, but is subject to change without notice. APP makes no warranty or representation as to its accuracy. Content in the catalog may contain technical inaccuracies, typographical errors and may be changed or updated without notice. Current sales drawings and specifications are available upon request.

Neither APP nor any party involved in creating, producing, or delivering this catalog shall be liable for any direct, incidental, consequential, indirect, or punitive damages arising out of your use of this catalog or any errors or omissions in its content. All product names, whether or not appearing in large print or with the trademark symbol, including, but not limited to A, A in circle, Anderson Power Products, Powerpole, Powerclaw, SB, SBE, SBO, SBS, SBX are trademarks of APP, its affiliates, related companies, licensors, and/or joint venture partners. The use or misuse of these trademarks, or any other content of this catalog, except as permitted herein, is expressly prohibited and may be in violation of intellectual property laws, which shall be aggressively enforced.

HEADQUARTERS: 13 Pratts Junction Road, P.O. Box 579, Sterling, MA 01564 T:978-422-3600 F:978-422-3700

EUROPE: Rathealy Road, Fermoy Co. Cork, Ireland T:353-(0)25-32277 F:353-(0)25-32296

ASIA/PACIFIC: IDEAL Anderson Asia Pacific Ltd., Unit 922-928 Topsail Plaza, 11 On Sum Street, Shatin N.T., Hong Kong T:852-2636-0836 F:852-2635-9036

CHINA: IDEAL Anderson Technologies (Shenzhen) Ltd., Block A8 Tantou W. Ind. Par, Songgang Baoan District, Shenzhen, P.R. China 51810 T: 86-755-2768-2118 F: 86-755-2768-2218

TAIWAN: IDEAL Anderson Asia Pacific Ltd., Taiwan Branch, 4F-2, No.116, Dadun 20th St., Situn District, Taichung City 407, Taiwan (R.O.C.) T: 886-4-2310-6451 F:886-4-2310-6460

www.andersonpower.com

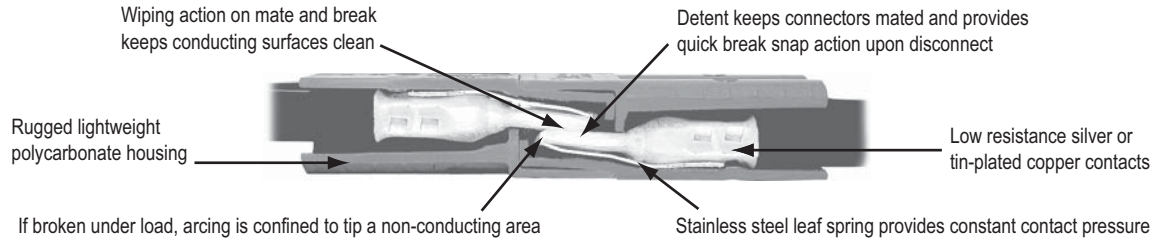

Where Do Contacts Contact?

Although electrical contacts appear to have a large surface area, only a small portion of that area actually touches the mating part, because any metal surface — no matter how finely polished or ground — is never perfectly flat or smooth.

Mating Surface

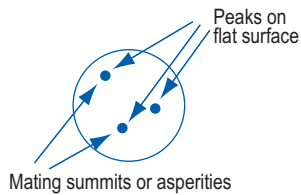

The butt contact conducts current via three or less summits or high peaks (asperities).

Mating Cross Section



The cylindrical contact, although it appears to have a large, ample area, actually conducts current through no more than three lines of contact in this example.

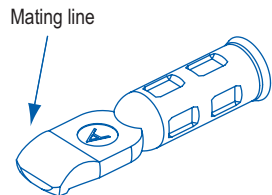

The sliding contact, when spring loaded, conducts current through an entire line of contact.

What Makes A Good Connector?

The termination can make the difference between good and poor connector continuity. This hypothetical example of “good” and “poor” continuity shows how power loss can seriously impair the efficiency of an EV. Important are two points of resistance:

1. R_c , the central contact resistance.
2. R_w the resistance at two terminations.

A typical sliding connector carries 175A, but when the termination resistance R_w , rises because of faulty design or assembly, total resistance rises, too. (See table). Using the basic relationship for DC power,

$$P = (I \times R) (I) = I^2R$$

The “good” conductor dissipates, or loses,
 $P = (175)^2 (0.00004) = 1.225W$

The “poor” conductor loses,
 $P = (175)^2 (0.00202) = 61.8W$

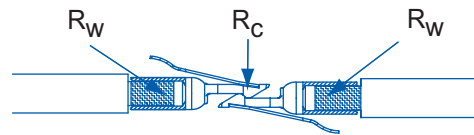

Good vs. Poor Connection

| Typical Joint | R_w | R_c | R_w | R_{total} |
|---------------|----------|----------|----------|-------------|
| Good | 0.000010 | 0.000020 | 0.000010 | 0.000040 |
| Poor | 0.001000 | 0.000020 | 0.001000 | 0.002020 |

Anderson Power Products®, an ISO 9001:2000 certified company, is a world leader in the design and manufacture of quick-disconnect power connectors. Our connectors are rated from 10 amps to 700 amps and from 150 to 600 volts, AC/DC and comply with major worldwide specifications. With over one hundred years of power connection and device experience, we provide off-the-shelf and custom solutions for OEMs.

Contents

| | | | |
|-------------------------------------|----|-------------------------------|----|
| Anderson Power Products | 1 | SBS Series..... | 49 |
| Genderless Connector..... | 2 | SBS50 | 50 |
| Index | 3 | SB Series..... | 53 |
| Powerpole Pin & Socket Series..... | 5 | SB50 | 54 |
| PP10 Pin & Sockets | 6 | SB120 | 56 |
| PP30 Pin & Sockets | 8 | SB175 | 58 |
| Powerpole Single Pole Series | 11 | SB350 | 60 |
| PP15 | 12 | SBE Series..... | 63 |
| PP30 | 14 | SBE80 | 64 |
| PP45 | 16 | SBE160 | 66 |
| PP15/45 Finger Proof | 18 | SBE320 | 68 |
| PP75 | 20 | SBE700 | 70 |
| PP75 Locking | 22 | SBO Series..... | 73 |
| PP120 | 24 | SBO60 | 74 |
| PP180 | 26 | SBX Series..... | 77 |
| Powerpole PCB Series..... | 29 | SBX175 | 78 |
| 25 amp PP15/45 | 30 | SBX350 | 80 |
| 45 amp High Power | 32 | Application Notes | 82 |
| 55 amp Powerclaw | 34 | Interpretation of Charts..... | 83 |
| Power Pak Series..... | 39 | Wire Conversion Chart..... | 84 |
| Powerpole Pak Modular | 40 | Glossary of Terminology..... | 85 |
| Blindmate Power Pak..... | 42 | Part Number Index..... | 87 |
| Bus Bar Series..... | 45 | | |
| Powerpole & Multipole Bus Bar | 46 | | |

Note:

- (1) For patent / trademark information, please see www.andersonpower.com.
- (2) Use APP recommended crimp tooling. Crimping by other means may disturb contact position in the housing and / or produce high resistance in the mated connection, which can cause melting and other hazardous conditions. Please see www.andersonpower.com, tooling section, for the recommendations, changes / additions and tips on connector crimping / soldering or preventative maintenance.
- (3)  All products in this catalog are RoHS compliant. For RoHS compliant information on individual part numbers, please see www.andersonpower.com for the RoHS lookup index tool.

©Copyright 2007 Anderson Power Products®

The data herein are solely for your information and not offered, or to be construed, as a warranty or contractual responsibility.

HEADQUARTERS: 13 Pratts Junction Road, P.O. Box 579, Sterling, MA 01564 T:978-422-3600 F:978-422-3700

EUROPE: Rathealy Road, Fermoy Co. Cork, Ireland T:353-(0)25-32277 F:353-(0)25-32296

ASIA/PACIFIC: IDEAL Anderson Asia Pacific Ltd., Unit 922-928 Topsail Plaza, 11 On Sum Street, Shatin N.T., Hong Kong T:852-2636-0836 F:852-2635-9036

CHINA: IDEAL Anderson Technologies (Shenzhen) Ltd., Block A8 Tantou W. Ind. Par, Songgang Baoan District, Shenzhen, P.R. China 51810 T: 86-755-2768-2118 F: 86-755-2768-2218

TAIWAN: IDEAL Anderson Asia Pacific Ltd., Taiwan Branch, 4F-2, No.116, Dadun 20th St., Situn District, Taichung City 407, Taiwan (R.O.C.) T: 886-4-2310-6451 F:886-4-2310-6460

www.andersonpower.com



Connector Notes

For customer drawings, assembly instructions and individual data sheets, please visit www.andersonpower.com

HEADQUARTERS: 13 Pratts Junction Road, P.O. Box 579, Sterling, MA 01564 T:978-422-3600 F:978-422-3700

EUROPE: Rathealy Road, Fermoy Co. Cork, Ireland T:353-(0)25-32277 F:353-(0)25-32296

ASIA/PACIFIC: IDEAL Anderson Asia Pacific Ltd., Unit 922-928 Topsail Plaza, 11 On Sum Street, Shatin N.T., Hong Kong T:852-2636-0836 F:852-2635-9036

CHINA: IDEAL Anderson Technologies (Shenzhen) Ltd., Block A8 Tantou W. Ind. Par, Songgang Baoan District, Shenzhen, P.R. China 51810 T: 86-755-2768-2118 F: 86-755-2768-2218

TAIWAN: IDEAL Anderson Asia Pacific Ltd., Taiwan Branch, 4F.-2, No.116, Dadun 20th St., Situn District, Taichung City 407, Taiwan (R.O.C.) T: 886-4-2310-6451 F:886-4-2310-6460

www.andersonpower.com

FEATURES

- Make-first/Break-last connection**
Provides safety and system integrity
- Green housing**
Indicates ground terminal
- Molded-in dovetails**
Can be assembled into "keyed" configurations to preclude misconnections
- Silver plated contacts**
Offers greatest longevity when using high power, elevated temperature applications
- UL94 V-0 housing material**
Provides security in knowledge the connector chosen meets strict UL flammability ratings

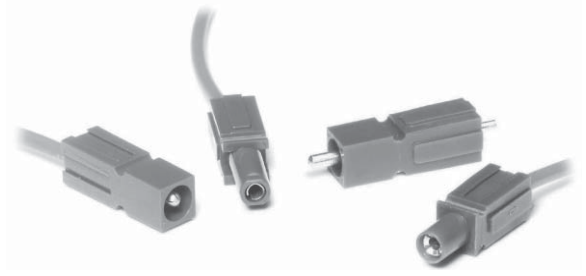

PRODUCT RANGE

| | |
|---|---------------|
| UL Current Rating (Amperes)* | 10* to 30**** |
| UL Voltage Ratings (Volts)** | 600* |
| Contact Barrel Wire Size (AWG) | #10 to 16 |
| (mm ²) | 5.3 to 1.3 |
| Maximum Wire Insulation Diameter (inches) | .175 to 0.137 |
| (mm) | 4.45 to 3.48 |
| AVG Contact Resistance* (micro-ohms) | 600 to 2200 |
| Insulation Withstanding | 2200 |
| Test Voltage (Volts AC/DC) | |
| Contact Retention Force (lbf) | 25 |
| Life | |
| a. No load (Contact/Disconnect Cycles) | To 10,000 |
| Avg. Connection/Disconnect (lbf) | 3 to 5 |
| Operating Temperature Range °C*** | -20° to 105° |
| °F | -4° to 221° |
| Flammability Rating of Housing Material | UL94 V-0 |



* UL Rated for 65°C largest wire or cable size

** Both AC & DC Voltage

*** Contact factory for higher temperature rated connectors

**** Based on 10 AWG

PRODUCT INFORMATION

Invented by Anderson Power Products®, the innovative modular Powerpole® connectors provide cost-effective reliability, design flexibility and safety for your products' manufacture, installation and maintenance.

Powerpole® pin & socket series connector, designed as ground terminal are for make-first/break-last connections. The dovetail feature allows you to interlock multiple housings into vertical and horizontal configurations, providing you with unique variations that are specific to each individual project requirement. The housings are interchangeable, genderless interconnects. Insert contacts into housings and plug together for a clever, simple and low-cost solution to power interconnection.

Powerpole® modular pin and socket connectors are available in 10 and 30 amp ratings for use through 600 Volts continuous, AC or DC operation. There are Powerpoles for many applications and wire sizes, #10 (5.3mm) to #16AWG (1.3mm). Contacts are available in reeled and loose piece designs to support all production needs from very high volumes to engineering prototype and low-volume customized products.

Markets: Electronics, Telecommunications, Office Panels, UPS Systems, Electric Vehicles, Industrial & Much More.



CSA Certified
File No. LR25154



File No. E26226

All Data Subject To Change Without Notice

HEADQUARTERS: 13 Pratts Junction Road, P.O. Box 579, Sterling, MA 01564 T:978-422-3600 F:978-422-3700

EUROPE: Rathealy Road, Fermoy Co. Cork, Ireland T:353-(0)25-32277 F:353-(0)25-32296

ASIA/PACIFIC: IDEAL Anderson Asia Pacific Ltd., Unit 922-928 Topsail Plaza, 11 On Sum Street, Shatin N.T., Hong Kong T:852-2636-0836 F:852-2635-9036

CHINA: IDEAL Anderson Technologies (Shenzhen) Ltd., Block A8 Tantou W. Ind. Par, Songgang Baoan District, Shenzhen, PR. China 51810 T: 86-755-2768-2118 F: 86-755-2768-2218

TAIWAN: IDEAL Anderson Asia Pacific Ltd., Taiwan Branch, 4F.-2, No.116, Dadun 20th St., Situn District, Taichung City 407, Taiwan (R.O.C.) T: 886-4-2310-6451 F:886-4-2310-6460

www.andersonpower.com

Powerpole® connectors provide cost-effective reliability, design flexibility and safety for your products' manufacture, installation and maintenance.

The housings are modular. They provide 600 Volts continuous, AC or DC operation. Wire sizes range from #14 to #16 AWG (2.1 to 1.3 mm²). Contacts are available in reeled and loose piece designs to support all production needs from engineering prototype, low volume and high volumes products.

FEATURES

- **Make-first/Break-last connection**

Provides safety and system integrity

- **Green housing**

Visual indication of ground terminal

- **Molded-in dovetails**

Can be assembled with standard Powerpole PP15, Powerpole PP30 and Powerpole PP45 connectors to make pre-grounded multipole configurations



PRODUCT SPECIFICATIONS

| Connector Model | PP10 P & S | Connector Model | PP10 P & S |
|--|------------|---|--------------|
| UL Current Rating (Amperes)* | 10* | No load (Contact/Disconnect Cycles) | To 250 |
| UL Voltage Ratings (Volts)** | 600* | Avg. Connection/Disconnect (lbf) | 5 |
| Contact Barrel Wire Size (AWG) | #14 to #16 | Operating Temperature Range °C*** | -20° to 105° |
| (mm ²) | 2.1 to 1.3 | °F | -4° to 221° |
| Maximum Wire Insulation Diameter (inches) | 0.137 | Flammability Rating of Housing Material | UL94 V-0 |
| (mm) | 3.48 | | |
| AVG Contact Resistance* (micro-ohms) | 2200 | | |
| Insulation Withstanding Test Voltage (Volts AC/DC) | 2200 | | |
| Contact Retention Force (lbf) | 25 | | |



* UL Rated for 65°C largest wire or cable size
** Both AC & DC Voltage
*** Contact factory for higher temperature rated connectors

ORDERING INFORMATION

Housing & 10 amp Contact

| Part Number | Housing Color | Wire | |
|-------------|---------------|-------|---------|
| | | AWG | sq. mm |
| 1200G1 | Socket, Green | 14/16 | 2.1/1.3 |
| 1201G1 | Pin, Green | 14/16 | 2.1/1.3 |

Housings Only

| Part Number | Description |
|-------------|-----------------------|
| 1204G1 | Green housing, socket |
| 1205G1 | Green housing, pin |

Tooling

| Part Number | Description |
|-------------|-----------------------------------|
| 1309G1 | Hand tool, #14 to #16 |
| 260G3 | Applicator only (110V & 220V) |
| 280G2 | Applicator and press (110V, 60Hz) |
| 250G1 | Press only (110V, 60Hz) |
| 250G2 | Press only (220V, 50Hz) |

10 amp Contacts

| Part Number | Description | Wire | |
|-------------|--------------------|-------|---------|
| | | AWG | sq. mm |
| 1202G1 | Socket, Individual | 14/16 | 2.1/1.3 |
| 264G1 | Socket, Reel | 14/16 | 2.1/1.3 |
| 1203G1 | Pin, Individual | 14/16 | 2.1/1.3 |
| 263G1 | Pin, Reel | 14/16 | 2.1/1.3 |

Note: For additional colors please contact customer service

HEADQUARTERS: 13 Pratts Junction Road, P.O. Box 579, Sterling, MA 01564 T:978-422-3600 F:978-422-3700

EUROPE: Rathealy Road, Fermoy Co. Cork, Ireland T:353-(0)25-32277 F:353-(0)25-32296

ASIA/PACIFIC: IDEAL Anderson Asia Pacific Ltd., Unit 922-928 Topsail Plaza, 11 On Sum Street, Shatin N.T., Hong Kong T:852-2636-0836 F:852-2635-9036

CHINA: IDEAL Anderson Technologies (Shenzhen) Ltd., Block A8 Tantou W. Ind. Par, Songgang Baoan District, Shenzhen, PR. China 51810 T: 86-755-2768-2118 F: 86-755-2768-2218

TAIWAN: IDEAL Anderson Asia Pacific Ltd., Taiwan Branch, 4F.-2, No.116, Dadun 20th St., Situn District, Taichung City 407, Taiwan (R.O.C.) T: 886-4-2310-6451 F:886-4-2310-6460

www.andersonpower.com

DIMENSIONS

Housings

| Series | -A- | | -B- | | -C- | | -D- | |
|-------------|-----|------|-----|------|------|-------|------|------|
| | mm | in. | mm | in. | mm | in. | mm | in. |
| PP10 Pin | 7.9 | 0.31 | 7.9 | 0.31 | 24.5 | 0.97 | 41.3 | 1.63 |
| PP10 Socket | 7.9 | 0.31 | 7.9 | 0.31 | 27.5 | 1.081 | 41.3 | 1.63 |

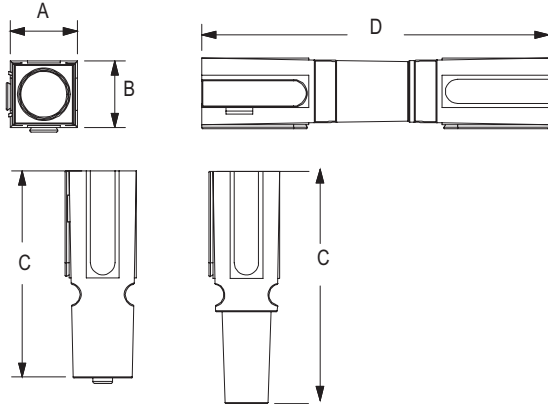

Contacts

| Series | -A- | | -B- | |
|-------------|------|------|-----|------------|
| | mm | in. | mm | in. |
| PP10 Pin | 22.4 | 0.88 | 2.4 | 0.093 - OD |
| PP10 Socket | 22.4 | 0.88 | 2.3 | 0.089 - ID |

Socket Contact

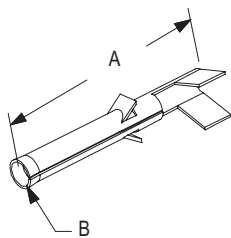

Pin Contact

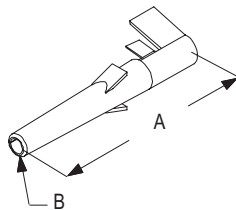

TEMPERATURE RISE CHARTS

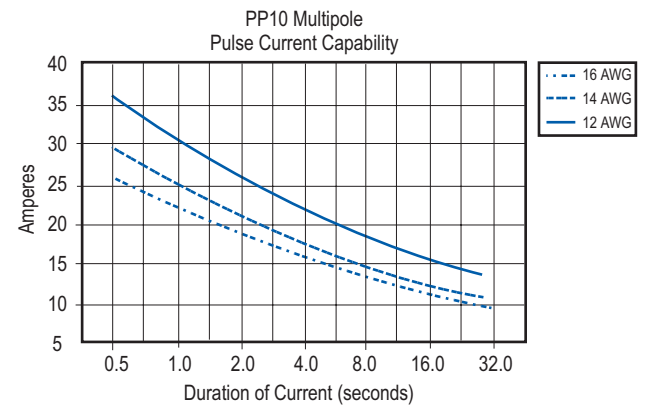
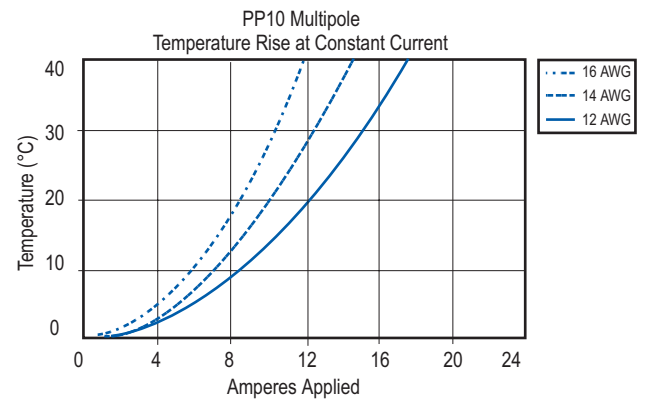
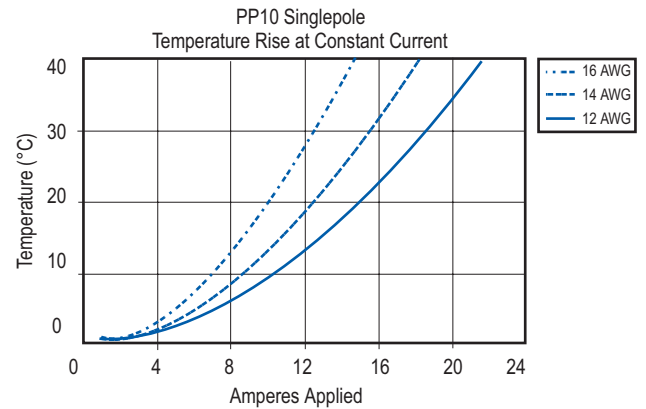

Powerpole® pin & socket series connector, designed as ground terminal are for make-first/break-last connections.

The dovetail feature allows you to interlock multiple housings into vertical and horizontal configurations, providing you with unique variations that are specific to each individual project requirement.

Powerpole® connectors provide 600 Volts continuous, AC or DC operation. This series accommodates #10 AWG (5.3 mm²).

FEATURES

- **Make-first/Break-last connection**
Provides safety and system integrity
- **Green housing**
Indicates ground terminal
- **Molded-in dovetails**
Can be assembled into "keyed" configurations to preclude misconnections



PRODUCT SPECIFICATIONS

| Connector Model | PP30 P & S | Connector Model | PP30 P & S |
|--|------------|---|--------------|
| UL Current Rating (Amperes)* | 30**** | No load (Contact/Disconnect Cycles) | To 250 |
| UL Voltage Ratings (Volts)** | 600* | Avg. Connection/Disconnect (lbf) | 3 |
| Contact Barrel Wire Size (AWG) | #10 | Operating Temperature Range °C*** | -20° to 105° |
| (mm ²) | 5.3 | °F | -4° to 221° |
| Maximum Wire Insulation Diameter (inches) | 0.175 | Flammability Rating of Housing Material | UL94 V-0 |
| (mm) | 4.45 | | |
| AVG Contact Resistance* (micro-ohms) | 600 | | |
| Insulation Withstanding Test Voltage (Volts AC/DC) | 2200 | | |
| Contact Retention Force (lbf) | 25 | | |



* UL Rated for 65°C largest wire or cable size

** Both AC & DC Voltage

*** Contact factory for higher temperature rated connectors

**** Based on 10 AWG

ORDERING INFORMATION

30 amp Ground Socket Connectors

| Part Number | Description | Wire AWG | mm |
|-------------|---------------------------|----------|-----|
| PP30MF-S10T | Make First, Socket Tin | #10 | 3.3 |
| PP30MF-S10S | Make First, Socket Silver | #10 | 3.3 |

30 amp Ground Pin Connectors

| Part Number | Description | Wire AWG | mm |
|-------------|---------------------------|----------|-----|
| PP30MF-P10T | Make First, Pin Tin | #10 | 3.3 |
| PP30MF-P10S | Make First, Pin Silver | #10 | 3.3 |
| PP30MF-PPCT | Make First, Pin PC Tin | NA | NA |
| PP30MF-PPCS | Make First, Pin PC Silver | NA | NA |

Ground Pin Contacts

| Part Number | Description | Dia. |
|-------------|---------------------------------|------|
| 1230G1 | Individual, Pin for wire Tin | .134 |
| 1231G1 | Individual, Pin for wire Silver | .134 |
| 1234G1 | Pin, PCB Tin | N/A |
| 1235G1 | Pin, PCB Silver | N/A |

Ground Socket Contacts

| Part Number | Description | Dia. |
|-------------|------------------------------------|------|
| 1232G1 | Individual, Socket for wire Tin | .134 |
| 1233G1 | Individual, Socket for wire Silver | .134 |

Pin & Socket Housing Only

| Part Number | Description |
|-------------|-----------------------|
| PP30GND-P | Pin housing, green |
| PP30GND-S | Socket housing, green |

Pin & Socket Contacts For Use With Superflex Wire

| Part Number | Description | Wire AWG | mm |
|-------------|----------------|----------|----|
| 1226G1 | Pin Contact | #10 | 6 |
| 1228G1 | Socket Contact | #10 | 6 |

Tooling

| Part Number | Description |
|-------------|----------------|
| 1396G1 | Hand Tool |
| 1387G1 | Pneumatic Tool |
| 1388G8 | - Die #10 |
| 1389G8 | - Locator #10 |

Note: For additional colors please contact customer service

HEADQUARTERS: 13 Pratts Junction Road, P.O. Box 579, Sterling, MA 01564 T:978-422-3600 F:978-422-3700

EUROPE: Rathealy Road, Fermoy Co. Cork, Ireland T:353-(0)25-32277 F:353-(0)25-32296

ASIA/PACIFIC: IDEAL Anderson Asia Pacific Ltd., Unit 922-928 Topsail Plaza, 11 On Sum Street, Shatin N.T., Hong Kong T:852-2636-0836 F:852-2635-9036

CHINA: IDEAL Anderson Technologies (Shenzhen) Ltd., Block A8 Tantou W. Ind. Par, Songgang Baoan District, Shenzhen, PR. China 51810 T: 86-755-2768-2118 F: 86-755-2768-2218

TAIWAN: IDEAL Anderson Asia Pacific Ltd., Taiwan Branch, 4F-2, No.116, Dadun 20th St., Situn District, Taichung City 407, Taiwan (R.O.C.) T: 886-4-2310-6451 F:886-4-2310-6460

www.andersonpower.com

DIMENSIONS

Housings

| Series | -A- | | -B- | | -C- | | -D- | |
|-------------|-----|------|-----|------|------|------|------|------|
| | mm | in. | mm | in. | mm | in. | mm | in. |
| PP30 Pin | 7.9 | 0.32 | 7.9 | 0.32 | 26.6 | 0.97 | 41.2 | 1.62 |
| PP30 Socket | 7.9 | 0.32 | 7.9 | 0.32 | 26.6 | 0.97 | 41.2 | 1.62 |

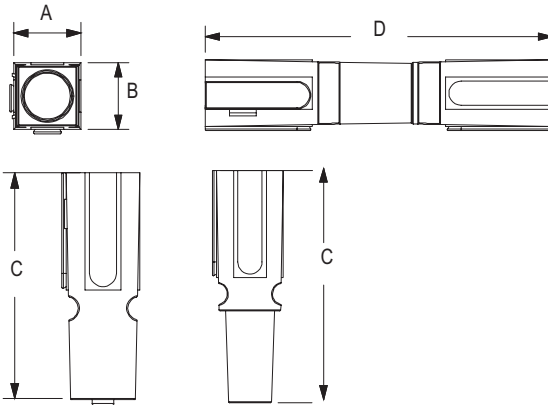

TEMPERATURE RISE CHART

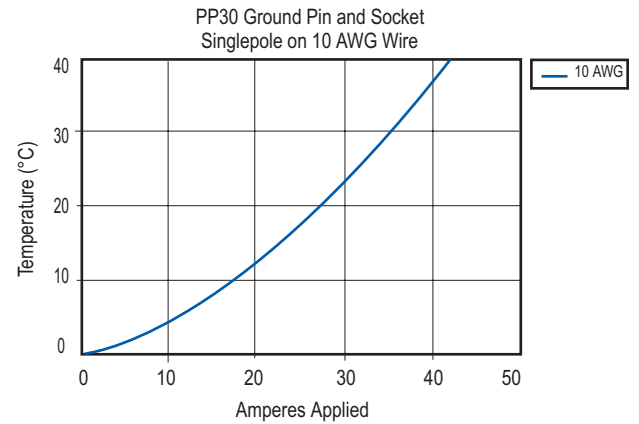

Contacts

| Series | -A- | | -B- | | -C- | |
|-------------|-----|------|------|------|------|------|
| | mm | in. | mm | in. | mm | in. |
| PP30 Pin | 5.1 | 0.20 | 29.2 | 1.15 | 2.29 | 0.09 |
| PP30 Socket | 5.1 | 0.20 | 24.9 | 0.98 | N/A | N/A |

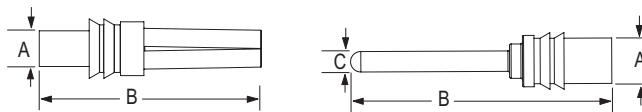



Connector Notes

For customer drawings, assembly instructions and individual data sheets, please visit www.andersonpower.com.

HEADQUARTERS: 13 Pratts Junction Road, P.O. Box 579, Sterling, MA 01564 T:978-422-3600 F:978-422-3700

EUROPE: Rathealy Road, Fermoy Co. Cork, Ireland T:353-(0)25-32277 F:353-(0)25-32296

ASIA/PACIFIC: IDEAL Anderson Asia Pacific Ltd., Unit 922-928 Topsail Plaza, 11 On Sum Street, Shatin N.T., Hong Kong T:852-2636-0836 F:852-2635-9036

CHINA: IDEAL Anderson Technologies (Shenzhen) Ltd., Block A8 Tantou W. Ind. Par, Songgang Baoan District, Shenzhen, P.R. China 51810 T: 86-755-2768-2118 F: 86-755-2768-2218

TAIWAN: IDEAL Anderson Asia Pacific Ltd., Taiwan Branch, 4F.-2, No.116, Dadun 20th St., Situn District, Taichung City 407, Taiwan (R.O.C.) T: 886-4-2310-6451 F:886-4-2310-6460

www.andersonpower.com

FEATURES

- **Flat wiping contact system**

Allows for minimal contact resistance at high current, wiping action cleans contact surface during connection/disconnection

- **Interchangeable genderless design**

Makes assembly quick and easy and reduces number of parts stocked

- **Silver plated contacts**

Offers greatest longevity when using high power, elevated temperature applications

- **Colored modular housings**

Provides visual identification of proper mating connector

- **Polarized housings**

Prevents damage to connectors from being mated incorrectly

- **Molded-in dovetails**

Secures individual connectors together

- **Crimp PCB or Bus bar contact terminals**

Offers design flexibility for your manufacturing and maintenance requirements

- **Wide product range - from 15 amps through 180 amps**

15, 30, 45, 75, 120 and 180 product ratings, allows versatility to choose product best suited to design requirements

- **UL94 V-0 housing material**

Provides security in knowledge that the connector chosen meets strict UL flammability ratings

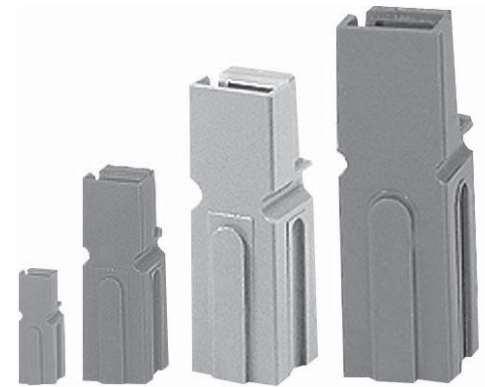

PRODUCT RANGE

| | |
|--|---------------|
| UL Current Rating (Amperes)* | 15* to 180* |
| UL Voltage Ratings (Volts)** | 600* |
| Contact Barrel Wire Size (AWG) | #20 to 1/0 |
| (mm ²) | .5 to 53.5 |
| Maximum Wire Insulation Diameter (inches) | .175 to 0.900 |
| (mm) | 4.45 to 22.86 |
| AVG Contact Resistance* (micro-ohms) | 578 to 100 |
| Insulation Withstanding | 2200 |
| Test Voltage (Volts AC/DC) | |
| Contact Retention Force (lbf) | 25 to 170 |
| Life | |
| a. No load (Contact/Disconnect Cycles) | To 10,000 |
| b. Under Load (Hot Plug 250 cycles @ 120V) | 15A to 75A |
| Avg. Connection/Disconnect (lbf) | 3 to 20 |
| Operating Temperature Range °C*** | -20° to 105° |
| °F | -4° to 221° |
| Flammability Rating of Housing Material | UL94 V-0 |



* UL Rated for 65°C largest wire or cable size

** Both AC & DC Voltage

*** Contact factory for higher temperature rated connectors

PRODUCT INFORMATION

Invented by Anderson Power Products®, the innovative modular Powerpole® connectors provide cost-effective reliability, design flexibility and safety for your products' manufacture, installation and maintenance.

The housings are interchangeable, genderless interconnects. Insert contacts into housings and plug together for a clever, simple and low-cost solution to power interconnection. Low-detent contacts are also offered for low insertion/withdrawal force applications.

Powerpole® modular connectors are available in 15, 30, 45, 75, 120 and 180 amp ratings for use through 600 Volts continuous, AC or DC operation. There are Powerpoles for many applications and wire sizes, #20 (.5mm) to 1/0 AWG (53.5mm). Contacts are available in reeled and loose piece designs to support all production needs from very high volumes to engineering prototype and low-volume customized products. Powerpoles are stackable and color-coded for easy customization into multipole blocks with or without mechanical keys and make first - break last contacts.

Markets: Electronics, Telecommunications, Office Panels, UPS Systems, Electric Vehicles, Industrial & Much More.



File No. LR25154



File No. E26226

All Data Subject To Change Without Notice

HEADQUARTERS: 13 Pratts Junction Road, P.O. Box 579, Sterling, MA 01564 T:978-422-3600 F:978-422-3700

EUROPE: Rathealy Road, Fermoy Co. Cork, Ireland T:353-(0)25-32277 F:353-(0)25-32296

ASIA/PACIFIC: IDEAL Anderson Asia Pacific Ltd., Unit 922-928 Topsail Plaza, 11 On Sum Street, Shatin N.T., Hong Kong T:852-2636-0836 F:852-2635-9036

CHINA: IDEAL Anderson Technologies (Shenzhen) Ltd., Block A8 Tantou W. Ind. Par, Songgang Baoan District, Shenzhen, P.R. China 51810 T: 86-755-2768-2118 F: 86-755-2768-2218

TAIWAN: IDEAL Anderson Asia Pacific Ltd., Taiwan Branch, 4F.-2, No.116, Dadun 20th St., Situn District, Taichung City 407, Taiwan (R.O.C.) T: 886-4-2310-6451 F:886-4-2310-6460

www.andersonpower.com

Powerpole® connectors provide cost-effective reliability, design flexibility and safety for your products' manufacture, installation and maintenance.

The housings are modular and genderless. Powerpole® connectors provide 600 Volts continuous, AC or DC operation. Wire sizes range from #16 to #20 AWG (1.3 to .5 mm²). Contacts are available in reeled and loose piece designs to support all production needs from engineering prototype , low volume and high volumes products.

FEATURES

- Flat wiping contact system**
Minimal contact resistance at high current, wiping action cleans contact surface during connection/disconnection
- Colored modular housings**
Provides visual identification of proper mating connector
- Molded-in dovetails**
Secures individual connectors into "keyed" assemblies which prevents misconnection with similar configurations

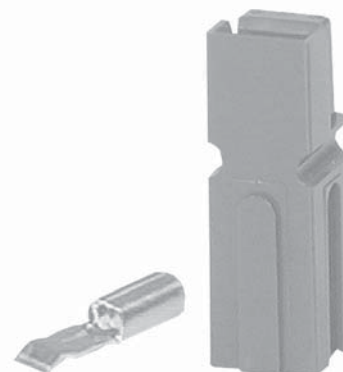

PRODUCT SPECIFICATIONS

| Connector Model | PP15 | Connector Model | PP15 |
|--|------------|--|-----------------------------------|
| UL Current Rating (Amperes)* | 15* | Life | |
| UL Voltage Ratings (Volts)** | 600* | a. No load (Contact/Disconnect Cycles) | To 10,000 |
| Contact Barrel Wire Size (AWG) | #16 to #20 | b. Under Load (Hot Plug 250 cycles @ 120V) | 15A |
| (mm ²) | 1.3 to .5 | Avg. Connection/Disconnect (lbf) | 3 - low detent 5 - high detent |
| Maximum Wire Insulation Diameter (inches) | 0.175 | Operating Temperature Range °C*** | -20° to 105° |
| (mm) | 4.45 | °F | -4° to 221° |
| AVG Contact Resistance* (micro-ohms) | 875 | Flammability Rating of Housing Material | UL94 V-0 |
| Insulation Withstanding Test Voltage (Volts AC/DC) | 2200 | | |
| Contact Retention Force (lbf) | 25 | | |



* UL Rated for 65°C largest wire or cable size
 ** Both AC & DC Voltage
 *** Contact factory for higher temperature rated connectors

ORDERING INFORMATION

Housing & 15 amp Contact

| Part Number | Housing Color | Wire AWG | Wire sq. mm |
|-------------|---------------|----------|-------------|
| 1395 | Red | 16/20 | 1.3/.52 |
| 1395G1 | Black | 16/20 | 1.3/.52 |
| 1395G2 | White | 16/20 | 1.3/.52 |
| 1395G3 | Green | 16/20 | 1.3/.52 |
| 1395G4 | Blue | 16/20 | 1.3/.52 |
| 1395G5 | Yellow | 16/20 | 1.3/.52 |
| 1395G6 | Orange | 16/20 | 1.3/.52 |
| 1395G7 | Gray | 16/20 | 1.3/.52 |
| 1395G8 | Brown | 16/20 | 1.3/.52 |
| 1395G9 | Pink | 16/20 | 1.3/.52 |
| 1395G10 | Purple | 16/20 | 1.3/.52 |

15 amp Contacts*

| Part Number | Description | Wire AWG | Wire sq. mm |
|-------------|----------------------|----------|-------------|
| 1332 | Individual - LD | 16/20 | 1.3/.52 |
| 262G1 | Reel - LD | 16/20 | 1.3/.52 |
| 269G2 | Reel - HD | 16/20 | 1.3/.52 |
| 269G2-LPBK | Individual - HD | 16/20 | 1.3/.52 |
| 200G2L | Superflex, reel - LD | 16/20 | 1.3/.52 |
| 201G2H | Superflex, reel - LD | 16/20 | 1.3/.52 |

Housings Only

| Part Number | Description |
|-------------|----------------|
| 1327 | Red housing |
| 1327G5 | Green housing |
| 1327G6 | Black housing |
| 1327G7 | White housing |
| 1327G8 | Blue housing |
| 1327G16 | Yellow housing |

housings continued

| Part Number | Description |
|-------------|----------------|
| 1327G17 | Orange housing |
| 1327G18 | Gray housing |
| 1327G21 | Brown housing |
| 1327G22 | Pink housing |
| 1327G23 | Purple housing |

Accessories

| Part Number | Description |
|-------------|------------------------|
| 1441G1 | Female splash boot |
| 1442G1 | Male splash boot |
| 110G21 | Blok lok, 2 pole |
| 110G12 | Blok lok, 4 pole |
| 1399G9 | Red mounting wing |
| 1399G8 | Blue mounting wing |
| 110G68 | PP15/45 retention clip |

* LD - low detent or HD - high detent

Note: For additional colors please contact customer service

HEADQUARTERS: 13 Pratts Junction Road, P.O. Box 579, Sterling, MA 01564 T:978-422-3600 F:978-422-3700

EUROPE: Rathealy Road, Fermoy Co. Cork, Ireland T:353-(0)25-32277 F:353-(0)25-32296

ASIA/PACIFIC: IDEAL Anderson Asia Pacific Ltd., Unit 922-928 Topsail Plaza, 11 On Sum Street, Shatin N.T., Hong Kong T:852-2636-0836 F:852-2635-9036

CHINA: IDEAL Anderson Technologies (Shenzhen) Ltd., Block A8 Tantou W. Ind. Par, Songgang Baoan District, Shenzhen, P.R. China 51810 T: 86-755-2768-2118 F: 86-755-2768-2218

TAIWAN: IDEAL Anderson Asia Pacific Ltd., Taiwan Branch, 4F-2, No.116, Dadun 20th St., Situn District, Taichung City 407, Taiwan (R.O.C.) T: 886-4-2310-6451 F:886-4-2310-6460

www.andersonpower.com

ORDERING INFORMATION

accessories continued

| Part Number | Description |
|-------------|--|
| 1399G1 | Red short spacer with end hole |
| 1399G2 | Red long spacer |
| 1399G6 | Red short spacer without hole |
| 1462G1 | 2 & 4 pole mounting clamp set |
| 1462G2 | 3 & 6 pole mounting clamp set |
| 1462G3 | 4 & 8 pole mounting clamp set |
| 110G16 | Retaining pins, 1 high block of connectors |
| 110G17 | Retaining pins, 2 high block of connectors |

Tooling

| Part Number | Description |
|-------------|-----------------------------------|
| 111038G2 | Contact insertion/extraction tool |
| 1309G2 | Hand tool #12 to #20 |
| 1309G5 | Hand tool for p/n 200G2L & 201G2H |
| 260G1 | Applicator only (110V & 220V) |
| 280G1 | Applicator and press (110V, 60Hz) |
| 260G14* | Applicator only (110V & 220V) |
| 260G15* | Applicator only (110V & 220V) |
| 260G18** | Applicator only (110V & 220V) |
| 250G1 | Press only (110V, 60Hz) |
| 280G4 | Applicator and press (220V, 50Hz) |
| 250G2 | Press only (220V, 50Hz) |

* Denotes mini-style applicator for use with existing "K" or "T" press
 ** Denotes mini-style applicator for use with existing "K" or "T" and "G" press

DIMENSIONS

Housing

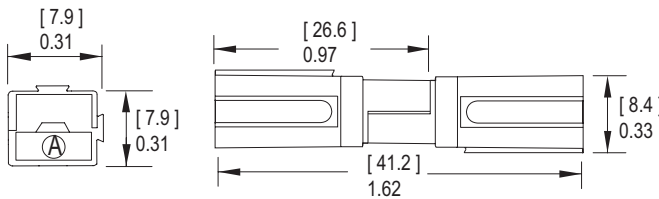

Contacts

| Part Number | -A- | | -B- | | -C- | | -D- | | -E- | |
|-------------|------|------|-----|------|-----|------|-----|------|-----|------|
| | mm | in. | mm | in. | mm | in. | mm | in. | mm | in. |
| 1332 | 16.3 | 0.64 | 7.8 | 0.31 | 3.1 | 0.12 | 1.8 | 0.07 | 3.6 | 0.14 |
| 262G1 | 17.2 | 0.68 | 6.4 | 0.25 | 4.1 | 0.16 | N/A | | 3.6 | 0.14 |
| 269G2 | 17.2 | 0.68 | 6.4 | 0.25 | 4.1 | 0.16 | N/A | | 3.6 | 0.14 |
| 269G2-LPBK | 17.2 | 0.68 | 6.4 | 0.25 | 4.1 | 0.16 | N/A | | 3.6 | 0.14 |
| 200G2L | 17.3 | 0.68 | 6.4 | 0.25 | 4.1 | 0.16 | N/A | | 3.6 | 0.14 |
| 201G2H | 17.3 | 0.68 | 6.4 | 0.25 | 4.1 | 0.16 | N/A | | 3.6 | 0.14 |

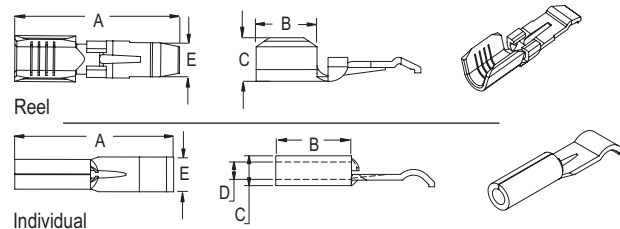

File No. LR25154 File No. E26226 All Data Subject To Change Without Notice

Note: For additional colors please contact customer service

TEMPERATURE RISE CHARTS

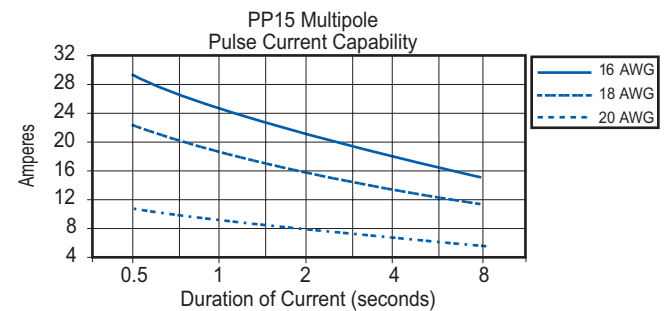
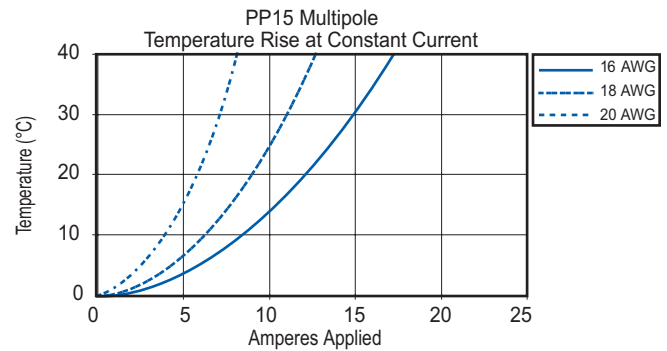
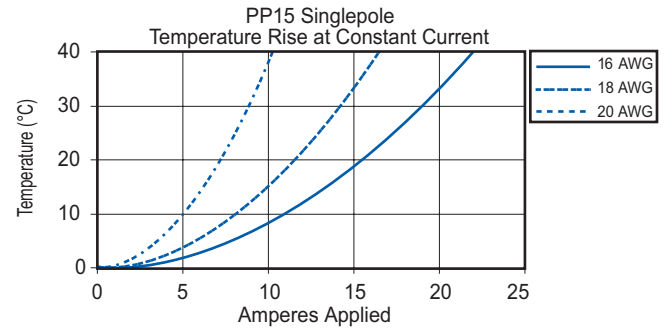

Mounting Clamps

| Part Number | -A- | | -B- | | -C- | | -D- | | Number of Poles |
|-------------|------|------|------|------|------|------|-----|------|-----------------|
| | mm | in. | mm | in. | mm | in. | mm | in. | |
| 1462G1 | 23.9 | 0.94 | 26.9 | 1.06 | 17.3 | 0.68 | 4.0 | 0.16 | (2 Pole) |
| 1462G1 | 23.9 | 0.94 | 35.0 | 1.38 | 25.4 | 1.00 | 4.0 | 0.16 | (4 Pole) |
| 1462G2 | 31.7 | 1.25 | 26.9 | 1.06 | 17.3 | 0.68 | 4.0 | 0.16 | (3 Pole) |
| 1462G2 | 31.7 | 1.25 | 35.0 | 1.38 | 25.4 | 1.00 | 4.0 | 0.16 | (6 Pole) |
| 1462G3 | 39.6 | 1.56 | 26.9 | 1.06 | 17.3 | 0.68 | 4.0 | 0.16 | (4 Pole) |
| 1462G3 | 39.6 | 1.56 | 35.0 | 1.38 | 25.4 | 1.00 | 4.0 | 0.16 | (8 Pole) |

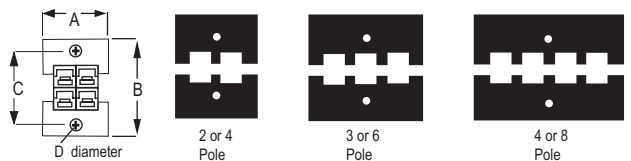

HEADQUARTERS: 13 Pratts Junction Road, P.O. Box 579, Sterling, MA 01564 T:978-422-3600 F:978-422-3700

EUROPE: Rathealy Road, Fermoy Co. Cork, Ireland T:353-(0)25-32277 F:353-(0)25-32296

ASIA/PACIFIC: IDEAL Anderson Asia Pacific Ltd., Unit 922-928 Topsail Plaza, 11 On Sum Street, Shatin N.T., Hong Kong T:852-2636-0836 F:852-2635-9036

CHINA: IDEAL Anderson Technologies (Shenzhen) Ltd., Block A8 Tantou W. Ind. Par, Songgang Baoan District, Shenzhen, PR. China 51810 T: 86-755-2768-2118 F: 86-755-2768-2218

TAIWAN: IDEAL Anderson Asia Pacific Ltd., Taiwan Branch, 4F.-2, No.116, Dadun 20th St., Situn District, Taichung City 407, Taiwan (R.O.C.) T: 886-4-2310-6451 F:886-4-2310-6460

Powerpole® connectors provide cost-effective reliability, design flexibility and safety for your products' manufacture, installation and maintenance.

The housings are modular and genderless. Powerpole® connectors provide 600 Volts continuous, AC or DC operation. Wire sizes range from #12 to #16 AWG (3.3 to 1.3 mm²). Contacts are available in reeled and loose piece designs to support all production needs from engineering prototype, low volume and high volumes products.

FEATURES

- **Flat wiping contact system**

Minimal contact resistance at high current, wiping action cleans contact surface during connection/disconnection

- **Colored modular housings**

Provides visual identification of proper mating connector

- **Molded-in dovetails**

Secures individual connectors into "keyed" assemblies which prevents misconnection with similar configurations

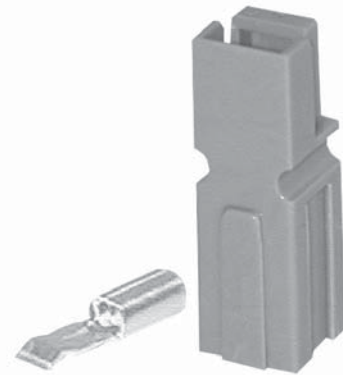

PRODUCT SPECIFICATIONS

| Connector Model | PP30 | Connector Model | PP30 |
|--|------------|--|-----------------------------------|
| UL Current Rating (Amperes)* | 30* | Life | |
| UL Voltage Ratings (Volts)** | 600* | a. No load (Contact/Disconnect Cycles) | To 10,000 |
| Contact Barrel Wire Size (AWG) | #12 to #16 | b. Under Load (Hot Plug 250 cycles @ 120V) | 30A |
| (mm ²) | 3.3 to 1.3 | Avg. Connection/Disconnect (lbf) | 3 - low detent 5 - high detent |
| Maximum Wire Insulation Diameter (inches) | 0.175 | Operating Temperature Range °C*** | -20° to 105° |
| (mm) | 4.45 | °F | -4° to 221° |
| AVG Contact Resistance* (micro-ohms) | 600 | Flammability Rating of Housing Material | UL94 V-0 |
| Insulation Withstanding Test Voltage (Volts AC/DC) | 2200 | | |
| Contact Retention Force (lbf) | 25 | | |



* UL Rated for 65°C largest wire or cable size

** Both AC & DC Voltage

*** Contact factory for higher temperature rated connectors

ORDERING INFORMATION

Housing & 30 amp Contact

| Part Number | Housing Color | Wire AWG | Wire sq. mm |
|-------------|---------------|----------|-------------|
| 1330 | Red | 12/16 | 3.3/1.3 |
| 1330G2 | Green | 12/16 | 3.3/1.3 |
| 1330G4 | Black | 12/16 | 3.3/1.3 |
| 1330G5 | White | 12/16 | 3.3/1.3 |
| 1330G11 | Yellow | 12/16 | 3.3/1.3 |
| 1330G12 | Blue | 12/16 | 3.3/1.3 |
| 1330G13 | Orange | 12/16 | 3.3/1.3 |
| 1330G14 | Gray | 12/16 | 3.3/1.3 |
| 1330G15 | Brown | 12/16 | 3.3/1.3 |
| 1330G16 | Pink | 12/16 | 3.3/1.3 |
| 1330G17 | Purple | 12/16 | 3.3/1.3 |

30 amp Contacts*

| Part Number | Description | Wire AWG | Wire sq. mm |
|-------------|----------------------|----------|-------------|
| 1331 | Individual - LD | 12/16 | 3.3/1.3 |
| 261G1 | Reel - LD | 12/16 | 3.3/1.3 |
| 269G1-LPBK | Individual - LD | 12/16 | 3.3/1.3 |
| 269G1 | Reel - HD | 12/16 | 3.3/1.3 |
| 200G2L | Superflex, reel - LD | 16/20 | 1.3/.52 |
| 201G2H | Superflex, reel - HD | 16/20 | 1.3/.52 |

Housings Only

| Part Number | Description |
|-------------|---------------|
| 1327 | Red housing |
| 1327G5 | Green housing |
| 1327G6 | Black housing |
| 1327G7 | White housing |
| 1327G8 | Blue housing |

housings continued

| Part Number | Description |
|-------------|----------------|
| 1327G16 | Yellow housing |
| 1327G17 | Orange housing |
| 1327G18 | Gray housing |
| 1327G21 | Brown housing |
| 1327G22 | Pink housing |
| 1327G23 | Purple housing |

Accessories

| Part Number | Description |
|-------------|------------------------|
| 1441G1 | Female splash boot |
| 1442G1 | Male splash boot |
| 110G21 | Blok lok, 2 pole |
| 110G12 | Blok lok, 4 pole |
| 1399G9 | Red mounting wing |
| 1399G8 | Blue mounting wing |
| 110G68 | PP15/45 retention clip |

Note: For additional colors please contact customer service

* LD - low detent or HD - high detent

HEADQUARTERS: 13 Pratts Junction Road, P.O. Box 579, Sterling, MA 01564 T:978-422-3600 F:978-422-3700

EUROPE: Rahealy Road, Fermoy Co. Cork, Ireland T:353-(0)25-32277 F:353-(0)25-32296

ASIA/PACIFIC: IDEAL Anderson Asia Pacific Ltd., Unit 922-928 Topsail Plaza, 11 On Sum Street, Shatin N.T., Hong Kong T:852-2636-0836 F:852-2635-9036

CHINA: IDEAL Anderson Technologies (Shenzhen) Ltd., Block A8 Tantou W. Ind. Par, Songgang Baoan District, Shenzhen, PR. China 51810 T: 86-755-2768-2118 F: 86-755-2768-2218

TAIWAN: IDEAL Anderson Asia Pacific Ltd., Taiwan Branch, 4F-2, No.116, Dadun 20th St., Situn District, Taichung City 407, Taiwan (R.O.C.) T: 886-4-2310-6451 F:886-4-2310-6460

www.andersonpower.com

ORDERING INFORMATION

accessories continued

| Part Number | Description |
|-------------|--|
| 1399G1* | Red short spacer with end hole |
| 1399G2* | Red long spacer |
| 1399G6* | Red short spacer without hole |
| 1462G1 | 2 & 4 pole mounting clamp set |
| 1462G2 | 3 & 6 pole mounting clamp set |
| 1462G3 | 4 & 8 pole mounting clamp set |
| 110G16 | Retaining pins, 1 high block of connectors |
| 110G17 | Retaining pins, 2 high block of connectors |

* Contact customer service for additional colors

Tooling

| Part Number | Description |
|-------------|-----------------------------------|
| 111038G2 | Contact insertion/extraction tool |
| 1309G2 | Hand tool #12 to #20 |
| 1309G5 | Hand tool for p/n 200G2L & 201G2H |
| 260G1 | Applicator only (110V & 220V) |
| 260G14* | Applicator only (110V & 220V) |
| 260G15* | Applicator only (110V & 220V) |
| 260G18** | Applicator only (110V & 220V) |
| 280G1 | Applicator and press (110V, 60Hz) |
| 250G1 | Press only (110V, 60Hz) |
| 280G4 | Applicator and press (220V, 50Hz) |
| 250G2 | Press only (220V, 50Hz) |

* Denotes mini-style applicator for use with existing "K" or "T" press

** Denotes mini-style applicator for use with existing "K" or "T" and "G" press

DIMENSIONS

Housing

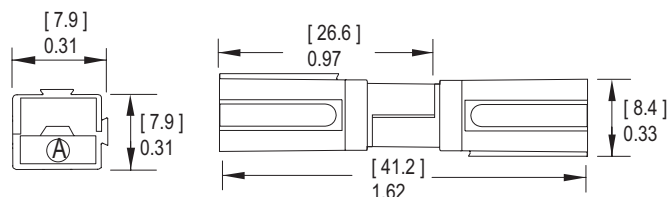

Contacts

| Part Number | -A- | | -B- | | -C- | | -D- | | -E- | |
|-------------|------|------|-----|------|-----|------|-----|------|-----|------|
| | mm | in. | mm | in. | mm | in. | mm | in. | mm | in. |
| 1331 | 16.3 | 0.64 | 7.7 | 0.31 | 3.7 | 0.15 | 2.6 | 0.10 | 3.7 | 0.15 |
| 261G1 | 17.3 | 0.68 | 6.4 | 0.25 | 4.6 | 0.18 | N/A | | 3.6 | 0.14 |
| 269G1-LPBK | 17.2 | 0.68 | 6.4 | 0.25 | 4.5 | 0.18 | N/A | | 3.6 | 0.14 |
| 269G1 | 17.2 | 0.68 | 6.4 | 0.25 | 4.5 | 0.18 | N/A | | 3.6 | 0.14 |
| 200G2L | 17.3 | 0.68 | 6.4 | 0.25 | 4.1 | 0.16 | N/A | | 3.6 | 0.14 |
| 201G2H | 17.2 | 0.68 | 6.4 | 0.25 | 4.1 | 0.16 | N/A | | 3.6 | 0.14 |

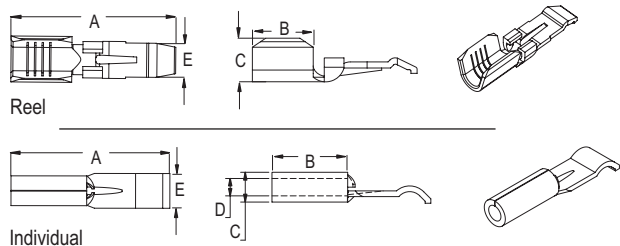

CSA Certified
File No. LR25154

RUUS®
File No. E26226

All Data Subject To Change Without Notice

TEMPERATURE RISE CHARTS

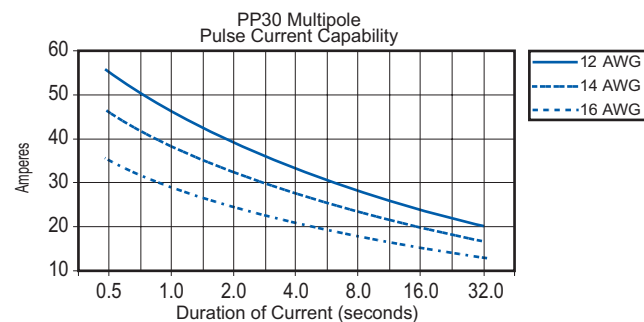
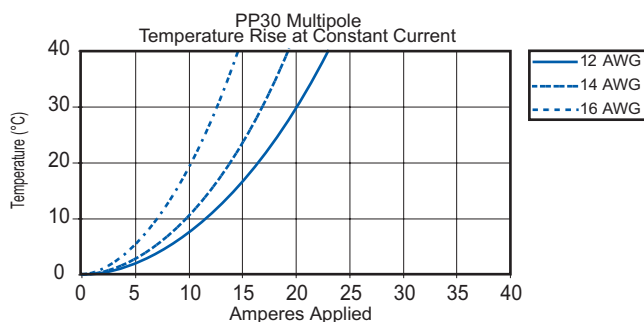
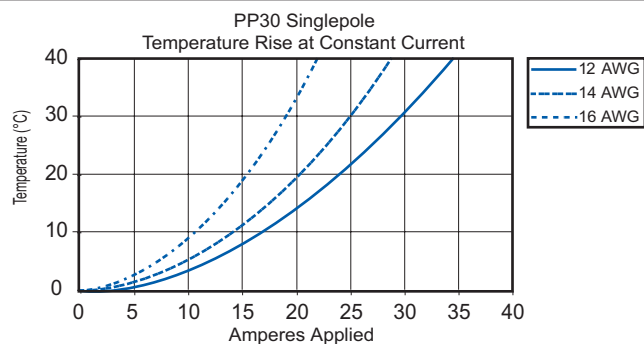

Mounting Clamps

| Part Number | -A- | | -B- | | -C- | | -D- | | Number of Poles |
|-------------|------|------|------|------|------|------|-----|------|-----------------|
| | mm | in. | mm | in. | mm | in. | mm | in. | |
| 1462G1 | 23.9 | 0.94 | 26.9 | 1.06 | 17.3 | 0.68 | 4.0 | 0.16 | (2 Pole) |
| 1462G1 | 23.9 | 0.94 | 35.0 | 1.38 | 25.4 | 1.00 | 4.0 | 0.16 | (4 Pole) |
| 1462G2 | 31.7 | 1.25 | 26.9 | 1.06 | 17.3 | 0.68 | 4.0 | 0.16 | (3 Pole) |
| 1462G2 | 31.7 | 1.25 | 35.0 | 1.38 | 25.4 | 1.00 | 4.0 | 0.16 | (6 Pole) |
| 1462G3 | 39.6 | 1.56 | 26.9 | 1.06 | 17.3 | 0.68 | 4.0 | 0.16 | (4 Pole) |
| 1462G3 | 39.6 | 1.56 | 35.0 | 1.38 | 25.4 | 1.00 | 4.0 | 0.16 | (8 Pole) |

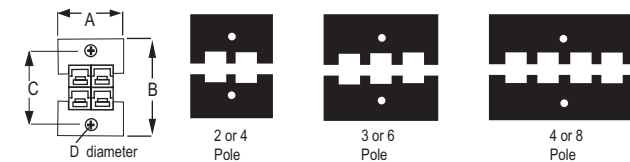

HEADQUARTERS: 13 Pratts Junction Road, P.O. Box 579, Sterling, MA 01564 T:978-422-3600 F:978-422-3700

EUROPE: Rathealy Road, Fermoy Co. Cork, Ireland T:353-(0)25-32277 F:353-(0)25-32296

ASIA/PACIFIC: IDEAL Anderson Asia Pacific Ltd., Unit 922-928 Topsail Plaza, 11 On Sum Street, Shatin N.T., Hong Kong T:852-2636-0836 F:852-2635-9036

CHINA: IDEAL Anderson Technologies (Shenzhen) Ltd., Block A8 Tantou W. Ind. Par, Songgang Baoan District, Shenzhen, PR. China 51810 T: 86-755-2768-2118 F: 86-755-2768-2218

TAIWAN: IDEAL Anderson Asia Pacific Ltd., Taiwan Branch, 4F-2, No.116, Dadun 20th St., Situn District, Taichung City 407, Taiwan (R.O.C.) T: 886-4-2310-6451 F:886-4-2310-6460

www.andersonpower.com

Powerpole® connectors provide cost-effective reliability, design flexibility and safety for your products' manufacture, installation and maintenance.

The housings are modular and genderless. Powerpole® connectors provide 600 Volts continuous, AC or DC operation. Wire sizes range from #10 to #14 AWG (5.3 to 2.1 mm²). Contacts are available in reeled and loose piece designs to support all production needs from engineering prototype, low volume and high volumes products.

FEATURES

• Flat wiping contact system

Minimal contact resistance at high current, wiping action cleans contact surface during connection/disconnection

• Colored modular housings

Provides visual identification of proper mating connector

• Molded-in dovetails

Secures individual connectors into "keyed" assemblies which prevents misconnection with similar configurations



PRODUCT SPECIFICATIONS

| Connector Model | PP45 | Connector Model | PP45 |
|---|--------------------------|---|-----------------------------------|
| UL Current Rating (Amperes)* | 45* | Life | |
| UL Voltage Ratings (Volts)** | 600* | a. No load (Contact/Disconnect Cycles) | To 10,000 |
| Contact Barrel Wire Size (AWG) (mm ²) | #10 to #14 5.3 to 2.1 | b. Under Load (Hot Plug 250 cycles @ 120V) | 30A |
| Maximum Wire Insulation Diameter (inches) (mm) | 0.175 4.45 | Avg. Connection/Disconnect (lbf) | 3 - low detent 5 - high detent |
| AVG Contact Resistance* (micro-ohms) | 525 | Operating Temperature Range °C*** °F | -20° to 105° -4° to 221° |
| Insulation Withstanding Test Voltage (Volts AC/DC) | 2200 | Flammability Rating of Housing Material | UL94 V-0 |
| Contact Retention Force (lbf) | 25 |  * UL Rated for 65°C largest wire or cable size ** Both AC & DC Voltage *** Contact factory for higher temperature rated connectors | |

ORDERING INFORMATION

Housing & 45 amp Contact

| Part Number | Housing Color | Wire | |
|-------------|---------------|-------|---------|
| | | AWG | sq. mm |
| 1345 | Red | 10/14 | 5.3/2.1 |
| 1345G5 | Green | 10/14 | 5.3/2.1 |
| 1345G6 | Black | 10/14 | 5.3/2.1 |
| 1345G7 | White | 10/14 | 5.3/2.1 |
| 1345G8 | Blue | 10/14 | 5.3/2.1 |
| 1345G16 | Yellow | 10/14 | 5.3/2.1 |
| 1345G17 | Orange | 10/14 | 5.3/2.1 |
| 1345G18 | Gray | 10/14 | 5.3/2.1 |
| 1345G21 | Brown | 10/14 | 5.3/2.1 |
| 1345G22 | Pink | 10/14 | 5.3/2.1 |
| 1345G23 | Purple | 10/14 | 5.3/2.1 |

contacts continued

| Part Number | Description | Wire | |
|-------------|----------------------|-------|---------|
| | | AWG | sq. mm |
| 261G2-LPBK | Individual - LD | 10/14 | 5.3/2.1 |
| 200G1L | Superflex, reel - LD | 10/14 | 5.3/2.1 |
| 201G1H | Superflex, reel - HD | 10/14 | 5.3/2.1 |

housings continued

| Part Number | Description |
|-------------|----------------|
| 1327G22 | Pink housing |
| 1327G23 | Purple housing |

Housings Only

| Part Number | Description |
|-------------|----------------|
| 1327 | Red housing |
| 1327G5 | Green housing |
| 1327G6 | Black housing |
| 1327G7 | White housing |
| 1327G8 | Blue housing |
| 1327G16 | Yellow housing |
| 1327G17 | Orange housing |
| 1327G18 | Gray housing |
| 1327G21 | Brown housing |

Accessories

| Part Number | Description |
|-------------|--------------------------------|
| 1441G1 | Female splash boot |
| 1442G1 | Male splash boot |
| 110G21 | Blok lok, 2 pole |
| 110G12 | Blok lok, 4 pole |
| 1399G9 | Red mounting wing |
| 1399G8 | Blue mounting wing |
| 1399G1 | Red short spacer with end hole |
| 1399G2 | Red long spacer |
| 1399G6 | Red short spacer without hole |
| 1462G1 | 2 & 4 pole mounting clamp set |
| 110G68 | PP15/45 retention clip |

45 amp Contacts*

| Part Number | Description | Wire | |
|-------------|-------------|-------|---------|
| | | AWG | sq. mm |
| 261G2 | Reel - LD | 10/14 | 5.3/2.1 |
| 269G3 | Reel - HD | 10/14 | 5.3/2.1 |

* LD - low detent or HD - high detent

Note: For additional colors please contact customer service

HEADQUARTERS: 13 Pratts Junction Road, P.O. Box 579, Sterling, MA 01564 T:978-422-3600 F:978-422-3700

EUROPE: Rathealy Road, Fermoy Co. Cork, Ireland T:353-(0)25-32277 F:353-(0)25-32296

ASIA/PACIFIC: IDEAL Anderson Asia Pacific Ltd., Unit 922-928 Topsail Plaza, 11 On Sum Street, Shatin N.T., Hong Kong T:852-2636-0836 F:852-2635-9036

CHINA: IDEAL Anderson Technologies (Shenzhen) Ltd., Block A8 Tantou W. Ind. Par, Songgang Baoan District, Shenzhen, PR. China 51810 T: 86-755-2768-2118 F: 86-755-2768-2218

TAIWAN: IDEAL Anderson Asia Pacific Ltd., Taiwan Branch, 4F-2, No.116, Dadun 20th St., Situn District, Taichung City 407, Taiwan (R.O.C.) T: 886-4-2310-6451 F:886-4-2310-6460

www.andersonpower.com

ORDERING INFORMATION

accessories continued

| Part Number | Description |
|-------------|--|
| 1462G2 | 3 & 6 pole mounting clamp set |
| 1462G3 | 4 & 8 pole mounting clamp set |
| 110G16 | Retaining pins, 1 high block of connectors |
| 110G17 | Retaining pins, 2 high block of connectors |

Tooling

| Part Number | Description |
|-------------|-----------------------------------|
| 111038G2 | Contact insertion/extraction tool |
| 1309G3 | Hand tool for p/n 261G2-LPBK |
| 1309G5 | Hand tool for p/n 200G2L & 201G2H |
| 260G1 | Applicator only (110V & 220V) |
| 260G14* | Applicator only (110V & 220V) |
| 260G15* | Applicator only (110V & 220V) |
| 260G18** | Applicator only (110V & 220V) |
| 280G1 | Applicator and press (110V, 60Hz) |
| 250G1 | Press only (110V, 60Hz) |
| 280G4 | Applicator and press (220V, 50Hz) |
| 250G2 | Press only (220V, 50Hz) |

* Denotes mini-style applicator for use with existing "K" or "T" press

** Denotes mini-style applicator for use with existing "K" or "T" and "G" press

DIMENSIONS

Housing

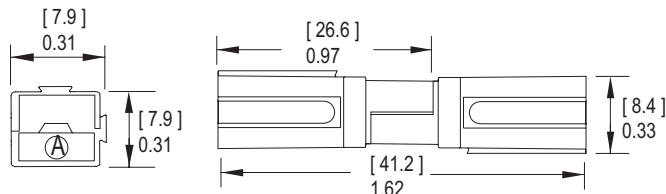

Contacts

| Part Number | -A- | | -B- | | -C- | | -E- | |
|-------------|------|------|-----|------|-----|------|-----|------|
| | mm | in. | mm | in. | mm | in. | mm | in. |
| 200G1L | 17.3 | 0.68 | 6.4 | 0.25 | 6.1 | 0.24 | 3.6 | 0.14 |
| 201G1H | 17.2 | 0.68 | 6.4 | 0.25 | 6.1 | 0.24 | 3.6 | 0.14 |
| 261G2 | 17.3 | 0.68 | 6.4 | 0.25 | 5.1 | 0.20 | 3.6 | 0.14 |
| 261G2-LPBK | 17.3 | 0.68 | 6.4 | 0.25 | 5.1 | 0.20 | 3.6 | 0.14 |
| 269G3 | 17.2 | 0.68 | 6.4 | 0.25 | 5.3 | 0.20 | 3.6 | 0.14 |

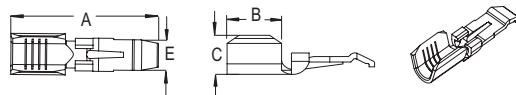

Spacers & Mounting Wings

| Part Number | -A- | | -B- | | -C- | |
|-------------|------|------|-----|------|-----|------|
| | mm | in. | mm | in. | mm | in. |
| 1399G1 | 16.6 | .655 | 7.9 | .312 | N/A | |
| 1399G2 | 24.6 | .968 | 7.9 | .312 | N/A | |
| 1399G6 | 16.6 | .655 | 7.9 | .312 | N/A | |
| 1399G8 | 16.6 | .655 | 7.9 | .312 | 4.6 | .180 |
| 1399G9 | 16.6 | .655 | 7.9 | .312 | 4.6 | .180 |

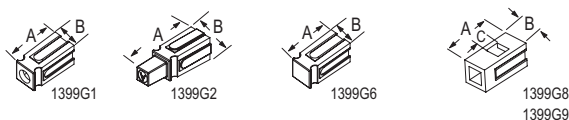

CSA Certified
File No. LR25154

UL US File No. E26226

All Data Subject To Change Without Notice

TEMPERATURE RISE CHARTS

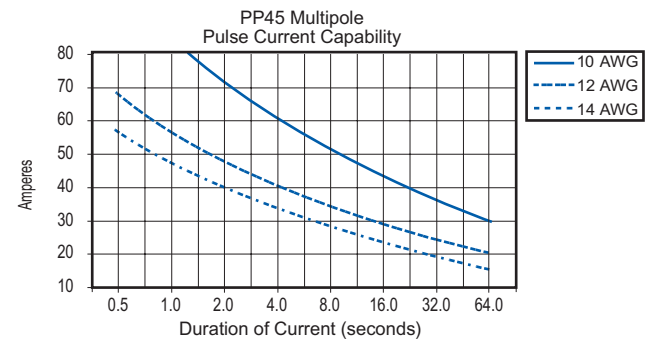
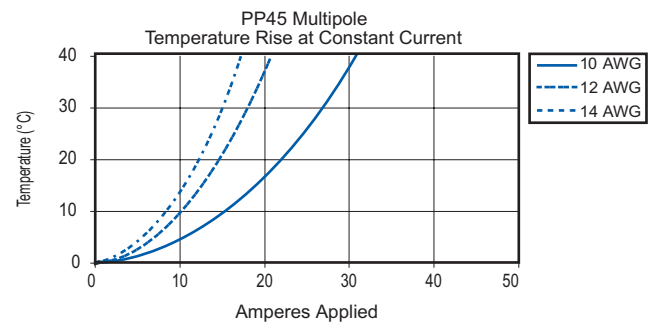
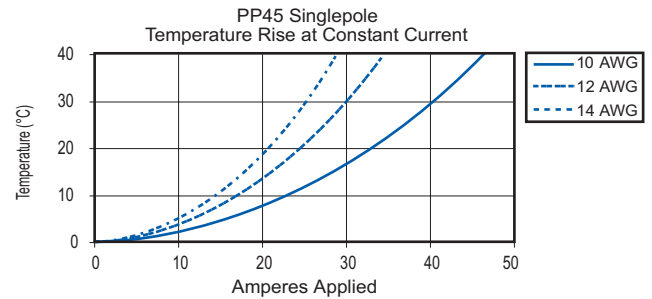

Mounting Clamps

| Part Number | -A- | -B- | -C- | -D- | Number of Poles | |
|-------------|------|------|------|------|-----------------|----------|
| | mm | in. | mm | in. | | |
| 1462G1 | 23.9 | 0.94 | 26.9 | 1.06 | 17.3 0.68 | (2 Pole) |
| 1462G1 | 23.9 | 0.94 | 35.0 | 1.38 | 25.4 1.00 | (4 Pole) |
| 1462G2 | 31.7 | 1.25 | 26.9 | 1.06 | 17.3 0.68 | (3 Pole) |
| 1462G2 | 31.7 | 1.25 | 35.0 | 1.38 | 25.4 1.00 | (6 Pole) |
| 1462G3 | 39.6 | 1.56 | 26.9 | 1.06 | 17.3 0.68 | (4 Pole) |
| 1462G3 | 39.6 | 1.56 | 35.0 | 1.38 | 25.4 1.00 | (8 Pole) |

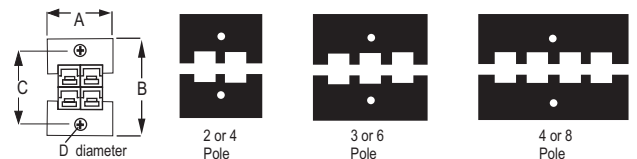

HEADQUARTERS: 13 Pratts Junction Road, P.O. Box 579, Sterling, MA 01564 T:978-422-3600 F:978-422-3700

EUROPE: Rathealy Road, Fermoy Co. Cork, Ireland T:353-(0)25-32277 F:353-(0)25-32296

ASIA/PACIFIC: IDEAL Anderson Asia Pacific Ltd., Unit 922-928 Topsail Plaza, 11 On Sum Street, Shatin N.T., Hong Kong T:852-2636-0836 F:852-2635-9036

CHINA: IDEAL Anderson Technologies (Shenzhen) Ltd., Block A8 Tantou W. Ind. Par, Songgang Baoan District, Shenzhen, P.R. China 51810 T: 86-755-2768-2118 F: 86-755-2768-2218

TAIWAN: IDEAL Anderson Asia Pacific Ltd., Taiwan Branch, 4F-2, No.116, Dadun 20th St., Situn District, Taichung City 407, Taiwan (R.O.C.) T: 886-4-2310-6451 F:886-4-2310-6460

www.andersonpower.com

The PP15/45 Finger Proof is designed specifically for high voltage applications where personal safety is critical. The connector meets the accessibility requirements of UL1977 section 10.2 and is recommended for applications over 50 volts.

Powerpole® connectors provide cost-effective reliability, design flexibility and safety for your products' manufacture, installation and maintenance.

Powerpole® connectors provide 600 Volts continuous, AC or DC operation. Wire sizes range from #10 to #20 AWG (5.3 to .5 mm²). Contacts are available in reeled and loose piece, to support production needs from low to high volumes.

FEATURES

• Finger proof

Minimizes the potential contact with live contacts, per UL 1977 and EN/IEC 60529 condition IP20

• Molded-in dovetails

Secures individual connectors into "keyed" assemblies which prevents misconnection with similar configurations

• Interchangeable genderless design

Makes assembly quick, easy and reduces number of parts stocked

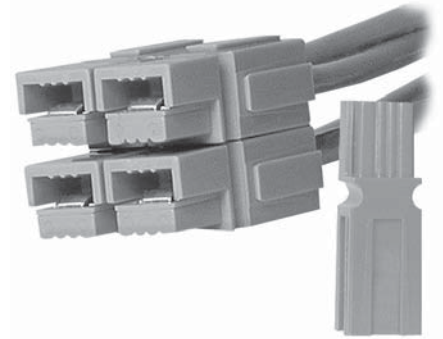

PRODUCT SPECIFICATIONS

| Connector Model | PP15 | PP30 | PP45 | Connector Model | PP15 | PP30 | PP45 |
|--|-----------|-----------|-----------|--|-------------------------------|-------------------------------|-------------------------------|
| UL Current Rating (Amperes)* | 15* | 30* | 45* | Life | | | |
| UL Voltage Ratings (Volts)** | 600* | 600* | 600* | a. No load (Contact/Disconnect Cycles) | To 10,000 | To 10,000 | To 10,000 |
| Contact Barrel Wire Size (AWG) | #16 - #20 | #12 - #16 | #10 - #14 | b. Under Load (Hot Plug 250 cycles @ 120V) | 15A | 30A | 30A |
| (mm ²) | 1.3 to .5 | 3.3 - 1.3 | 5.3 - 2.1 | Avg. Connection/Disconnect (lbf) | 3-low detent 5-high detent | 3-low detent 5-high detent | 3-low detent 5-high detent |
| Maximum Wire Insulation Diameter (inches) | 0.175 | 0.175 | 0.175 | Operating Temperature Range °C*** | -20° to 105° | -20° to 105° | -20° to 105° |
| (mm) | 4.45 | 4.45 | 4.45 | °F | -4° to 221° | -4° to 221° | -4° to 221° |
| AVG Contact Resistance* (micro-ohms) | 875 | 600 | 525 | Flammability Rating of Housing Material | UL94 V-0 | UL94 V-0 | UL94 V-0 |
| Insulation Withstanding Test Voltage (Volts AC/DC) | 2200 | 2200 | 2200 | | | | |
| Contact Retention Force (lbf) | 25 | 25 | 35 | | | | |



* UL Rated for 65°C largest wire or cable size

** Both AC & DC Voltage

*** Contact factory for higher temperature rated connectors

ORDERING INFORMATION

Housings Only

| Part Number | Description |
|-------------|---------------|
| 1327FP | Red housing |
| 1327G5FP | Green housing |
| 1327G6FP | Black housing |
| 1327G7FP | White housing |
| 1327G8FP | Blue housing |

15 amp Contacts*

| Part Number | Description | AWG | sq. mm |
|-------------|----------------------|-------|---------|
| 1332 | Individual - LD | 16/20 | 1.3/.52 |
| 262G1 | Reel - LD | 16/20 | 1.3/.52 |
| 269G2 | Reel - HD | 16/20 | 1.3/.52 |
| 269G2-LPBK | Individual - HD | 16/20 | 1.3/.52 |
| 200G2L | Superflex, reel - LD | 16/20 | 1.3/.52 |
| 201G2H | Superflex, reel - HD | 16/20 | 1.3/.52 |

30 amp Contacts*

| Part Number | Description | AWG | sq. mm |
|-------------|-----------------------|-------|---------|
| 1331 | Individual - LD | 12/16 | 3.3/1.3 |
| 261G1 | Reel - LD | 12/16 | 3.3/1.3 |
| 269G1-LPBK | Loose piece-bulk - HD | 12/16 | 3.3/1.3 |
| 269G1 | Reel - HD | 12/16 | 3.3/1.3 |
| 200G2L | Superflex, reel - LD | 16/20 | 1.3/.52 |
| 201G2H | Superflex, reel - HD | 16/20 | 1.3/.52 |

45 amp Contacts*

| Part Number | Description | AWG | sq. mm |
|-------------|-----------------|-------|---------|
| 261G2 | Reel, Low Det | 10/14 | 5.3/2.1 |
| 269G3 | Reel, High Det | 10/14 | 5.3/2.1 |
| 261G2-LPBK | Individual | 10/14 | 5.3/2.1 |
| 200G1L | Superflex, reel | 10/14 | 5.3/2.1 |
| 201G1H | Superflex, reel | 10/14 | 5.3/2.1 |

Accessories

| Part Number | Description |
|-------------|--|
| 1441G1 | Female splash boot |
| 1442G1 | Male splash boot |
| 110G21 | Blok lok, 2 pole |
| 110G12 | Blok lok, 4 pole |
| 1399G9 | Red mounting wing |
| 1399G8 | Blue mounting wing |
| 1399G1 | Red short spacer with end hole |
| 1399G2 | Red long spacer |
| 1399G6 | Red short spacer without hole |
| 1462G1 | 2 & 4 pole mounting clamp set |
| 1462G2 | 3 & 6 pole mounting clamp set |
| 1462G3 | 4 & 8 pole mounting clamp set |
| 110G16 | Retaining pins, 1 high block of connectors |
| 110G17 | Retaining pins, 2 high block of connectors |

* LD - low detent or HD - high detent

Note: For additional colors please contact customer service

HEADQUARTERS: 13 Pratts Junction Road, P.O. Box 579, Sterling, MA 01564 T:978-422-3600 F:978-422-3700

EUROPE: Rathealy Road, Fermoy Co. Cork, Ireland T:353-(0)25-32277 F:353-(0)25-32296

ASIA/PACIFIC: IDEAL Anderson Asia Pacific Ltd., Unit 922-928 Topsail Plaza, 11 On Sum Street, Shatin N.T., Hong Kong T:852-2636-0836 F:852-2635-9036

CHINA: IDEAL Anderson Technologies (Shenzhen) Ltd., Block A8 Tantou W. Ind. Par. Songgang Baoan District, Shenzhen, PR. China 51810 T: 86-755-2768-2118 F: 86-755-2768-2218

TAIWAN: IDEAL Anderson Asia Pacific Ltd., Taiwan Branch, 4F.-2, No.116, Dadun 20th St., Situn District, Taichung City 407, Taiwan (R.O.C.) T: 886-4-2310-6451 F:886-4-2310-6460

www.andersonpower.com

DIMENSIONS

Contacts

| Part Number | -A- | | -B- | | -C- | | -D- | | -E- | |
|-------------|------|------|-----|------|-----|------|-----|------|-----|------|
| | mm | in. | mm | in. | mm | in. | mm | in. | mm | in. |
| 1332 | 16.3 | 0.64 | 7.8 | 0.31 | 3.1 | 0.12 | 1.8 | 0.07 | 3.6 | 0.14 |
| 1331 | 16.3 | 0.64 | 7.7 | 0.31 | 3.7 | 0.15 | 2.6 | 0.10 | 3.7 | 0.15 |
| 261G1 | 17.3 | 0.68 | 6.4 | 0.25 | 4.6 | 0.18 | N/A | | 3.6 | 0.14 |
| 261G2 | 17.3 | 0.68 | 6.4 | 0.25 | 5.1 | 0.20 | N/A | | 3.6 | 0.14 |
| 261G2-LPBK | 17.3 | 0.68 | 6.4 | 0.25 | 5.1 | 0.20 | N/A | | 3.6 | 0.14 |
| 262G1 | 17.2 | 0.68 | 6.4 | 0.25 | 4.1 | 0.16 | N/A | | 3.6 | 0.14 |
| 269G1 | 17.2 | 0.68 | 6.4 | 0.25 | 4.5 | 0.18 | N/A | | 3.6 | 0.14 |
| 269G1-LPBK | 17.2 | 0.68 | 6.4 | 0.25 | 4.5 | 0.18 | N/A | | 3.6 | 0.14 |
| 269G2 | 17.2 | 0.68 | 6.4 | 0.25 | 4.1 | 0.16 | N/A | | 3.6 | 0.14 |
| 269G2-LPBK | 17.2 | 0.68 | 6.4 | 0.25 | 4.1 | 0.16 | N/A | | 3.6 | 0.14 |
| 269G3 | 17.2 | 0.68 | 6.4 | 0.25 | 5.3 | 0.21 | N/A | | 3.6 | 0.14 |
| 200G2L | 17.3 | 0.68 | 6.4 | 0.25 | 4.1 | 0.16 | N/A | | 3.6 | 0.14 |
| 201G2H | 17.3 | 0.68 | 6.4 | 0.25 | 4.1 | 0.16 | N/A | | 3.6 | 0.14 |
| 200G1L | 17.3 | 0.68 | 6.4 | 0.25 | 6.1 | 0.24 | N/A | | 3.6 | 0.14 |
| 201G1H | 17.2 | 0.68 | 6.4 | 0.25 | 6.1 | 0.24 | N/A | | 3.6 | 0.14 |

Housing

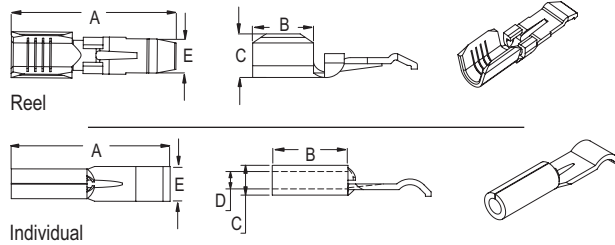
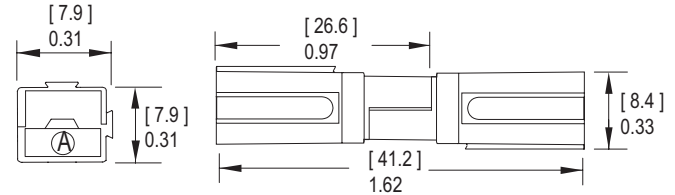

ORDERING INFORMATION

Tooling

| Part Number | Description |
|-------------|-----------------------------------|
| 111038G2 | Contact insertion/extraction tool |
| 1309G2 | Hand tool #12 to #20 |
| 1309G5 | Hand tool for p/n 200G2L & 201G2H |
| 260G1 | Applicator only (110V & 220V) |
| 260G14* | Applicator only (110V & 220V) |
| 260G15* | Applicator only (110V & 220V) |
| 260G18** | Applicator only (110V & 220V) |
| 280G1 | Applicator and press (110V, 60Hz) |
| 250G1 | Press only (110V, 60Hz) |
| 280G4 | Applicator and press (220V, 50Hz) |
| 250G2 | Press only (220V, 50Hz) |

* Denotes mini-style applicator for use with existing "K" or "T" press

** Denotes mini-style applicator for use with existing "K" or "T" and "G" press

TEMPERATURE RISE CHARTS

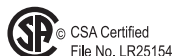
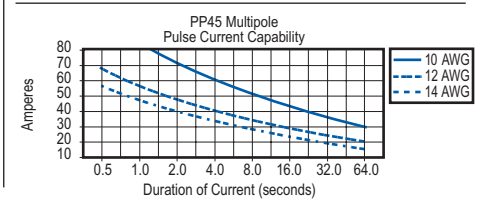
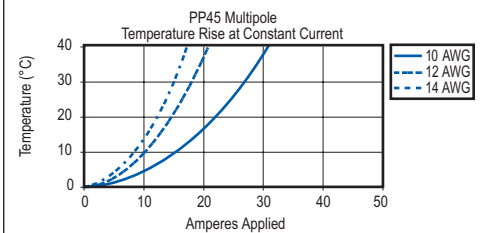
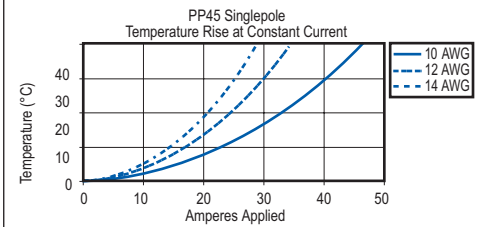
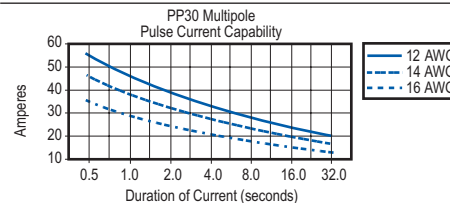
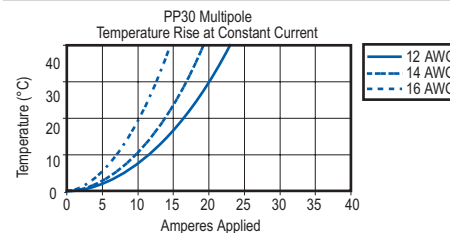
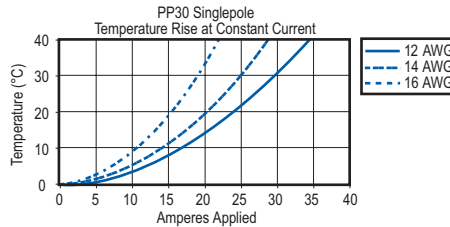
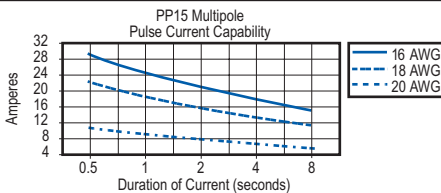
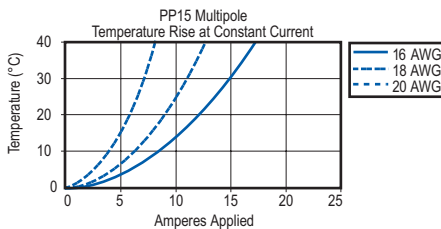
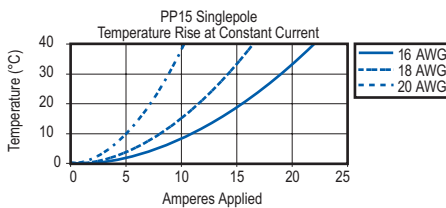

All Data Subject To Change Without Notice

HEADQUARTERS: 13 Pratts Junction Road, P.O. Box 579, Sterling, MA 01564 T:978-422-3600 F:978-422-3700

EUROPE: Rathealy Road, Fermoy Co. Cork, Ireland T:353-(0)25-32277 F:353-(0)25-32296

ASIA/PACIFIC: IDEAL Anderson Asia Pacific Ltd., Unit 922-928 Topsail Plaza, 11 On Sum Street, Shatin N.T., Hong Kong T:852-2636-0836 F:852-2635-9036

CHINA: IDEAL Anderson Technologies (Shenzhen) Ltd., Block A8 Tantou W. Ind. Par, Songgang Baoan District, Shenzhen, P.R. China 51810 T: 86-755-2768-2118 F: 86-755-2768-2218

TAIWAN: IDEAL Anderson Asia Pacific Ltd., Taiwan Branch, 4F.-2, No.116, Dadun 20th St., Situn District, Taichung City 407, Taiwan (R.O.C.) T: 886-4-2310-6451 F:886-4-2310-6460

www.andersonpower.com

Powerpole® connectors provide cost-effective reliability, design flexibility and safety for your products' manufacture, installation and maintenance.

The housings are modular and genderless. Powerpole® connectors provide 600 Volts continuous, AC or DC operation. Wire sizes range from #6 to #16 AWG (13.3 to 1.3 mm²). Contacts are available in reeled and loose piece designs to support all production needs from engineering prototype, low volume and high volumes products. Low-detent contacts are also offered for low insertion/withdrawal force applications.

FEATURES

• Flat wiping contact system

Minimal contact resistance at high current, wiping action cleans contact surface during connection/disconnection

• Colored modular housings

Provides visual identification of proper mating connector

• Molded-in dovetails

Secures individual connectors into "keyed" assemblies which prevents misconnection with similar configurations



PRODUCT SPECIFICATIONS

| Connector Model | PP75 | Connector Model | PP75 |
|--|-------------|--|-----------------------------------|
| UL Current Rating (Amperes)* | 75* | Life | |
| UL Voltage Ratings (Volts)** | 600* | a. No load (Contact/Disconnect Cycles) | To 10,000 |
| Contact Barrel Wire Size (AWG) | #6 to #16 | b. Under Load (Hot Plug 250 cycles @ 120V) | 50A |
| (mm) | 13.3 to 1.3 | Avg. Connection/Disconnect (lbf) | 5 - low detent 7 - high detent |
| Maximum Wire Insulation Diameter (inches) | 0.437 | Operating Temperature Range °C*** | -20° to 105° |
| (mm) | 11.10 | °F | -4° to 221° |
| AVG Contact Resistance* (micro-ohms) | 200 | Flammability Rating of Housing Material | UL94 V-0 |
| Insulation Withstanding Test Voltage (Volts AC/DC) | 2200 | | |
| Contact Retention Force (lbf) | 50 | | |



* UL Rated for 75°C largest wire or cable size

** Both AC & DC Voltage

*** Contact factory for higher temperature rated connectors

ORDERING INFORMATION

Housing & 75 amp Contact

| Part Number | Housing Color | Wire AWG | sq. mm |
|-------------|---------------|----------|--------|
| 1300 | Blue | #6 | 13.3 |
| 1300G2 | Green | #6 | 13.3 |
| 1300G3 | Red | #6 | 13.3 |
| 1300G4 | Black | #6 | 13.3 |
| 1300G5 | White | #6 | 13.3 |

75 amp Contacts***

| Part Number | Description | Wire AWG | sq. mm |
|-------------|--------------------------|----------|----------|
| 1307 | Individual - LD | #6 | 13.3 |
| 5900 | Individual - HD | #6 | 13.3 |
| 5914 | Individual - HD | #10 | 5.3 |
| 5915 | Individual - HD | #10/12 | 5.3/3.3 |
| 5952 | Individual - HD | #8 | 8.4 |
| 5953 | Individual - LD | #10/12 | 5.3/3.3 |
| 904G1 | Set of (2) 5915 Contacts | #10/12 | 5.3/3.3 |
| 903G1 | Set of (2) 5900 Contacts | #6 | 13.3 |
| 265G1 | Reel, silver - HD | #6/8 | 13.3/8.4 |

contacts continued

| Part Number | Description | Wire AWG | sq. mm |
|-------------|------------------------|----------|----------|
| 265G2* | Reel, silver - HD | #10/12 | 5.3/3.3 |
| 265G3 | Reel, silver - LD | #6/8 | 13.3/8.4 |
| 265G4* | Reel, silver - LD | #10/12 | 5.3/3.3 |
| 265G5 | Reel, tin - HD | #6/8 | 13.3/8.4 |
| 265G6** | Reel, tin - HD | #10/12 | 5.3/3.3 |
| 265G7 | Reel, tin - LD | #6/8 | 13.3/8.4 |
| 265G8** | Reel, tin - LD | #10/12 | 5.3/3.3 |
| 75BBS | 75 amp Bus bar contact | N/A | N/A |

Housings Only

| Part Number | Description |
|-------------|---------------|
| 5916 | Blue housing |
| 5916G4 | Black housing |
| 5916G5 | White housing |
| 5916G6 | Green housing |
| 5916G7 | Red housing |

Accessories

| Part Number | Description |
|-------------|--|
| 110G18 | Retaining Pins, 2 high block of connectors |
| 110G19 | Retaining Pins, 1 high block of connectors |
| 1399G20 | Mounting wing blue, round hole |
| 1399G7 | Mounting wing blue, oval hole |
| 1463G1 | 2 & 4 pole mounting clamp set |
| 1463G2 | 3 & 6 pole mounting clamp set |
| 110G57 | Lock nut for use with bus bar contact |

Bushings

| Part Number | Wire AWG | sq. mm |
|-----------------------|--------------|-----------------|
| Use with 5900 or 1307 | | |
| 5910 | #6 to #10/12 | 13.3 to 5.3/3.3 |
| 5912 | #6 to #8 | 13.3 to 8.4 |
| 5913 | #6 to #14/16 | 13.3 to 2.1/1.3 |

* Using 10/12 AWG wire reduces rating to 50 amps

** Using 10/12 AWG wire reduces rating to 40 amps

*** LD - low detent or HD - high detent

Note: For additional colors please contact customer service

HEADQUARTERS: 13 Pratts Junction Road, P.O. Box 579, Sterling, MA 01564 T:978-422-3600 F:978-422-3700

EUROPE: Rathealy Road, Fermoy Co. Cork, Ireland T:353-(0)25-32277 F:353-(0)25-32296

ASIA/PACIFIC: IDEAL Anderson Asia Pacific Ltd., Unit 922-928 Topsail Plaza, 11 On Sum Street, Shatin N.T., Hong Kong T:852-2636-0836 F:852-2635-9036

CHINA: IDEAL Anderson Technologies (Shenzhen) Ltd., Block A8 Tantou W. Ind. Par, Songgang Baoan District, Shenzhen, P.R. China 51810 T: 86-755-2768-2118 F: 86-755-2768-2218

TAIWAN: IDEAL Anderson Asia Pacific Ltd., Taiwan Branch, 4F.-2, No.116, Dadun 20th St., Situn District, Taichung City 407, Taiwan (R.O.C.) T: 886-4-2310-6451 F:886-4-2310-6460

www.andersonpower.com

ORDERING INFORMATION

Tooling

| Part Number | Description |
|-------------|---|
| 1309G4 | Hand tool, #16 to #6 |
| 1387G1 | Pneumatic tool, #16 to #6 |
| 1388G6 | - die for #16 to #6 AWG |
| 1388G7 | - die for #10 to #12 AWG (5914, 5915 & 5953 contacts) |
| 1389G6 | - locator for #16 to #6 AWG |
| 1389G7 | - locator for #10 to #12 AWG (5914, 5915 & 5953 contacts) |
| 260G16 | Applicator only (110V & 220V) |
| 284G1 | Applicator & Press (220V, 50Hz) |
| 250G5 | Press only (110V, 60Hz) |

DIMENSIONS

Housing

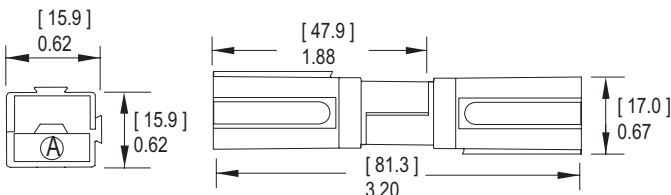

Contacts

| Part Number | -A- | | -B- | | -C- | | -D- | | -E- | | -F- |
|-------------|------|------|------|------|-----|------|-------------|------|------|------|------|
| | mm | in. | mm | in. | mm | in. | mm | in. | mm | in. | |
| 1307 | 30.0 | 1.18 | 7.2 | 0.28 | 5.6 | 0.22 | 11.4 | 0.45 | 7.1 | 0.28 | N/A |
| 5900 | 30.0 | 1.18 | 7.2 | 0.28 | 5.6 | 0.22 | 11.4 | 0.45 | 7.1 | 0.28 | N/A |
| 5914 | 29.7 | 1.17 | 4.8 | 0.19 | 3.5 | 0.14 | 11.4 | 0.45 | 7.1 | 0.28 | N/A |
| 5915 | 30.0 | 1.18 | 7.2 | 0.28 | 3.5 | 0.14 | 11.4 | 0.45 | 7.1 | 0.28 | N/A |
| 5952 | 30.0 | 1.18 | 7.2 | 0.28 | 4.7 | 0.19 | 11.4 | 0.45 | 7.1 | 0.28 | N/A |
| 5953 | 30.0 | 1.18 | 7.2 | 0.28 | 3.5 | 0.14 | 11.4 | 0.45 | 7.1 | 0.28 | N/A |
| 904G1 | 30.0 | 1.18 | 7.2 | 0.28 | 3.5 | 0.14 | 11.4 | 0.45 | 7.1 | 0.28 | N/A |
| 903G1 | 30.0 | 1.18 | 7.2 | 0.28 | 5.6 | 0.22 | 11.4 | 0.45 | 7.1 | 0.28 | N/A |
| 265G1 | 31.8 | 1.25 | 9.1 | 0.36 | 9.1 | 0.36 | 22.9 | 0.90 | 8.1 | 0.32 | N/A |
| 265G2 | 31.8 | 1.25 | 7.4 | 0.29 | 6.9 | 0.27 | 22.9 | 0.90 | 8.1 | 0.32 | N/A |
| 265G3 | 31.0 | 1.22 | 9.1 | 0.36 | 9.1 | 0.36 | 22.9 | 0.90 | 8.1 | 0.32 | N/A |
| 265G4 | 31.0 | 1.22 | 7.4 | 0.29 | 6.9 | 0.27 | 22.9 | 0.90 | 8.1 | 0.32 | N/A |
| 265G5 | 31.8 | 1.25 | 9.1 | 0.36 | 9.1 | 0.36 | 22.9 | 0.90 | 8.1 | 0.32 | N/A |
| 265G6 | 31.8 | 1.25 | 7.4 | 0.29 | 6.9 | 0.27 | 22.9 | 0.90 | 8.1 | 0.32 | N/A |
| 265G7 | 31.0 | 1.22 | 9.1 | 0.36 | 9.1 | 0.36 | 22.9 | 0.90 | 8.1 | 0.32 | N/A |
| 265G8 | 31.0 | 1.22 | 7.4 | 0.29 | 6.9 | 0.27 | 22.9 | 0.90 | 8.1 | 0.32 | N/A |
| 75BBS | 69.0 | 2.70 | 17.1 | 0.68 | 6.9 | 0.27 | #10-24 thd. | 1.0 | 0.04 | 2.0 | 0.08 |

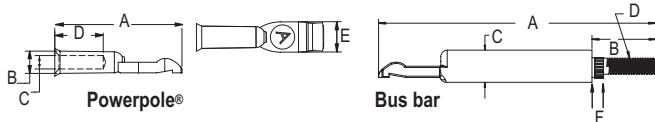

Mounting Clamps

| Part Number | -A- | | -B- | | -C- | | -D- | | -E- | | Number of Poles |
|-------------|------|------|------|------|------|------|------|------|-----|------|-----------------|
| | mm | in. | mm | in. | mm | in. | mm | in. | mm | in. | |
| 1463G1 | 41.1 | 1.62 | 34.7 | 1.37 | 27.1 | 1.07 | 31.8 | 1.25 | 4.0 | 0.16 | (2 Pole) |
| 1463G1 | 41.1 | 1.62 | 50.7 | 2.00 | 43.1 | 1.70 | 31.8 | 1.25 | 4.0 | 0.16 | (4 Pole) |
| 1463G2 | 57.2 | 2.25 | 34.7 | 1.37 | 27.1 | 1.07 | 47.6 | 1.88 | 4.0 | 0.16 | (3 Pole) |
| 1463G2 | 57.2 | 2.25 | 50.7 | 2.00 | 43.1 | 1.70 | 47.6 | 1.88 | 4.0 | 0.16 | (6 Pole) |

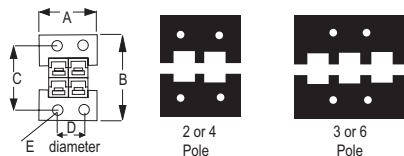

All Data Subject To Change Without Notice

TEMPERATURE RISE CHARTS

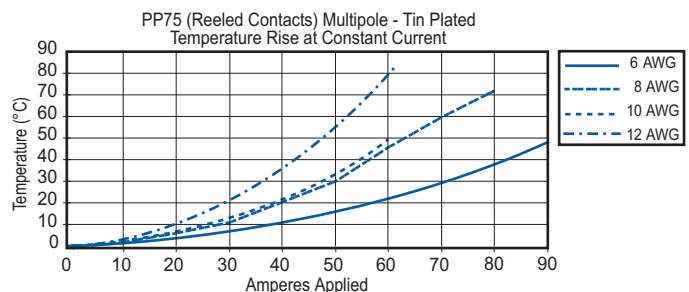
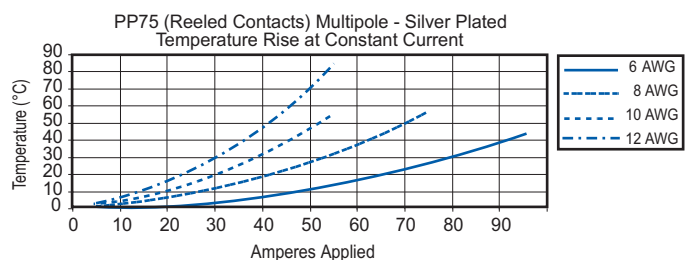
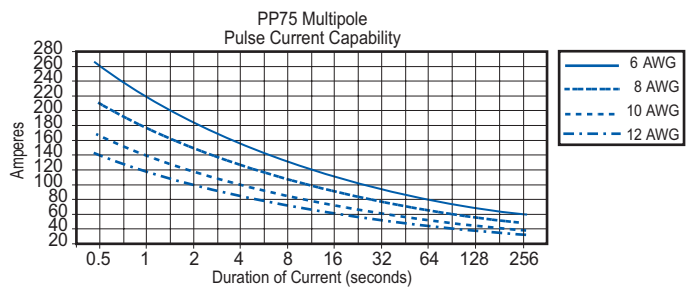
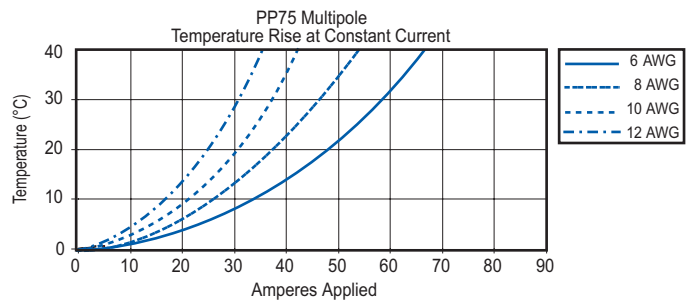
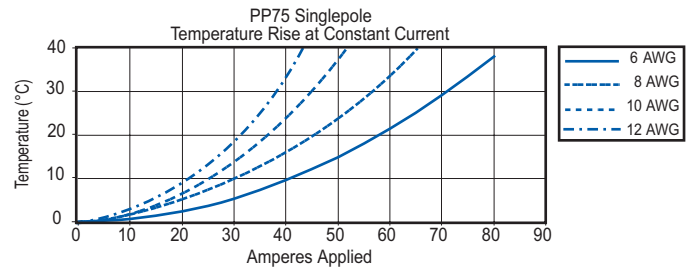

HEADQUARTERS: 13 Pratts Junction Road, P.O. Box 579, Sterling, MA 01564 T:978-422-3600 F:978-422-3700

EUROPE: Rathealy Road, Fermoy Co. Cork, Ireland T:353-(0)25-32277 F:353-(0)25-32296

ASIA/PACIFIC: IDEAL Anderson Asia Pacific Ltd., Unit 922-928 Topsail Plaza, 11 On Sum Street, Shatin N.T., Hong Kong T:852-2636-0836 F:852-2635-9036

CHINA: IDEAL Anderson Technologies (Shenzhen) Ltd., Block A8 Tantou W. Ind. Par, Songgang Baoan District, Shenzhen, P.R. China 51810 T: 86-755-2768-2118 F: 86-755-2768-2218

TAIWAN: IDEAL Anderson Asia Pacific Ltd., Taiwan Branch, 4F-2, No.116, Dadun 20th St., Situn District, Taichung City 407, Taiwan (R.O.C.) T: 886-4-2310-6451 F:886-4-2310-6460

www.andersonpower.com

In addition to all the unique features of our standard PP75 Powerpoles®, we offer a "Locking" version. The locking clips insure that the connector dovetails are attached securely without roll pins, which are required to secure other Powerpole® assemblies. Like our standard Powerpole® housing, the locking PP75 also offers a 600 Volts continuous, AC or DC operation. Wire sizes range from #6 to #16 AWG (13.3 to 1.3 mm²). The locking PP75 utilizes the same contacts and crimp tooling as our standard PP75 housing.

FEATURES

• Locking dovetail design

Provides positive mechanical spring latch, creating lockable/unlockable modules

• Horizontal/Vertical mounting wings or surface adaptor

Eliminates retaining pins, allows horizontal, vertical or direct mounting capability

• Molded-in dovetails

Securely locks modules into multipole configurations

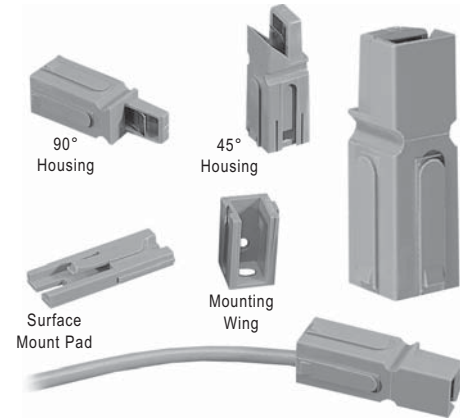

PRODUCT SPECIFICATIONS

| Connector Model | PP75 | Connector Model | PP75 |
|--|-------------|--|-----------------------------------|
| UL Current Rating (Amperes)* | 75**** | Life | |
| UL Voltage Ratings (Volts)** | 600* | a. No load (Contact/Disconnect Cycles) | To 10,000 |
| Contact Barrel Wire Size (AWG) | #6 to #16 | b. Under Load (Hot Plug 250 cycles @ 120V) | 50A |
| (mm) | 13.3 to 1.3 | Avg. Connection/Disconnect (lbf) | 5 - low detent 7 - high detent |
| Maximum Wire Insulation Diameter (inches) | 0.437 | Operating Temperature Range °C*** | -20° to 105° |
| (mm) | 11.10 | °F | -4° to 221° |
| AVG Contact Resistance* (micro-ohms) | 200 | Flammability Rating of Housing Material | UL94 V-0 |
| Insulation Withstanding Test Voltage (Volts AC/DC) | 2200 | | |
| Contact Retention Force (lbf) | 50 | * UL Rated for 65°C largest wire or cable size ** Both AC & DC Voltage *** Contact factory for higher temperature rated connectors **** For 75°C rated wire or cable size | |

ORDERING INFORMATION

Housing Only

| Part Number | Description |
|-------------|---------------------|
| 75LOKBLU | Blue housing |
| 75LOKGRA | Gray housing |
| 75LOKBLK | Black housing |
| 75LOKGRN | Green housing |
| 75LOKYEL | Yellow housing |
| 75LOKWHT | White housing |
| 75LOK45BLU | 45° locking housing |
| 75LOK90BLU | 90° locking housing |

contacts continued

| Part Number | Description | Wire | |
|-------------|--------------------------|--------|----------|
| | | AWG | sq. mm |
| 5915 | Individual - HD | #10/12 | 5.3/3.3 |
| 5952 | Individual - HD | #8 | 8.4 |
| 5953 | Individual - LD | #10/12 | 5.3/3.3 |
| 904G1 | Set of (2) 5915 Contacts | #10/12 | 5.3/3.3 |
| 903G1 | Set of (2) 5900 Contacts | #6 | 13.3 |
| 265G1 | Reel, silver - HD | #6/8 | 13.3/8.4 |
| 265G2* | Reel, silver - HD | #10/12 | 5.3/3.3 |
| 265G3 | Reel, silver - LD | #6/8 | 13.3/8.4 |
| 265G4* | Reel, silver - LD | #10/12 | 5.3/3.3 |
| 265G5 | Reel, tin - HD | #6/8 | 13.3/8.4 |
| 265G6** | Reel, tin - HD | #10/12 | 5.3/3.3 |
| 265G7 | Reel, tin - LD | #6/8 | 13.3/8.4 |
| 265G8** | Reel, tin - LD | #10/12 | 5.3/3.3 |
| 75BBS | 75 amp bus bar contact | N/A | N/A |

* Using 10/12 AWG wire reduces rating to 50 amps
 ** Using 10/12 AWG wire reduces rating to 40 amps
 *** LD - low detent or HD - high detent
 Note: For additional colors please contact customer service

Accessories

| Part Number | Description |
|---------------|---------------------------------------|
| 1463G1 | 2 & 4 pole mounting clamp set |
| 1463G2 | 3 & 6 pole mounting clamp set |
| 75 LOKSMTBLU | Surface mounting pad |
| 75LOKWNGBLU | Mounting wing (oval hole) |
| 75LOKWNGBLU-R | Mounting wing (round hole) |
| 110G57 | Lock nut for use with bus bar contact |

Bushings

| Part Number | Wire | |
|-----------------------|--------------|-----------------|
| | AWG | sq. mm |
| Use with 5900 or 1307 | | |
| 5910 | #6 to #10/12 | 13.3 to 5.3/3.3 |
| 5912 | #6 to #8 | 13.3 to 8.4 |
| 5913 | #6 to #14/16 | 13.3 to 2.1/1.3 |

75 amp Contacts***

| Part Number | Description | Wire | |
|-------------|-----------------|------|--------|
| | | AWG | sq. mm |
| 1307 | Individual - LD | #6 | 13.3 |
| 5900 | Individual - HD | #6 | 13.3 |
| 5914 | Individual - HD | #10 | 5.3 |

HEADQUARTERS: 13 Pratts Junction Road, P.O. Box 579, Sterling, MA 01564 T:978-422-3600 F:978-422-3700

EUROPE: Rathealy Road, Fermoy Co. Cork, Ireland T:353-(0)25-32277 F:353-(0)25-32296

ASIA/PACIFIC: IDEAL Anderson Asia Pacific Ltd., Unit 922-928 Topsail Plaza, 11 On Sum Street, Shatin N.T., Hong Kong T:852-2636-0836 F:852-2635-9036

CHINA: IDEAL Anderson Technologies (Shenzhen) Ltd., Block A8 Tantou W. Ind. Par. Songgang Baoan District, Shenzhen, PR. China 51810 T: 86-755-2768-2118 F: 86-755-2768-2218

TAIWAN: IDEAL Anderson Asia Pacific Ltd., Taiwan Branch, 4F.-2, No.116, Dadun 20th St., Situn District, Taichung City 407, Taiwan (R.O.C.) T: 886-4-2310-6451 F:886-4-2310-6460

ORDERING INFORMATION

Tooling

| Part Number | Description |
|-------------|---|
| 1309G4 | Hand tool, #16 to #6 |
| 1387G1 | Pneumatic tool, #16 to #6 |
| 1388G6 | - die for #16 to #6 AWG |
| 1388G7 | - die for #10 to #12 AWG (5914, 5915 & 5953 contacts) |
| 1389G6 | - locator for #16 to #6 AWG |
| 1389G7 | - locator for #10 to #12 AWG (5914, 5915 & 5953 contacts) |
| 260G16 | Applicator only (110V & 220V) |
| 284G1 | Applicator & Press (220V, 50Hz) |
| 250G5 | Press only (110V, 60Hz) |

DIMENSIONS

Housings

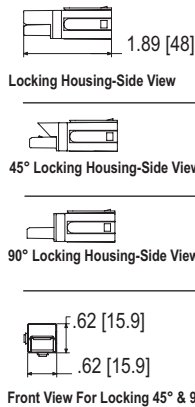

Mounting Wings

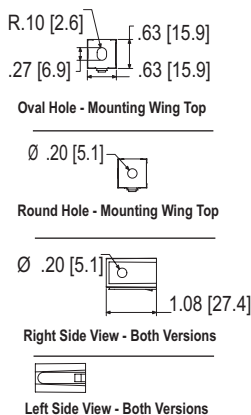

Surface Mount Pad

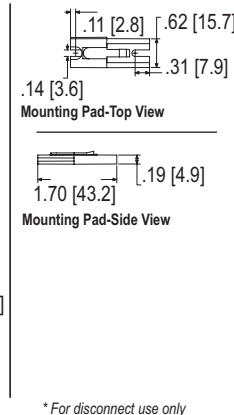

* For disconnect use only

Contacts

| Part Number | -A- | | -B- | | -C- | | -D- | | -E- | | -F- |
|-------------|------|------|------|------|-----|------|-------------|------|------|------|--------|
| | mm | in. | mm | in. | mm | in. | mm | in. | mm | in. | mm in. |
| 1307 | 30.0 | 1.18 | 7.2 | 0.28 | 5.6 | 0.22 | 11.4 | 0.45 | 7.1 | 0.28 | N/A |
| 5900 | 30.0 | 1.18 | 7.2 | 0.28 | 5.6 | 0.22 | 11.4 | 0.45 | 7.1 | 0.28 | N/A |
| 5914 | 29.7 | 1.17 | 4.8 | 0.19 | 3.5 | 0.14 | 11.4 | 0.45 | 7.1 | 0.28 | N/A |
| 5915 | 30.0 | 1.18 | 7.2 | 0.28 | 3.5 | 0.14 | 11.4 | 0.45 | 7.1 | 0.28 | N/A |
| 5952 | 30.0 | 1.18 | 7.2 | 0.28 | 4.7 | 0.19 | 11.4 | 0.45 | 7.1 | 0.28 | N/A |
| 5953 | 30.0 | 1.18 | 7.2 | 0.28 | 3.5 | 0.14 | 11.4 | 0.45 | 7.1 | 0.28 | N/A |
| 904G1 | 30.0 | 1.18 | 7.2 | 0.28 | 3.5 | 0.14 | 11.4 | 0.45 | 7.1 | 0.28 | N/A |
| 903G1 | 30.0 | 1.18 | 7.2 | 0.28 | 5.6 | 0.22 | 11.4 | 0.45 | 7.1 | 0.28 | N/A |
| 265G1 | 31.8 | 1.25 | 9.1 | 0.36 | 9.1 | 0.36 | 22.9 | 0.90 | 8.1 | 0.32 | N/A |
| 265G2 | 31.8 | 1.25 | 7.4 | 0.29 | 6.9 | 0.27 | 22.9 | 0.90 | 8.1 | 0.32 | N/A |
| 265G3 | 31.0 | 1.22 | 9.1 | 0.36 | 9.1 | 0.36 | 22.9 | 0.90 | 8.1 | 0.32 | N/A |
| 265G4 | 31.0 | 1.22 | 7.4 | 0.29 | 6.9 | 0.27 | 22.9 | 0.90 | 8.1 | 0.32 | N/A |
| 265G5 | 31.8 | 1.25 | 9.1 | 0.36 | 9.1 | 0.36 | 22.9 | 0.90 | 8.1 | 0.32 | N/A |
| 265G6 | 31.8 | 1.25 | 7.4 | 0.29 | 6.9 | 0.27 | 22.9 | 0.90 | 8.1 | 0.32 | N/A |
| 265G7 | 31.0 | 1.22 | 9.1 | 0.36 | 9.1 | 0.36 | 22.9 | 0.90 | 8.1 | 0.32 | N/A |
| 265G8 | 31.0 | 1.22 | 7.4 | 0.29 | 6.9 | 0.27 | 22.9 | 0.90 | 8.1 | 0.32 | N/A |
| 75BBS | 69.0 | 2.70 | 17.1 | 0.68 | 6.9 | 0.27 | #10-24 thd. | 1.0 | 0.04 | 2.0 | 0.08 |

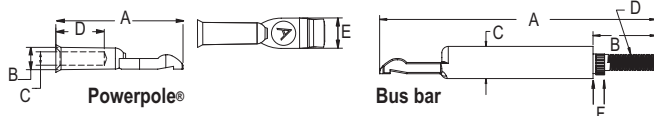

* See Bus Bar layout and mounting table on page 47



CSA Certified
File No. LR25154



File No. E26226

All Data Subject To Change Without Notice

TEMPERATURE RISE CHARTS

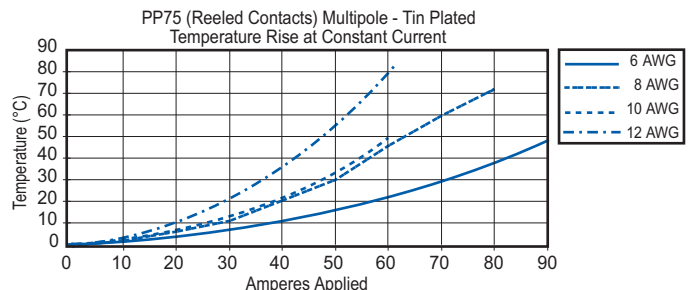
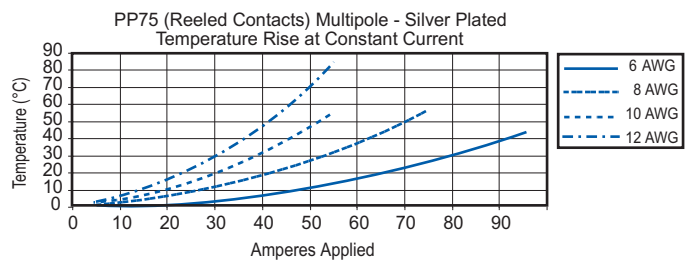
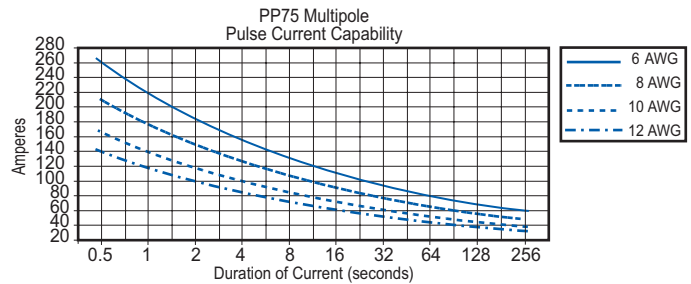
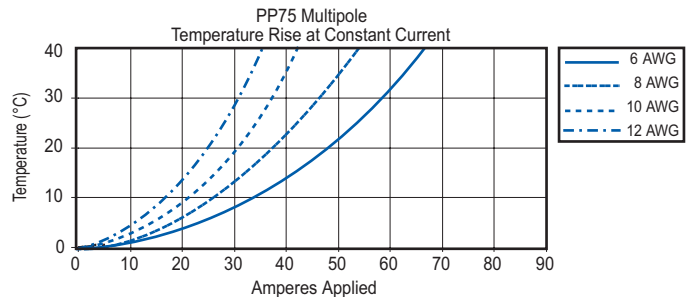
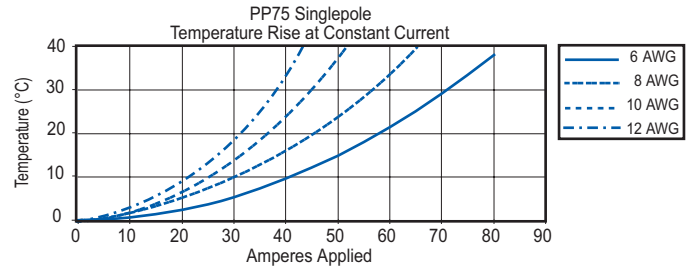

HEADQUARTERS: 13 Pratts Junction Road, P.O. Box 579, Sterling, MA 01564 T:978-422-3600 F:978-422-3700

EUROPE: Rathealy Road, Fermoy Co. Cork, Ireland T:353-(0)25-32277 F:353-(0)25-32296

ASIA/PACIFIC: IDEAL Anderson Asia Pacific Ltd., Unit 922-928 Topsail Plaza, 11 On Sum Street, Shatin N.T., Hong Kong T:852-2636-0836 F:852-2635-9036

CHINA: IDEAL Anderson Technologies (Shenzhen) Ltd., Block A8 Tantou W. Ind. Par, Songgang Baoan District, Shenzhen, PR. China 51810 T: 86-755-2768-2118 F: 86-755-2768-2218

TAIWAN: IDEAL Anderson Asia Pacific Ltd., Taiwan Branch, 4F-2, No.116, Dadun 20th St., Situn District, Taichung City 407, Taiwan (R.O.C.) T: 886-4-2310-6451 F:886-4-2310-6460

www.andersonpower.com

Powerpole® connectors provide cost-effective reliability, design flexibility and safety for your products' manufacture, installation and maintenance. Powerpoles are stackable and color-coded for easy customization into multipole blocks.

The housings are modular and genderless. Powerpole® connectors provide 600 Volts continuous AC or DC operation. Wire sizes range from #2 to #8 AWG (33.6 to 8.4 mm²).

FEATURES

- Flat wiping contact system**
Minimal contact resistance at high current, wiping action cleans contact surface during connection/disconnection
- Colored modular housings**
Provides visual identification of proper mating connector
- Molded-in dovetails**
Secures individual connectors into "keyed" assemblies which prevents misconnection with similar configurations



PRODUCT SPECIFICATIONS

| Connector Model | PP120 | Connector Model | PP120 |
|--|-------------|--|--------------|
| UL Current Rating (Amperes)* | 120* | Life | |
| UL Voltage Ratings (Volts)** | 600* | a. No load (Contact/Disconnect Cycles) | To 10,000 |
| Contact Barrel Wire Size (AWG) | #2 to #8 | b. Under Load (Hot Plug 250 cycles @ 120V) | 60A |
| (mm ²) | 33.6 to 8.4 | Avg. Connection/Disconnect (lbf) | 8 |
| Maximum Wire Insulation Diameter (inches) | 0.600 | Operating Temperature Range °C*** | -20° to 105° |
| (mm) | 15.24 | °F | -4° to 221° |
| AVG Contact Resistance* (micro-ohms) | 136 | Flammability Rating of Housing Material | UL94 V-0 |
| Insulation Withstanding Test Voltage (Volts AC/DC) | 2200 | | |
| Contact Retention Force (lbf) | 100 | | |



* UL Rated for 65°C largest wire or cable size
 ** Both AC & DC Voltage
 *** Contact factory for higher temperature rated connectors

ORDERING INFORMATION

Housing & 120 amp Contact

| Part Number | Housing Color | Wire | |
|-------------|---------------|------|--------|
| | | AWG | sq. mm |
| 1320 | Blue | #2 | 33.6 |
| 1320G1 | Black | #2 | 33.6 |
| 1320G2 | White | #2 | 33.6 |
| 1320G3 | Red | #2 | 33.6 |
| 1320G4 | Green | #2 | 33.6 |

120 amp Contacts

| Part Number | Description | Wire | |
|-------------|-------------|------|--------|
| | | AWG | sq. mm |
| 1319 | Individual | #2 | 33.6 |
| 1319G4 | Individual | #4 | 21.2 |
| 1319G6 | Individual | #6 | 13.3 |

Housings Only

| Part Number | Description |
|-------------|---------------|
| 1321 | Blue housing |
| 1321G1 | Black housing |
| 1321G2 | White housing |
| 1321G3 | Red housing |
| 1321G4 | Green housing |

Bushings

| Part Number | Description | Wire | |
|-------------|---------------|----------|-----------|
| | | AWG | sq. mm |
| 5919 | Use with 1319 | #2 to #4 | 33.6/21.2 |
| 5920 | Use with 1319 | #2 to #6 | 33.6/13.3 |
| 5921 | Use with 1319 | #2 to #8 | 33.6/8.4 |

Accessories

| Part Number | Description |
|-------------|--|
| 110G20 | Retaining Pins, 2 high block of connectors |
| 110G19 | Retaining Pins, 1 high block of connectors |

Tooling

| Part Number | Description |
|-------------|--------------------------|
| 1368 | Hydraulic tool, #2 to #8 |
| 1387G1 | Pneumatic tool, #2 to #8 |
| 1388G4 | - die for #2 to #8 |
| 1389G4 | - locator #2 to #8 |

Note: For additional colors please contact customer service

HEADQUARTERS: 13 Pratts Junction Road, P.O. Box 579, Sterling, MA 01564 T:978-422-3600 F:978-422-3700

EUROPE: Rathealy Road, Fermoy Co. Cork, Ireland T:353-(0)25-32277 F:353-(0)25-32296

ASIA/PACIFIC: IDEAL Anderson Asia Pacific Ltd., Unit 922-928 Topsail Plaza, 11 On Sum Street, Shatin N.T., Hong Kong T:852-2636-0836 F:852-2635-9036

CHINA: IDEAL Anderson Technologies (Shenzhen) Ltd., Block A8 Tantou W. Ind. Par, Songgang Baoan District, Shenzhen, PR. China 51810 T: 86-755-2768-2118 F: 86-755-2768-2218

TAIWAN: IDEAL Anderson Asia Pacific Ltd., Taiwan Branch, 4F.-2, No.116, Dadun 20th St., Situn District, Taichung City 407, Taiwan (R.O.C.) T: 886-4-2310-6451 F:886-4-2310-6460

www.andersonpower.com

DIMENSIONS

Housing

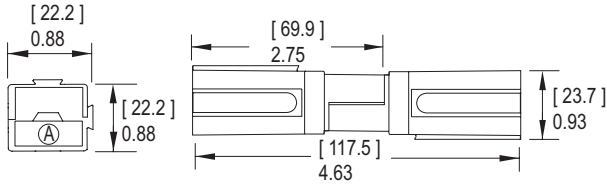

Contact

| Part Number | -A- | | -B- | | -C- | | -D- | | -E- | |
|-------------|------|------|------|------|-----|------|------|------|------|------|
| | mm | in. | mm | in. | mm | in. | mm | in. | mm | in. |
| 1319 | 50.8 | 2.00 | 11.1 | 0.44 | 8.7 | 0.34 | 21.6 | 0.85 | 10.4 | 0.41 |
| 1319G4 | 50.8 | 2.00 | 11.1 | 0.44 | 7.5 | 0.30 | 21.6 | 0.85 | 10.4 | 0.41 |
| 1319G6 | 50.8 | 2.00 | 11.1 | 0.44 | 5.6 | 0.22 | 21.6 | 0.85 | 10.4 | 0.41 |

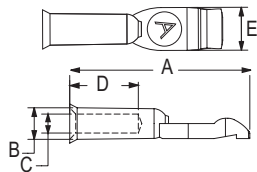

Mounting Clamps

| Part Number | -A- | | -B- | | -C- | | -D- | | -E- | | Number of Poles |
|-------------|------|------|------|------|------|------|------|------|-----|------|-----------------|
| | mm | in. | mm | in. | mm | in. | mm | in. | mm | in. | |
| 1464G1 | 60.5 | 2.38 | 47.7 | 1.88 | 38.1 | 1.50 | 44.5 | 1.75 | 4.0 | 0.16 | (2 Pole) |
| 1464G1 | 60.5 | 2.38 | 70.0 | 2.75 | 60.3 | 2.37 | 44.5 | 1.75 | 4.0 | 0.16 | (4 Pole) |
| 1464G2 | 82.6 | 3.25 | 47.7 | 1.88 | 38.1 | 1.50 | 66.7 | 2.63 | 4.0 | 0.16 | (3 Pole) |
| 1464G2 | 82.6 | 3.25 | 70.0 | 2.75 | 60.3 | 2.37 | 66.7 | 2.63 | 4.0 | 0.16 | (6 Pole) |

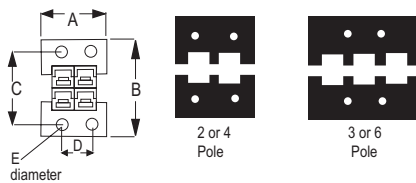

Bushings - (for use with 1319 contacts)

| Part Number | Reduces From | -A- | | -B- | | -C- | |
|-------------|--------------|------|-----|-----|-----|-----|-----|
| | | mm | in. | mm | in. | mm | in. |
| 5919 | #2 to #4 AWG | 21.4 | .84 | 8.4 | .33 | 7.2 | .29 |
| 5920 | #2 to #6 AWG | 21.4 | .84 | 8.4 | .33 | 5.8 | .23 |
| 5921 | #2 to #8 AWG | 21.4 | .84 | 8.4 | .33 | 4.6 | .18 |

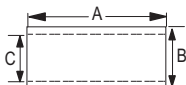

TEMPERATURE RISE CHARTS

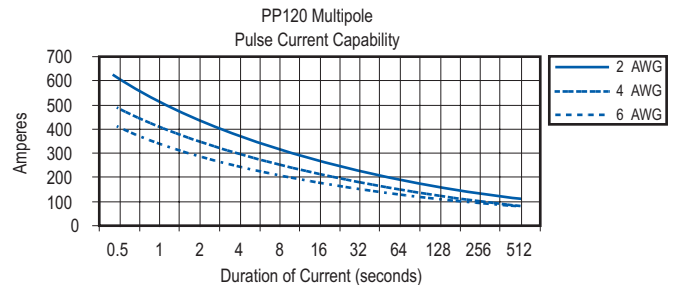
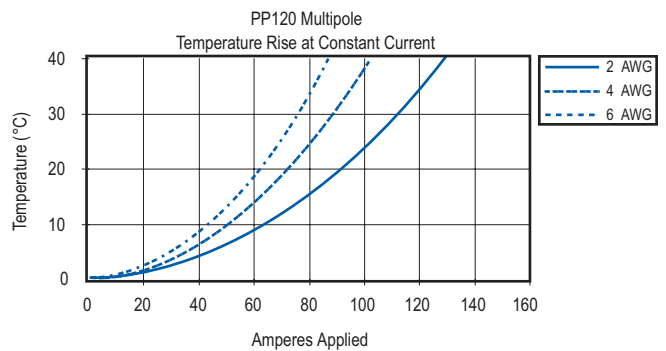
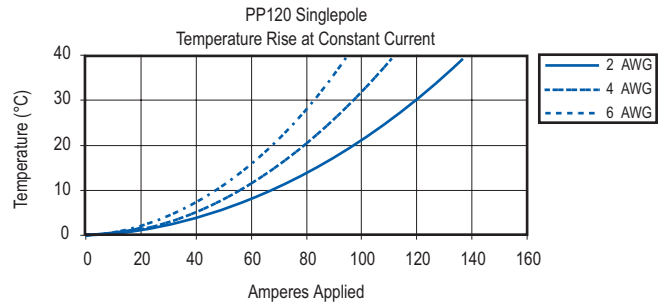

Powerpole® connectors provide cost-effective reliability, design flexibility and safety for your products' manufacture, installation and maintenance. Powerpoles are stackable and color-coded for easy customization into multipole blocks.

The housings are modular and genderless. Powerpole® connectors provide 600 Volts continuous, AC or DC operation. Wire sizes range from #1/0 to #10 AWG (53.5 to 5.3 mm²).

FEATURES

- Flat wiping contact system**
Minimal contact resistance at high current, wiping action cleans contact surface during connection/disconnection
- Colored modular housings**
Provides visual identification of proper mating connector
- Molded-in dovetails**
Secures individual connectors into "keyed" assemblies which prevents misconnection with similar configurations



PRODUCT SPECIFICATIONS

| Connector Model | PP180 | Connector Model | PP180 |
|--|-------------|--|--------------|
| UL Current Rating (Amperes)* | 180* | Life | |
| UL Voltage Ratings (Volts)** | 600* | a. No load (Contact/Disconnect Cycles) | To 10,000 |
| Contact Barrel Wire Size (AWG) | 1/0 to #10 | b. Under Load (Hot Plug 250 cycles @ 120V) | 75A |
| (mm ²) | 53.5 to 5.3 | Avg. Connection/Disconnect (lbf) | 20 |
| Maximum Wire Insulation Diameter (inches) | 0.900 | Operating Temperature Range °C*** | -20° to 105° |
| (mm) | 22.86 | °F | -4° to 221° |
| AVG Contact Resistance* (micro-ohms) | 100 | Flammability Rating of Housing Material | UL94 V-0 |
| Insulation Withstanding Test Voltage (Volts AC/DC) | 2200 | | |
| Contact Retention Force (lbf) | 170 | | |



* UL Rated for 65°C largest wire or cable size
 ** Both AC & DC Voltage
 *** Contact factory for higher temperature rated connectors

ORDERING INFORMATION

Housing & 180 amp Contact

| Part Number | Housing Color | Wire | |
|-------------|---------------|------|--------|
| | | AWG | sq. mm |
| 1380 | Blue | 1/0 | 53.5 |
| 1380G1 | Black | 1/0 | 53.5 |
| 1380G2 | White | 1/0 | 53.5 |
| 1380G3 | Red | 1/0 | 53.5 |
| 1380G4 | Green | 1/0 | 53.5 |

180 amp Contacts

| Part Number | Description | Wire | |
|-------------|-----------------|------|--------|
| | | AWG | sq. mm |
| 1347 | Individual | #1 | 42.4 |
| 1348* | Individual | #6 | 13.3 |
| 1382 | Individual | 1/0 | 53.5 |
| 1383 | Individual | #2 | 33.6 |
| 1384 | Individual | #4 | 21.2 |
| 180BBS | Bus bar contact | NA | NA |

* thin wall contact

Housings Only

| Part Number | Description |
|-------------|---------------|
| 1381 | Blue housing |
| 1381G1 | Black housing |
| 1381G2 | White housing |
| 1381G3 | Red housing |
| 1381G4 | Green housing |

Bushings

| Part Number | Description | Wire | |
|-------------|---------------|------------|-----------|
| | | AWG | sq. mm |
| 5648 | Use with 1382 | 1/0 to #10 | 53.5/5.1 |
| 5663 | Use with 1382 | 1/0 to #6 | 53.5/13.3 |
| 5687 | Use with 1382 | 1/0 to #1 | 53.5/42.4 |
| 5690 | Use with 1382 | 1/0 to #2 | 53.5/33.6 |
| 5693 | Use with 1382 | 1/0 to #4 | 53.5/21.2 |

Accessories

| Part Number | Description |
|-------------|--|
| 110G18 | Retaining Pins, 1 high block of connectors |
| 110G20 | Retaining Pins, 2 high block of connectors |
| 10G56 | Keeps nut for use with Bus bar contact |
| 1465G1 | 2 & 4 pole mounting clamp set |
| 1465G2 | 3 & 6 pole mounting clamp set |

Tooling

| Part Number | Description |
|-------------|---------------------------------|
| 1368 | Hydraulic tool |
| 1387G1 | Pneumatic tool, #10 to 1/0 |
| 1388G3 | - die for #10 to 1/0 |
| 1388G5 | - die for #4 (1382 contact) |
| 1389G3 | - locator for #10 to 1/0 |
| 1389G5 | - locator for #4 (1382 contact) |

Note: For additional colors please contact customer service

HEADQUARTERS: 13 Pratts Junction Road, P.O. Box 579, Sterling, MA 01564 T:978-422-3600 F:978-422-3700

EUROPE: Rathealy Road, Fermoy Co. Cork, Ireland T:353-(0)25-32277 F:353-(0)25-32296

ASIA/PACIFIC: IDEAL Anderson Asia Pacific Ltd., Unit 922-928 Topsail Plaza, 11 On Sum Street, Shatin N.T., Hong Kong T:852-2636-0836 F:852-2635-9036

CHINA: IDEAL Anderson Technologies (Shenzhen) Ltd., Block A8 Tantou W. Ind. Par, Songgang Baoan District, Shenzhen, P.R. China 51810 T: 86-755-2768-2118 F: 86-755-2768-2218

TAIWAN: IDEAL Anderson Asia Pacific Ltd., Taiwan Branch, 4F-2, No.116, Dadun 20th St., Situn District, Taichung City 407, Taiwan (R.O.C.) T: 886-4-2310-6451 F:886-4-2310-6460

www.andersonpower.com

DIMENSIONS

Housing

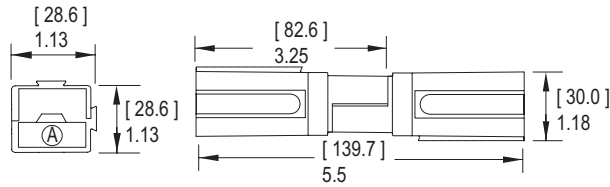

Contacts

| Part Number | -A- | -B- | -C- | -D- | -E- | -F- |
|-------------|-----------|-----------|-----------|------------|-----------|----------|
| | mm in. | mm in. | mm in. | mm in. | mm in. | mm in. |
| 1347 | 59.8 2.35 | 13.0 0.51 | 9.9 0.39 | 26.4 1.04 | 12.7 0.50 | N/A |
| 1348 | 53.3 2.10 | 9.3 0.37 | 5.6 0.22 | 20.3 0.80 | 12.7 0.50 | N/A |
| 1382 | 59.6 2.35 | 13.1 0.52 | 11.2 0.44 | 27.2 1.07 | 12.7 0.50 | N/A |
| 1383 | 59.7 2.35 | 13.2 0.52 | N/A | N/A | 12.7 0.50 | N/A |
| 1384 | 59.7 2.35 | 13.0 0.51 | 7.5 0.30 | 26.4 1.04 | 12.7 0.50 | N/A |
| 180BBS | 109.7 4.3 | 25.4 1.0 | 2.7 0.50 | N/A 1/4-20 | N/A | 4.6 0.18 |

Powerpole®

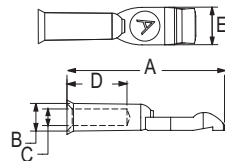

Bus bar

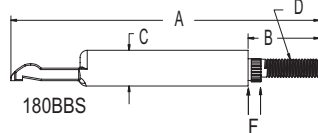

Bus Bar Layout

| Part Number | -J- | -K- | -L- | -M- |
|-------------|-----------|---------------------|------------|------------|
| | mm in. | mm in. | mm in. | mm in. |
| 180BBS | 26.8 1.05 | 26.8(min) 1.05(min) | 9.53 0.375 | 3.43 0.135 |

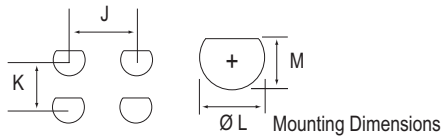

Bus bar Mounting Table

| Series | -G- | -H- |
|--------|--------------|-------------|
| | mm in. | mm in. |
| PP180 | 89.8 3.5 ref | 3.9 0.2 ref |

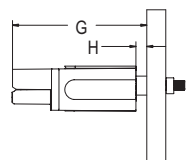

TEMPERATURE RISE CHARTS

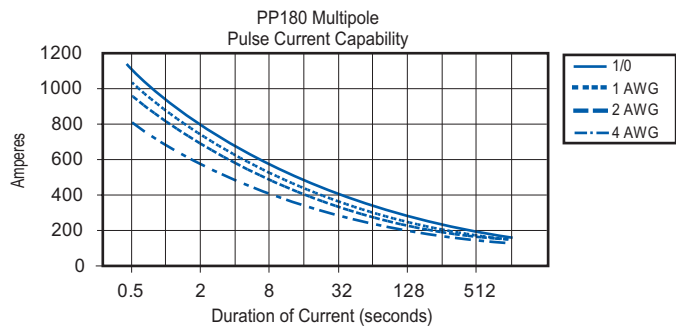
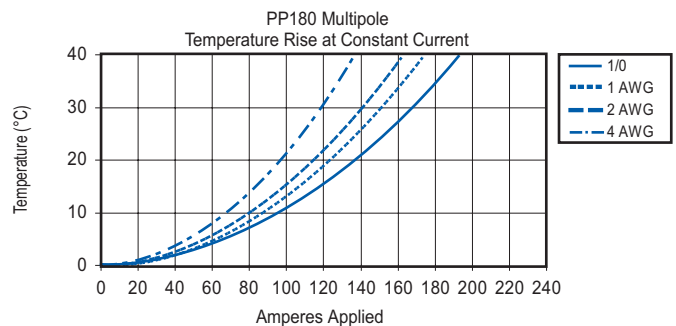
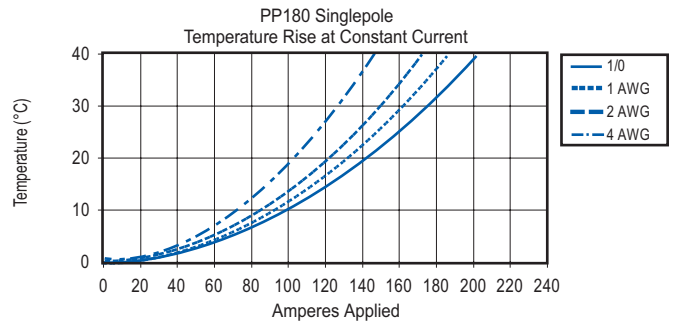

Mounting Clamps

| Part Number | -A- | -B- | -C- | -D- |
|-------------|------------|-----------|-----------|-----------|
| | mm in. | mm in. | mm in. | mm in. |
| 1465G1 | 71.4 2.81 | 55.7 2.19 | 43.0 1.69 | 28.6 1.13 |
| 1465G1 | 71.4 2.81 | 84.4 3.32 | 71.7 2.82 | 28.6 1.13 |
| 1465G2 | 100.8 3.97 | 55.7 2.19 | 43.0 1.69 | 57.2 2.25 |
| 1465G2 | 100.8 3.97 | 84.4 3.32 | 71.7 2.82 | 57.2 2.25 |

| Part Number | -E- | Number of Poles |
|-------------|----------|-----------------|
| 1465G1 | 4.8 0.19 | (2 Pole) |
| 1465G1 | 4.8 0.19 | (4 Pole) |
| 1465G2 | 4.8 0.19 | (3 Pole) |
| 1465G2 | 4.8 0.19 | (6 Pole) |

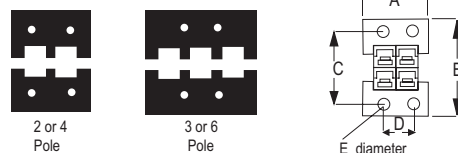



Connector Notes

For customer drawings, assembly instructions and individual data sheets, please visit www.andersonpower.com.

FEATURES

- **Vertical and right angle terminations**
Allows for design flexibility
- **Tin plated copper contacts**
Minimal contact resistance at high currents
- **Fits standard housing & accessories**
Allows for configurations that can be color coded & polarized
- **Two right angle stacking bends**
Allows two rows parallel stacking of connectors on the PCB
- **Quick disconnect**
Avoids the need for unfastening ring type terminals
- **Snap-On interface**
Ensures foolproof assembly and proper connection
- **Vertical mini-powerclaw UL rated**
For current interruption (hot-plug) so that equipment can be hot swapped
- **Anti-static packaging**
Meets electronics industry PCB requirements
- **Vacuum packaging**
Prevents tarnishing of contacts during shelf life

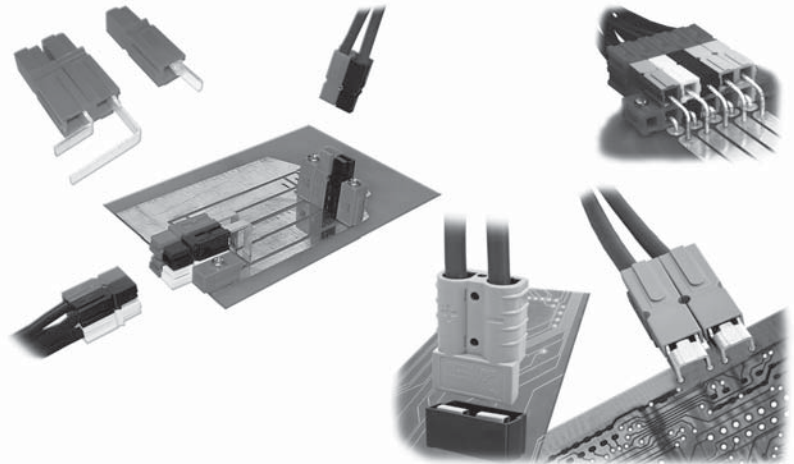

PRODUCT RANGE

| | |
|---|----------------------|
| UL Current Rating (Amperes)* | 25 to 55 |
| UL Voltage Ratings (Volts) | 600 |
| Housing Material | Polycarbonate |
| Contact Material | Copper Alloy |
| Contact Plating | Tin or Silver |
| Mating/Unmating Forces | 2 to 15 lbf. |
| Suggested Board Thickness | 0.093 to 0.150" max. |
| Operating Temperature Range °C** | -20° to 105° |
| °F | -4° to 221° |
| Flammability Rating of Housing Material | UL94 V-0 |



* See Temperature Rise Chart

** Contact factory for higher temperature rated connectors

PRODUCT INFORMATION

The printed circuit board (PCB) contact series, when utilized with the Powerpole® 15/45, PP75 and SB@50 connector housings, provides a reliable wire to printed circuit board connection. It's rated at 25 to 55 amps, 600 volts, AC/DC. This contact is available in both straight (vertical) and right angle (horizontal) terminations for perpendicular and parallel mounting.

The innovative design of our PCB family of connectors for the power electronics market makes connecting and disconnecting a snap, enabling safe and convenient "hot swapping*" during equipment maintenance without the need to power down. Compact and robust, they're rated at 55 amps for singlepole and 50 amps for blocked connections.

Our mini horizontal and vertical PCB contacts offer the same high current capacity as our original, while providing the design engineer more options when board real estate is at a minimum.

* Contact factory for ratings



Powerpole® 1327,
1345 and 1330 series



CSA Certified
File No. LR25154



File No. E26226 PCB: Patent No. 5,458,510 All Data Subject To Change Without Notice

HEADQUARTERS: 13 Pratts Junction Road, P.O. Box 579, Sterling, MA 01564 T:978-422-3600 F:978-422-3700

EUROPE: Rathealy Road, Fermoy Co. Cork, Ireland T:353-(0)25-32277 F:353-(0)25-32296

ASIA/PACIFIC: IDEAL Anderson Asia Pacific Ltd., Unit 922-928 Topsail Plaza, 11 On Sum Street, Shatin N.T., Hong Kong T:852-2636-0836 F:852-2635-9036

CHINA: IDEAL Anderson Technologies (Shenzhen) Ltd., Block A8 Tantou W. Ind. Par, Songgang Baoan District, Shenzhen, P.R. China 51810 T: 86-755-2768-2118 F: 86-755-2768-2218

TAIWAN: IDEAL Anderson Asia Pacific Ltd., Taiwan Branch, 4F.-2, No.116, Dadun 20th St., Situn District, Taichung City 407, Taiwan (R.O.C.) T: 886-4-2310-6451 F:886-4-2310-6460

www.andersonpower.com

Anderson Power Products® printed circuit board (PCB) contact series, when utilized with the Powerpole® 15/45 connector housings, provides a reliable wire to printed circuit board connection. They are rated at 25 amps, 600 volts, AC/DC. This contact is available in both straight and right angle terminations for perpendicular and parallel mounting and is ideal for all applications that require high current connections to the PCB.

FEATURES

- **Straight & right angle terminals**

Flexibility of parallel or perpendicular mounting to the PCB

- **Tin plated copper contacts**

Minimal contact resistance at high currents

- **Fits standard housing & accessories**

Allows for configurations that can be color coded & polarized

- **Two level right angle contacts**

Dual level right angle powerpole assemblies provide high power density

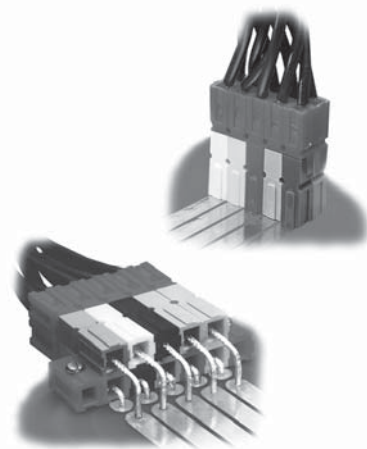

PRODUCT SPECIFICATIONS

| | | | |
|--|-------------------------|------------------|---|
| Connector Model | 25A PCB | PCB traces | See temperature curve or contact the factory |
| Current rating for a single mated pair | 25 amps * | Housing material | Polycarbonate 94 V-0(Max. op. temp. = 105°C / 221°F) |
| Maximum operating voltage AC/DC | 600 volts | | Operating temp. = ambient temp. + temp. rise at current |
| Contact material | Tin plated copper alloy | | |
| PCB hole (inches) | .070 hole | | |
| PCB hole (mm) | 1.80 | | |



* See Temperature Rise Chart. Based on 0.002 in² copper foil on PCB & 12AWG wire cross-section.

ORDERING INFORMATION

25 amp Right Angle PCB Contact*

| Part Number | Description | Contact Length in. | sq. mm |
|-------------|------------------|--------------------|--------|
| 1377G1 | Right Angle - LD | 0.70 | 17.8 |
| 1377G2 | Right Angle - LD | 0.40 | 10.2 |
| 1377G11 | Right Angle - LD | 0.70 | 17.8 |
| 1377G12 | Right Angle - LD | 0.40 | 10.2 |
| 1377G14 | Right Angle - LD | 0.18 | 4.6 |
| 1377G15 | Right Angle - LD | 1.02 | 25.9 |
| 1377G16 | Right Angle - LD | 0.72 | 18.3 |
| 1377G17 | Right Angle - LD | 0.88 | 22.4 |
| 1377G18 | Right Angle - LD | 0.58 | 14.7 |
| 1317G1 | Right Angle - HD | 0.70 | 17.8 |
| 1317G2 | Right Angle - HD | 0.40 | 10.2 |
| 1317G11 | Right Angle - HD | 0.70 | 17.8 |
| 1317G14 | Right Angle - HD | 0.18 | 4.6 |
| 1317G15 | Right Angle - HD | 1.02 | 25.9 |
| 1317G16 | Right Angle - HD | 0.72 | 18.3 |
| 1317G17 | Right Angle - HD | 0.88 | 22.4 |
| 1317G18 | Right Angle - HD | 0.58 | 14.7 |

25 amp Straight PCB Contact*

| Part Number | Description | Contact Length in. | sq. mm |
|-------------|------------------------|--------------------|--------|
| 1377G3 | Straight Terminal - LD | 2.16 | 54.9 |
| 1377G4 | Straight Terminal - LD | 1.7 | 43.2 |
| 1377G13 | Straight Terminal - LD | 1.11 | 28.2 |
| 1317G3 | Straight Terminal - HD | 2.16 | 54.9 |
| 1317G4 | Straight Terminal - HD | 2.16 | 43.2 |
| 1317G13 | Straight Terminal - HD | 1.11 | 28.2 |

Housings Only

| Part Number | Description |
|-------------|----------------|
| 1327 | Red housing |
| 1327G5 | Green housing |
| 1327G6 | Black housing |
| 1327G7 | White housing |
| 1327G8 | Blue housing |
| 1327G16 | Yellow housing |

housings only continued

| Part Number | Description |
|-------------|----------------|
| 1327G17 | Orange housing |
| 1327G18 | Gray housing |
| 1327G21 | Brown housing |
| 1327G22 | Pink housing |
| 1327G23 | Purple housing |

Accessories

| Part Number | Description |
|-------------|--------------------------------|
| 1399G9 | Red mounting wing |
| 1399G8 | Blue mounting wing |
| 1399G1** | Red short spacer with end hole |
| 1399G2** | Red long spacer |
| 1399G6** | Red short spacer without hole |
| 110G68 | PP15/45 retention clip |
| 114555P1 | Staple 1x1 (H x W) |
| 114555P2 | Staple 1x2 (H x W) |
| 114555P3 | Staple 1x3 (H x W) |
| 114555P7 | Staple 1x4 (H x W) |
| 114555P8 | Staple 1x6 (H x W) |
| 114555P5 | Staple 2x1 (H x W) |
| 114555P6 | Staple 2x2 (H x W) |
| 114555P9 | Staple 2x2 - long (H x W) |

* LD - low detent or HD - high detent

** Contact customer service for additional colors

Note: For additional colors please contact customer service. For finger proof housings see page 18.

HEADQUARTERS: 13 Pratts Junction Road, P.O. Box 579, Sterling, MA 01564 T:978-422-3600 F:978-422-3700

EUROPE: Rathealy Road, Fermoy Co. Cork, Ireland T:353-(0)25-32277 F:353-(0)25-32296

ASIA/PACIFIC: IDEAL Anderson Asia Pacific Ltd., Unit 922-928 Topsail Plaza, 11 On Sum Street, Shatin N.T., Hong Kong T:852-2636-0836 F:852-2635-9036

CHINA: IDEAL Anderson Technologies (Shenzhen) Ltd., Block A8 Tantou W. Ind. Par, Songgang Baoan District, Shenzhen, PR. China 51810 T: 86-755-2768-2118 F: 86-755-2768-2218

TAIWAN: IDEAL Anderson Asia Pacific Ltd., Taiwan Branch, 4F-2, No.116, Dadun 20th St., Situn District, Taichung City 407, Taiwan (R.O.C.) T: 886-4-2310-6451 F:886-4-2310-6460

www.andersonpower.com

DIMENSIONS

Straight Terminals

| Part Number | -C- | | -E- | |
|-------------|------|------|------|------|
| | mm | in. | mm | in. |
| 1377G3 | 54.9 | 2.16 | 56.4 | 2.22 |
| 1377G4 | 43.2 | 1.70 | 44.7 | 1.76 |
| 1317G3 | 54.9 | 2.16 | 56.4 | 2.22 |
| 1317G4 | 43.2 | 2.16 | 44.7 | 1.76 |
| 1377G13 | 28.2 | 1.11 | 29.7 | 1.17 |
| 1317G13 | 28.2 | 1.11 | 29.7 | 1.17 |

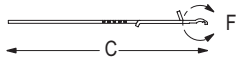

Low Detent Contact, Straight Terminal

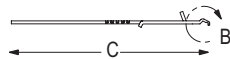

High Detent Contact, Straight Terminal



Low Detent Contact, Bent or Straight



High Detent Contact, Bent or Straight

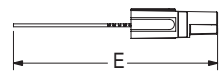

Straight Terminal Inside a Housing



PCB Center Line

| -A- | -B- | -C- | -D- | -E- | -F- | -G- |
|---------|---------|----------|---------|----------|-----------|----------|
| mm in. | mm in. | mm in. | mm in. | mm in. | mm in. | mm in. |
| 7.9 .31 | 7.9 .31 | 24.7 .97 | 8.4 .33 | 16.3 .64 | 34.5 1.36 | 13.7 .54 |

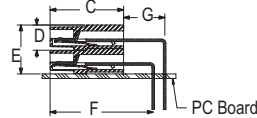
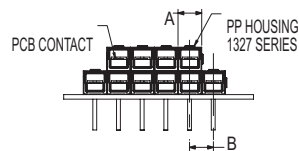

Housing

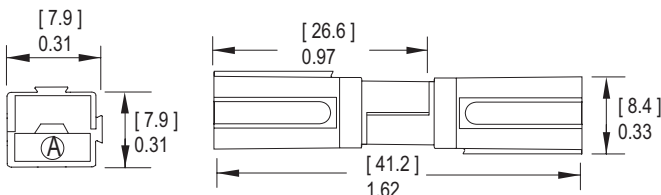

TEMPERATURE RISE CHART

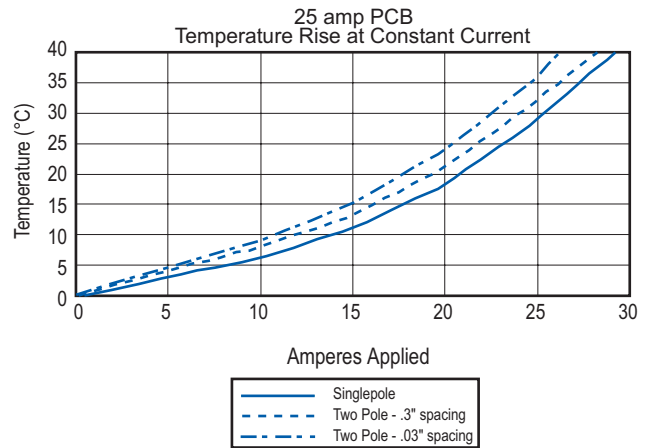

Note: Based on 0.002 in² copper foil on PCB & 12AWG wire cross-section.

Right Angle Contacts

| Part Number | -A- | | -B- | | -D- | |
|-------------|------|------|------|------|------|------|
| | mm | in. | mm | in. | mm | in. |
| 1377G1 | 36.8 | 1.46 | 17.8 | 0.70 | 38.6 | 1.52 |
| 1377G2 | 33.0 | 1.30 | 10.2 | 0.40 | 34.5 | 1.36 |
| 1377G11 | 29.0 | 1.14 | 17.8 | 0.70 | 30.7 | 1.21 |
| 1377G12 | 24.2 | 0.95 | 10.2 | 0.40 | 25.7 | 1.01 |
| 1377G14 | 33.0 | 1.30 | 4.6 | 0.18 | 34.5 | 1.36 |
| 1377G15 | 29.0 | 1.14 | 25.9 | 1.02 | 30.7 | 1.21 |
| 1377G16 | 24.1 | 0.95 | 18.3 | 0.72 | 25.4 | 1.00 |
| 1377G17 | 29.0 | 1.14 | 22.4 | 0.88 | 30.7 | 1.21 |
| 1377G18 | 25.4 | 1.00 | 14.7 | 0.58 | 27.2 | 1.07 |
| 1317G1 | 36.8 | 1.46 | 17.8 | 0.70 | 38.6 | 1.52 |
| 1317G2 | 33.0 | 1.30 | 10.2 | 0.40 | 34.5 | 1.36 |
| 1317G11 | 29.0 | 1.14 | 17.8 | 0.70 | 30.7 | 1.21 |
| 1317G14 | 33.0 | 1.30 | 4.6 | 0.18 | 34.5 | 1.36 |
| 1317G15 | 29.0 | 1.14 | 25.9 | 1.02 | 30.7 | 1.21 |
| 1317G16 | 24.1 | 0.95 | 18.3 | 0.72 | 25.4 | 1.00 |
| 1317G17 | 29.0 | 1.14 | 22.4 | 0.88 | 30.7 | 1.21 |
| 1317G18 | 25.4 | 1.00 | 14.7 | 0.58 | 27.2 | 1.07 |

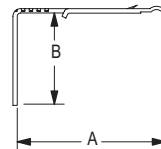

Right Angle Contact Without a Housing

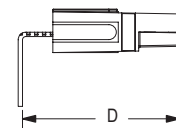

Right Angle Contact With a Housing

Staple

| Part Number | H x W | -A- | | -B- | |
|-------------|------------|------|-------|------|-------|
| | | mm | in. | mm | in. |
| 114555P1 | 1x1 | 12.0 | 0.472 | 6.0 | 0.236 |
| 114555P2 | 1x2 | 12.0 | 0.472 | 13.5 | 0.531 |
| 114555P3 | 1x3 | 12.0 | 0.472 | 21.5 | 0.846 |
| 114555P7 | 1x4 | 12.0 | 0.472 | 29.5 | 1.161 |
| 114555P8 | 1x6 | 12.0 | 0.472 | 45.5 | 1.791 |
| 114555P5 | 2x1 | 20.0 | 0.787 | 6.0 | 0.236 |
| 114555P6 | 2x2 | 20.0 | 0.787 | 13.5 | 0.531 |
| 114555P9 | 2x2 (long) | 23.0 | 0.905 | 13.5 | 0.531 |

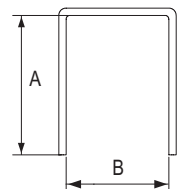

File No. E26226 PCB: Patent No. 5,458,510

All Data Subject To Change Without Notice

HEADQUARTERS: 13 Pratts Junction Road, P.O. Box 579, Sterling, MA 01564 T:978-422-3600 F:978-422-3700

EUROPE: Rahealy Road, Fermoy Co. Cork, Ireland T:353-(0)25-32277 F:353-(0)25-32296

ASIA/PACIFIC: IDEAL Anderson Asia Pacific Ltd., Unit 922-928 Topsail Plaza, 11 On Sum Street, Shatin N.T., Hong Kong T:852-2636-0836 F:852-2635-9036

CHINA: IDEAL Anderson Technologies (Shenzhen) Ltd., Block A8 Tantou W. Ind. Par, Songgang Baoan District, Shenzhen, P.R. China 51810 T: 86-755-2768-2118 F: 86-755-2768-2218

TAIWAN: IDEAL Anderson Asia Pacific Ltd., Taiwan Branch, 4F-2, No.116, Dadun 20th St., Situn District, Taichung City 407, Taiwan (R.O.C.) T: 886-4-2310-6451 F:886-4-2310-6460

www.andersonpower.com

Anderson Power Products High Current printed circuit board (PCB) contact series, when utilized with the Powerpole® 15/45 connector housings, provides a reliable wire to PCB connection. They are UL Recognized at 45 amps, AC or DC. The connector may be configured in 1 and 2 row configurations, in both vertical and right angle mounted terminations. This connector provides an ideal solution for applications that require high current connections to a PCB.

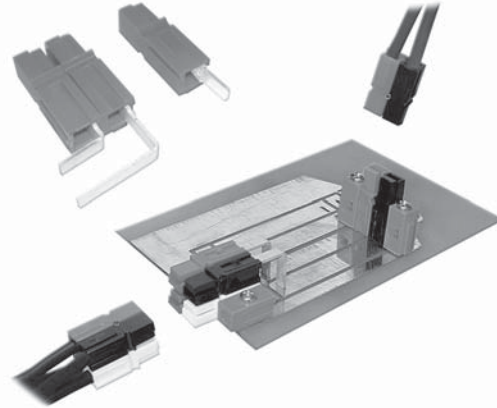

FEATURES

- **Current rating 45 amps**
Enables high current connections directly to the PCB
- **Vertical and right angle terminations**
Allows for design flexibility
- **High durability**
 - Rated up to 1,500 cycles (no load)
 - Under Load (Hot Plug 250 cycles @ 120V)
- **Offered in pre-assembled 1 and 2 row configurations (See Ordering Information)**
 - Reduces assembly costs of housings and contacts
 - Pre-assembled configurations prevent accidental separation of housings
- **Individual housings and contacts also sold separately**
 - Allows for customization of configurations
 - Allows for color coding of housings to wires for ease of manufacturing

PRODUCT SPECIFICATIONS

| | | | |
|---|---|--------------------------|----------------------------|
| UL Current Rating For Single Mated Pair | 45 amps (for others see rating curves)* | PCB Thickness - in. [mm] | 0.093 [2.4] - 0.125 [3.2] |
| Max Recommended Voltage - (per IEC 60950-1) | 150V (pollution degree 3) - 250V (pollution degree 2) | Contact Material | Tin plating copper alloy |
| Minimum Creepage | 2.8mm | Housing Material | Polycarbonate 94 V-0 rated |
| Voltage Drop For Mated Pair | ≤ 2.50 mV | | |
| Connector Mating Force For Mated Pair | 2 - 3 Lbf. | | |
| PCB Footprint | See following page | | |



* See Temperature Rise Chart

ORDERING INFORMATION

High Power Connector

| Part Number | Description |
|-------------|---|
| PP45PC12S | 1x2 vertical mount, short tail, black housing |
| PP45PC13S | 1x3 vertical mount, short tail, black housing |
| PP45PC12R | 1x2 horizontal, single row, right angle tail, black housing |
| PP45PC13R | 1x3 horizontal, single row, right angle tail, black housing |
| PP45PC21R | 2x1 horizontal, dual row, right angle tail, black housing |
| PP45PC22R | 2x2 horizontal, dual row, right angle tail, black housing |
| PP45PC23R | 2x3 horizontal, dual row, right angle tail, black housing |

High Power Contact

| Part Number | Description |
|-------------|--|
| 1335G1 | Vertical mount, short tail contact |
| 1336G1 | Horizontal (Bottom), right angle mount |
| 1337G1 | Horizontal (Top), right angle mount |

Housings Only

| Part Number | Description |
|-------------|----------------|
| 1327 | Red housing |
| 1327G5 | Green housing |
| 1327G6 | Black housing |
| 1327G7 | White housing |
| 1327G8 | Blue housing |
| 1327G16 | Yellow housing |
| 1327G17 | Orange housing |
| 1327G18 | Gray housing |
| 1327G21 | Brown housing |
| 1327G22 | Pink housing |
| 1327G23 | Purple housing |

Accessories

| Part Number | Description |
|-------------|--------------------------------|
| 1399G9 | Red mounting wing |
| 1399G8 | Blue mounting wing |
| 1399G1 | Red short spacer with end hole |
| 1399G2 | Red long spacer |
| 1399G6 | Red short spacer without hole |
| 110G68 | PP15/45 retention clip |
| 114555P1 | Staple 1x1 (H x W) |
| 114555P2 | Staple 1x2 (H x W) |
| 114555P3 | Staple 1x3 (H x W) |
| 114555P7 | Staple 1x4 (H x W) |
| 114555P8 | Staple 1x6 (H x W) |
| 114555P5 | Staple 2x1 (H x W) |
| 114555P6 | Staple 2x2 (H x W) |
| 114555P9 | Staple 2x2 - long (H x W) |

Note: For additional colors please contact customer service. For finger proof housings see page 18.

HEADQUARTERS: 13 Pratts Junction Road, P.O. Box 579, Sterling, MA 01564 T:978-422-3600 F:978-422-3700

EUROPE: Rathealy Road, Fermoy Co. Cork, Ireland T:353-(0)25-32277 F:353-(0)25-32296

ASIA/PACIFIC: IDEAL Anderson Asia Pacific Ltd., Unit 922-928 Topsail Plaza, 11 On Sum Street, Shatin N.T., Hong Kong T:852-2636-0836 F:852-2635-9036

CHINA: IDEAL Anderson Technologies (Shenzhen) Ltd., Block A8 Tantou W. Ind. Par, Songgang Baoan District, Shenzhen, PR. China 51810 T: 86-755-2768-2118 F: 86-755-2768-2218

TAIWAN: IDEAL Anderson Asia Pacific Ltd., Taiwan Branch, 4F.-2, No.116, Dadun 20th St., Situn District, Taichung City 407, Taiwan (R.O.C.) T: 886-4-2310-6451 F:886-4-2310-6460

www.andersonpower.com

DIMENSIONS

Straight Terminal

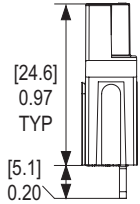

Right Angle Terminal

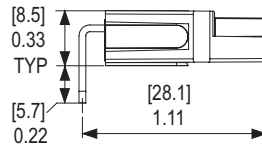

Right Angle Terminal 2 High

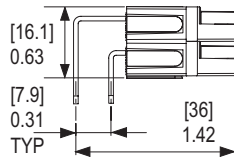

Typical Contact Orientation

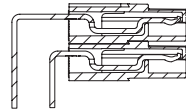

Blocked Housings 2 x 2

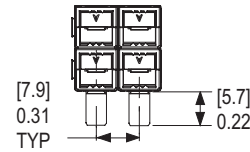

Footprint

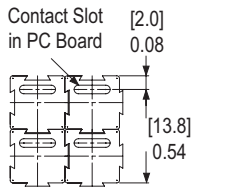

Multipole Vertical Mount Connector Typical Placement

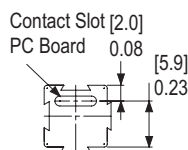

Singlepole Vertical Mount Connector Typical Placement

Staple

| Part Number | H x W | - A - | | - B - | |
|-------------|------------|-------|-------|-------|-------|
| | | mm | in. | mm | in. |
| 114555P1 | 1x1 | 12.0 | 0.472 | 6.0 | 0.236 |
| 114555P2 | 1x2 | 12.0 | 0.472 | 13.5 | 0.531 |
| 114555P3 | 1x3 | 12.0 | 0.472 | 21.5 | 0.846 |
| 114555P7 | 1x4 | 12.0 | 0.472 | 29.5 | 1.161 |
| 114555P8 | 1x6 | 12.0 | 0.472 | 45.5 | 1.791 |
| 114555P5 | 2x1 | 20.0 | 0.787 | 6.0 | 0.236 |
| 114555P6 | 2x2 | 20.0 | 0.787 | 13.5 | 0.531 |
| 114555P9 | 2x2 (long) | 23.0 | 0.905 | 13.5 | 0.531 |

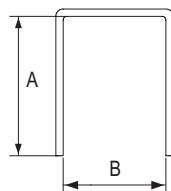

TEMPERATURE RISE CHART

PP45PC- Series Heat Rise
Mounted on #10 AWG Equivalent Traces
Mated with 261G2 Contact / #10 AWG

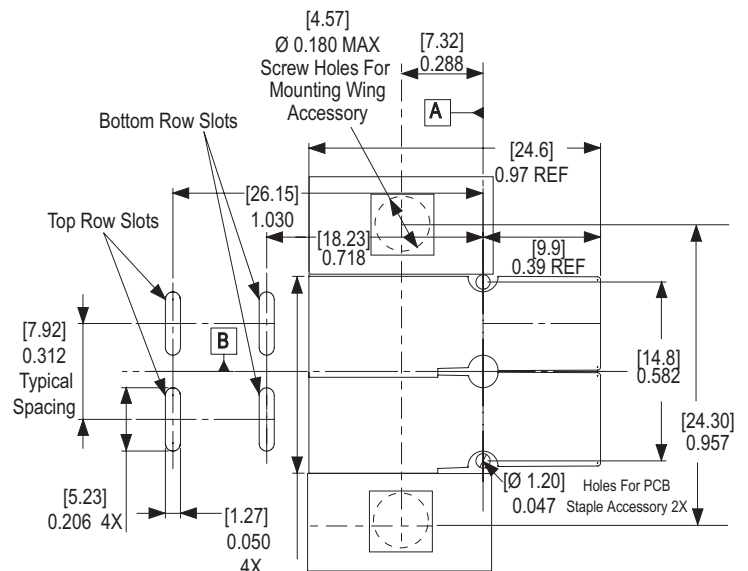
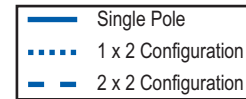
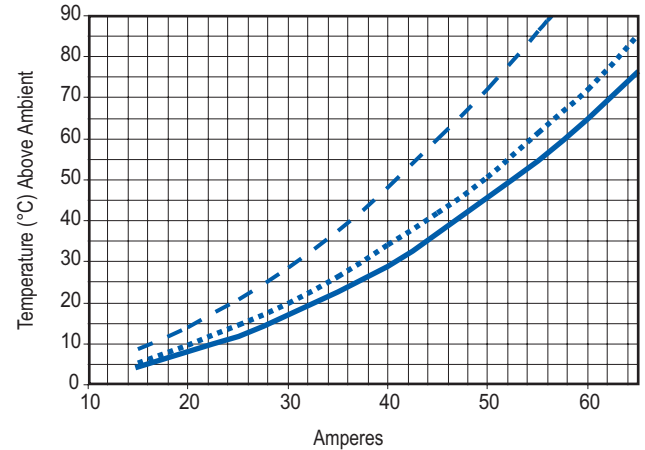

CSA Certified
File No. LR25154



File No. E26226

All Data Subject To Change Without Notice

HEADQUARTERS: 13 Pratts Junction Road, P.O. Box 579, Sterling, MA 01564 T:978-422-3600 F:978-422-3700

EUROPE: Rathely Road, Fermoy Co. Cork, Ireland T:353-(0)25-32277 F:353-(0)25-32296

ASIA/PACIFIC: IDEAL Anderson Asia Pacific Ltd., Unit 922-928 Topsail Plaza, 11 On Sum Street, Shatin N.T., Hong Kong T:852-2636-0836 F:852-2635-9036

CHINA: IDEAL Anderson Technologies (Shenzhen) Ltd., Block A8 Tantou W. Ind. Par, Songgang Baoan District, Shenzhen, P.R. China 51810 T: 86-755-2768-2118 F: 86-755-2768-2218

TAIWAN: IDEAL Anderson Asia Pacific Ltd., Taiwan Branch, 4F.-2, No.116, Dadun 20th St., Situn District, Taichung City 407, Taiwan (R.O.C.) T: 886-4-2310-6451 F:886-4-2310-6460

www.andersonpower.com

The innovative design of our Powerclaw® family of connectors for the power electronics market makes connecting and disconnecting a snap, enabling safe and convenient "hot swapping" during equipment maintenance without the need to power down. Compact and robust, they're rated at 55 amps for single pole and 50 amps for multipole connections.

Our mini horizontal and vertical Powerclaw contacts offer the same high current capacity as our original Powerclaws while providing the design engineer more options when board real estate is at a minimum.

* Contact factory for ratings

FEATURES

- **Quick disconnect**
Avoids the need for unfastening ring type terminals
- **Snap-On interface**
Ensures foolproof assembly and proper connection
- **Vertical mini-powerclaw UL rated**
For current interruption (hot-plug) so that equipment can be hot swapped
- **Anti-static packaging**
Meets electronics industry PCB requirements
- **Vacuum packaging**
Prevents tarnishing of contacts during shelf life

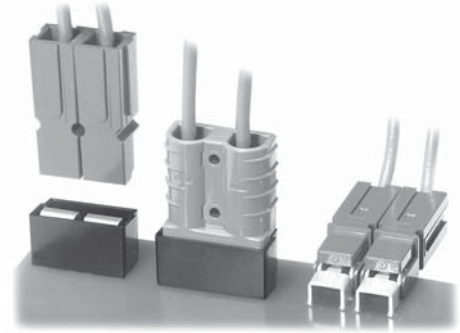

PRODUCT SPECIFICATIONS

| Product Information | PP Powerclaw | SB® Powerclaw Powerclaw | Locking Mini-Powerclaw | Vertical & Horizontal |
|------------------------------------|---|---|---|---|
| Maximum Current* (per Tin Contact) | 55 amps | 50 amps | 55 amps | 55 amps |
| Maximum Voltage (AC or DC) | 600 volts | 600 volts | 600 volts | 600 volts |
| Housing Material | Polycarbonate | Polycarbonate | Polycarbonate | Polycarbonate for vertical guide housings |
| Contact Material | Copper Alloy | Copper Alloy | Copper Alloy | Copper Alloy |
| Contact Plating: Tin | 100 microinches Sn over 50 microinches Ni | 100 microinches Sn over 50 microinches Ni | 100 microinches Sn over 50 microinches Ni | 100 microinches Sn over 50 microinches Ni |
| Contact Plating: Silver | 100 microinches Ag over 50 microinches Ni | 100 microinches Ag over 50 microinches Ni | 100 microinches Ag over 50 microinches Ni | 100 microinches Ag over 50 microinches Ni |
| Mating/Unmating Forces | 7 lbf. Average (31 Newtons) | 15 lbf. Average (66 Newtons) | 7 lbf. Average (31 Newtons) | 4 lbf. per contact (17 Newtons) |
| Suggested Board Thickness | .150" max. | .150" max. | .150" max. | .250" max. |

* See Temperature Rise Chart

| High Power PCB Contacts | | High Power PCB Contacts | |
|-----------------------------------|---|-------------------------|--|
| Test Condition | Specification Tested to and Met: | Test Condition | Specification Tested to and Met: |
| Mechanical | | Environmental | |
| Sine Vibration | MIL-STD-1344, Method 2005, Test Condition I. | Temperature Cycling | MIL-STD-1344, Method 1003, Test Condition A. |
| Mechanical Shock | MIL-STD-1344, Method 2004, Test Condition I. | Humidity | MIL-STD-1344, Method 3001, Type 1. |
| Mating Force | APP Specification, 7 lbf. average mating force. | Flammability | |
| Durability | 10,000 cycles, APP Specification | PP-, LP-, SB-series | UL94 V-0 |
| Electrical | | | |
| Temperature Rise at rated current | UL1977 | | |
| Dielectric Voltage | MIL-STD-1344, Method 3001, | | |
| Withstand | Type 1. | | |
| Contact Resistance | MIL-STD-1344, Method 3004, Type 1 | | |



HEADQUARTERS: 13 Pratts Junction Road, P.O. Box 579, Sterling, MA 01564 T:978-422-3600 F:978-422-3700

EUROPE: Rathealy Road, Fermoy Co. Cork, Ireland T:353-(0)25-32277 F:353-(0)25-32296

ASIA/PACIFIC: IDEAL Anderson Asia Pacific Ltd., Unit 922-928 Topsail Plaza, 11 On Sum Street, Shatin N.T., Hong Kong T:852-2636-0836 F:852-2635-9036

CHINA: IDEAL Anderson Technologies (Shenzhen) Ltd., Block A8 Tantou W. Ind. Par, Songgang Baoan District, Shenzhen, P.R. China 51810 T: 86-755-2768-2118 F: 86-755-2768-2218

TAIWAN: IDEAL Anderson Asia Pacific Ltd., Taiwan Branch, 4F.-2, No.116, Dadun 20th St., Situn District, Taichung City 407, Taiwan (R.O.C.) T: 886-4-2310-6451 F:886-4-2310-6460

www.andersonpower.com

ORDERING INFORMATION

Standard Powerclaw

| Position Definition | PC | XXX | X | XX |
|---------------------|-------------|-----------|-----------|-------------------------|
| | (Powerclaw) | (Color) | (Plating) | (Housing) |
| | | BLK-Black | T-Tin | PP-Powerpole 75 |
| | | RED-Red | S-Silver | LP-Locking Powerpole 75 |
| | | BLU-Blue | | SB-SB50 |
| | | WHT-White | | |
| | | GRA-Gray | | |
| | | GRN-Green | | |

Example: Blue 75 locking Powerclaw with tin plating (PC-BLU-T-LP)

Note: For additional colors please contact customer service

Individual Contacts and Guide Housings*

| Part No. | Description |
|-----------|---|
| PC5930S | Std PC horizontal mount contact – Silver (Ag) |
| PC5930T | Std PC horizontal mount contact – Tin (Sn) |
| PC5933T | Mini-PC vertical contact – Tin (Sn) |
| PC5933S | Mini-PC vertical contact – Silver (Ag) |
| PC5934T | Mini-PC horizontal contact – Tin (Sn) |
| PC5934S | Mini-PC horizontal contact – Silver (Ag) |
| PC-HSG-SB | Guide housing for SB50 (Black) |
| PC-HSG-PP | Guide housing for PP75 (Black) |

* For non-ESD bulk packaged product, add -BK to part number when ordering.

Packaging Quantity

APP's Powerclaw® contacts and connectors are packaged in ESD plastic and foam. This prevents our contacts and connectors from carrying any electrostatic charge that could damage ICs and other sensitive components on a PC board during assembly. The vacuum-sealed package also prevents tarnishing or adverse environmental reactions to occur on the contact. Contacts and housings are also available in bulk quantities, packaged in non-ESD cartons.

| Packaging | Quantity |
|-------------------------|--------------------|
| PP Powerclaw | 20 per bag |
| Locking PP Powerclaw | 20 per bag |
| SB Powerclaw | 10 per bag |
| Mini-Powerclaw contacts | 20 per bag |
| Guide Housings | 10 per bag or bulk |

TEMPERATURE RISE CHART

Temperature Rise at Constant Currents

Powerclaw® Tested in Accordance with EIA 364-70, No enclosure, 25+/-5 deg. C. ambient (#8 AWG Foil on Board Side, #6 AWG conductor on wire side, Contact Cat. No. 5900).
Temperature Rise of Contact at exit from Housing Interface (No Air Flow over Test Loop).

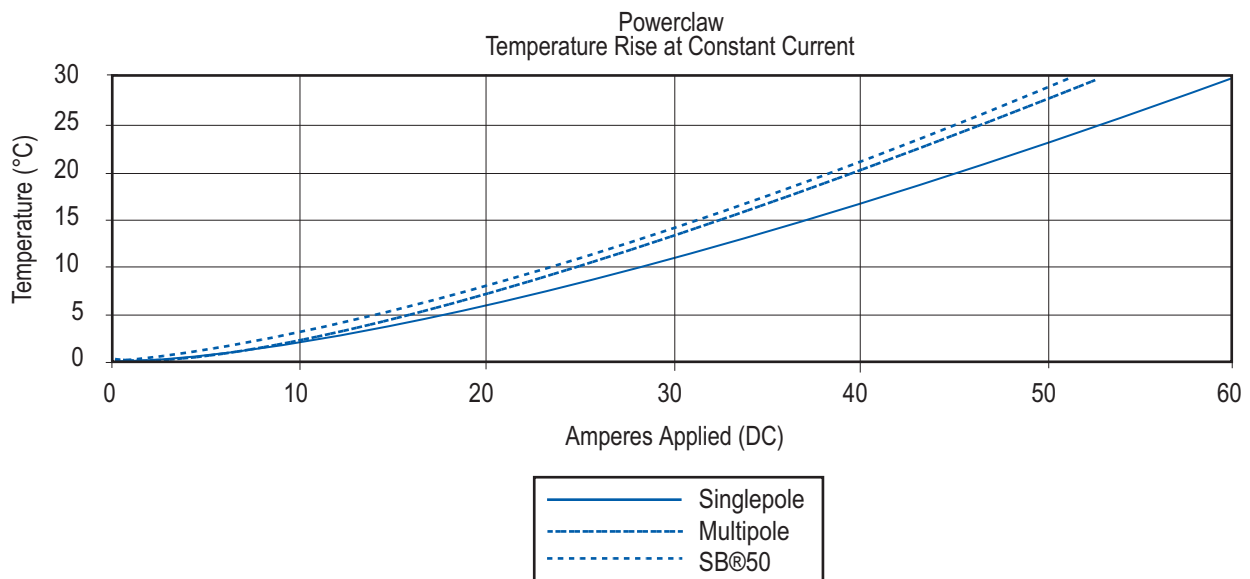

HEADQUARTERS: 13 Pratts Junction Road, P.O. Box 579, Sterling, MA 01564 T:978-422-3600 F:978-422-3700

EUROPE: Rathealy Road, Fermoy Co. Cork, Ireland T:353-(0)25-32277 F:353-(0)25-32296

ASIA/PACIFIC: IDEAL Anderson Asia Pacific Ltd., Unit 922-928 Topsail Plaza, 11 On Sum Street, Shatin N.T., Hong Kong T:852-2636-0836 F:852-2635-9036

CHINA: IDEAL Anderson Technologies (Shenzhen) Ltd., Block A8 Tantou W. Ind. Par, Songgang Baoan District, Shenzhen, P.R. China 51810 T: 86-755-2768-2118 F: 86-755-2768-2218

TAIWAN: IDEAL Anderson Asia Pacific Ltd., Taiwan Branch, 4F.-2, No.116, Dadun 20th St., Situn District, Taichung City 407, Taiwan (R.O.C.) T: 886-4-2310-6451 F:886-4-2310-6460

www.andersonpower.com

STANDARD POWERCLAW DIMENSIONS

Standard Powerclaw with locking PP75

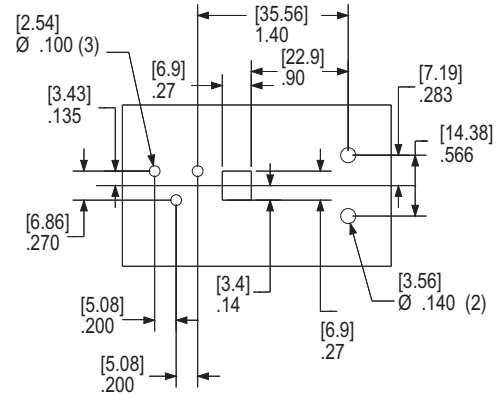
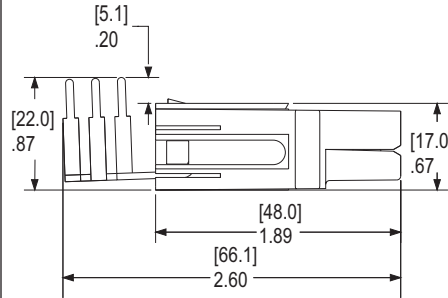
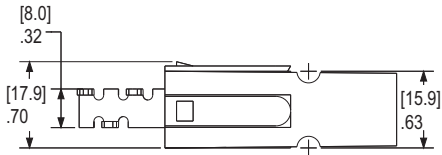

Standard Powerclaw with PP75

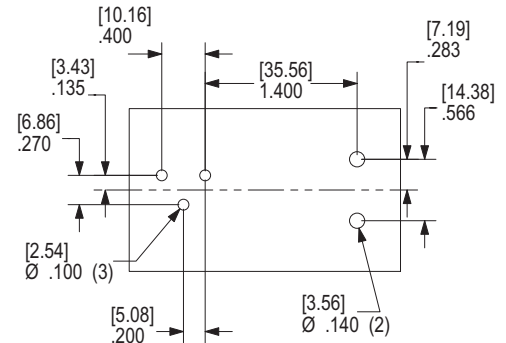
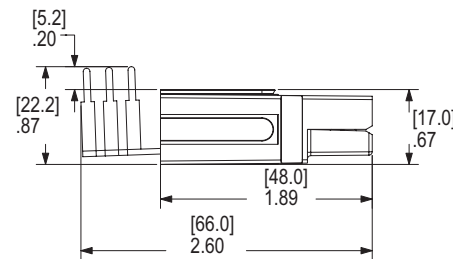
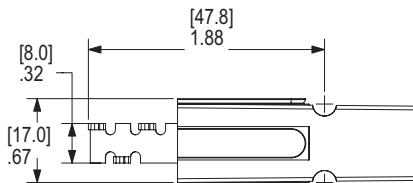

Standard Powerclaw with SB®50

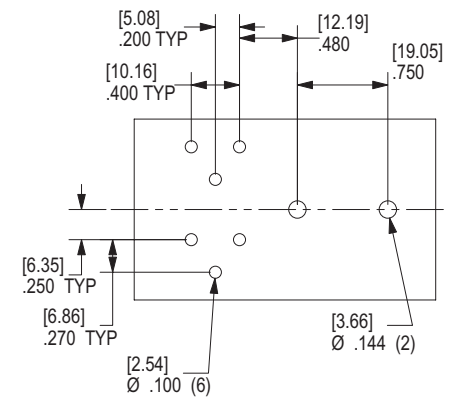
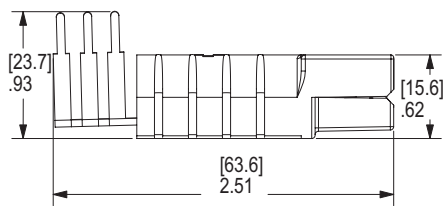
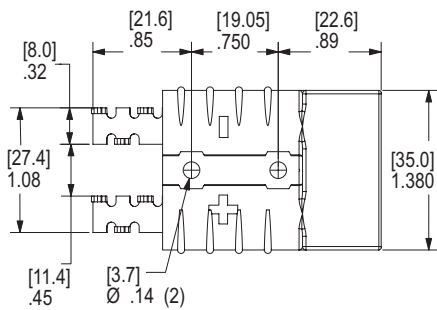

Staple for single powerpole

Part Number: PCSTAPLE-1

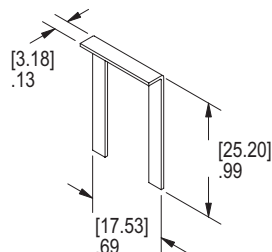

Staple for double powerpole

Part Number: PCSTAPLE-2

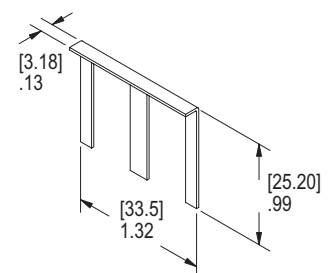

HEADQUARTERS: 13 Pratts Junction Road, P.O. Box 579, Sterling, MA 01564 T:978-422-3600 F:978-422-3700

EUROPE: Rathealy Road, Fermoy Co. Cork, Ireland T:353-(0)25-32277 F:353-(0)25-32296

ASIA/PACIFIC: IDEAL Anderson Asia Pacific Ltd., Unit 922-928 Topsail Plaza, 11 On Sum Street, Shatin N.T., Hong Kong T:852-2636-0836 F:852-2635-9036

CHINA: IDEAL Anderson Technologies (Shenzhen) Ltd., Block A8 Tantou W. Ind. Par. Songgang Baoan District, Shenzhen, P.R. China 51810 T: 86-755-2768-2118 F: 86-755-2768-2218

TAIWAN: IDEAL Anderson Asia Pacific Ltd., Taiwan Branch, 4F-2, No.116, Dadun 20th St., Situn District, Taichung City 407, Taiwan (R.O.C.) T: 886-4-2310-6451 F:886-4-2310-6460

www.andersonpower.com

MINI-POWERCLAW DIMENSIONS

Vertical Powerclaw

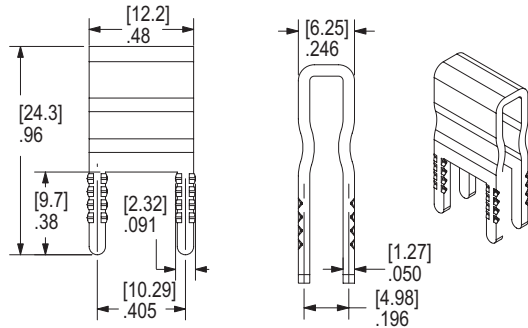

Horizontal Powerclaw

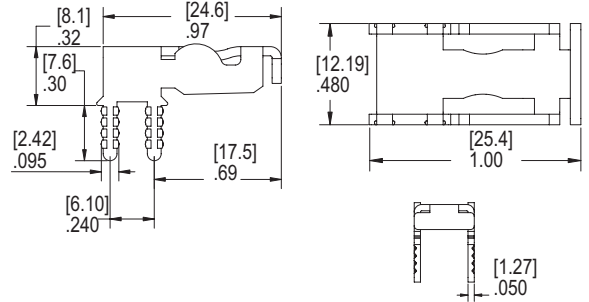

Vertical PCB Placement - Hole Configuration (with or without housing)

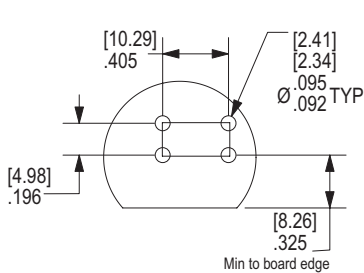

Vertical Contact With Single PP75
Guide Housing NOT Required

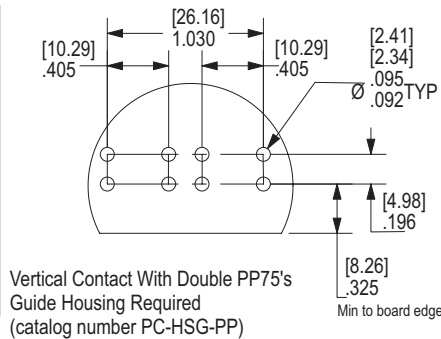

Vertical Contact With Double PP75's
Guide Housing Required
(catalog number PC-HSG-PP)

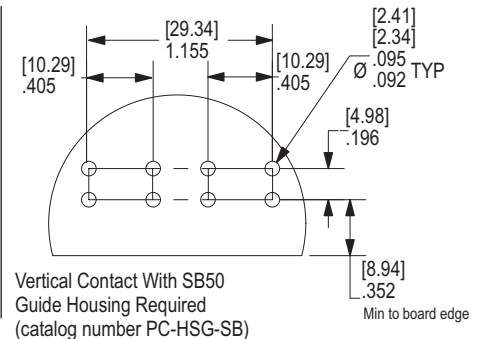

Vertical Contact With SB50
Guide Housing Required
(catalog number PC-HSG-SB)

Horizontal PCB Placement - Hole Configuration

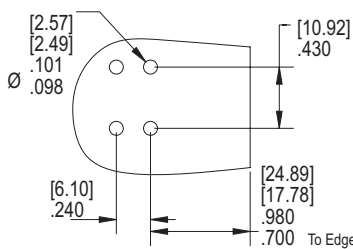

PCB Hole Layout
for Singlepole Powerpole

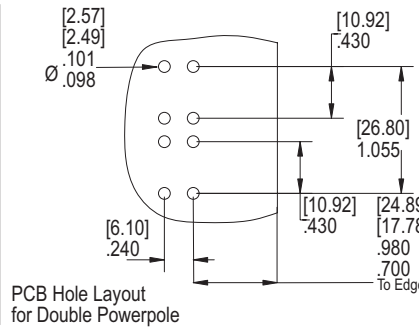

PCB Hole Layout
for Double Powerpole

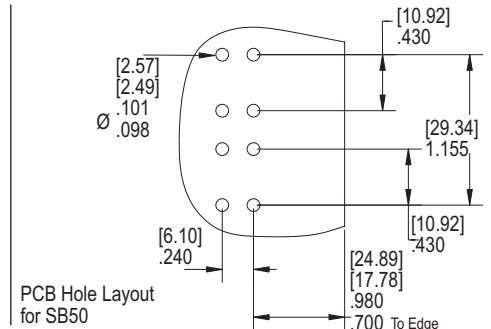

PCB Hole Layout
for SB50

Mated Horizontal Contacts (board attachment)

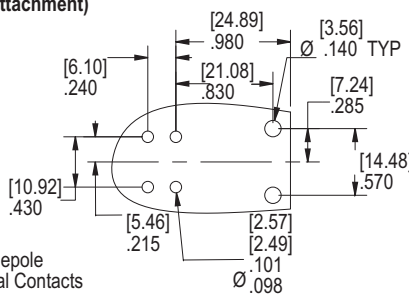

For Singlepole
Horizontal Contacts

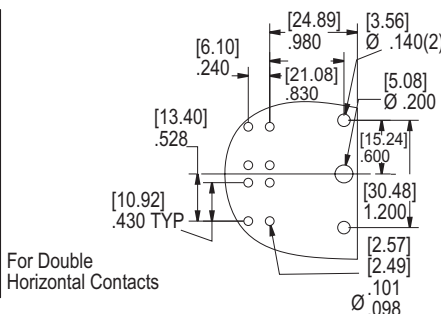

For Double
Horizontal Contacts

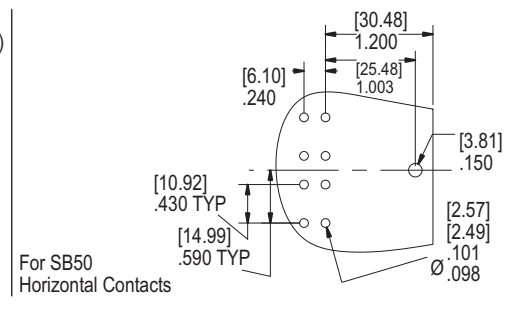

For SB50
Horizontal Contacts



All Data Subject To Change Without Notice

HEADQUARTERS: 13 Pratts Junction Road, P.O. Box 579, Sterling, MA 01564 T:978-422-3600 F:978-422-3700

EUROPE: Rathealy Road, Fermoy Co. Cork, Ireland T:353-(0)25-32277 F:353-(0)25-32296

ASIA/PACIFIC: IDEAL Anderson Asia Pacific Ltd., Unit 922-928 Topsail Plaza, 11 On Sum Street, Shatin N.T., Hong Kong T:852-2636-0836 F:852-2635-9036

CHINA: IDEAL Anderson Technologies (Shenzhen) Ltd., Block A8 Tantou W. Ind. Par, Songgang Baoan District, Shenzhen, P.R. China 51810 T: 86-755-2768-2118 F: 86-755-2768-2218

TAIWAN: IDEAL Anderson Asia Pacific Ltd., Taiwan Branch, 4F.-2, No.116, Dadun 20th St., Situn District, Taichung City 407, Taiwan (R.O.C.) T: 886-4-2310-6451 F:886-4-2310-6460

www.andersonpower.com



Connector Notes

For customer drawings, assembly instructions and individual data sheets, please visit www.andersonpower.com.

HEADQUARTERS: 13 Pratts Junction Road, P.O. Box 579, Sterling, MA 01564 T:978-422-3600 F:978-422-3700

EUROPE: Rathealy Road, Fermoy Co. Cork, Ireland T:353-(0)25-32277 F:353-(0)25-32296

ASIA/PACIFIC: IDEAL Anderson Asia Pacific Ltd., Unit 922-928 Topsail Plaza, 11 On Sum Street, Shatin N.T., Hong Kong T:852-2636-0836 F:852-2635-9036

AL Anderson Technologies (Shenzhen) Ltd., Block A8 Tantou W. Ind. Par, Songgang Baoan District, Shenzhen, P.R. China 51810 T: 86-755-2768-2118 F: 86-755-2768-2218

AL Anderson Asia Pacific Ltd., Taiwan Branch, 4F.-2, No.116, Dadun 20th St., Situn District, Taichung City 407, Taiwan (R.O.C.) T: 886-4-2310-6451 F:886-4-2310-6460

www.andersonpower.com

FEATURES

- Secondary latching - variety of sizes**
Provides security in applications where shock and/or vibration may be severe
- Variety of contacts**
Enables flexibility in wiring sizes Allows customization
- Order as individual components**
Allows custom configurations
- Order blindmate power pak preassembled**
Streamline manufacturing process
- Chamfered housing**
Allows units to self-align during Blindmate (Rack & Panel applications)
- Flat wiping contact system**
Allows for minimal contact resistance at high current, wiping action cleans contact surface during connection/disconnection
- Optional silver plated contacts**
Offers greatest longevity when using high power, elevated temperature applications
- Optional 10 or 30 amp ground contacts**
First mate/last break ground terminals help provide system safety
- UL94 V-0 housing material**
Provides security in knowledge that the connector chosen meets strict UL flammability ratings



PRODUCT RANGE

| | |
|---|----------------|
| UL Current Rating (Amperes)* | 10* to 45* |
| UL Voltage Ratings (Volts)** | 600* |
| Contact Barrel Wire Size (AWG) | #10 to #20 |
| (mm ²) | 4.0 to 0.5 |
| Maximum Wire Insulation Diameter (inches) | 0.137 to 0.175 |
| (mm) | 3.48 to 4.45 |
| AVG Contact Resistance* (micro-ohms) | 2200 to 525 |
| Insulation Withstanding | 2200 |
| Test Voltage (Volts AC/DC) | |
| Contact Retention Force (lbf) | 25 to 35 |
| Avg. Connection/Disconnect (lbf) | 5 to 3 |
| Operating Temperature Range °C*** | -20° to 105° |
| °F | -4° to 221° |
| Flammability Rating of Housing Material | UL94 V-0 |



* UL Rated for 65°C largest wire or cable size

** Both AC & DC Voltage

*** Contact factory for higher temperature rated connectors

PRODUCT INFORMATION

Invented by Anderson Power Products®, the innovative Power Pak connectors provide cost-effective reliability, design flexibility and safety for your products' manufacture, installation and maintenance.

The Powerpole® Paks series provide a high impact and corrosion-resistant black thermoplastic outer shells that contain our dovetail 10, 15, 30 and 45 amp Powerpole® connectors. They allow easy connection and disconnection of electrical equipment in commercial and industrial applications. Cable clamps provide strain relief and integral latches prevent accidental disconnection of your equipment. The three housings – Plug With Latch, Plug Without Latch, and Snap-In Receptacle – accommodate 2, 3, 4, 6, 8 and 10 circuits for orderly cable management systems and “clean looking” appearances.

The Blindmate Power Pak series, which has been developed in response to the unique power requirements in the Communications and Uninterruptible Power Supply (UPS) markets. This series offers a high impact and corrosion-resistant black thermoplastic outer shells, that houses our dovetail 10, 15, 25 amp (PCB contacts), 30 and 45 amp Powerpole® connectors.



Powerpole® 1327,
1345 and 1330 series



File No. LR25154 File No. E26226 All Data Subject To Change Without Notice

HEADQUARTERS: 13 Pratts Junction Road, P.O. Box 579, Sterling, MA 01564 T:978-422-3600 F:978-422-3700

EUROPE: Rathealy Road, Fermoy Co. Cork, Ireland T:353-(0)25-32277 F:353-(0)25-32296

ASIA/PACIFIC: IDEAL Anderson Asia Pacific Ltd., Unit 922-928 Topsail Plaza, 11 On Sum Street, Shatin N.T., Hong Kong T:852-2636-0836 F:852-2635-9036

CHINA: IDEAL Anderson Technologies (Shenzhen) Ltd., Block A8 Tantou W. Ind. Par, Songgang Baoan District, Shenzhen, PR. China 51810 T: 86-755-2768-2118 F: 86-755-2768-2218

TAIWAN: IDEAL Anderson Asia Pacific Ltd., Taiwan Branch, 4F.-2, No.116, Dadun 20th St., Situn District, Taichung City 407, Taiwan (R.O.C.) T: 886-4-2310-6451 F:886-4-2310-6460

www.andersonpower.com

Powerpole® Paks are high impact and corrosion-resistant black thermoplastic outer shells for containing our 10 to 45 amp Powerpole® connectors. They allow easy connection and disconnection of electrical equipment in commercial and industrial applications. Cable clamps provide strain relief and integral latches prevent accidental disconnection of your equipment. The three housings – Plug With Latch, Plug Without Latch, and Snap-In Receptacle – accommodate 2 to 10 circuits for orderly cable management and “clean looking” connectors.

FEATURES

- **Positive latching**
Provides security in applications where shock and/or vibration may be severe
- **Variety of contact sizes**
Enables flexibility in wiring sizes and allows customization
- **Integral strain relief**
Organizes individual wires and reduces risk of wire breakage



PRODUCT SPECIFICATIONS

| Connector Model | PP10P&S | PP15 | PP30 | PP30P&S | PP45 | Material Properties |
|--|-----------------------------|------------------------|-------------------------|------------------|-------------------------|---|
| UL Current Rating (Amperes)* | 10 | 15 | 30 | 30**** | 45 | Powerpole Pak Housing Polycarbonate, UL94 V-0 |
| UL Voltage Ratings (Volts)** | 600* | | | | | Powerpole Housing Polycarbonate, UL94 V-0 |
| Contact Barrel Wire Size (AWG) (mm ²) | #14 / #16 2 to 1.3 | #16 / #20 1.3 to .5 | #12 / #16 3.3 to 1.3 | #10 5.3 | #10 / #14 5.3 to 2.1 | Powerpole Contacts Base metal copper |
| Maximum Wire Insulation Diameter (inches) (mm) | 0.137 3.48 | 0.175 4.45 | 0.175 4.45 | 0.175 4.45 | 0.175 4.45 | Plating Wire contacts - tin or silver |
| AVG Contact Resistance* (micro-ohms) | 2200 | 875 | 600 | 600 | 525 | Powerpole Springs Stainless steel |
| Insulation Withstanding Test Voltage (Volts AC/DC) | 2200 | | | | | |
| Contact Retention Force (lbf) | 25 | 25 | 25 | 25 | 35 | |
| Avg. Connection/Disconnect (lbf) | 5 - LD N/A | 3 - LD 5 - HD | 3 - LD 5 - HD | 3 - LD 5 - HD | 3 - LD 5 - HD | |
| Operating Temperature Range °C*** °F | -20° to 105° -4° to 221° | | | | | |
| Flammability Rating of Housing Material | UL94 V-0 | | | | | |



* UL Rated for 65°C largest wire or cable size
 ** Both AC & DC Voltage
 *** Contact factory for higher temperature rated connectors
 **** Based on 10 AWG

ORDERING INFORMATION

Plug Without Latch

Includes Plug Housing, 30 amp black Powerpole® connectors and Cable Clamp Hardware Pak.

| Part Number | Number of Poles |
|-----------------|-----------------|
| 1450G2 | 2 |
| 1451G2 (female) | 3 |
| 1451G6 (male) | 3 |
| 1452G2 | 4 |
| 1453G2 | 6 |
| 1454G2 | 8 |

Note: The recommended tightening torque for conduit/cable clamp screws is 5in.lb max. – over-tightening may cause stripping to occur.

Shell Housing Only, Plug Without Latch

| Part Number | Number of Poles |
|-------------|-----------------|
| 1461G1 | 2, 3, 4 |
| 1461G2 | 5, 6 |
| 1461G3 | 7, 8 |

Plug With Latch

Includes Plug Housing, 30 amp black Powerpole® connectors and Cable Clamp Hardware Pak.

| Part Number | Number of Poles |
|---------------|-----------------|
| 1450G3 | 2 |
| 1451G3 (male) | 3 |
| 1452G3 | 4 |
| 1453G3 | 6 |
| 1454G3 | 8 |

Note: The recommended tightening torque for conduit/cable clamp screws is 5in.lb max. – over-tightening may cause stripping to occur.

Shell Housing Only, Plug With Latch

| Part Number | Number of Poles |
|-------------|-----------------|
| 1460G1 | 2, 3, 4 |
| 1460G2 | 5, 6 |
| 1460G3 | 7, 8 |
| 1460G4 | 9, 10 |

Snap-in Receptacle

Includes Snap-in Housing, 30 amp black Powerpole® connectors and Retaining Pin(s).

| Part Number | Number of Poles |
|-----------------|-----------------|
| 1450G1 | 2 |
| 1451G1 (female) | 3 |
| 1452G1 | 4 |
| 1453G1 | 6 |
| 1454G1 | 8 |

Shell Housing Only, Snap-in Receptacle

| Part Number | Number of Poles |
|-------------|-----------------|
| 1470G1 | 2, 3, 4 |
| 1470G2 | 5, 6 |
| 1470G3 | 7, 8 |
| 1470G4 | 9, 10 |

Note: For additional colors please contact customer service

HEADQUARTERS: 13 Pratts Junction Road, P.O. Box 579, Sterling, MA 01564 T:978-422-3600 F:978-422-3700

EUROPE: Rathealy Road, Fermoy Co. Cork, Ireland T:353-(0)25-32277 F:353-(0)25-32296

ASIA/PACIFIC: IDEAL Anderson Asia Pacific Ltd., Unit 922-928 Topsail Plaza, 11 On Sum Street, Shatin N.T., Hong Kong T:852-2636-0836 F:852-2635-9036

CHINA: IDEAL Anderson Technologies (Shenzhen) Ltd., Block A8 Tantou W. Ind. Par, Songgang Baoan District, Shenzhen, PR. China 51810 T: 86-755-2768-2118 F: 86-755-2768-2218

TAIWAN: IDEAL Anderson Asia Pacific Ltd., Taiwan Branch, 4F.-2, No.116, Dadun 20th St., Situn District, Taichung City 407, Taiwan (R.O.C.) T: 886-4-2310-6451 F:886-4-2310-6460

www.andersonpower.com

ORDERING INFORMATION

Accessories

Cable Clamp Hardware Pak

| Part Number | Maximum Number of Poles |
|-------------|-------------------------|
| 115G1 | 4 |
| 115G2 | 6 |
| 115G3 | 8 |
| 115G4 | 10 |

Cable Clamp Hardware Pak for Plug With Latch or Plug Without Latch – includes cable clamp, 2 screws & retaining pin(s) for strain relief.

Retaining Pins for Snap-in Receptacle

| Part Number | Number of Pins Required |
|-------------|--------------------------|
| 110G9 | 1 Required for a 4 Pole |
| 110G9 | 2 Required for a 6 Pole |
| 110G9 | 3 Required for a 8 pole |
| 110G9 | 4 Required for a 10 pole |

Flexible Conduit Hardware Pak

| Part Number | Maximum Number of Poles |
|-------------|-------------------------|
| 110G10 | 4 |
| 110G11 | 6 |
| 110G15 | 8 |

Flexible Conduit Hardware Pak for Plug With Latch and Plug without Latch – includes conduit clamp, 2 screws & retaining pin(s) for capturing flexible conduit at back end of plug.

Tooling

| Part Number | Description |
|-------------|-----------------------------------|
| 111038G2 | Contact insertion/extraction tool |
| 1309G1 | Hand tool - #14 to #16 |
| 1309G2 | Hand tool #12 to #20 |
| 1309G3 | Hand tool for p/n 261G2-LPBK |
| 1309G5 | Hand tool for p/n 200G2L & 201G2H |

tooling continued

| Part Number | Description |
|-------------|-----------------------------------|
| 1396G1 | Hand Tool |
| 1387G1 | Pneumatic Tool |
| 1388G8 | - Die #10 |
| 1389G8 | - Locator #10 |
| 260G1 | Applicator only (110V & 220V) |
| 260G3 | Applicator only (110V & 220V) |
| 260G14* | Applicator only (110V & 220V) |
| 260G15* | Applicator only (110V & 220V) |
| 260G18** | Applicator only (110V & 220V) |
| 280G1 | Applicator and press (110V, 60Hz) |
| 280G2 | Applicator and press (110V, 60Hz) |
| 250G1 | Press only (110V, 60Hz) |
| 280G4 | Applicator and press (220V, 50Hz) |
| 250G2 | Press only (220V, 50Hz) |

* Denotes mini-style applicator for use with existing "K" or "T" press
 ** Denotes mini-style applicator for use with existing "K" or "T" and "G" press

DIMENSIONS

Plug with Latch

| Pole | -A- | | -B- | | -C- | | -D- | |
|---------|-------|------|-------|------|-------|-----|-------|------|
| | mm | in. | mm | in. | mm | in. | mm | in. |
| 2, 3, 4 | 57.15 | 2.25 | 31.50 | 1.24 | 21.59 | .85 | 49.28 | 1.94 |
| 5, 6 | 57.15 | 2.25 | 39.62 | 1.56 | 21.59 | .85 | 49.28 | 1.94 |
| 7, 8 | 57.15 | 2.25 | 47.50 | 1.87 | 21.59 | .85 | 49.28 | 1.94 |
| 9, 10 | 71.63 | 2.82 | 46.74 | 1.84 | 21.59 | .85 | 63.75 | 2.51 |

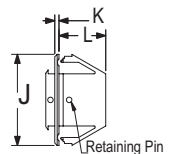
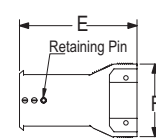
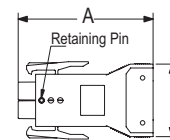

Plug without Latch

| Pole | -E- | | -F- | | -G- | | -H- | |
|---------|-------|------|-------|------|-------|-----|-------|------|
| | mm | in. | mm | in. | mm | in. | mm | in. |
| 2, 3, 4 | 53.09 | 2.09 | 31.50 | 1.24 | 21.59 | .85 | 49.28 | 1.94 |
| 5, 6 | 53.09 | 2.09 | 39.62 | 1.56 | 21.59 | .85 | 49.28 | 1.94 |
| 7, 8 | 53.09 | 2.09 | 47.50 | 1.87 | 21.59 | .85 | 49.28 | 1.94 |

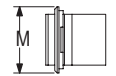
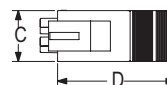

Plug With Latch

Plug Without Latch

Snap-in Receptacle

Snap-in Receptacle

| Pole | -J- | | -K- | | -L- | | -M- | | Knock-out Size | |
|---------|-------|------|------|-----|-------|-----|-------|------|----------------|-------------|
| | mm | in. | mm | in. | mm | in. | mm | in. | mm | in. |
| 2, 3, 4 | 38.10 | 1.50 | 1.78 | .07 | 19.56 | .77 | 27.94 | 1.10 | 25.40 x 31.75 | 1.00 x 1.25 |
| 5, 6 | 47.75 | 1.88 | 1.78 | .07 | 19.56 | .77 | 27.94 | 1.10 | 25.40 x 41.15 | 1.00 x 1.62 |
| 7, 8 | 54.10 | 2.13 | 1.78 | .07 | 19.56 | .77 | 27.94 | 1.10 | 25.40 x 47.75 | 1.00 x 1.88 |
| 9, 10 | 61.98 | 2.44 | 1.78 | .07 | 19.56 | .77 | 27.94 | 1.10 | 25.40 x 55.58 | 1.00 x 2.19 |

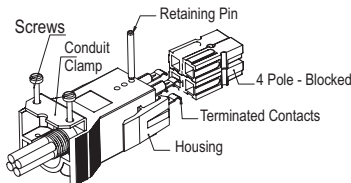

Powerpole® Pak With Latch

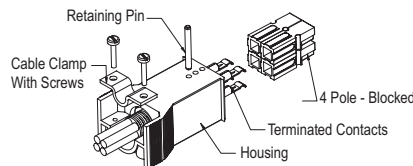

Powerpole® Pak Without Latch

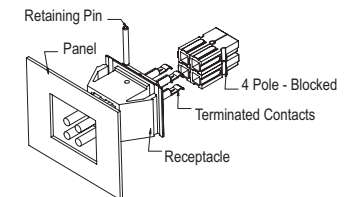

Powerpole® Pak Snap-in Receptacle

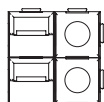

2 Pole Male & Female

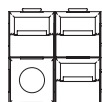

3 Pole Male

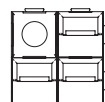

3 Pole Female

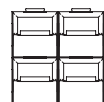

4 Pole Male & Female

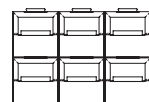

6 Pole Male & Female

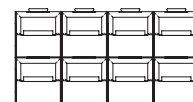

8 Pole Male & Female

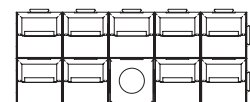

9 Pole Male (above)
9 Pole Female (below)

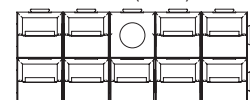

Powerpole® 1327, 1345 and 1330 series



File No. E26226 All Data Subject To Change Without Notice

HEADQUARTERS: 13 Pratts Junction Road, P.O. Box 579, Sterling, MA 01564 T:978-422-3600 F:978-422-3700

EUROPE: Rathealy Road, Fermoy Co. Cork, Ireland T:353-(0)25-32277 F:353-(0)25-32296

ASIA/PACIFIC: IDEAL Anderson Asia Pacific Ltd., Unit 922-928 Topsail Plaza, 11 On Sum Street, Shatin N.T., Hong Kong T:852-2636-0836 F:852-2635-9036

CHINA: IDEAL Anderson Technologies (Shenzhen) Ltd., Block A8 Tantou W. Ind. Par, Songgang Baoan District, Shenzhen, PR. China 51810 T: 86-755-2768-2218 F: 86-755-2768-2218

TAIWAN: IDEAL Anderson Asia Pacific Ltd., Taiwan Branch, 4F-2, No.116, Dadun 20th St., Situn District, Taichung City 407, Taiwan (R.O.C.) T: 886-4-2310-6451 F:886-4-2310-6460

www.andersonpower.com

Anderson Power Products® (APP) now offers the Blindmate Powerpole® Pak for wire to printed circuit board applications. The Blindmate Powerpole® Pak corrects for up to .45" of misalignment.

The Blindmate Powerpole® Pak, was a custom assembly for unique power requirements in the Communications and Uninterruptible Power Supply (UPS) markets. It can now be ordered as individual components enabling customers to customize the Blindmate Powerpole® Pak for unique applications.

FEATURES

- **Corrects for .45" misalignment**

Allows units to self-align during Blindmate (Rack & Panel applications)

- **Dovetail contact housings**

Can be configured in almost any combination to provide signal power and make first / break last circuits as well as unique keying

- **Wide range of contact sizes**

Provides engineers flexibility during system design

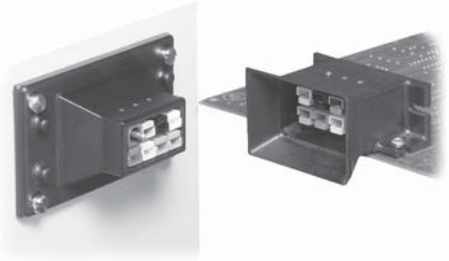

PRODUCT SPECIFICATIONS

| Connector Model | PP10 | PP15 | PCB25 | PP30 | PP45 | Material Properties | |
|---|-------------------------|------------------------|------------|-------------------------|-------------------------|------------------------------|--|
| UL Current Rating (Amperes)* | 10 | 15 | 25 | 30 | 45 | Blindmate Housing | Polycarbonate, UL94 V-0 |
| UL Voltage Ratings (Volts)** | 600* | | | | | Powerpole Housing | Polycarbonate, UL94 V-0 |
| Contact Barrel Wire Size (AWG) (mm ²) | #14 / #16 2.1 to 1.3 | #16 / #20 1.3 to .5 | N/A N/A | #12 / #16 3.3 to 1.3 | #10 / #14 5.3 to 2.1 | Powerpole Contacts | Base metal copper |
| Maximum Wire Insulation Diameter (inches) (mm) | 0.137 3.48 | 0.175 4.45 | N/A N/A | 0.175 4.45 | 0.175 4.45 | Plating | Wire contacts - tin or silver PCB contacts - tin |
| AVG Contact Resistance* (micro-ohms) | 2200 | 875 | 600 | 600 | 525 | Powerpole Springs | Stainless steel |
| Insulation Withstanding Test Voltage (Volts AC/DC) | 2200 | | | | | Mechanical Properties | |
| Contact Retention Force (lbf) | 25 | 25 | 25 | 25 | 35 | Mating Cycle | 500 min (loaded blindmate housing) |
| Avg. Connection/Disconnect (lbf) | 5 - LD | 3 - LD | 3 - LD | 3 - LD | 3 - LD | Mating Force | 25 lbs average (fully loaded housing) |
| Operating Temperature Range °C*** | -20° to 105° | | | | | Misalignment Allowance | Radial - .45 max inches (1.14mm) Vertical - .45 max inches (11.43mm) Horizontal - .47 max inches (11.93mm) |
| °F | -4° to 221° | | | | | Engagement Distance | .900 (±.010) inches 22.86 (±.25) mm |
| Flammability Rating of Housing Material | UL94 V-0 | | | | | | |

* UL Rated for 65°C largest wire or cable size ** Both AC & DC Voltage *** Contact factory for higher temperature rated connectors

ORDERING INFORMATION

Housings Only

| Part Number | Description |
|-------------|--|
| BMPP10-45P | 2 x 4 Blindmate plug , hardware & pin |
| BMPP10-45R | 2 x 4 Blindmate receptacle, hardware & pin |
| BMHSG-P | 2 x 4 Plug housing only |
| BMHSG-R | 2 x 4 Receptacle housing only |
| 1327 | PP15/45 red housing |
| 1327G5 | PP15/45 green |
| 1327G6 | PP15/45 black |
| 1327G7 | PP15/45 white |
| 1327G8 | PP15/45 blue |
| 1327G16 | PP15/45 yellow |
| 1327G17 | PP15/45 orange |
| 1327G18 | PP15/45 gray |
| 1327G21 | PP15/45 brown |
| 1327G22 | PP15/45 pink |
| 1327G23 | PP15/45 purple |
| PP30GND-P | Powerpole pin, green |
| PP30GND-S | Powerpole socket, green |

* LD - low detent or HD - high detent
Note: For additional colors please contact customer service.
For finger proof housings see page 18.

Contacts Only*

| Part Number | Description | Wire AWG | sq. mm |
|-------------|----------------------------|----------|-----------|
| 1331 | PP30 amp, loose piece - LD | 12/16 | 3.31/1.31 |
| 1332 | PP15 amp, loose piece - LD | 16/20 | 1.31/.52 |
| 261G2-LPBK | PP45 amp, loose piece - LD | 10/14 | 5.26/2.08 |
| 1230G1 | PP30 amp pin | 10 | 5.26 |
| 1232G1 | PP30 amp socket | 10 | 5.26 |
| 261G1 | PP30 amp, reel - LD | 12/16 | 3.31/1.31 |
| 261G2 | PP45 amp, reel - LD | 10/14 | 5.26/2.08 |
| 262G1 | PP15 amp, reel - LD | 16/20 | 1.31/.52 |
| 1377G1 | Right Angle - LD | 0.70 | 17.8 |
| 1377G2 | Right Angle - LD | 0.40 | 10.2 |
| 1377G11 | Right Angle - LD | 0.70 | 17.8 |
| 1377G12 | Right Angle - LD | 0.40 | 10.2 |
| 1377G14 | Right Angle - LD | 0.18 | 4.6 |
| 1377G15 | Right Angle - LD | 1.02 | 25.9 |
| 1377G16 | Right Angle - LD | 0.72 | 18.3 |
| 1377G17 | Right Angle - LD | 0.88 | 22.4 |
| 1377G18 | Right Angle - LD | 0.58 | 14.7 |
| 1317G1 | Right Angle - HD | 0.70 | 17.8 |
| 1317G2 | Right Angle - HD | 0.40 | 10.2 |
| 1317G11 | Right Angle - HD | 0.70 | 17.8 |

contacts only continued

| Part Number | Description | Wire AWG | sq. mm |
|-------------|------------------------|----------|--------|
| 1317G12 | Right Angle - LD | 0.40 | 10.2 |
| 1317G14 | Right Angle - LD | 0.18 | 4.6 |
| 1317G15 | Right Angle - LD | 1.02 | 25.9 |
| 1317G16 | Right Angle - LD | 0.72 | 18.3 |
| 1317G17 | Right Angle - LD | 0.88 | 22.4 |
| 1317G18 | Right Angle - LD | 0.58 | 14.7 |
| 1377G3 | Straight Terminal - LD | 2.16 | 54.9 |
| 1377G4 | Straight Terminal - LD | 1.7 | 43.2 |
| 1377G13 | Straight Terminal - LD | 1.11 | 28.2 |
| 1317G3 | Straight Terminal - HD | 2.16 | 54.9 |
| 1317G4 | Straight Terminal - HD | 2.16 | 43.2 |
| 1317G13 | Straight Terminal - HD | 1.11 | 28.2 |

Hardware

| Part Number | Description |
|-------------|-------------------|
| 110G50 | Used with BMHSG-P |
| 110G51 | Used with BMHSG-R |

HEADQUARTERS: 13 Pratts Junction Road, P.O. Box 579, Sterling, MA 01564 T:978-422-3600 F:978-422-3700

EUROPE: Rathealy Road, Fermoy Co. Cork, Ireland T:353-(0)25-32277 F:353-(0)25-32296

ASIA/PACIFIC: IDEAL Anderson Asia Pacific Ltd., Unit 922-928 Topsail Plaza, 11 On Sum Street, Shatin N.T., Hong Kong T:852-2636-0836 F:852-2635-9036

CHINA: IDEAL Anderson Technologies (Shenzhen) Ltd., Block A8 Tantou W. Ind. Par, Songgang Baoan District, Shenzhen, PR. China 51810 T: 86-755-2768-2118 F: 86-755-2768-2218

TAIWAN: IDEAL Anderson Asia Pacific Ltd., Taiwan Branch, 4F-2, No.116, Dadun 20th St., Situn District, Taichung City 407, Taiwan (R.O.C.) T: 886-4-2310-6451 F:886-4-2310-6460

www.andersonpower.com

ORDERING INFORMATION

Tooling

| Part Number | Description |
|-------------|-----------------------------------|
| 1387G1 | Pneumatic Tool |
| 1388G8 | - Die #10 |
| 1389G8 | - Locator #10 |
| 260G1 | Applicator only (110V & 220V) |
| 260G14* | Applicator only (110V & 220V) |
| 260G15* | Applicator only (110V & 220V) |
| 260G18** | Applicator only (110V & 220V) |
| 280G1 | Applicator and press (110V, 60Hz) |
| 250G1 | Press only (110V, 60Hz) |
| 280G4 | Applicator and press (220V, 50Hz) |
| 250G2 | Press only (220V, 50Hz) |

* Denotes mini-style applicator for use with existing "K" or "T" press
 ** Denotes mini-style applicator for use with existing "K" or "T" and "G" press

Tooling

| Part Number | Description |
|-------------|-----------------------------------|
| 111038G2 | Contact insertion/extraction tool |
| 1309G3 | Hand tool for p/n 261G2-LPBK |
| 1309G2 | Hand tool #12 to #20 |
| 1309G5 | Hand tool for p/n 200G2L & 201G2H |
| 1396G1 | Hand Tool |

DIMENSIONS

Plug Outline

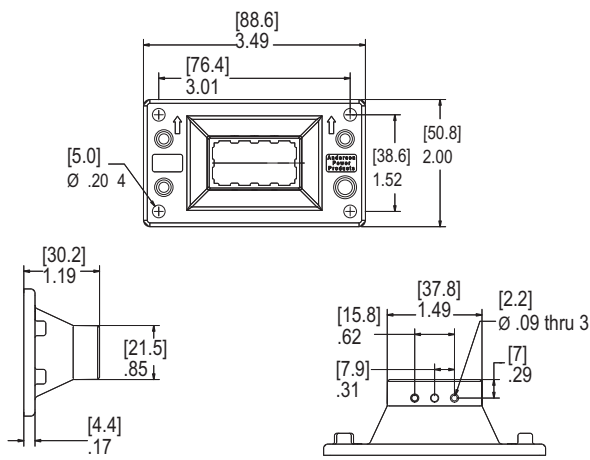

Receptacle Outline

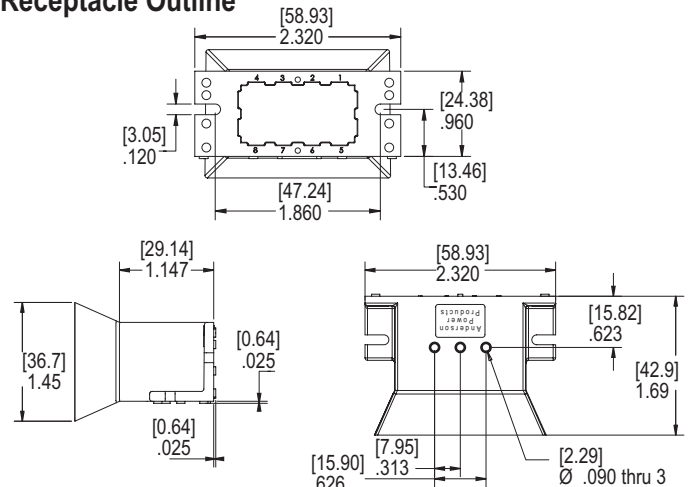

Plug Panel Cutout

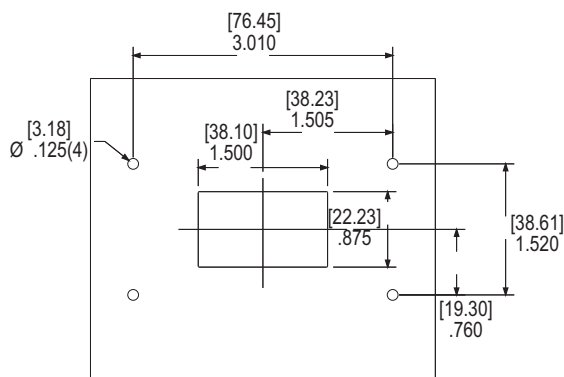

Receptacle PCB Layout

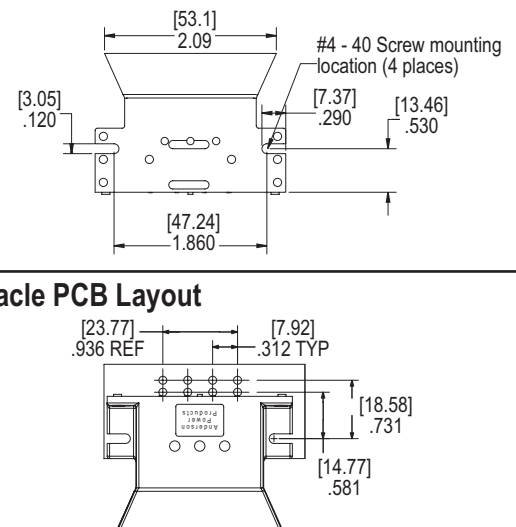

Powerpole® 1327,
1345 and 1330 series



File No. LR25154



File No. E26226

All Data Subject To Change Without Notice

HEADQUARTERS: 13 Pratts Junction Road, P.O. Box 579, Sterling, MA 01564 T:978-422-3600 F:978-422-3700

EUROPE: Rathely Road, Fermoy Co. Cork, Ireland T:353-(0)25-32277 F:353-(0)25-32296

ASIA/PACIFIC: IDEAL Anderson Asia Pacific Ltd., Unit 922-928 Topsail Plaza, 11 On Sum Street, Shatin N.T., Hong Kong T:852-2636-0836 F:852-2635-9036

CHINA: IDEAL Anderson Technologies (Shenzhen) Ltd., Block A8 Tantou W. Ind. Par, Songgang Baoan District, Shenzhen, P.R. China 51810 T: 86-755-2768-2218 F: 86-755-2768-2218

TAIWAN: IDEAL Anderson Asia Pacific Ltd., Taiwan Branch, 4F-2, No.116, Dadun 20th St., Situn District, Taichung City 407, Taiwan (R.O.C.) T: 886-4-2310-6451 F:886-4-2310-6460

www.andersonpower.com



Connector Notes

For customer drawings, assembly instructions and individual data sheets, please visit www.andersonpower.com.

HEADQUARTERS: 13 Pratts Junction Road, P.O. Box 579, Sterling, MA 01564 T:978-422-3600 F:978-422-3700

EUROPE: Rathealy Road, Fermoy Co. Cork, Ireland T:353-(0)25-32277 F:353-(0)25-32296

ASIA/PACIFIC: IDEAL Anderson Asia Pacific Ltd., Unit 922-928 Topsail Plaza, 11 On Sum Street, Shatin N.T., Hong Kong T:852-2636-0836 F:852-2635-9036

CHINA: IDEAL Anderson Technologies (Shenzhen) Ltd., Block A8 Tantou W. Ind. Par, Songgang Baoan District, Shenzhen, P.R. China 51810 T: 86-755-2768-2118 F: 86-755-2768-2218

TAIWAN: IDEAL Anderson Asia Pacific Ltd., Taiwan Branch, 4F.-2, No.116, Dadun 20th St., Situn District, Taichung City 407, Taiwan (R.O.C.) T: 886-4-2310-6451 F:886-4-2310-6460

www.andersonpower.com

FEATURES

- **Disconnect contacts**
Provide for modular assembly or simple field repair lowering manufacturing and maintenance costs
- **Hot swap ***
Allows for repair and maintenance of components without the need for powering down equipment
- **Solid copper contacts with silver plating**
Superior conductivity for lower heating

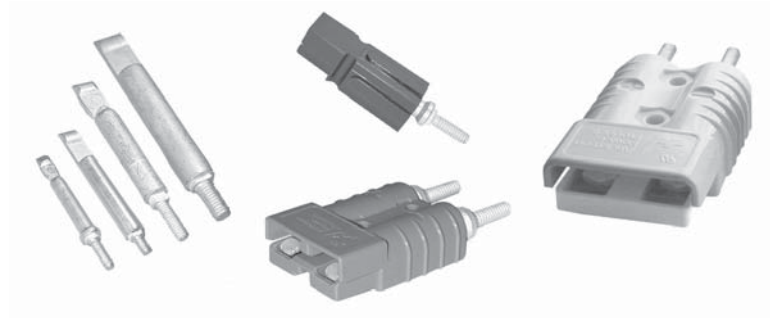

* Tested per UL1977 - overload and resistance to ARC - Based on singlepole

PRODUCT RANGE

| Contact Information | PP75 | PP180 | SB® 50 | SB®120 | SB®175 | SB®350 |
|---|---|-------------|-------------|--------------|-------------|---------------|
| Maximum Current (per contact) | 75 amps | 180 amps | 50 amps | 120 amps | 175 amps | 350 amps |
| Maximum Voltage (AC or DC) | 600 | | | | | |
| Contact Material | 99 % copper | | | | | |
| Plating | Silver | | | | | |
| Contact Resistance | <100 micro-ohms | | | | | |
| Mating Life-No Load (cycles) | 10,000 | | | | | |
| Mating Connector Information | | | | | | |
| Contact Barrel Wire Size (AWG)* | #6 to #16 | 1/0 to #10 | #6 to #16 | #2 to #6 | 1/0 to #10 | 2/0 to 300mcm |
| Contact Barrel Wire Size (mm²)* | 13.3 to 1.3 | 53.5 to 5.3 | 13.3 to 1.3 | 33.3 to 13.3 | 53.5 to 5.3 | 67.4 to 152 |
| Housing Information | Powerpole and SB housings are manufactured using polycarbonate resin that meets UL94 V-0 requirements. Temperature range is -20° to 105°C / -4° to 221°F. | | | | | |
|  | | | | | | |
| * Reducing bushing must be used to accommodate smaller wire sizes | | | | | | |

PRODUCT INFORMATION

APP's rugged Bus bar contacts are used with the Powerpole® and SB® connector housings. The connectors attach directly to a copper bus, while offering a quick disconnect design that minimizes the expense of system assembly, replacement or repair. The Bus bar contact reduces assembly costs by facilitating the use of plug-in sub-systems and sub-system testing. Further savings are also made possible as the connectors eliminate the need for a licensed electrician to conduct field site service and repair. This efficient transmission of power makes them ideal for use in electronic cabinets. (Amperage may require de-rating for the mating wire size selected.)

To ensure high conductivity and minimal electrical loss, APP's Bus bar contacts are manufactured from solid copper and silver-plated. The contacts are threaded to provide simple attachment to a bus without the need for special tooling. The knurled shoulder of the Bus bar contact assures a secure fit, and the "D" shape guarantees proper contact orientation.

APP's rugged Bus bar contacts are designed to attach directly to a copper bus, while offering a quick disconnect design that minimizes the expense of system assembly, replacement or repair. The contacts will handle 75 amps up to 350 amps and are used with the standard APP Powerpole® and SB® housings.

To ensure high conductivity and minimal electrical loss, APP's Bus bar contacts are manufactured from solid copper and silver-plated. The contacts are threaded to provide simple attachment to a bus without the need for special tooling.

FEATURES

- **Disconnect contacts**
Provide for modular assembly or simple field repair lowering manufacturing and maintenance costs
- **Hot swap ***
Allows for repair and maintenance of components without the need for powering down equipment
- **Solid copper contacts with silver plating**
Superior conductivity for lower heating

* Tested per UL1977 - overload and resistance to ARC - Based on singlepole



PRODUCT SPECIFICATIONS

| Contact Information | PP75 | PP180 | SB® 50 | SB®120 | SB®175 | SB®350 |
|---------------------------------|---|-------------|-------------|--------------|-------------|---------------|
| Maximum Current (per contact) | 75 amps | 180 amps | 50 amps | 120 amps | 175 amps | 350 amps |
| Maximum Voltage (AC or DC) | 600 | | | | | |
| Contact Material | 99 % copper | | | | | |
| Plating | Silver | | | | | |
| Contact Resistance | <100 micro-ohms | | | | | |
| Mating Life-No Load (cycles) | 10,000 | | | | | |
| Mating Connector Information | | | | | | |
| Contact Barrel Wire Size (AWG)* | #6 to #16 | 1/0 to #10 | #6 to #16 | #2 to #6 | 1/0 to #10 | 2/0 to 300mcm |
| Contact Barrel Wire Size (mm²)* | 13.3 to 1.3 | 53.5 to 5.3 | 13.3 to 1.3 | 33.3 to 13.3 | 53.5 to 5.3 | 67.4 to 152 |
| Housing Information | Powerpole and SB housings are manufactured using polycarbonate resin that meets UL94 V-0 requirements. Temperature range is -20° to 105°C / -4° to 221°F. | | | | | |

* Reducing bushing must be used to accommodate smaller wire sizes



ORDERING INFORMATION

Bus Bar Contact

| Part Number | Description |
|-------------|------------------------------|
| 75BBS | For use with PP75 / SB50 |
| 120BBS | For use with SB120 (SB only) |
| 180BBS | For use with PP180 / SB175 |
| 350BBS | For use with SB350 (SB only) |

Powerpole® PP180 Housings

| Part Number | Description |
|-------------|----------------------|
| 1381 | PP180 Housing, Blue |
| 1381G1 | PP180 Housing, Black |
| 1381G2 | PP180 Housing, White |
| 1381G3 | PP180 Housing, Red |
| 1381G4 | PP180 Housing, Green |

SB® 175 Housings

| Part Number | Description |
|-------------|--------------------|
| 940 | SB Housing, Gray |
| 941 | SB Housing, Blue |
| 942 | SB Housing, Orange |
| 943 | SB Housing, Yellow |
| 949 | SB Housing, Red |

Lock Nuts

| Part Number | Description |
|-------------|--|
| 110G54 | For use with PP75 / SB50 / SB120 contact |
| 110G55 | For use with PP180 / SB175 contact |
| 110G73 | For use with SB350 contact |

SB® 50 Housings

| Part Number | Description |
|-------------|-------------|
| 992 | Gray |
| 992G1 | Red |
| 992G2 | Black |
| 992G4 | Blue |
| 992G5 | Yellow |
| 992G6 | Green |
| 992G7 | Orange |

SB® 350 Housings

| Part Number | Description |
|-------------|-------------|
| 906 | Gray |
| 912 | Blue |
| 913 | Red |
| 914 | Yellow |
| 931 | Green |
| 932 | Orange |

Powerpole® PP75 Housings

| Part Number | Description |
|-------------|---------------------|
| 5916 | PP75 Housing, Blue |
| 5916G4 | PP75 Housing, Black |
| 5916G5 | PP75 Housing, White |
| 5916G6 | PP75 Housing, Green |
| 5916G7 | PP75 Housing, Red |

SB® 120 Housings

| Part Number | Description |
|-------------|-------------|
| 6810G1 | Gray |
| 6810G2 | Blue |
| 6810G3 | Red |

Note: For additional Bus Bar connector designs and/or additional housing colors, please contact customer service.

HEADQUARTERS: 13 Pratts Junction Road, P.O. Box 579, Sterling, MA 01564 T:978-422-3600 F:978-422-3700

EUROPE: Rathealy Road, Fermoy Co. Cork, Ireland T:353-(0)25-32277 F:353-(0)25-32296

ASIA/PACIFIC: IDEAL Anderson Asia Pacific Ltd., Unit 922-928 Topsail Plaza, 11 On Sum Street, Shatin N.T., Hong Kong T:852-2636-0836 F:852-2635-9036

CHINA: IDEAL Anderson Technologies (Shenzhen) Ltd., Block A8 Tantou W. Ind. Par, Songgang Baoan District, Shenzhen, PR. China 51810 T: 86-755-2768-2118 F: 86-755-2768-2218

TAIWAN: IDEAL Anderson Asia Pacific Ltd., Taiwan Branch, 4F-2, No.116, Dadun 20th St., Situn District, Taichung City 407, Taiwan (R.O.C.) T: 886-4-2310-6451 F:886-4-2310-6460

www.andersonpower.com

ORDERING INFORMATION

Contacts

| Part Number | - A - | | - B - | | - C - | | - D - | - E - | | - F - | | |
|-------------|-------|------|-------|------|-------|------|-------|-------------|------|-------|------|-----|
| | in. | mm | in. | mm | in. | mm | | in. | mm | in. | mm | |
| 75BBS | 75 | 2.70 | 68.6 | 0.67 | 17.0 | 0.27 | 6.9 | #10-24 thd. | 0.04 | 1.0 | 0.08 | 2.0 |
| 120BBS | 120 | 3.03 | 77.0 | 0.44 | 11.2 | 0.38 | 9.7 | #10-24 thd. | N/A | | 0.10 | 2.5 |
| 180BBS | 180 | 4.30 | 109.2 | 1.00 | 25.4 | 0.50 | 12.7 | 1/4-20 thd. | N/A | | 0.18 | 4.6 |
| 350BBS | 350 | 5.19 | 131.8 | 0.88 | 22.4 | 0.67 | 17.0 | 3/8-16 thd. | N/A | | 0.10 | 2.5 |

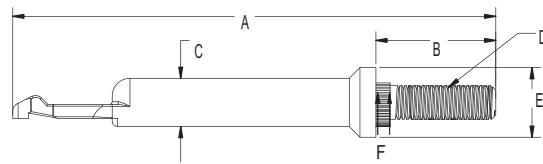

75BBS

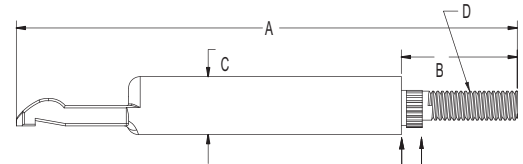

120BBS / 180BBS / 350BBS

Mounting Table

| Part Number | Amps | - E - | | - F - | | - G - | | - H - | | - J - | |
|-------------|------|-------|-------|-------|------|-------|------|-------|-----|-------------|-----------|
| | | in. | mm | in. | mm | in. | mm | in. | mm | in. | mm |
| 75BBS | 75 | 2.10 | 53.3 | 0.20 | 5.1 | 2.10 | 53.3 | 0.20 | 5.1 | 0.12 -0.050 | 3.0 -12.7 |
| 120BBS | 120 | 2.70 | 68.6 | 0.20 | 5.1 | N/A | | N/A | | 0.12 -0.77 | 3.0 -19.6 |
| 180BBS | 180 | 3.50 | 88.9 | 0.40 | 10.2 | 3.50 | 88.9 | 0.30 | 7.6 | 0.20 -0.75 | 5.0 -19.0 |
| 350BBS | 350 | 4.45 | 113.0 | 0.20 | 5.1 | N/A | | N/A | | 0.12 -0.77 | 3.0 -19.6 |

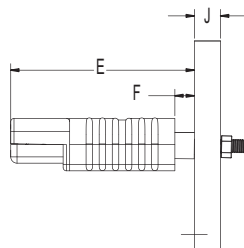

SB® View

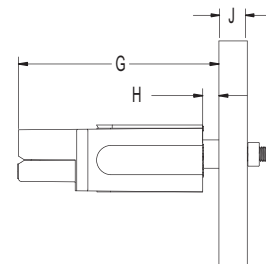

Powerpole® View

Bus Bar Layout

| Part Number | Amps | - J - | | - K - | | - L - | | - M - | |
|-------------|------|-------|------|-----------|-----------|-------|-------|-------|-------|
| | | mm | in. | mm | in. | mm | in. | mm | in. |
| 75BBS | 75 | 19.1 | 0.75 | 17.3(min) | 0.68(min) | 6.73 | 0.265 | 2.92 | 0.115 |
| 120BBS | 120 | 23.6 | 0.93 | 21.1(min) | 0.83(min) | 7.37 | 0.29 | 6.35 | 0.25 |
| 180BBS | 180 | 26.8 | 1.05 | 26.8(min) | 1.05(min) | 9.53 | 0.375 | 3.43 | 0.135 |
| 350BBS | 350 | 34.9 | 1.38 | 33.8(min) | 1.33(min) | 13.34 | 0.525 | 11.76 | 0.463 |

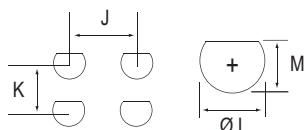

Mounting Dimensions

Lock Nuts

| Part Number | Lock Nut | - A - | | - B - | |
|-------------|-------------|-------|------|-------|------|
| | | mm | in. | mm | in. |
| 75BBS | #10-24 thd. | 10.9 | 0.43 | 4.0 | 0.16 |
| 120BBS | #10-24 thd. | 10.9 | 0.43 | 4.1 | 0.16 |
| 180BBS | 1/4-20 thd. | 12.9 | 0.51 | 6.0 | 0.23 |
| 350BBS | 3/8-16 thd. | 16.5 | 0.65 | 10.0 | 0.40 |

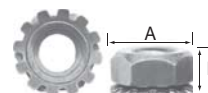



Connector Notes

For customer drawings, assembly instructions and individual data sheets, please visit www.andersonpower.com.

HEADQUARTERS: 13 Pratts Junction Road, P.O. Box 579, Sterling, MA 01564 T:978-422-3600 F:978-422-3700

EUROPE: Rathealy Road, Fermoy Co. Cork, Ireland T:353-(0)25-32277 F:353-(0)25-32296

ASIA/PACIFIC: IDEAL Anderson Asia Pacific Ltd., Unit 922-928 Topsail Plaza, 11 On Sum Street, Shatin N.T., Hong Kong T:852-2636-0836 F:852-2635-9036

CHINA: IDEAL Anderson Technologies (Shenzhen) Ltd., Block A8 Tantou W. Ind. Par, Songgang Baoan District, Shenzhen, P.R. China 51810 T: 86-755-2768-2118 F: 86-755-2768-2218

TAIWAN: IDEAL Anderson Asia Pacific Ltd., Taiwan Branch, 4F.-2, No.116, Dadun 20th St., Situn District, Taichung City 407, Taiwan (R.O.C.) T: 886-4-2310-6451 F:886-4-2310-6460

www.andersonpower.com

FEATURES

- Finger proof**
Minimizes the potential contact with live contacts, per UL 1977, section 10.2
- Mechanical keyed housings**
Prevents accidental mating of connectors operating at different voltage levels
- Ergonomic design**
Is "user friendly" during connection and disconnection of the system
- Molded side grooves**
Allows for direct panel mounting, for panel thicknesses of .048 to .062 inches (1.22 to 1.57 mm) or a panel mount bracket
- Mechanical keyed color coded housings**
Prevents accidental mating of components operating at different voltage levels
- Genderless design**
Makes assembly quick and easy and reduces number of parts stocked
- Flat wiping contact system**
Allows for minimal contact resistance at high current, wiping action cleans contact surface during disconnection
- UL approved for current interrupt**
Safe for "Hot Plug" of battery power
- UL94 V-0 housing material**
Provides security in knowledge that the connector chosen meets strict UL flammability ratings

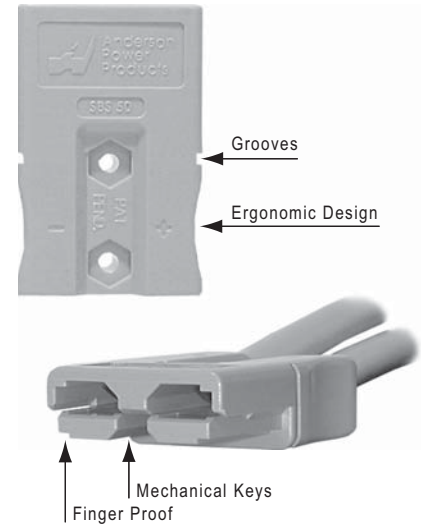

PRODUCT RANGE

| | |
|--|--------------|
| UL Current Rating (Amperes)* | 50 |
| UL Voltage Ratings (Volts) | 600* |
| Contact Barrel Wire Size (AWG) | #6 to #16 |
| Maximum Wire Insulation Diameter (inches) | 0.44 |
| (mm) | 11.2 |
| AVG Contact Resistance* (micro-ohms) | 200 |
| Insulation Withstanding | 2200 |
| Test Voltage (Volts AC/DC) | |
| Contact Retention Force (lbf) | 50 |
| Life | |
| a. No load (Contact/Disconnect Cycles) | To 10,000 |
| b. Under Load (Hot Plug 250 cycles @ 120V) | 50A |
| Avg. Connection/Disconnect (lbf) | 15 |
| Operating Temperature Range °C** | -20° to 105° |
| Flammability Rating of Housing Material | UL94 V-0 |



* UL Rated for 65°C largest wire or cable
 ** Contact factory for higher temperature rated connector

Recommended Voltage Key Color Code

| | | | | | | |
|---------|-----|------|------|-------|-------|-------|
| Voltage | 24V | 36V | 48V | 80V | 96V | 192V |
| Color | Red | Gray | Blue | Black | Brown | White |

PRODUCT INFORMATION

Anderson Power Products (APP), a leader in interconnect solutions, offers the highly-durable SBS50 Finger Proof connector. This 2 pole housing, offers APP customers a finger proof design. The design minimizes contact with live contacts, per UL 1977 and UL 60950 regulations, for systems operating over 50 volts, where risk of shock can be health threatening.

The SBS50's slim, contoured ergonomic design allows the operator greater ease when connecting and disconnecting. This along with APP's flat wipe contact technology, make hot plugging and unplugging easy and safe while using minimal real estate. These housings are also keyed to prevent accidental mating of components operating at different voltage levels. Molded side grooves allow secure panel mounting for panel thickness of .048 to .062 inches (1.22 to 1.57 mm).



File No. E26226

This product is patented

All Data Subject To Change Without Notice

HEADQUARTERS: 13 Pratts Junction Road, P.O. Box 579, Sterling, MA 01564 T:978-422-3600 F:978-422-3700

EUROPE: Rathealy Road, Fermoy Co. Cork, Ireland T:353-(0)25-32277 F:353-(0)25-32296

ASIA/PACIFIC: IDEAL Anderson Asia Pacific Ltd., Unit 922-928 Topsail Plaza, 11 On Sum Street, Shatin N.T., Hong Kong T:852-2636-0836 F:852-2635-9036

CHINA: IDEAL Anderson Technologies (Shenzhen) Ltd., Block A8 Tantou W. Ind. Par, Songgang Baoan District, Shenzhen, PR. China 51810 T: 86-755-2768-2118 F: 86-755-2768-2218

TAIWAN: IDEAL Anderson Asia Pacific Ltd., Taiwan Branch, 4F.-2, No.116, Dadun 20th St., Situn District, Taichung City 407, Taiwan (R.O.C.) T: 886-4-2310-6451 F:886-4-2310-6460

www.andersonpower.com

The Patented SBS0 is designed for high voltage applications where personal safety is critical. The connector meets the accessibility requirements of UL1977 section 10.2 and is recommended for over 50 volts.

The slim, ergonomic design, along with Anderson's flat wipe contact technology makes hot plugging and unplugging easy and safe. The SBS™ 50 is manufactured using the same high quality materials that provide APP customers the robustness needed for systems demanding reliability and longevity.

Applications for this connector include: AC & DC power distribution, uninterruptible power supplies (UPS) and traction batteries.

FEATURES

- Finger proof**
Minimizes the potential contact with live contacts, per UL 1977, section 10.2
- Mechanical keyed housings**
Prevents accidental mating of connectors operating at different voltage levels
- Ergonomic design**
Is "user friendly" during connection and disconnection of the system
- Molded side grooves**
Allows for direct panel mounting, for panel thicknesses of .048 to .062 inches (1.22 to 1.57 mm) or a panel mount bracket

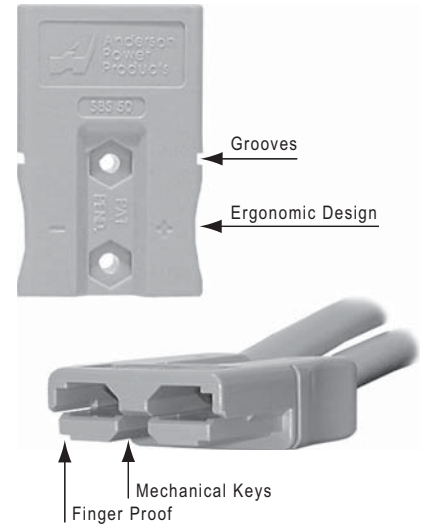

PRODUCT SPECIFICATIONS

| Connector Model | SBS 50 | Connector Model | SBS 50 |
|--|-----------|---|--------------|
| UL Current Rating (Amperes) | 50 | Life | |
| UL Voltage Ratings (Volts) | 600* | a. No load (Contact/Disconnect Cycles) | To 10,000 |
| Contact Barrel Wire Size (AWG) | #6 to #16 | b. Under Load (Hot Plug 250 cycles @ 120V) | 50A |
| Maximum Wire Insulation Diameter (inches) | 0.44 | Avg. Connection/Disconnect (lbf) | 15 |
| (mm) | 11.2 | Operating Temperature Range °C** | -20° to 105° |
| AVG Contact Resistance* (micro-ohms) | 200 | °F | -4° to 221° |
| Insulation Withstanding Test Voltage (Volts AC/DC) | 2200 | Flammability Rating of Housing Material | UL94 V-0 |
| Contact Retention Force (lbf) | 50 | Recommended Voltage Key Color Code | |
| | | Voltage 24V 36V 48V 80V 96V 192V | |
| | | Color Red Gray Blue Black Brown White | |
| | | * UL Rated for 65°C largest wire or cable / ** Contact factory for higher temperature rated connector / SB [®] , UL and CSA Reference: This equipment is an Underwriters Laboratories Inc [®] recognized component. It is also listed by the Canadian Standards Association as certified. | |

ORDERING INFORMATION

2 Pole Housing & 50 amp Contacts

| Part Number | Housing Color | Wire AWG |
|-----------------|---------------|----------|
| SBS50GRA#6 | Gray | #6 |
| SBS50GRA#10/12 | Gray | #10/12 |
| SBS50BLU#6 | Blue | #6 |
| SBS50BLU#10/12 | Blue | #10/12 |
| SBS50RED #6 | Red | #6 |
| SBS50RED #10/12 | Red | #10/12 |
| SBS50BLK #6 | Black | #6 |
| SBS50BLK #10/12 | Black | #10/12 |
| SBS50BRN#6 | Brown | #6 |
| SBS50BRN#10/12 | Brown | #10/12 |
| SBS50WHT#6 | White | #6 |
| SBS50WHT#10/12 | White | #10/12 |

Note: For additional colors please contact customer service

Housings Only

| Part Number | Description |
|-------------|-------------|
| SBS50GRA | Gray |
| SBS50BLU | Blue |
| SBS50RED | Red |
| SBS50BLK | Black |
| SBS50BRN | Brown |
| SBS50WHT | White |

50 amp Contacts

| Part Number | Description | Wire AWG |
|-------------|-------------------------|----------|
| 1339G2 | Contact set (2)-low det | #6 |
| 1339G3 | Contact set (2)-low det | #10/12 |

Accessories

| Part Number | Description |
|---------------|--|
| SBS50-HDL-Red | Handle & hardware-red |
| 990 | Cable clamp & hardware-self attaching-2C |
| 990G1 | Cable clamp & hardware-screw mounting-2C |
| 5905 | Cable clamp-1 twin conductor with hardware |
| 1466G1 | Panel mount bracket |

Bushings

| Part Number | Description | Wire AWG |
|-------------|-----------------|--------------|
| 5912 | Use with 1339G2 | #6 to #8 |
| 5910 | Use with 1339G2 | #6 to #10/12 |
| 5913 | Use with 1339G2 | #6 to #14/16 |

HEADQUARTERS: 13 Pratts Junction Road, P.O. Box 579, Sterling, MA 01564 T:978-422-3600 F:978-422-3700

EUROPE: Rathealy Road, Fermoy Co. Cork, Ireland T:353-(0)25-32277 F:353-(0)25-32296

ASIA/PACIFIC: IDEAL Anderson Asia Pacific Ltd., Unit 922-928 Topsail Plaza, 11 On Sum Street, Shatin N.T., Hong Kong T:852-2636-0836 F:852-2635-9036

CHINA: IDEAL Anderson Technologies (Shenzhen) Ltd., Block A8 Tantou W. Ind. Par, Songgang Baoan District, Shenzhen, P.R. China 51810 T: 86-755-2768-2118 F: 86-755-2768-2218

TAIWAN: IDEAL Anderson Asia Pacific Ltd., Taiwan Branch, 4F.-2, No.116, Dadun 20th St., Situn District, Taichung City 407, Taiwan (R.O.C.) T: 886-4-2310-6451 F:886-4-2310-6460

www.andersonpower.com

ORDERING INFORMATION

Tooling

| Part Number | Description |
|-------------|-----------------------------|
| 1309G4 | Hand tool |
| 1387G1 | Pneumatic tool |
| 1388G6 | - die for #6 to #16 AWG |
| 1388G7 | - die for #10 to #12 AWG |
| 1389G9 | - locator for #6 to #12 AWG |

TEMPERATURE RISE CHART

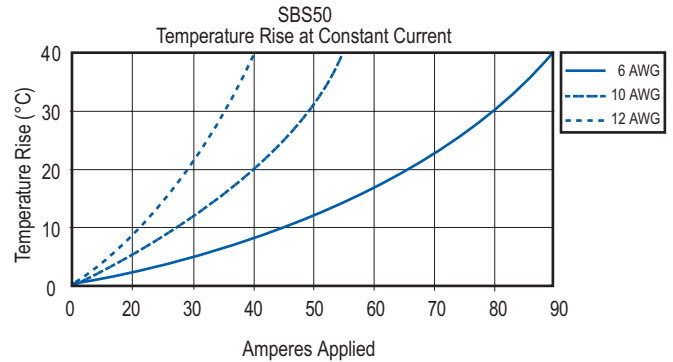

DIMENSIONS

Housing

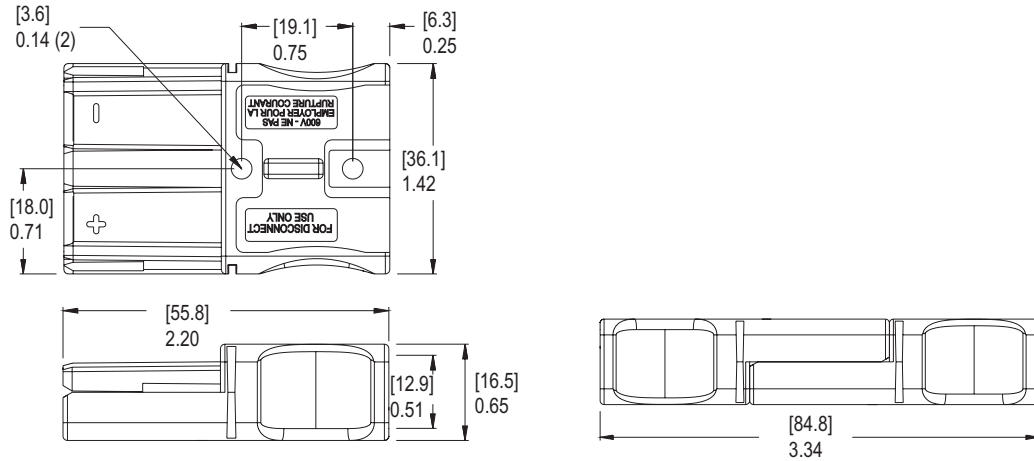

Panel Mounting Bracket

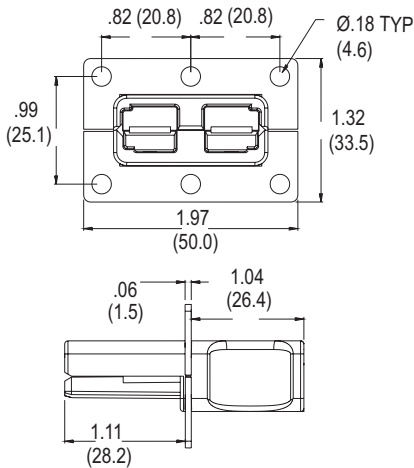

Panel Cutout With A Mounting Bracket

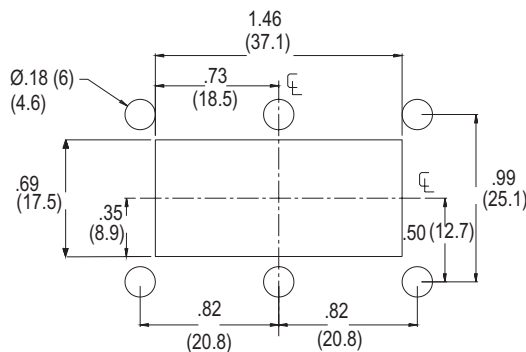

Panel Cutout Without A Mounting Bracket

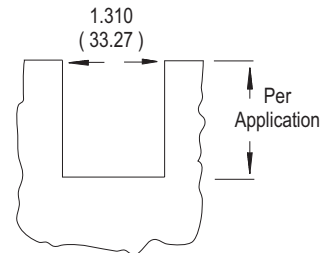

CSA Certified
File No. LR25154



File No. E26226

This product is patented

All Data Subject To Change Without Notice

HEADQUARTERS: 13 Pratts Junction Road, P.O. Box 579, Sterling, MA 01564 T:978-422-3600 F:978-422-3700

EUROPE: Rathealy Road, Fermoy Co. Cork, Ireland T:353-(0)25-32277 F:353-(0)25-32296

ASIA/PACIFIC: IDEAL Anderson Asia Pacific Ltd., Unit 922-928 Topsail Plaza, 11 On Sum Street, Shatin N.T., Hong Kong T:852-2636-0836 F:852-2635-9036

CHINA: IDEAL Anderson Technologies (Shenzhen) Ltd., Block A8 Tantou W. Ind. Par, Songgang Baoan District, Shenzhen, P.R. China 51810 T: 86-755-2768-2118 F: 86-755-2768-2218

TAIWAN: IDEAL Anderson Asia Pacific Ltd., Taiwan Branch, 4F-2, No.116, Dadun 20th St., Situn District, Taichung City 407, Taiwan (R.O.C.) T: 886-4-2310-6451 F:886-4-2310-6460

www.andersonpower.com



Connector Notes

For customer drawings, assembly instructions and individual data sheets, please visit www.andersonpower.com.

HEADQUARTERS: 13 Pratts Junction Road, P.O. Box 579, Sterling, MA 01564 T:978-422-3600 F:978-422-3700

EUROPE: Rathealy Road, Fermoy Co. Cork, Ireland T:353-(0)25-32277 F:353-(0)25-32296

ASIA/PACIFIC: IDEAL Anderson Asia Pacific Ltd., Unit 922-928 Topsail Plaza, 11 On Sum Street, Shatin N.T., Hong Kong T:852-2636-0836 F:852-2635-9036

CHINA: IDEAL Anderson Technologies (Shenzhen) Ltd., Block A8 Tantou W. Ind. Par, Songgang Baoan District, Shenzhen, P.R. China 51810 T: 86-755-2768-2118 F: 86-755-2768-2218

TAIWAN: IDEAL Anderson Asia Pacific Ltd., Taiwan Branch, 4F.-2, No.116, Dadun 20th St., Situn District, Taichung City 407, Taiwan (R.O.C.) T: 886-4-2310-6451 F:886-4-2310-6460

www.andersonpower.com

FEATURES

- Mechanical keyed housings**
Prevents accidental mating of components operating at different voltage levels
- Single-piece housing and unitized construction**
Provides industrial quality and durability
- PCB mounted Quick disconnect**
Avoids the need for unfastening ring type terminals
- Straight and right angle terminal**
Provides flexibility of parallel or perpendicular mounting to the PCB
- Genderless design**
Makes assembly quick and easy and reduces number of parts stocked
- Flat wiping contact system**
Allows for minimal contact resistance at high current, wiping action cleans contact surface during disconnection
- Silver plated contacts**
Offers greater longevity when using high power, elevated temperature applications
- UL approved for current interrupt**
Safe for "Hot Plug" of battery power
- Wide product range - for 50, 120, 175 and 350 amps**
Allows versatility to choose product best suited to design requirements
- UL94 V-0 housing material**
Provides security in knowledge that the connector chosen meets strict UL flammability ratings



PRODUCT RANGE

| | |
|---|----------------|
| UL Current Rating (Amperes)* | 50* to 350* |
| UL Voltage Ratings (Volts) | 600* |
| Contact Barrel Wire Size (AWG) | #16 to 300 mcm |
| (mm ²) | 1.3 to 152.0 |
| Maximum Wire Insulation Diameter (inches) | 0.44 to 1.10 |
| (mm) | 11.2 to 27.9 |
| AVG Contact Resistance* (micro-ohms) | 200 to 50 |
| Insulation Withstanding Test Voltage (Volts AC/DC) | 2200 |
| Contact Retention Force (lbf) | 50 to 500 |
| Life | |
| a. No load (Contact/Disconnect Cycles) | To 10,000 |
| b. Under Load (Hot Plug) Max Amps (250 cycles @ 120V) | 50A to 100A |
| Avg. Connection/Disconnect (lbf) | 15 to 35 |
| Operating Temperature Range °C** | -20° to 105° |
| °F | -4° to 221° |
| Flammability Rating of Housing Material | UL94 V-0 |



* UL Rated for 65°C largest wire or cable size
 ** Contact factory for higher temperature rated connectors

Recommended Voltage Key Color Code

| | | | | | | | | | | |
|---------|--------|--------|-----|------|------|-------|-------|-------|--------|-------|
| Voltage | 12V | 18V | 24V | 36V | 48V | 72V | 80V | 96V | 120V | 144V |
| Color | Yellow | Orange | Red | Gray | Blue | Green | Black | Brown | Purple | White |

PRODUCT INFORMATION

Invented by Anderson Power Products®, the innovative SB® connectors provide cost-effective reliability, design flexibility and mistake-proof capability for your products' manufacture, installation and maintenance. APP's 2 & 3 pole connectors are available for 50, 120, 175 and 350 amp ratings for use to 600 Volts continuous AC or DC operation. There are SB® connectors for many applications and wire sizes, #16 (1.3 mm²) to 300 mcm (152.0 mm²). Mechanical keys ensure connectors will only mate with connectors of the same color. Different color housings are selected to identify voltages, thus preventing mismatching of the power supply system.

The housings are interchangeable and genderless interconnects. Insert contacts into housings and plug together for a clever, simple and low-cost solution to power interconnection. Low-detent contacts are also offered for low insertion/withdrawal force applications. Contacts are available in reeled and loose piece designs to support all production needs from very high volumes to engineering prototype and low-volume customized products.

Markets: UPS Systems, Telecommunications, Forklift Trucks, Wheelchairs, Electric Vehicles, Chargers, Power Electronics & Much More.



© CSA Certified
 File No. LR25154



File No. E26226

All Data Subject To Change Without Notice

HEADQUARTERS: 13 Pratts Junction Road, P.O. Box 579, Sterling, MA 01564 T:978-422-3600 F:978-422-3700

EUROPE: Rathealy Road, Fermoy Co. Cork, Ireland T:353-(0)25-32277 F:353-(0)25-32296

ASIA/PACIFIC: IDEAL Anderson Asia Pacific Ltd., Unit 922-928 Topsail Plaza, 11 On Sum Street, Shatin N.T., Hong Kong T:852-2636-0836 F:852-2635-9036

CHINA: IDEAL Anderson Technologies (Shenzhen) Ltd., Block A8 Tantou W. Ind. Par, Songgang Baoan District, Shenzhen, P.R. China 51810 T: 86-755-2768-2118 F: 86-755-2768-2218
 TAIWAN: IDEAL Anderson Asia Pacific Ltd., Taiwan Branch, 4F.-2, No.116, Dadun 20th St., Situn District, Taichung City 407, Taiwan (R.O.C.) T: 886-4-2310-6451 F:886-4-2310-6460

www.andersonpower.com

The innovative SB[®] connectors provide cost-effective reliability, design flexibility and safety for your products' manufacture, installation and maintenance.

APP's 2 pole connector is available with a 50 amp rating, 600 Volts continuous AC or DC operation. There are SB[®] connectors for many applications and wire sizes, #6 to #16 AWG (13.3 to 1.3 mm²). Mechanical keys ensure connectors will only mate with connectors of the same color. Different color housings are selected to identify voltages, thus preventing mismatching of the power supply system.

FEATURES

- **Mechanical keyed housings**
Prevents accidental mating of components operating at different voltage levels
- **Single-piece housing and unitized construction**
Provides industrial quality and durability
- **Genderless design**
Makes assembly quick and easy and reduces number of parts stocked



PRODUCT SPECIFICATIONS

| Connector Model | SB [®] 50 | Connector Model | SB [®] 50 |
|---|--------------------------|--|-------------------------------------|
| UL Current Rating (Amperes)* | 50* | Life | |
| UL Voltage Ratings (Volts) | 600* | a. No load (Contact/Disconnect Cycles) | To 10,000 |
| Contact Barrel Wire Size (AWG) (mm ²) | #6 to #16 13.3 to 1.3 | b. Under Load (Hot Plug 250 cycles @ 120V) | 50A |
| Maximum Wire Insulation Diameter (inches) (mm) | 0.44 11.2 | Avg. Connection/Disconnect (lbf) | 10 - low detent 15 - high detent |
| AVG Contact Resistance* (micro-ohms) | 200 | Operating Temperature Range °C** °F | -20° to 105° -4° to 221° |
| Insulation Withstanding Test Voltage (Volts AC/DC) | 2200 | Flammability Rating of Housing Material | UL94 V-0 |
| Contact Retention Force (lbf) | 50 | | |



* UL Rated for 65°C largest wire or cable size
** Contact factory for higher temperature rated connector
SB[®], UL and CSA Reference: This equipment is an Underwriters Laboratories Inc[®] recognized component. It is also listed by the Canadian Standards Association as certified.

ORDERING INFORMATION

2 Pole Housing & 50 amp Contacts

| Part Number | Housing Color | Wire AWG | Wire sq. mm |
|-------------|---------------|----------|-------------|
| 6319 | Gray | #6 | 13.3 |
| 6319G1 | Gray | #10/12 | 5.3/3.3 |
| 6331G1 | Red | #6 | 13.3 |
| 6331G2 | Red | #10/12 | 5.3/3.3 |
| 6331G3 | Black | #6 | 13.3 |
| 6331G4 | Black | #10/12 | 5.3/3.3 |
| 6331G5 | Blue | #6 | 13.3 |
| 6331G6 | Blue | #10/12 | 5.3/3.3 |
| 6331G7 | Yellow | #6 | 13.3 |
| 6331G8 | Yellow | #10/12 | 5.3/3.3 |
| 6331G9 | Green | #6 | 13.3 |
| 6331G10 | Green | #10/12 | 5.3/3.3 |
| 6331G11 | Orange | #6 | 13.3 |
| 6331G12 | Orange | #10/12 | 5.3/3.3 |

* LD - low detent or HD - high detent
Note: For additional colors please contact customer service

Housings Only

| Part Number | Description |
|-------------|-------------|
| 992 | Gray |
| 992G1 | Red |
| 992G2 | Black |
| 992G4 | Blue |
| 992G5 | Yellow |
| 992G6 | Green |
| 992G7 | Orange |

50 amp Contacts*

| Part Number | Description | Wire AWG | Wire sq. mm |
|-------------|----------------------|----------|-------------|
| 903G1 | Contact set (2) 5900 | #6 | 13.3 |
| 904G1 | Contact set (2) 5915 | #10/12 | 5.3/3.3 |
| 5900 | Individual - HD | #6 | 13.3 |
| 1307 | Individual - LD | #6 | 13.3 |
| 5952 | Individual - HD | #8 | 8.4 |
| 5953 | Individual - LD | #10/12 | 5.3/3.3 |
| 5914 | Individual - HD | #10 | 5.26 |
| 5915 | Individual - HD | #10/12 | 5.3/3.3 |

50 amp contacts continued

| Part Number | Description | Wire AWG | Wire sq. mm |
|-------------|-------------------|----------|-------------|
| 265G1 | Reel, silver - HD | #6/8 | 13.3/8.4 |
| 265G2 | Reel, silver - HD | #10/12 | 5.3/3.3 |
| 265G3 | Reel, silver - LD | #6/8 | 13.3/8.4 |
| 265G4 | Reel, silver - LD | #10/12 | 5.3/3.3 |
| 265G5 | Reel, tin - HD | #6/8 | 13.3/8.4 |
| 265G6 | Reel, tin - HD | #10/12 | 5.3/3.3 |
| 265G7 | Reel, tin - LD | #6/8 | 13.3/8.4 |
| 265G8 | Reel, tin - LD | #10/12 | 5.3/3.3 |
| 75BBS | Bus bar contact | N/A | N/A |

Accessories

| Part Number | Description |
|--------------|--|
| SB50-HDL-Red | Handle & hardware, red |
| 134G1 | Dust cover, red |
| 990 | Cable clamp & hardware, self attaching, 2C |
| 990G2 | Cable clamp, 2 single conductors |

HEADQUARTERS: 13 Pratts Junction Road, P.O. Box 579, Sterling, MA 01564 T:978-422-3600 F:978-422-3700

EUROPE: Rathealy Road, Fermoy Co. Cork, Ireland T:353-(0)25-32277 F:353-(0)25-32296

ASIA/PACIFIC: IDEAL Anderson Asia Pacific Ltd., Unit 922-928 Topsail Plaza, 11 On Sum Street, Shatin N.T., Hong Kong T:852-2636-0836 F:852-2635-9036

CHINA: IDEAL Anderson Technologies (Shenzhen) Ltd., Block A8 Tantou W. Ind. Par, Songgang Baoan District, Shenzhen, PR. China 51810 T: 86-755-2768-2118 F: 86-755-2768-2218

TAIWAN: IDEAL Anderson Asia Pacific Ltd., Taiwan Branch, 4F-2, No.116, Dadun 20th St., Situn District, Taichung City 407, Taiwan (R.O.C.) T: 886-4-2310-6451 F:886-4-2310-6460

www.andersonpower.com

ORDERING INFORMATION

accessories continued

| Part Number | Description |
|-------------|--|
| 990G1 | Cable clamp & hardware-screw mounting-2C |
| 5905 | Cable clamp-1 twin conductor with hardware |
| 110G57 | Lock nut for use with bus bar contact |

Bushings

| Part Number | Description | Reduces From AWG | sq. mm |
|-------------|-----------------------|------------------|-----------------|
| 5910 | Use with 5900 or 1307 | #6 to #10/12 | 13.3 to 5.3/3.3 |
| 5912 | Use with 5900 or 1307 | #6 to #8 | 13.3 to 8.4 |
| 5913 | Use with 5900 or 1307 | #6 to #14/16 | 13.3 to 2.1/1.3 |

Tooling

| Part Number | Description |
|-------------|---------------------------------|
| 1309G4 | Hand tool |
| 1387G1 | Pneumatic tool |
| 1388G6 | - die for #6 to #16 AWG |
| 1388G7 | - die for #10 to #12 AWG |
| 1389G6 | - locator for #6 to #16 AWG |
| 1389G7 | - locator for #10 to #12 AWG |
| 260G16 | Applicator only (110V & 220V) |
| * | Applicator & Press (220V, 50Hz) |
| * | Press only (110V, 60Hz) |

* Consult factory

DIMENSIONS

Housing

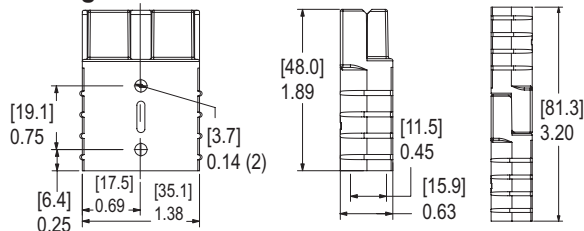

Bus Bar Layout

| Part Number | - J - | - K - | - L - | - M - |
|-------------|-----------|---------------------|------------|------------|
| | mm in. | mm in. | mm in. | mm in. |
| 75BBS | 19.1 0.75 | 17.3(min) 0.68(min) | 6.73 0.265 | 2.92 0.115 |

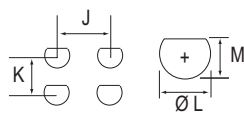

Mounting Dimensions

Bus Bar Mounting Table

| Part Number | -E- | -F- |
|-------------|-----------|-----------|
| | mm in. | mm in. |
| 75BBS | 53.3 2.10 | 5.10 0.20 |

| Part Number | -J- |
|-------------|------------------------|
| | mm in. |
| 75BBS | 3.0 - 12.7 0.12 - 0.50 |

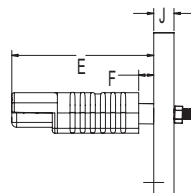

TEMPERATURE RISE CHARTS

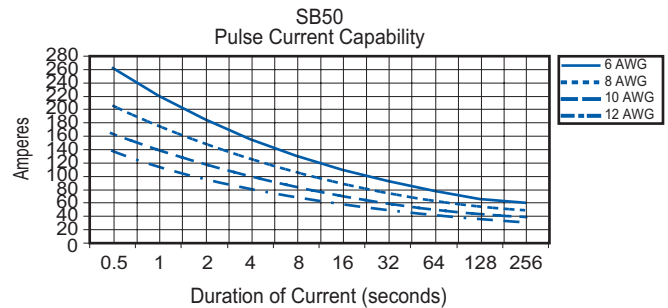
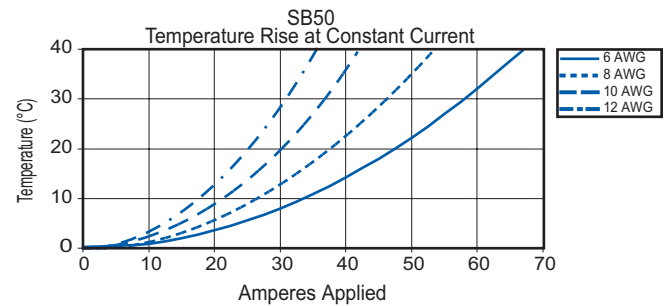

Contacts

| Part Number | -A- | -B- | -C- | -D- | -E- |
|-------------|---------------------|----------|----------|-----------|----------|
| | mm in. | mm in. | mm in. | mm in. | mm in. |
| 1307 | 30.0 1.18 | 7.2 0.28 | 5.6 0.22 | 11.4 0.45 | 7.1 0.28 |
| 5900 | 30.0 1.18 | 7.2 0.28 | 5.6 0.22 | 11.4 0.45 | 7.1 0.28 |
| 5914 | 29.7 1.17 | 4.8 0.19 | 3.5 0.14 | 11.4 0.45 | 7.1 0.28 |
| 5915 | 30.0 1.18 | 7.2 0.28 | 3.5 0.14 | 11.4 0.45 | 7.1 0.28 |
| 5952 | 30.0 1.18 | 7.2 0.28 | 4.7 0.19 | 11.4 0.45 | 7.1 0.28 |
| 5953 | 30.0 1.18 | 7.2 0.28 | 3.5 0.14 | 11.4 0.45 | 7.1 0.28 |
| 904G1 | 30.0 1.18 | 7.2 0.28 | 3.5 0.14 | 11.4 0.45 | 7.1 0.28 |
| 903G1 | 30.0 1.18 | 7.2 0.28 | 5.6 0.22 | 11.4 0.45 | 7.1 0.28 |
| 265G1 | 31.8 1.25 | 9.1 0.36 | 9.1 0.36 | 22.9 0.90 | 8.1 0.32 |
| 265G2 | 31.8 1.25 | 7.4 0.29 | 6.9 0.27 | 22.9 0.90 | 8.1 0.32 |
| 265G3 | 31.0 1.22 | 9.1 0.36 | 9.1 0.36 | 22.9 0.90 | 8.1 0.32 |
| 265G4 | 31.0 1.22 | 7.4 0.29 | 6.9 0.27 | 22.9 0.90 | 8.1 0.32 |
| 265G5 | 31.8 1.25 | 9.1 0.36 | 9.1 0.36 | 22.9 0.90 | 8.1 0.32 |
| 265G6 | 31.8 1.25 | 7.4 0.29 | 6.9 0.27 | 22.9 0.90 | 8.1 0.32 |
| 265G7 | 31.0 1.22 | 9.1 0.36 | 9.1 0.36 | 22.9 0.90 | 8.1 0.32 |
| 265G8 | 31.0 1.22 | 7.4 0.29 | 6.9 0.27 | 22.9 0.90 | 8.1 0.32 |
| 75BBS | See Bus Bar Section | | | | |

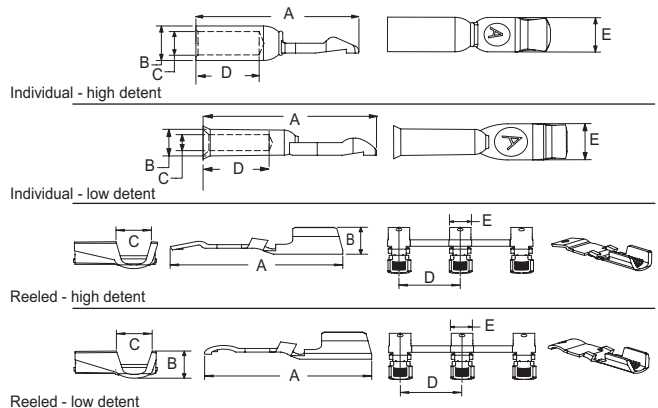

The innovative SB[®] connectors provide cost-effective reliability, design flexibility and safety for your products' manufacture, installation and maintenance.

APP's 2 pole connector is available with a 120 amp rating, 600 Volts continuous AC or DC operation. There are SB[®] connectors for many applications and wire sizes, #2 to #6 AWG (33.6 to 13.3 mm²). Mechanical keys ensure connectors will only mate with connectors of the same color. Different color housings are selected to identify voltages, thus preventing mismatching of the power supply system.

FEATURES

- **Molded side grooves**
Allows for a secure panel mounting fit
- **Mechanical keyed housings**
Prevents accidental mating of components operating at different voltage levels
- **Single-piece housing and unitized construction**
Provides industrial quality and durability

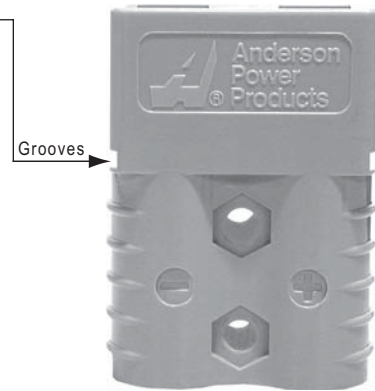

PRODUCT SPECIFICATIONS

| Connector Model | SB [®] 120 | Connector Model | SB [®] 120 |
|--|---------------------|--|---------------------|
| UL Current Rating (Amperes)* | 120* | Life | |
| UL Voltage Ratings (Volts) | 600* | a. No load (Contact/Disconnect Cycles) | To 10,000 |
| Contact Barrel Wire Size (AWG) | #2 to #6 | b. Under Load (Hot Plug 250 cycles @ 120V) | 60A |
| (mm ²) | 33.3 to 13.3 | Avg. Connection/Disconnect (lbf) | 20 |
| Maximum Wire Insulation Diameter (inches) | 0.575 | Operating Temperature Range °C** | -20° to 105° |
| (mm) | 14.6 | °F | -4° to 221° |
| AVG Contact Resistance* (micro-ohms) | 136 | Flammability Rating of Housing Material | UL94 V-0 |
| Insulation Withstanding Test Voltage (Volts AC/DC) | 2200 | | |
| Contact Retention Force (lbf) | 100 | | |



* UL Rated for 75°C largest wire or cable size
 ** Contact factory for higher temperature rated connector
 SB[®], UL and CSA Reference: This equipment is an Underwriters Laboratories Inc[®] recognized component. It is also listed by the Canadian Standards Association as certified.

ORDERING INFORMATION

2 Pole Housing & 120 amp Contacts

| Part Number | Housing Color | Wire | |
|-------------|---------------|------|--------|
| | | AWG | sq. mm |
| 6800G1 | Gray | #2 | 33.6 |
| 6801G1 | Blue | #2 | 33.6 |
| 6802G1 | Red | #2 | 33.6 |
| 6800G2 | Gray | #4 | 21.1 |
| 6801G2 | Blue | #4 | 21.1 |
| 6802G2 | Red | #4 | 21.1 |
| 6800G3 | Gray | #6 | 13.3 |
| 6801G3 | Blue | #6 | 13.3 |
| 6802G3 | Red | #6 | 13.3 |

Housing Only

| Part Number | Description |
|-------------|--------------|
| 6810G1 | Gray housing |
| 6810G2 | Blue housing |
| 6810G3 | Red housing |

120 amp Contacts

| Part Number | Description | Wire | |
|-------------|-----------------|------|--------|
| | | AWG | sq. mm |
| 6811G1 | Contact set (2) | #2 | 33.6 |
| 6811G2 | Contact set (2) | #4 | 21.1 |
| 6811G3 | Contact set (2) | #6 | 13.3 |
| 120BBS | Bus Bar | N/A | N/A |

Bushings

| Part Number | Description | Wire | |
|-------------|-----------------|----------|-----------|
| | | AWG | sq. mm |
| 5919 | Use with 6811G1 | #2 to #4 | 33.6/21.2 |
| 5920 | Use with 6811G1 | #2 to #6 | 33.6/13.3 |
| 5921 | Use with 6811G1 | #2 to #8 | 33.6/8.4 |

Accessories

| Part Number | Description |
|---------------|---|
| SB120-HDL-RED | SB handle with hardware-red |
| 981G1 | Cable clamp for 2 single conductor cables |
| 110G57 | Lock nut for use with Bus bar contact |
| 134G4 | Dust cover, red |
| 1467G1 | Panel mount bracket, set (2) |
| 981G2 | Twin conduit cable clamp |

Tooling

| Part Number | Description |
|-------------|---------------------------|
| 1368 | Hand tool - #2 to #8 |
| 1387G1 | Pneumatic tool - #2 to #8 |
| 1388G4 | - die for #2 to #8 |
| 1389G4 | - locator #2 to #8 |

Note: For additional colors please contact customer service

HEADQUARTERS: 13 Pratts Junction Road, P.O. Box 579, Sterling, MA 01564 T:978-422-3600 F:978-422-3700

EUROPE: Rathealy Road, Fermoy Co. Cork, Ireland T:353-(0)25-32277 F:353-(0)25-32296

ASIA/PACIFIC: IDEAL Anderson Asia Pacific Ltd., Unit 922-928 Topsail Plaza, 11 On Sum Street, Shatin N.T., Hong Kong T:852-2636-0836 F:852-2635-9036

CHINA: IDEAL Anderson Technologies (Shenzhen) Ltd., Block A8 Tantou W. Ind. Par, Songgang Baoan District, Shenzhen, PR. China 51810 T: 86-755-2768-2118 F: 86-755-2768-2218

TAIWAN: IDEAL Anderson Asia Pacific Ltd., Taiwan Branch, 4F.-2, No.116, Dadun 20th St., Situn District, Taichung City 407, Taiwan (R.O.C.) T: 886-4-2310-6451 F:886-4-2310-6460

DIMENSIONS

Housing

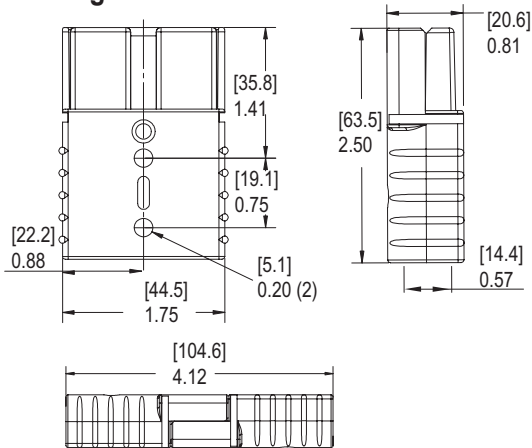

Contacts

| Part Number | -A- | -B- | -C- | -D- |
|-------------|-----------|-----------|----------|----------------|
| | mm in. | mm in. | mm in. | mm in. |
| 6811G1 | 50.8 2.00 | 11.1 0.44 | 8.7 0.34 | 21.6 0.85 |
| 6811G2 | 50.8 2.00 | 11.1 0.44 | 7.5 0.30 | 21.6 0.85 |
| 6811G3 | 50.8 2.00 | 11.1 0.44 | 5.6 0.22 | 21.6 0.85 |
| 120BBS | 77.0 3.03 | 11.2 0.44 | 9.5 0.38 | N/A #10-24Thd. |

| Part Number | Contact Detent | -E- | -F- | -J- | -K- |
|-------------|----------------|-----------|----------|-----------|----------------------|
| | | mm in. | mm in. | mm in. | mm in. |
| 6811G1 | Low | 10.4 0.41 | N/A | N/A | N/A |
| 6811G2 | Low | 10.4 0.41 | N/A | N/A | N/A |
| 6811G3 | Low | 10.4 0.41 | N/A | N/A | N/A |
| 120BBS | N/A | 68.6 2.70 | 5.1 0.20 | 23.6 0.93 | 21.1 (min) 0.83(min) |

| Part Number | Contact Detent | -L- | -M- |
|-------------|----------------|-----------|-----------|
| | | mm in. | mm in. |
| 120BBS | N/A | 7.37 0.29 | 6.35 0.25 |

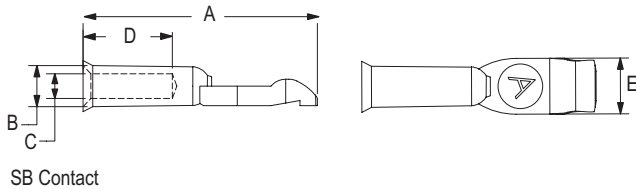

SB Contact

TEMPERATURE RISE CHARTS

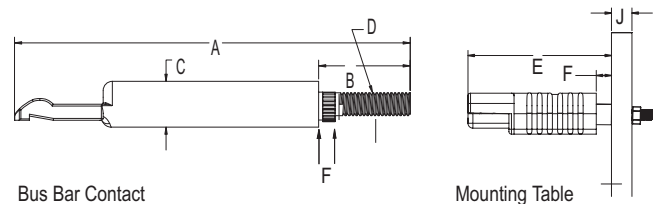
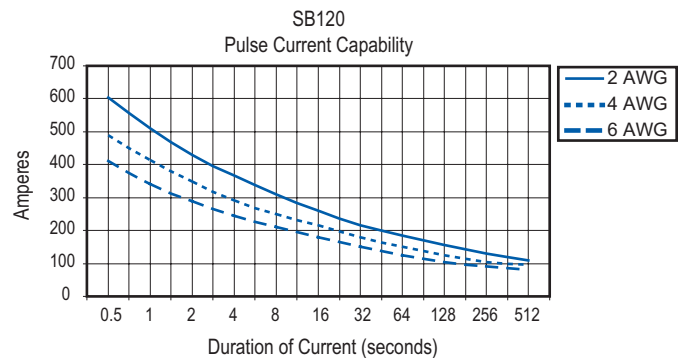
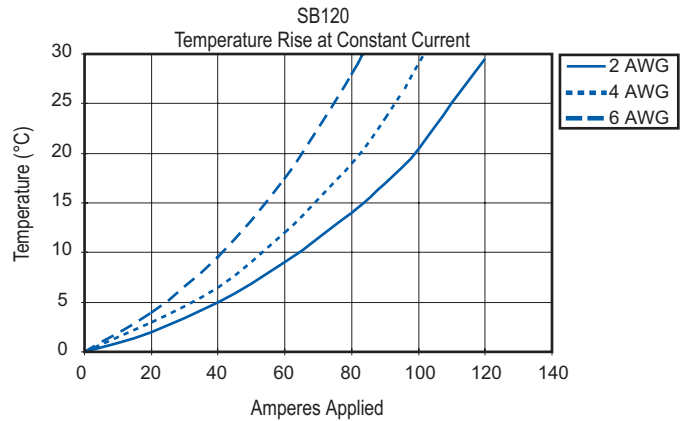

Bus Bar Contact

Mounting Table

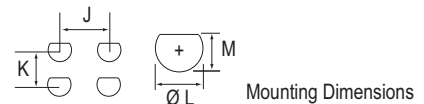

Mounting Dimensions

The innovative SB[®] connectors provide cost-effective reliability, design flexibility and safety for your products' manufacture, installation and maintenance.

APP's 2 & 3 pole connectors are available with a 175 amp rating, 600 Volts continuous AC or DC operation. There are SB[®] connectors for many applications and wire sizes, #4 to 1/0 AWG (21.1 to 53.5mm²). Mechanical keys ensure connectors will only mate with connectors of the same color. Different color housings are selected to identify voltages, thus preventing mismatching of the power supply system.

FEATURES

- Mechanical keyed housings**
Prevents accidental mating of components operating at different voltage levels
- Flat wiping contact system**
Allows for minimal contact resistance at high current, wiping action cleans contact surface during disconnection
- Genderless design**
Makes assembly quick and easy and reduces number of parts stocked



PRODUCT SPECIFICATIONS

| Connector Model | SB [®] 175 | Connector Model | SB [®] 175 |
|--|---------------------|--|----------------------------------|
| UL Current Rating (Amperes)* | 175* | Life | |
| UL Voltage Ratings (Volts) | 600* | a. No load (Contact/Disconnect Cycles) | To 10,000 |
| Contact Barrel Wire Size (AWG) | #4 to 1/0 | b. Under Load (Hot Plug 250 cycles @ 120V) | 75A |
| (mm ²) | 21.1 to 53.5 | Avg. Connection/Disconnect (lbf) | 25 (SB 2 Pole) 35 (SB 3 Pole) |
| Maximum Wire Insulation Diameter (inches) | 0.75 | Operating Temperature Range °C** | -20° to 105° |
| (mm) | 19.01 | °F | -4° to 221° |
| AVG Contact Resistance* (micro-ohms) | 100 | Flammability Rating of Housing Material | UL94 V-0 |
| Insulation Withstanding Test Voltage (Volts AC/DC) | 2200 | | |
| Contact Retention Force (lbf) | 300 | <small>* UL Rated for 65°C largest wire or cable size ** Contact factory for higher temperature rated connector SB[®], UL and CSA Reference: This equipment is an Underwriters Laboratories Inc[®] recognized component. It is also listed by the Canadian Standards Association as certified.</small> | |

ORDERING INFORMATION

2 Pole Housing & 175 amp Contacts

| Part Number | Housing Color | Wire AWG | Wire sq. mm |
|-------------|---------------|----------|-------------|
| 6325G1 | Gray | 1/0 | 53.5 |
| 6326G1 | Blue | 1/0 | 53.5 |
| 6327G1 | Orange | 1/0 | 53.5 |
| 6328G1 | Yellow | 1/0 | 53.5 |
| 6329G1 | Red | 1/0 | 53.5 |
| 6325G5 | Gray | #2 | 33.6 |
| 6326G5 | Blue | #2 | 33.6 |
| 6327G5 | Orange | #2 | 33.6 |
| 6328G5 | Yellow | #2 | 33.6 |
| 6329G5 | Red | #2 | 33.6 |
| 6325G6 | Gray | #4 | 21.1 |
| 6326G6 | Blue | #4 | 21.1 |
| 6327G6 | Orange | #4 | 21.1 |
| 6328G6 | Yellow | #4 | 21.1 |
| 6329G6 | Red | #4 | 21.1 |

Housings Only

| Part Number | Description |
|-------------|-----------------------|
| 940 | Gray |
| 941 | Blue |
| 942 | Orange |
| 943 | Yellow |
| 949 | Red |
| 2-7252G11 | Black, no voltage key |

175 amp Contacts

| Part Number | Description | Wire AWG | Wire sq. mm |
|-------------|-----------------|----------|-------------|
| 944 | Contact set (2) | 1/0 | 53.5 |
| 1382 | Individual | 1/0 | 53.5 |
| 947 | Contact set (2) | #2 | 33.6 |
| 1383 | Individual | #2 | 33.6 |
| 948 | Contact set (2) | #4 | 21.1 |
| 1384 | Individual | #4 | 21.2 |
| 948G1* | Contact set (2) | #6 | 13.3 |
| 1348* | Individual | #6 | 13.3 |
| 944G1 | Contact set (2) | #1 | 42.4 |
| 1347 | Individual | #1 | 42.4 |
| 180BBS | Bus bar contact | N/A | N/A |

3 Pole Housing & 175 amp Contacts

| Part Number | Housing Color | Wire AWG | Wire sq. mm |
|-------------|---------------|----------|-------------|
| 6316 | Gray | 1/0 | 53.5 |
| 6316G9 | Gray | #1 | 42.4 |
| 6316G10 | Gray | #2 | 33.6 |

3 Pole Housing Only

| Part Number | Description |
|-------------|--------------------------|
| 902 | Gray, springs & hardware |

* Thin wall
Note: For additional colors please contact customer service

HEADQUARTERS: 13 Pratts Junction Road, P.O. Box 579, Sterling, MA 01564 T:978-422-3600 F:978-422-3700

EUROPE: Rathealy Road, Fermoy Co. Cork, Ireland T:353-(0)25-32277 F:353-(0)25-32296

ASIA/PACIFIC: IDEAL Anderson Asia Pacific Ltd., Unit 922-928 Topsail Plaza, 11 On Sum Street, Shatin N.T., Hong Kong T:852-2636-0836 F:852-2635-9036

CHINA: IDEAL Anderson Technologies (Shenzhen) Ltd., Block A8 Tantou W. Ind. Par. Songgang Baoan District, Shenzhen, P.R. China 51810 T: 86-755-2768-2118 F: 86-755-2768-2218

TAIWAN: IDEAL Anderson Asia Pacific Ltd., Taiwan Branch, 4F-2, No.116, Dadun 20th St., Situn District, Taichung City 407, Taiwan (R.O.C.) T: 886-4-2310-6451 F:886-4-2310-6460

www.andersonpower.com

ORDERING INFORMATION & DIMENSIONS

Accessories

| Part Number | Description |
|---------------|---|
| 995G1 | Handle, hardware & lock washers - Gray |
| 995G3 | Handle, hardware & lock washers - Red |
| 923 | Manual release, locking half with clamps and hardware |
| 924 | Manual release, mounting half with clamps and hardware |
| 110G56 | Lock nut for use with Bus bar contact |
| SB175-lockout | Safety lockout |
| 111197G1 | Charger key |
| 134G2 | Dust cover |
| 945 | Cable clamps |
| 945G3 | Cable clamps-2 single conductor with hardware. Use with "A" frame only. |
| 946G1 | Cable clamps-1 twin conductor with hardware. Use with "A" frame only. |

Bushings

| Part Number | Description | Wire | |
|-------------|--------------|------------|--------------|
| | | AWG | sq. mm |
| 5648 | Use with 944 | 1/0 to #10 | 53.5 to 5.1 |
| 5663 | Use with 944 | 1/0 to #6 | 53.5 to 13.3 |
| 5687 | Use with 944 | 1/0 to #1 | 53.5 to 42.4 |
| 5690 | Use with 944 | 1/0 to #2 | 53.5 to 33.6 |
| 5693 | Use with 944 | 1/0 to #4 | 53.5 to 21.2 |

Tooling

| Part Number | Description |
|-------------|-------------------------------------|
| 1368 | Hand tool for 1/0 to #1 (53.5/42.4) |
| 1387G1 | Pneumatic tool |
| 1388G3 | - die for 1/0 to #1 (53.5/42.4) |
| 1388G5 | - die for #4 |
| 1389G5 | - locator for #4 |
| 1389G3 | - locator for 1/0 to #1 (53.5/42.4) |
| 1303G4 | - die for 1/0 to #4 (53.5/21.1) |
| 1304G4 | - locator for 1/0 to #4 (53.5/21.1) |

Housing

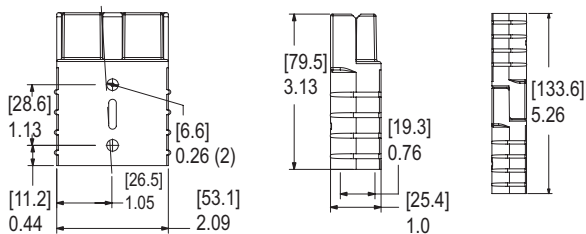

Bus Bar Mounting Table

| Part Number | - E - | | - F - | |
|-------------|-------|------|-------|------|
| | mm | in. | mm | in. |
| 180BBS | 88.9 | 3.50 | 10.2 | 0.40 |

| Part Number | - J - | |
|-------------|----------|-----------|
| | mm | in. |
| 180BBS | 5.0-19.0 | 0.20-0.75 |

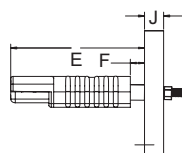

File No. LR25154 E26226

All Data Subject To Change Without Notice

TEMPERATURE RISE CHART

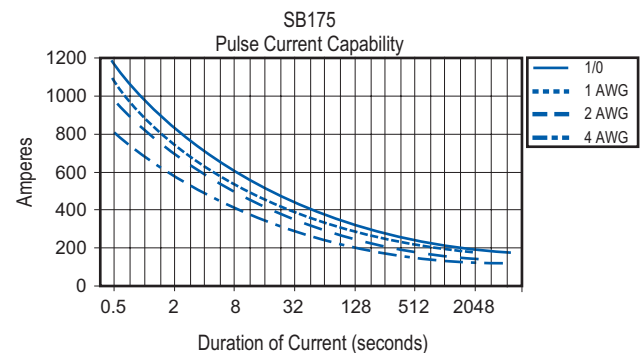
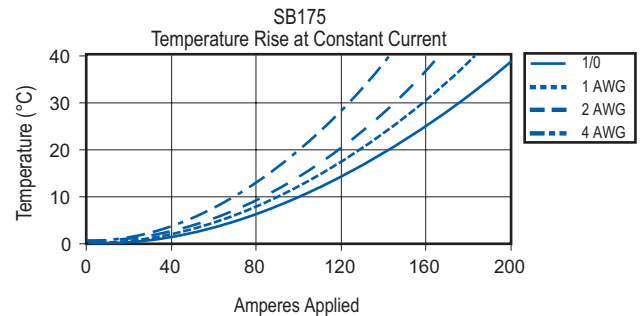

Contacts

| Part Number | -A- | | -B- | | -C- | | -D- | |
|-------------|-------|------|------|------|------|------|------|------------|
| | mm | in. | mm | in. | mm | in. | mm | in. |
| 944 | 59.7 | 2.35 | 13.1 | 0.52 | 11.1 | 0.44 | 27.4 | 1.08 |
| 947 | 59.7 | 2.35 | 13.1 | 0.52 | 8.9 | 0.35 | 27.4 | 1.08 |
| 948 | 59.7 | 2.35 | 13.1 | 0.52 | 7.5 | 0.30 | 25.9 | 1.02 |
| 944G1 | 59.7 | 2.35 | 13.1 | 0.52 | 9.9 | 0.39 | 27.4 | 1.08 |
| 948G1 | 53.3 | 2.10 | 9.3 | 0.37 | 11.7 | 0.46 | 21.3 | 0.84 |
| 180BBS | 109.0 | 4.29 | 25.4 | 1.00 | 12.7 | 0.50 | N/A | 1/4-20Thd. |

| Part Number | -E- | | -F- | |
|-------------|------|-----|-----|------|
| | mm | in. | mm | in. |
| 944 | 12.7 | 0.5 | N/A | |
| 947 | 12.7 | 0.5 | N/A | |
| 948 | 12.7 | 0.5 | N/A | |
| 944G1 | 12.7 | 0.5 | N/A | |
| 948G1 | 12.7 | 0.5 | N/A | |
| 180BBS | N/A | | 4.6 | 0.18 |

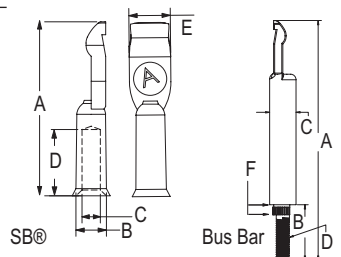

Bus Bar Layout

| Part Number | - J - | | - K - | | - L - | | - M - | |
|-------------|-------|------|-----------|-----------|-------|-------|-------|-------|
| | mm | in. | mm | in. | mm | in. | mm | in. |
| 180BBS | 26.8 | 1.05 | 26.8(min) | 1.05(min) | 9.53 | 0.375 | 3.43 | 0.135 |

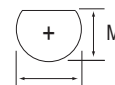
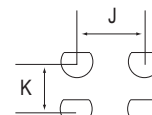

Mounting Dimensions

HEADQUARTERS: 13 Pratts Junction Road, P.O. Box 579, Sterling, MA 01564 T:978-422-3600 F:978-422-3700

EUROPE: Rathealy Road, Fermoy Co. Cork, Ireland T:353-(0)25-32277 F:353-(0)25-32296

ASIA/PACIFIC: IDEAL Anderson Asia Pacific Ltd., Unit 922-928 Topsail Plaza, 11 On Sum Street, Shatin N.T., Hong Kong T:852-2636-0836 F:852-2635-9036

CHINA: IDEAL Anderson Technologies (Shenzhen) Ltd., Block A8 Tantou W. Ind. Par, Songgang Baoan District, Shenzhen, PR. China 51810 T: 86-755-2768-2118 F: 86-755-2768-2218

TAIWAN: IDEAL Anderson Asia Pacific Ltd., Taiwan Branch, 4F.-2, No.116, Dadun 20th St., Situn District, Taichung City 407, Taiwan (R.O.C.) T: 886-4-2310-6451 F:886-4-2310-6460

www.andersonpower.com

The innovative SB[®] connectors provide cost-effective reliability, design flexibility and safety for your products' manufacture, installation and maintenance.

APP's 2 pole connector is available with a 350 amp rating, 600 Volts continuous AC or DC operation. There are SB[®] connectors for many applications and wire sizes, 2/0 AWG to 300 mcm (67.4 to 152.0 mm²). Mechanical keys ensure connectors will only mate with connectors of the same color. Different color housings are selected to identify voltages, thus preventing mismatching of the power supply system.

FEATURES

- Mechanical keyed housings**
Prevents accidental mating of components operating at different voltage levels
- Single-piece housing and unitized construction**
Provides industrial quality and durability
- Genderless design**
Makes assembly quick and easy and reduces number of parts stocked



PRODUCT SPECIFICATIONS

| Connector Model | SB [®] 350 | Connector Model | SB [®] 350 |
|---|---------------------------------|--|-----------------------------|
| UL Current Rating (Amperes)* | 350* | Life | |
| UL Voltage Ratings (Volts) | 600* | a. No load (Contact/Disconnect Cycles) | To 10,000 |
| Contact Barrel Wire Size (AWG) (mm ²) | 2/0 to 300 mcm 67.4 to 152.0 | b. Under Load (Hot Plug 250 cycles @ 120V) | 100A |
| Maximum Wire Insulation Diameter (inches) (mm) | 1.10 27.9 | Avg. Connection/Disconnect (lbf) | 30 |
| AVG Contact Resistance* (micro-ohms) | 50 | Operating Temperature Range °C** °F | -20° to 105° -4° to 221° |
| Insulation Withstanding Test Voltage (Volts AC/DC) | 2200 | Flammability Rating of Housing Material | UL94 V-0 |
| Contact Retention Force (lbf) | 500 | | |



* UL Rated for 65°C largest wire or cable size
 ** Contact factory for higher temperature rated connector
 SB[®], UL and CSA Reference: This equipment is an Underwriters Laboratories Inc[®] recognized component.
 It is also listed by the Canadian Standards Association as certified.

ORDERING INFORMATION

2 Pole Housing & 350 amp Contacts

| Part Number | Housing Color | Wire | |
|-------------|---------------|---------|--------|
| | | AWG | sq. mm |
| 6320G1 | Gray | 2/0 | 67.4 |
| 6320G2 | Gray | 4/0 | 107.2 |
| 6320G4 | Gray | 300 mcm | 152.0 |
| 6320G5 | Gray | 3/0 | 85.0 |
| 6321G1 | Blue | 2/0 | 67.4 |
| 6321G2 | Blue | 4/0 | 107.2 |
| 6321G4 | Blue | 300 mcm | 152.0 |
| 6321G5 | Blue | 3/0 | 85.0 |
| 6322G1 | Red | 2/0 | 67.4 |
| 6322G2 | Red | 4/0 | 107.2 |
| 6322G4 | Red | 300 mcm | 152.0 |
| 6322G5 | Red | 3/0 | 85.0 |
| 6323G1 | Yellow | 2/0 | 67.4 |
| 6323G2 | Yellow | 4/0 | 107.2 |
| 6323G4 | Yellow | 300 mcm | 152.0 |
| 6323G5 | Yellow | 3/0 | 85.0 |

2 Pole Housing & 350 amp Contacts continued

| Part Number | Description | Wire | |
|-------------|-------------|---------|--------|
| | | AWG | sq. mm |
| 6324G1 | Green | 2/0 | 67.4 |
| 6324G2 | Green | 4/0 | 107.2 |
| 6324G4 | Green | 300 mcm | 152.0 |
| 6324G5 | Green | 3/0 | 85.0 |
| 6400G1 | Orange | 2/0 | 67.4 |
| 6400G2 | Orange | 4/0 | 107.2 |
| 6400G4 | Orange | 300 mcm | 152.0 |
| 6400G5 | Orange | 3/0 | 85.0 |

Housings Only

| Part Number | Color |
|-------------|-------|
| 906 | Gray |
| 912 | Blue |
| 913 | Red |

housings continued

| Part Number | Color |
|-------------|--------|
| 914 | Yellow |
| 931 | Green |
| 932 | Orange |

Contacts

| Part Number | Description | Wire | |
|-------------|-----------------|---------|--------|
| | | AWG | sq. mm |
| 917 | Contact set (2) | 1/0 | 53.5 |
| 907 | Contact set (2) | 2/0 | 67.4 |
| 916 | Contact set (2) | 3/0 | 85.0 |
| 908 | Contact set (2) | 4/0 | 107.2 |
| 910 | Contact set (2) | 300 mcm | 152.0 |
| 350BBS | Bus bar contact | N/A | N/A |

Note: For additional colors please contact customer service

HEADQUARTERS: 13 Pratts Junction Road, P.O. Box 579, Sterling, MA 01564 T:978-422-3600 F:978-422-3700

EUROPE: Rathealy Road, Fermoy Co. Cork, Ireland T:353-(0)25-32277 F:353-(0)25-32296

ASIA/PACIFIC: IDEAL Anderson Asia Pacific Ltd., Unit 922-928 Topsail Plaza, 11 On Sum Street, Shatin N.T., Hong Kong T:852-2636-0836 F:852-2635-9036

CHINA: IDEAL Anderson Technologies (Shenzhen) Ltd., Block A8 Tantou W. Ind. Par, Songgang Baoan District, Shenzhen, PR. China 51810 T: 86-755-2768-2118 F: 86-755-2768-2218

TAIWAN: IDEAL Anderson Asia Pacific Ltd., Taiwan Branch, 4F-2, No.116, Dadun 20th St., Situn District, Taichung City 407, Taiwan (R.O.C.) T: 886-4-2310-6451 F:886-4-2310-6460

www.andersonpower.com

ORDERING INFORMATION

Accessories

| Part Number | Description |
|---------------|--|
| 995G2 | Handle & hardware-gray |
| 995G4 | Handle & hardware-red |
| 919 | Manual release-locking half-cable clamps, hardware & lock out spring for the battery |
| 919G1 | Mounting half-mounting half-hardware & lock out spring for battery |
| 922G1 | Mounting half-hardware for truck or charger |
| 111197G1 | Charger key |
| 134G3 | Dust cover |
| 996G1 | Cable clamps-2 single conductor with hardware |
| 911 | Cable clamps-2 single conductor, cables with hardware and steel handle |
| SB350-lockout | Safety lockout |

Bushings

| Part Number | Description | Wire | |
|-------------|--------------|------------|--------------|
| | | AWG | sq. mm |
| 5918 | Use with 907 | 2/0 to 1/0 | 67.4 to 53.5 |

Tooling

| Part Number | Description |
|-------------|------------------------------|
| 1368 | Hand tool for 1/0 to 300 mcm |
| 1387G1 | Pneumatic tool |
| 1387G2 | Pneumatic tool |
| 1388G2 | - die for 2/0 to 3/0 |
| 1389G2 | - locator for 2/0 to 3/0 |
| 1388G1 | - die for 4/0 |
| 1389G1 | - locator for 4/0 |
| 1304G9 | - loctor for 4/0 |
| 1303G3 | - die for 4/0 |

Housing

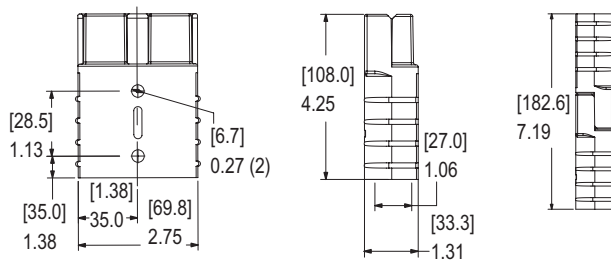

Bus Bar Layout

| Part Number | - J - | - K - | - L - | - M - |
|-------------|-----------|---------------------|-------------|-------------|
| | mm in. | mm in. | mm in. | mm in. |
| 350BBS | 34.9 1.38 | 33.8(min) 1.33(min) | 13.34 0.525 | 11.76 0.463 |

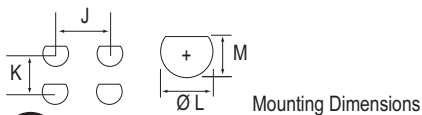

File No. E26226 All Data Subject To Change Without Notice

TEMPERATURE RISE CHART

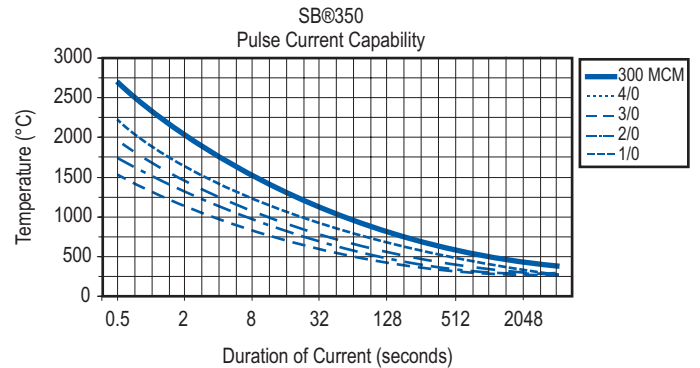
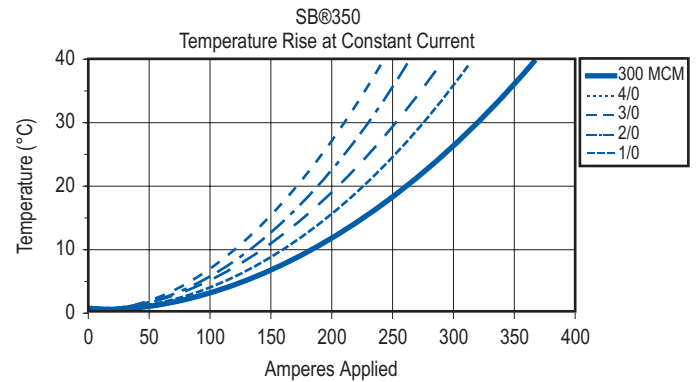

DIMENSIONS

SB® Contacts

| Part Number | -A- | | -B- | | -C- | | -D- | | -E- | |
|-------------|-------|------|------|------|------|------|------|-------------|------|------|
| | mm | in. | mm | in. | mm | in. | mm | in. | mm | in. |
| 907 | 75.1 | 2.96 | 16.3 | 0.64 | 12.4 | 0.49 | 32.8 | 1.29 | 20.6 | 0.81 |
| 908 | 75.1 | 2.96 | 19.1 | 0.75 | 16.3 | 0.64 | 32.8 | 1.29 | 20.6 | 0.81 |
| 910 | 73.9 | 2.91 | 22.2 | 0.87 | 19.1 | 0.75 | 32.5 | 1.28 | 20.6 | 0.81 |
| 916 | 75.1 | 2.96 | 17.9 | 0.7 | 14.7 | 0.58 | 32.8 | 1.29 | 20.6 | 0.81 |
| 917 | 73.9 | 2.91 | 13 | 0.51 | 11.1 | 0.44 | 31.8 | 1.25 | 20.6 | 0.81 |
| 350BBS | 131.7 | 5.19 | 22.3 | 0.88 | 17.0 | 0.67 | N/A | #3/8-19Thd. | 2.5 | 0.10 |

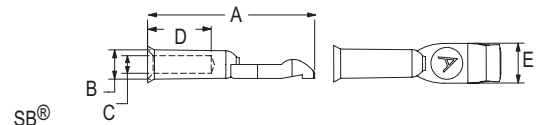

Bus Bar

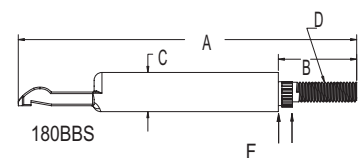

Bus Bar Mounting Table

| Part Number | - E - | - F - | - J - |
|-------------|------------|----------|--------------------|
| | mm in. | mm in. | mm in. |
| 350BBS | 113.0 4.45 | 5.1 0.20 | 3.0-19.6 0.12-0.77 |

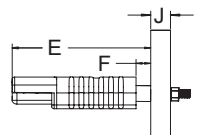

HEADQUARTERS: 13 Pratts Junction Road, P.O. Box 579, Sterling, MA 01564 T:978-422-3600 F:978-422-3700

EUROPE: Rathealy Road, Fermoy Co. Cork, Ireland T:353-(0)25-32277 F:353-(0)25-32296

ASIA/PACIFIC: IDEAL Anderson Asia Pacific Ltd., Unit 922-928 Topsail Plaza, 11 On Sum Street, Shatin N.T., Hong Kong T:852-2636-0836 F:852-2635-9036

CHINA: IDEAL Anderson Technologies (Shenzhen) Ltd., Block A8 Tantou W. Ind. Par, Songgang Baoan District, Shenzhen, PR. China 51810 T: 86-755-2768-2118 F: 86-755-2768-2218

TAIWAN: IDEAL Anderson Asia Pacific Ltd., Taiwan Branch, 4F.-2, No.116, Dadun 20th St., Situn District, Taichung City 407, Taiwan (R.O.C.) T: 886-4-2310-6451 F:886-4-2310-6460



Connector Notes

For customer drawings, assembly instructions and individual data sheets, please visit www.andersonpower.com.

HEADQUARTERS: 13 Pratts Junction Road, P.O. Box 579, Sterling, MA 01564 T:978-422-3600 F:978-422-3700

EUROPE: Rathealy Road, Fermoy Co. Cork, Ireland T:353-(0)25-32277 F:353-(0)25-32296

ASIA/PACIFIC: IDEAL Anderson Asia Pacific Ltd., Unit 922-928 Topsail Plaza, 11 On Sum Street, Shatin N.T., Hong Kong T:852-2636-0836 F:852-2635-9036

CHINA: IDEAL Anderson Technologies (Shenzhen) Ltd., Block A8 Tantou W. Ind. Par, Songgang Baoan District, Shenzhen, P.R. China 51810 T: 86-755-2768-2118 F: 86-755-2768-2218

TAIWAN: IDEAL Anderson Asia Pacific Ltd., Taiwan Branch, 4F.-2, No.116, Dadun 20th St., Situn District, Taichung City 407, Taiwan (R.O.C.) T: 886-4-2310-6451 F:886-4-2310-6460

www.andersonpower.com

FEATURES

- Finger proof**
Helps prevent fingers (or probes) from accidentally touching live contacts. SBE®160 and SBE®320 connector meets EN1175 requirements
- Mechanical keyed housings**
Prevents accidental mating of components operating at different voltage levels
- Auxiliary contacts**
Provides ability to incorporate a secondary sensor control circuit
- Single-piece housing and unitized construction**
Provides industrial quality and durability
- Optional air supply system**
Supplies air to battery during charging
- Genderless design**
Makes assembly quick and easy and reduces number of parts stocked
- UL94 V-0 housing material**
Provides security in knowledge that the connector chosen meets strict UL flammability ratings



PRODUCT RANGE

| | |
|--|----------------|
| UL Current Rating (Amperes)* | 80 to 700* |
| UL Voltage Ratings (Volts) | 150* |
| Contact Barrel Wire Size (AWG) | #6 to 300 mcm |
| (mm ²) | 13.3 to 152.0 |
| Maximum Wire Insulation Diameter (inches) | 0.44 to 1.10 |
| (mm) | 11.18 to 27.94 |
| AVG Contact Resistance* (micro-ohms) | 200 to 50 |
| Insulation Withstanding | 2200 |
| Test Voltage (Volts AC/DC) | |
| Contact Retention Force (lbf) | 50 to 500 |
| Life | |
| a. No load (Contact/Disconnect Cycles) | To 10,000 |
| b. Under Load (Hot Plug 250 cycles @ 120V) | 60 to 100A* |
| Avg. Connection/Disconnect (lbf) | 15 to 30 |
| Operating Temperature Range °C** | -20° to 105° |
| °F | -4° to 221° |
| Flammability Rating of Housing Material | UL94 V-0 |

Recommended Voltage Key Color Code

| | | | | | | | | | | |
|---------|--------|--------|-----|------|------|-------|-------|-------|--------|-------|
| Voltage | 12V | 18V | 24V | 36V | 48V | 72V | 80V | 96V | 120V | 144V |
| Color | Yellow | Orange | Red | Gray | Blue | Green | Black | Brown | Purple | White |



* UL Rated for 65°C largest wire or cable size

** Contact factory for higher temperature rated connectors

PRODUCT INFORMATION

Invented by Anderson Power Products®, the innovative SBE® connectors provide cost-effective reliability, design flexibility and safety for your products' manufacture, installation and maintenance. APP's 2 pole connectors are available for 80, 160, 320 and 700 amp ratings for use to 150 Volts continuous AC or DC operation. There are SBE® connectors for many applications and wire sizes, #6 (13.3mm²) to 300 mcm (152.0mm²). Mechanical keys ensure connectors will only mate with connectors of the same color. Different color housings are selected to identify voltages, thus preventing mismatching of the power supply system.

The housings are interchangeable, genderless interconnects. Insert contacts into housings and plug together for a clever, simple and low-cost solution to power interconnection.

Markets: UPS Systems, Telecommunications, Forklift Trucks, Wheelchairs, EV, Chargers, Power Electronics & Much More.



SBE160 and SBE320



CSA Certified
File No. LR25154



File No. E26226

All Data Subject To Change Without Notice

HEADQUARTERS: 13 Pratts Junction Road, P.O. Box 579, Sterling, MA 01564 T:978-422-3600 F:978-422-3700

EUROPE: Rathealy Road, Fermoy Co. Cork, Ireland T:353-(0)25-32277 F:353-(0)25-32296

ASIA/PACIFIC: IDEAL Anderson Asia Pacific Ltd., Unit 922-928 Topsail Plaza, 11 On Sum Street, Shatin N.T., Hong Kong T:852-2636-0836 F:852-2635-9036

CHINA: IDEAL Anderson Technologies (Shenzhen) Ltd., Block A8 Tantou W. Ind. Par, Songgang Baoan District, Shenzhen, P.R. China 51810 T: 86-755-2768-2118 F: 86-755-2768-2218

TAIWAN: IDEAL Anderson Asia Pacific Ltd., Taiwan Branch, 4F.-2, No.116, Dadun 20th St., Situn District, Taichung City 407, Taiwan (R.O.C.) T: 886-4-2310-6451 F:886-4-2310-6460

www.andersonpower.com

This connector is for hot-plug use at 60 amps. It contains recessed contacts and a ribbed nose housing, thus providing finger proofing in environments where human contact is a consideration. Available in different colors, this genderless connector is mechanically keyed to ensure connectors will only mate with connectors of the same color.

With the silver-plated copper contacts, there is a maximum connect/disconnect life of 10,000 cycles, with 150 volts continuous AC or DC operation. Accessories, such as integral cable clamp and handle, provide strain relief and ease of use.

FEATURES

- **Meets UL 1950 finger probe test**

Each half offers finger proofing and can be connected to two energized sources up to 150 volts AC/DC

- **Auxiliary contacts**

Provides additional poles up to 30 amps for auxiliary power, control or sensing

- **Handle**

Eases connector use and relieves unnecessary strain on cables when disconnecting

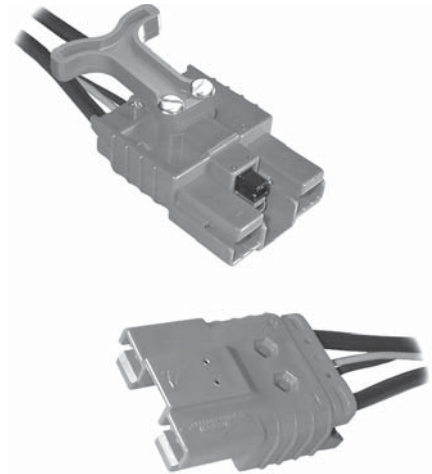

PRODUCT SPECIFICATIONS

| Connector Model | SBE®80 | Connector Model | SBE®80 |
|---|------------------------------|---|--------------|
| Current rating (main contacts) | 80 | Insulation with standing test voltage (volts AC/DC) | 1300 |
| Largest wire size (AWG) (mm ²) | #6 (60 amps) 16 (80 amps) | Maximum wire insulation diameter (inches) (mm) | 0.44 11.2 |
| Maximum operating voltage AC/DC | 150 | Contact retention force (lbf) | 50 |
| Contact material | Silver plated copper | Life: | |
| Operating temperature range °C °F | -20° to 105° -4° to 221° | a. No load (connect/disconnect cycles) | To 10,000 |
| Flammability rating of housing material | UL94 V-0 | b. Under load (hot plug 250 cycles @ 120V) | 60A |
| AVG contact resistance* (microhoms) | 200 | | |



*UL rated for 65 °C largest wire or cable size

ORDERING INFORMATION

Housing Only

| Part Number | Housing Color |
|-------------|---------------|
| SBE80RED | Red |
| SBE80YEL | Yellow |
| SBE80ORN | Orange |
| SBE80WHT | White |

Contacts

| Part Number | Description | Wire AWG | Wire sq. mm |
|-------------|-----------------|----------|-------------|
| 1339G1 | Contact set (2) | #6 | 16 |

Bushings

| Part Number | Description | Wire AWG | Wire sq. mm |
|-------------|-----------------|--------------|---------------|
| 5912 | Use with 1339G1 | #6 to #8 | 16 to 8.4 |
| 5910 | Use with 1339G1 | #6 to #10/12 | 16 to 5.3/3.3 |

Cable Clamp & Hardware

| Part Number | Housing Color |
|-------------|---------------|
| SBE80CLPRED | Red |

Handle/Hardware & Accessories

| Part Number | Description |
|-------------|-----------------------|
| SBE80HDLRED | Red housing |
| 6344 | Auxiliary contact kit |

Housing, Contacts, Handle, Clamp & Hardware

| Part Number | Housing Color |
|-----------------|---------------|
| SBE80RED16MMHDL | Red |

Tooling

| Part Number | Description |
|-------------|----------------------------|
| 1309G4 | Hand tool |
| 1387G1 | Pneumatic tool |
| 1388G6 | - die for #6 AWG/16 mm |
| 1389G9 | - locator for #6 AWG/16 mm |

Note: For additional colors please contact customer service

HEADQUARTERS: 13 Pratts Junction Road, P.O. Box 579, Sterling, MA 01564 T:978-422-3600 F:978-422-3700

EUROPE: Rathealy Road, Fermoy Co. Cork, Ireland T:353-(0)25-32277 F:353-(0)25-32296

ASIA/PACIFIC: IDEAL Anderson Asia Pacific Ltd., Unit 922-928 Topsail Plaza, 11 On Sum Street, Shatin N.T., Hong Kong T:852-2636-0836 F:852-2635-9036

CHINA: IDEAL Anderson Technologies (Shenzhen) Ltd., Block A8 Tantou W. Ind. Par. Songgang Baoan District, Shenzhen, P.R. China 51810 T: 86-755-2768-2118 F: 86-755-2768-2218

TAIWAN: IDEAL Anderson Asia Pacific Ltd., Taiwan Branch, 4F.-2, No.116, Dadun 20th St., Situn District, Taichung City 407, Taiwan (R.O.C.) T: 886-4-2310-6451 F:886-4-2310-6460

www.andersonpower.com

DIMENSIONS

Housing

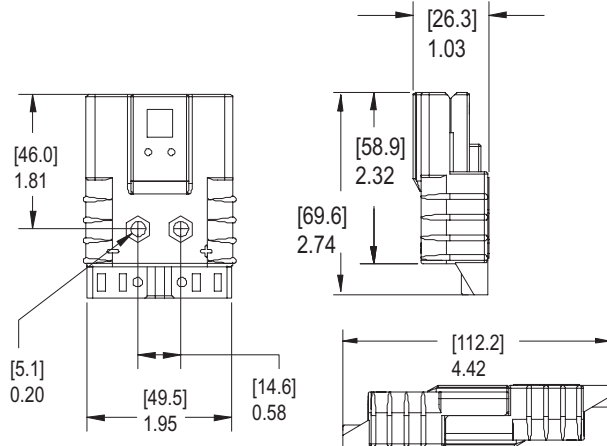

TEMPERATURE RISE CHART

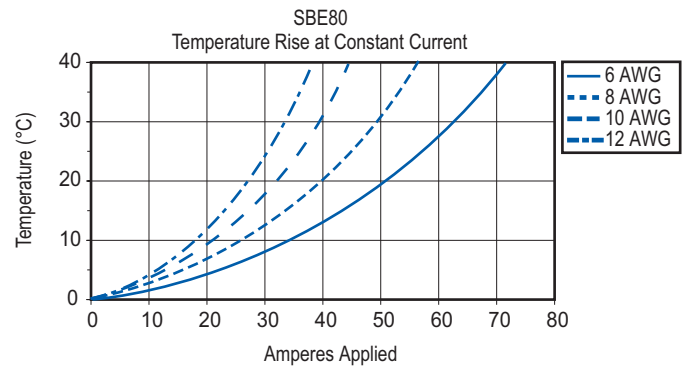

Contacts

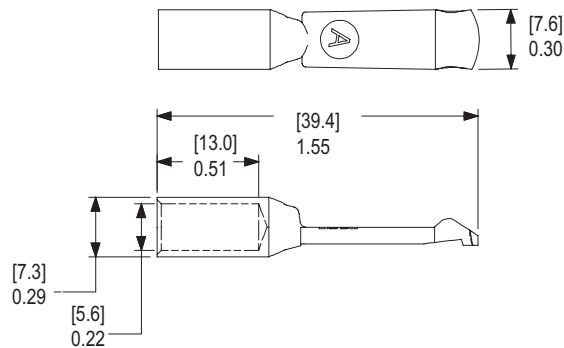

All Data Subject To Change Without Notice

HEADQUARTERS: 13 Pratts Junction Road, P.O. Box 579, Sterling, MA 01564 T:978-422-3600 F:978-422-3700

EUROPE: Rathealy Road, Fermoy Co. Cork, Ireland T:353-(0)25-32277 F:353-(0)25-32296

ASIA/PACIFIC: IDEAL Anderson Asia Pacific Ltd., Unit 922-928 Topsail Plaza, 11 On Sum Street, Shatin N.T., Hong Kong T:852-2636-0836 F:852-2635-9036

CHINA: IDEAL Anderson Technologies (Shenzhen) Ltd., Block A8 Tantou W. Ind. Par, Songgang Baoan District, Shenzhen, P.R. China 51810 T: 86-755-2768-2118 F: 86-755-2768-2218

TAIWAN: IDEAL Anderson Asia Pacific Ltd., Taiwan Branch, 4F.-2, No.116, Dadun 20th St., Situn District, Taichung City 407, Taiwan (R.O.C.) T: 886-4-2310-6451 F:886-4-2310-6460

www.andersonpower.com

The innovative SBE® connectors provide cost-effective reliability, design flexibility and safety for your products' manufacture, installation and maintenance.

APP's 2 pole connector is available with a 160 amp rating, 150 Volts continuous AC or DC operation. There are SBE® connectors for many applications and wire sizes, 1/0 or 35 mm. Mechanical keys ensure connectors will only mate with connectors of the same color. Different color housings are selected to identify voltages, thus preventing mismatching of the power supply system.

FEATURES

- Finger proofing**
Helps prevent fingers (or probes) from accidentally touching live contacts. SBE®160 connector meets EN1175 requirements.
- Auxiliary contacts**
Provides ability to incorporate a secondary sensor control circuit
- Optional air supply system**
Supplies air to battery during charging



PRODUCT SPECIFICATIONS

| Connector Model | SBE®160 | Connector Model | SBE®160 |
|--|--------------|--|--------------|
| UL Current Rating (Amperes)* | 160* | Life | |
| UL Voltage Ratings (Volts) | 150* | a. No load (Contact/Disconnect Cycles) | To 10,000 |
| Contact Barrel Wire Size (AWG) | 1/0 or 35 mm | b. Under Load (Hot Plug 250 cycles @ 120V) | 75A |
| Maximum Wire Insulation Diameter (inches) | 0.75 | Avg. Connection/Disconnect (lbf) | 25 |
| (mm) | 19.1 | Operating Temperature Range °C** | -20° to 105° |
| AVG Contact Resistance* (micro-ohms) | 100 | °F | -4° to 221° |
| Insulation Withstanding Test Voltage (Volts AC/DC) | 1300 | Flammability Rating of Housing Material | UL94 V-0 |
| Contact Retention Force (lbf) | 300 | | |



* UL Rated for 65°C largest wire or cable size
 ** Contact factory for higher temperature rated connector

ORDERING INFORMATION

2 Pole Housing, 160 amp Contacts, & Auxiliary Contacts

| Part Number | Housing Color | Wire sq. mm |
|-------------|---------------|-------------|
| E6370G2 | Gray | 35 |
| E6371G2 | Blue | 35 |
| E6372G2 | Orange | 35 |
| E6373G2 | Yellow | 35 |
| E6378G2 | Red | 35 |
| E6387G2 | Green | 35 |
| E6388G2 | Black | 35 |

2 Pole Housing & Contacts

| Part Number | Housing Color | Wire sq. mm |
|-------------|---------------|-------------|
| E6374G2 | Gray | 35 |
| E6375G2 | Blue | 35 |
| E6376G2 | Orange | 35 |
| E6377G2 | Yellow | 35 |

2 pole housing & contacts continued

| Part Number | Housing Color | Wire sq. mm |
|-------------|---------------|-------------|
| E6379G2 | Red | 35 |
| E6391G2 | Green | 35 |
| E6389G2 | Black | 35 |

Housings Only

| Part Number | Color |
|-------------|--------|
| E6380G1 | Gray |
| E6381G1 | Blue |
| E6382G1 | Orange |
| E6383G1 | Yellow |
| E6385G1 | Red |
| E6390G1 | Green |
| E6392G1 | Black |

Contacts

| Part Number | Description | AWG | Wire sq. mm |
|-------------|-----------------|-----|-------------|
| 6384G2 | Contact set (2) | N/A | 35 |
| 6384G1 | Contact set (2) | 1/0 | 53.5 |

Accessories

| Part Number | Description |
|-------------|--|
| 6344 | Auxiliary contact kit |
| 6337G1 | Charger key |
| 995G1 | Handle with hardware"A" frame |
| 993G2 | Manual release-battery bracket with hardware |
| 994G2 | Manual release-charger/truck bracket with hardware |
| 945G2 | Cable clamps-use alone with manual release or "A" frame handle |

| Part Number | Description |
|-------------|--|
| 6367G1 | #16/12(1.31/3.31mm)-for battery-pin |
| 6366G2 | #16/12(1.31/3.31mm)-for charger & truck-tube |

Note: For additional colors please contact customer service

HEADQUARTERS: 13 Pratts Junction Road, P.O. Box 579, Sterling, MA 01564 T:978-422-3600 F:978-422-3700

EUROPE: Rathealy Road, Fermoy Co. Cork, Ireland T:353-(0)25-32277 F:353-(0)25-32296

ASIA/PACIFIC: IDEAL Anderson Asia Pacific Ltd., Unit 922-928 Topsail Plaza, 11 On Sum Street, Shatin N.T., Hong Kong T:852-2636-0836 F:852-2635-9036

CHINA: IDEAL Anderson Technologies (Shenzhen) Ltd., Block A8 Tantou W. Ind. Par, Songgang Baoan District, Shenzhen, PR. China 51810 T: 86-755-2768-2118 F: 86-755-2768-2218

TAIWAN: IDEAL Anderson Asia Pacific Ltd., Taiwan Branch, 4F-2, No.116, Dadun 20th St., Situn District, Taichung City 407, Taiwan (R.O.C.) T: 886-4-2310-6451 F:886-4-2310-6460

ORDERING INFORMATION

accessories continued

Bushings

| Part Number | Description | Wire | |
|-------------|---------------------|------------|--------------|
| | | AWG | sq. mm |
| 5687 | For use with 6384G1 | 1/0 to #1 | 53.5 to 42.4 |
| 5690 | For use with 6384G1 | 1/0 to #2 | 53.5 to 33.6 |
| 5693 | For use with 6384G1 | 1/0 to #4 | 53.5 to 21.2 |
| 5663 | For use with 6384G1 | 1/0 to #6 | 53.5 to 13.3 |
| 5648 | For use with 6384G1 | 1/0 to #10 | 53.5 to 5.3 |
| 5920 | For use with 6384G2 | N/A | 35mm to 16mm |

Tooling

| Part Number | Description |
|-------------|---|
| 969P1 | Extraction tool-insulatd handle |
| 111038G2 | Contact insertion/extraction tool for auxiliary contact kit |
| 1368 | Hand tool for 1/0 to 35mm (53.5/35) |
| 1387G1 | Pneumatic tool |
| 1388G3 | - die for 1/0 to #10 (53.5/5.26) |
| 1389G3 | - locator for 1/0 to #10 (53.5/5.26) |
| 1387G2 | - Pneumatic tool |
| 1303G4 | - die for #4 (21.1) |
| 1304G4 | - locator for #4 (21.1) |

DIMENSIONS

Housing

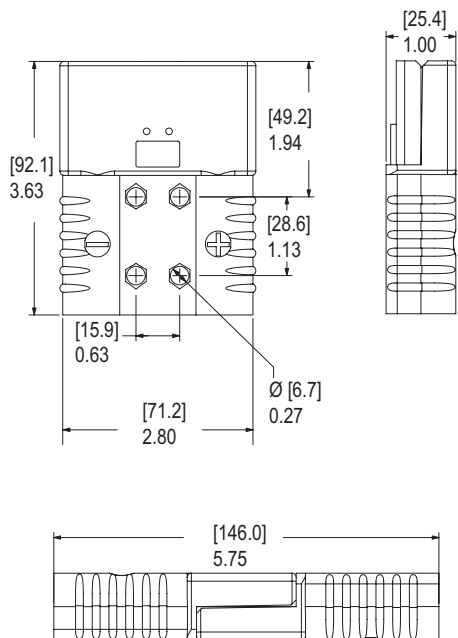

TEMPERATURE RISE CHART

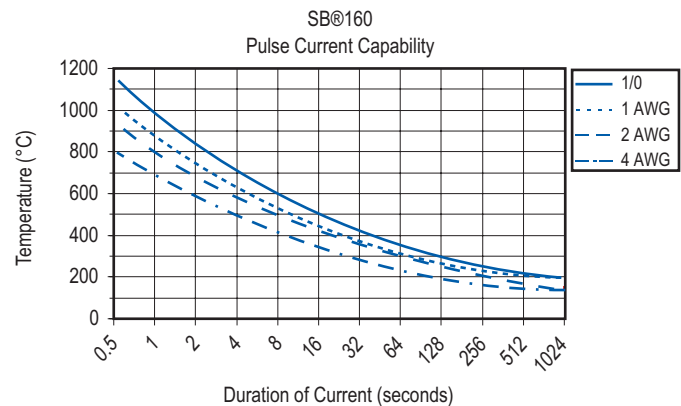
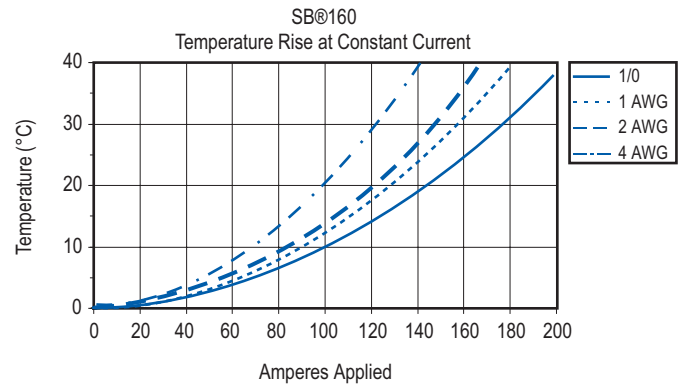

Contacts

| | -A- | | -B- | | -C- | | -D- | | -E- | |
|--------|------|------|------|------|------|------|------|------|------|------|
| | mm | in. | mm | in. | mm | in. | mm | in. | mm | in. |
| 6384G1 | 59.2 | 2.33 | 13.1 | 0.52 | 11.1 | 0.44 | 20.7 | 0.82 | 12.7 | 0.50 |
| 6384G2 | 59.2 | 2.33 | 13.1 | 0.52 | 9.5 | 0.38 | 20.7 | 0.82 | 12.7 | 0.50 |

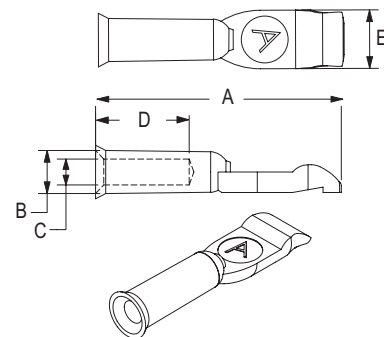

File No. E26226

All Data Subject To Change Without Notice

HEADQUARTERS: 13 Pratts Junction Road, P.O. Box 579, Sterling, MA 01564 T:978-422-3600 F:978-422-3700

EUROPE: Rathealy Road, Fermoy Co. Cork, Ireland T:353-(0)25-32277 F:353-(0)25-32296

ASIA/PACIFIC: IDEAL Anderson Asia Pacific Ltd., Unit 922-928 Topsail Plaza, 11 On Sum Street, Shatin N.T., Hong Kong T:852-2636-0836 F:852-2635-9036

CHINA: IDEAL Anderson Technologies (Shenzhen) Ltd., Block A8 Tantou W. Ind. Par, Songgang Baoan District, Shenzhen, P.R. China 51810 T: 86-755-2768-2118 F: 86-755-2768-2218

TAIWAN: IDEAL Anderson Asia Pacific Ltd., Taiwan Branch, 4F.-2, No.116, Dadun 20th St., Situn District, Taichung City 407, Taiwan (R.O.C.) T: 886-4-2310-6451 F:886-4-2310-6460

www.andersonpower.com

The innovative SBE® connectors provide cost-effective reliability, design flexibility and safety for your products' manufacture, installation and maintenance.

APP's 2 pole connector is available with a 320 amp rating, 150 Volts continuous AC or DC operation. There are SBE® connectors for many applications and wire sizes, 2/0 to 300 mcm (67.4 to 152.0 mm²). Mechanical keys ensure connectors will only mate with connectors of the same color. Different color housings are selected to identify voltages, thus preventing mismatching of the power supply system.

FEATURES

- **Genderless design**
Makes assembly quick and easy and reduces number of parts stocked
- **Auxiliary contacts**
Provides ability to incorporate a secondary circuit
- **Air supply system**
Supplies air to battery during charging



PRODUCT SPECIFICATIONS

| Connector Model | SBE®320 | Connector Model | SBE®320 |
|---|-------------------------------|--|-----------------------------|
| UL Current Rating (Amperes)* | 320* | Life | |
| UL Voltage Ratings (Volts) | 150* | a. No load (Contact/Disconnect Cycles) | To 10,000 |
| Contact Barrel Wire Size (AWG) (mm ²) | 2/0 to 300 mcm 67.4 to 152 | b. Under Load (Hot Plug 250 cycles @ 120V) | 100A* |
| Maximum Wire Insulation Diameter (inches) (mm) | 1.10 27.9 | Avg. Connection/Disconnect (lbf) | 30 |
| AVG Contact Resistance* (micro-ohms) | 50 | Operating Temperature Range °C** °F | -20° to 105° -4° to 221° |
| Insulation Withstanding Test Voltage (Volts AC/DC) | 1300 | Flammability Rating of Housing Material | UL94 V-0 |
| Contact Retention Force (lbf) | 500 | | |



* UL Rated for 65°C largest wire or cable size
** Contact factory for higher temperature rated connector

ORDERING INFORMATION

2 Pole Housing & 320 amp Contacts

| Part Number | Housing Color | Wire | |
|-------------|---------------|------|--------|
| | | AWG | sq. mm |
| E6334G1 | Brown | 2/0 | 67.4 |
| E6334G2 | Brown | 3/0 | 85.0 |
| E6334G6 | Brown | #2 | 33.6 |
| E6335G1 | Purple | 2/0 | 67.4 |
| E6335G2 | Purple | 3/0 | 85.0 |
| E6335G6 | Purple | #2 | 33.6 |
| E6345G1 | Gray | 2/0 | 67.4 |
| E6345G2 | Gray | 3/0 | 85.0 |
| E6345G6 | Gray | #2 | 33.6 |
| E6346G1 | Blue | 2/0 | 67.4 |
| E6346G2 | Blue | 3/0 | 85.0 |
| E6346G6 | Blue | #2 | 33.6 |
| E6347G1 | Red | 2/0 | 67.4 |
| E6347G2 | Red | 3/0 | 85.0 |
| E6347G6 | Red | #2 | 33.6 |
| E6348G1 | Green | 2/0 | 67.4 |
| E6348G2 | Green | 3/0 | 85.0 |
| E6348G6 | Green | #2 | 33.6 |
| E6363G1 | Black | 2/0 | 67.4 |
| E6363G2 | Black | 3/0 | 85.0 |
| E6363G6 | Black | #2 | 33.6 |

2 pole housing & 320 amp contacts continued

| Part Number | Housing Color | Wire | |
|-------------|---------------|------|--------|
| | | AWG | sq. mm |
| E6364G1 | Yellow | 2/0 | 67.4 |
| E6364G2 | Yellow | 3/0 | 85.0 |
| E6364G6 | Yellow | #2 | 33.6 |
| E6369G1 | Orange | 2/0 | 67.4 |
| E6369G2 | Orange | 3/0 | 85.0 |
| E6369G6 | Orange | #2 | 33.6 |

2 Pole Housing, Contacts & Auxiliary Contacts

| Part Number | Housing Color | Wire | |
|-------------|---------------|------|--------|
| | | AWG | sq. mm |
| E6332G1 | Brown | 2/0 | 67.4 |
| E6332G2 | Brown | 3/0 | 85.0 |
| E6332G6 | Brown | N/A | 35.0 |
| E6333G1 | Purple | 2/0 | 67.4 |
| E6333G2 | Purple | 3/0 | 85.0 |
| E6333G6 | Purple | N/A | 35.0 |
| E6340G1 | Gray | 2/0 | 67.4 |
| E6340G2 | Gray | 3/0 | 85.0 |

2 pole housing, contacts & auxiliary contacts continued

| Part Number | Housing Color | Wire | |
|-------------|---------------|------|--------|
| | | AWG | sq. mm |
| E6340G6 | Gray | N/A | 35.0 |
| E6341G1 | Blue | 2/0 | 67.4 |
| E6341G2 | Blue | 3/0 | 85.0 |
| E6341G6 | Blue | N/A | 35.0 |
| E6342G1 | Red | 2/0 | 67.4 |
| E6342G2 | Red | 3/0 | 85.0 |
| E6342G6 | Red | N/A | 35.0 |
| E6343G1 | Green | 2/0 | 67.4 |
| E6343G2 | Green | 3/0 | 85.0 |
| E6343G6 | Green | N/A | 35.0 |
| E6359G1 | Black | 2/0 | 67.4 |
| E6359G2 | Black | 3/0 | 85.0 |
| E6359G6 | Black | N/A | 35.0 |
| E6360G1 | Yellow | 2/0 | 67.4 |
| E6360G2 | Yellow | 3/0 | 85.0 |
| E6360G6 | Yellow | N/A | 35.0 |
| E6368G1 | Orange | 2/0 | 67.4 |
| E6368G2 | Orange | 3/0 | 85.0 |
| E6368G6 | Orange | N/A | 35.0 |

Note: For additional colors please contact customer service

HEADQUARTERS: 13 Pratts Junction Road, P.O. Box 579, Sterling, MA 01564 T:978-422-3600 F:978-422-3700

EUROPE: Rathealy Road, Fermoy Co. Cork, Ireland T:353-(0)25-32277 F:353-(0)25-32296

ASIA/PACIFIC: IDEAL Anderson Asia Pacific Ltd., Unit 922-928 Topsail Plaza, 11 On Sum Street, Shatin N.T., Hong Kong T:852-2636-0836 F:852-2635-9036

CHINA: IDEAL Anderson Technologies (Shenzhen) Ltd., Block A8 Tantou W. Ind. Par, Songgang Baoan District, Shenzhen, PR. China 51810 T: 86-755-2768-2118 F: 86-755-2768-2218

TAIWAN: IDEAL Anderson Asia Pacific Ltd., Taiwan Branch, 4F-2, No.116, Dadun 20th St., Situn District, Taichung City 407, Taiwan (R.O.C.) T: 886-4-2310-6451 F:886-4-2310-6460

www.andersonpower.com

ORDERING INFORMATION

Housings Only

| Part Number | Color |
|-------------|--------|
| E6350 | Gray |
| E6351 | Blue |
| E6350 | Gray |
| E6351 | Blue |
| E6352 | Red |
| E6353 | Green |
| E6361 | Black |
| E6362 | Yellow |
| E6339 | Orange |
| E6336 | Brown |
| E6349 | Purple |

Contacts

| Part Number | Description | Wire | |
|-------------|-----------------|------|--------|
| | | AWG | sq. mm |
| 6354 | Contact set (2) | 2/0 | 67.4 |
| 6355 | Contact set (2) | 3/0 | 85.0 |
| 6356 | Contact set (2) | 4/0 | 107.2 |
| 6394 | Contact set (2) | | 35.0 |
| 1341G1 | DIN standard | | 50.0 |
| 1341G2 | DIN standard | | 70.0 |
| 1341G3 | DIN standard | | 95.0 |

Bushings

| Part Number | Description | Wire | |
|-------------|--|------------|---------------|
| | | AWG | sq. mm |
| 5687 | For use with 6354 contact & 5918 bushing | 1/0 to #1 | 53.5 to 42.4 |
| 5690 | For use with 6354 contact & 5918 bushing | 1/0 to #2 | 53.5 to 33.6 |
| 5693 | For use with 6354 contact & 5918 bushing | 1/0 to #4 | 53.5 to 21.2 |
| 5663 | For use with 6354 contact & 5918 bushing | 1/0 to #6 | 53.5 to 13.3 |
| 5648 | For use with 6354 contact & 5918 bushing | 1/0 to #10 | 53.5 to 5.3 |
| 5918 | For use with 6354 contact | 2/0 to 1/0 | 67.43 to 53.5 |
| 5920 | For use with 6394 contact | N/A | 35 to 16mm |

Accessories

| Part Number | Description |
|-------------|--|
| 6367G1 | Pin kit #16/12 (1.31/3.31mm)-for battery |
| 6366G2 | Tube kit #16/12 (1.31/3.31mm)-for charger & truck |
| 6337G1 | Charger key |
| 995G2 | Handle with hardware "A" frame |
| 993G1 | Manual release-battery bracket with hardware |
| 994G1 | Manual release-charger/truck bracket with hardware |
| 911G2 | Cable clamps-use alone with manual release or "A" frame handle |
| 6305G1 | Auxiliary contact kit with contact part number 1331 |
| 6310G1 | Auxiliary contact kit with contact part number 1332 |

Tooling

| Part Number | Description |
|-------------|---|
| 970P1 | Extraction tool-insulatd handle |
| 111038G2 | Contact insertion/extraction tool for auxiliary contact kit |
| 1368 | Hand tool for 1/0 to 95mm (53.5/95) |
| 1387G1 | Pneumatic tool |
| 1387G2 | Pneumatic tool |
| 1388G2 | - die for 2/0 to 4/0 (53.5/107.2) |
| 1388G9 | - die for 35mm |
| 1389G2 | - locator for 2/0 to 4/0 (53.5/107.2) |
| 1303G7 | - die for 70mm |
| 1303G8 | - die for 50mm |
| 1304G7 | - locator for 70mm |
| 1304G8 | - locator for 50mm |

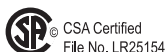

All Data Subject To Change Without Notice

HEADQUARTERS: 13 Pratts Junction Road, P.O. Box 579, Sterling, MA 01564 T:978-422-3600 F:978-422-3700

EUROPE: Rathealy Road, Fermoy Co. Cork, Ireland T:353-(0)25-32277 F:353-(0)25-32296

ASIA/PACIFIC: IDEAL Anderson Asia Pacific Ltd., Unit 922-928 Topsail Plaza, 11 On Sum Street, Shatin N.T., Hong Kong T:852-2636-0836 F:852-2635-9036

CHINA: IDEAL Anderson Technologies (Shenzhen) Ltd., Block A8 Tantou W. Ind. Par, Songgang Baoan District, Shenzhen, P.R. China 51810 T: 86-755-2768-2118 F: 86-755-2768-2218

TAIWAN: IDEAL Anderson Asia Pacific Ltd., Taiwan Branch, 4F-2, No.116, Dadun 20th St., Situn District, Taichung City 407, Taiwan (R.O.C.) T: 886-4-2310-6451 F:886-4-2310-6460

www.andersonpower.com

TEMPERATURE RISE CHART

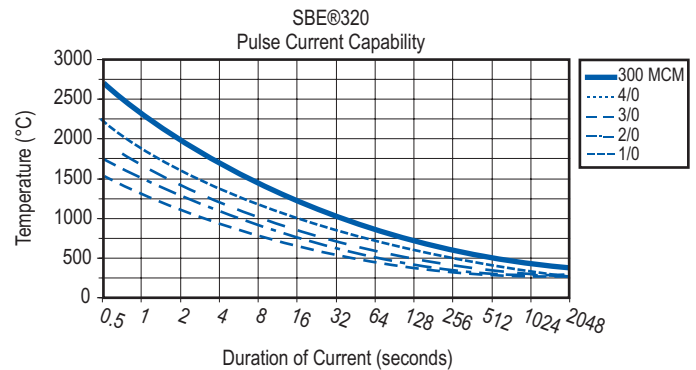
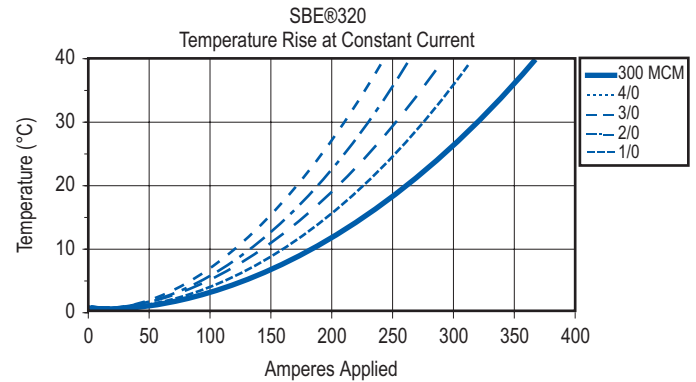

DIMENSIONS

Housing

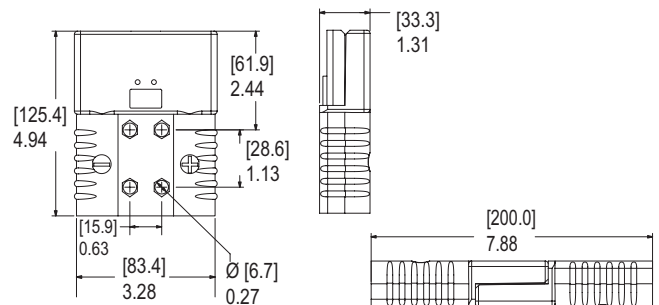

Contacts

| | -A- | -B- | -C- | -D- | -E- |
|--------|-----------|-----------|-----------|-----------|-----------|
| | mm in. | mm in. | mm in. | mm in. | mm in. |
| 6354 | 78.2 3.08 | 16.3 0.64 | 12.4 0.49 | 32.8 1.29 | 20.6 0.81 |
| 6355 | 78.2 3.08 | 17.9 0.70 | 14.7 0.58 | 31.2 1.23 | 20.6 0.81 |
| 6356 | 78.2 3.08 | 19.1 0.75 | 16.3 0.64 | 32.5 1.28 | 20.6 0.81 |
| 6394 | 78.2 3.08 | 13.0 0.51 | 9.5 0.38 | 32.3 1.27 | 20.6 0.81 |
| 1341G1 | 67.3 2.65 | 14.5 0.57 | 10.9 0.43 | 20.7 0.82 | 20.6 0.81 |
| 1341G2 | 69.6 2.74 | 17.3 0.68 | 13.0 0.51 | 20.7 0.82 | 20.6 0.81 |
| 1341G3 | 73.4 2.89 | 19.8 0.78 | 15.0 0.59 | 24.6 0.97 | 20.6 0.81 |

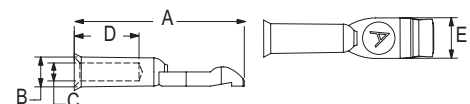

The SBE 700 connector is UL listed and certified to meet EPRI Conductive Fast Charge Connector specifications, with a continuous current capacity of 700 amperes. The SBE 700 allows the use of a single connector to meet the tough demands of high current traction battery rapid charging.

Rugged and durable, the connector is capable of 10,000 mating cycles. The SBE 700 connector is keyed and touch safe offering improved user safety. The integrated non-metallic cable clamp further improves user safety by restricting cable insulation creep and increases the ruggedness of the connector/cable assembly. Up to ten optional auxiliary contacts are also available for sensing and communications.

The SBE 700 is designed and manufactured to the same high standards and stringent specifications that have made APP the leader in high power connectors.

FEATURES

- **700 amp continuous current**

The SBE 700 eliminates the need for more than one connector to achieve high current charging

- **Up to ten optional auxiliary contacts**

Provide sensing and communications circuits for any battery charging/monitoring system

- **Field replaceable power contacts utilize industry standard cables**

Tool removable, crimp contacts use 250 MCM or 4/0 cables eliminating high cost specialty cables

- **Touch safe, keyed design**

The connector body prevents inadvertent touching of the main power contacts. Connector specific keying can be ordered to insure only matching connectors can be mated

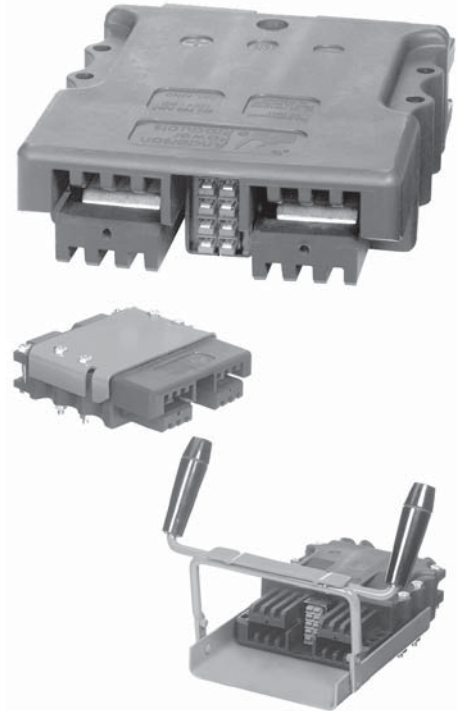

PRODUCT SPECIFICATIONS

Power Contacts

| | |
|--|--|
| Number of High Current Contacts | 2 |
| Contact Barrel Size (AWG or MCM) (flexible Stranded Class I, K, M, Types W or EV) | 2 x 4/0 = 600amp 2 x 250MCM = 700 amp |
| UL Current Rating (amperes DC)* | 700 |
| Contact to Wire Retention Force (lbf) | 250 |
| Life at No Load (Contact Connect/Disconnect Cycles) | 10,000 |
| Finger proof | UL 1977 |

Complete Unit

| | |
|---|--------------|
| Voltage Rating (volts DC) | 150 |
| Insulation Withstanding Test Voltage (volts DC) | 1300 |
| Operating Temperature Range °C | -40° to 120° |
| Temperature Rise at Nominal Load °C | 50 |
| Average Insertion/extraction Force (lbf. with handle) | 30 |
| Flammability Rating of Housing Material | PBT, UL94 HB |

Signal / Auxiliary Contacts

| | |
|--|----------|
| Number of Signal/Auxiliary Contacts (Powerpole and/or Pin & Socket) | 0 to 10 |
| Contact Wire Size (AWG) | 10 to 20 |
| Contact Wire Size (mm ²) | 4 to .5 |
| Contact Current Rating (amperes DC) | 30 |
| Control pilot delay vs. power contacts (millisecond) | 35 |
| Contact housing retention force (lbf) | 25 |
| Life at No Load (Contact Connect/Disconnect Cycles) | 10,000 |



* For largest wire or cable size.

HEADQUARTERS: 13 Pratts Junction Road, P.O. Box 579, Sterling, MA 01564 T:978-422-3600 F:978-422-3700

EUROPE: Rathealy Road, Fermoy Co. Cork, Ireland T:353-(0)25-32277 F:353-(0)25-32296

ASIA/PACIFIC: IDEAL Anderson Asia Pacific Ltd., Unit 922-928 Topsail Plaza, 11 On Sum Street, Shatin N.T., Hong Kong T:852-2636-0836 F:852-2635-9036

CHINA: IDEAL Anderson Technologies (Shenzhen) Ltd., Block A8 Tantou W. Ind. Par, Songgang Baoan District, Shenzhen, P.R. China 51810 T: 86-755-2768-2118 F: 86-755-2768-2218

TAIWAN: IDEAL Anderson Asia Pacific Ltd., Taiwan Branch, 4F.-2, No.116, Dadun 20th St., Situn District, Taichung City 407, Taiwan (R.O.C.) T: 886-4-2310-6451 F:886-4-2310-6460

www.andersonpower.com

ORDERING INFORMATION

Connectors

| Part Number | Description |
|-------------|--|
| 700G1 | 700A housing, contacts, and clamp |
| 707G1 | 700A housing, contacts, clamp, and release lever & bracket for battery connector |
| 708G1 | 700A housing, contacts, clamp, and latch plate for truck/charger connector |
| 709G1 | 700A housing, contacts, clamp, release lever & bracket for battery connector and auxiliary housing |
| 710G1 | 700A contacts, clamp, latch plate for truck/charger connector and auxiliary housing |

Components

| Part Number | Description |
|-------------|--|
| 702G1 | Housing only |
| 703G1 | Auxiliary contact housing only (ten auxiliary connectors and/or spacers needed to fill auxiliary housing) |
| 704G1 | Cable Clamp only |
| 705G1 | Release lever & bracket for battery connector (mates with 706G1) |
| 706G1 | Latch plate for truck/charger connector (mates with 705G1) |
| 6170G1 | 700A Contact Set |
| 5954 | Bushing 4/0 AWG (107.2 mm) |

Powerpole® Auxiliary Connectors

| Part Number | Description |
|-------------|--|
| 1327 | Red housing |
| 1327G5 | Green housing |
| 1327G6 | Black housing |
| 1327G7 | White housing |
| 1327G8 | Blue housing |
| 1327G16 | Yellow housing |
| 1327G17 | Orange housing |
| 1327G18 | Gray housing |
| 1327G21 | Brown housing |
| 1327G22 | Pink housing |
| 1327G23 | Purple housing |
| 1399G6 | Red short spacer without hole |
| 1331 | 30 amp contact 12/16 AWG (3.3/1.3 mm) |
| 1332 | 15 amp contact 16/20 AWG (1.3/1.52 mm) |

Tooling

| Part Number | Description |
|-------------|---------------------------------------|
| Y750 | Hydraulic Crimp Tool - FCI Burndy |
| U34RT | Crimp Die - FCI Burndy |
| 1309G2 | Hand tool for auxiliary contacts |
| 1367G1 | Pneumatic tool for auxiliary contacts |

TEMPERATURE RISE CHART

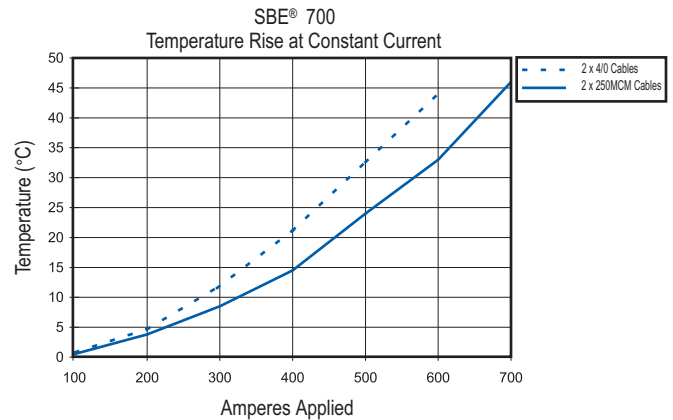

DIMENSIONS

Housing

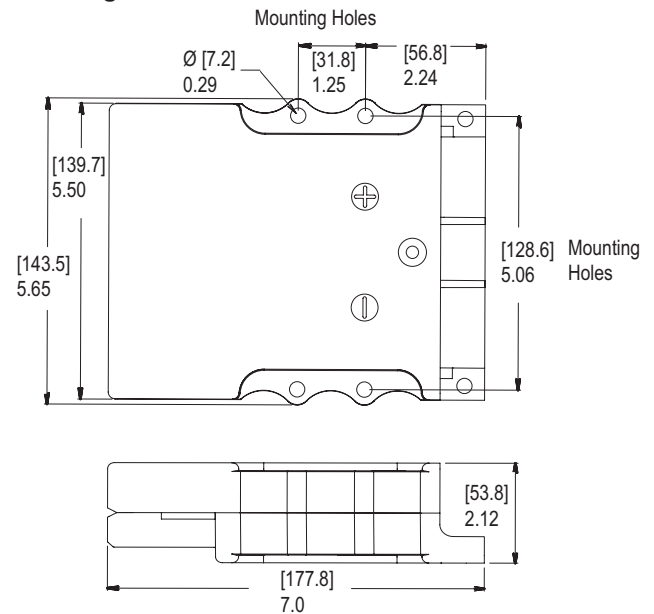

Contact

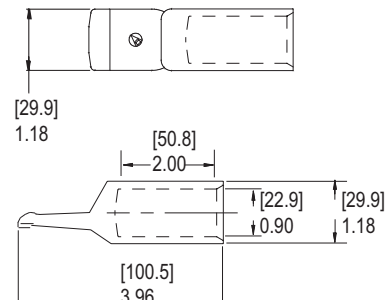

CSA Certified
File No. LR25154



UL US
File No. E26226

Patent No. 6,997,730

All Data Subject To Change Without Notice

Note: For additional colors please contact customer service

HEADQUARTERS: 13 Pratts Junction Road, P.O. Box 579, Sterling, MA 01564 T:978-422-3600 F:978-422-3700

EUROPE: Rathealy Road, Fermoy Co. Cork, Ireland T:353-(0)25-32277 F:353-(0)25-32296

ASIA/PACIFIC: IDEAL Anderson Asia Pacific Ltd., Unit 922-928 Topsail Plaza, 11 On Sum Street, Shatin N.T., Hong Kong T:852-2636-0836 F:852-2635-9036

CHINA: IDEAL Anderson Technologies (Shenzhen) Ltd., Block A8 Tantou W. Ind. Par. Songgang Baoan District, Shenzhen, P.R. China 51810 T: 86-755-2768-2118 F: 86-755-2768-2218

TAIWAN: IDEAL Anderson Asia Pacific Ltd., Taiwan Branch, 4F.-2, No.116, Dadun 20th St., Situn District, Taichung City 407, Taiwan (R.O.C.) T: 886-4-2310-6451 F:886-4-2310-6460

www.andersonpower.com



Connector Notes

For customer drawings, assembly instructions and individual data sheets, please visit www.andersonpower.com

HEADQUARTERS: 13 Pratts Junction Road, P.O. Box 579, Sterling, MA 01564 T:978-422-3600 F:978-422-3700

EUROPE: Rathealy Road, Fermoy Co. Cork, Ireland T:353-(0)25-32277 F:353-(0)25-32296

ASIA/PACIFIC: IDEAL Anderson Asia Pacific Ltd., Unit 922-928 Topsail Plaza, 11 On Sum Street, Shatin N.T., Hong Kong T:852-2636-0836 F:852-2635-9036

CHINA: IDEAL Anderson Technologies (Shenzhen) Ltd., Block A8 Tantou W. Ind. Par, Songgang Baoan District, Shenzhen, P.R. China 51810 T: 86-755-2768-2118 F: 86-755-2768-2218

TAIWAN: IDEAL Anderson Asia Pacific Ltd., Taiwan Branch, 4F.-2, No.116, Dadun 20th St., Situn District, Taichung City 407, Taiwan (R.O.C.) T: 886-4-2310-6451 F:886-4-2310-6460

www.andersonpower.com

FEATURES

- **Auxiliary contacts**

Provides additional poles up to 30 amps for auxiliary power, control or sensing

- **Meets UL 1950 finger probe test**

Each half offers finger proofing and can be connected to two energized sources up to 600 volts AC/DC

- **Handle**

Eases connector use and relieves unnecessary strain on cables when disconnecting

- **Mechanical keyed housings**

Prevents accidental mating of components operating at different voltage levels

- **Genderless design**

Makes assembly quick and easy and reduces number of parts stocked

- **Flat wiping contact system**

Allows for minimal contact resistance at high current, wiping action cleans contact surface during disconnection

- **UL approved for current interrupt**

Safe for "Hot Plug" of battery power

- **UL94 V-0 housing material**

Provides security in knowledge that the connector chosen meets strict UL flammability ratings



PRODUCT RANGE

| | |
|--|--------------|
| UL Current Rating (Amperes)* | 60 |
| Contact Barrel Wire Size (AWG) | #6 |
| (mm ²) | 16 |
| Maximum Wire Insulation Diameter (inches) | 0.44 |
| (mm ²) | 11.12 |
| AVG Contact Resistance* (micro-ohms) | 200 |
| Insulation Withstanding Test Voltage (Volts AC/DC) | 2200 |
| Contact Retention Force (lbf) | 50 to 500 |
| Life | |
| a. No load (Contact/Disconnect Cycles) | To 10,000 |
| b. Under load (hot plug 250 cycles @ 120V) | 60A |
| Operating Temperature Range °C | -20° to 105° |
| °F | -4° to 221° |
| Flammability Rating of Housing Material | UL94 V-0 |



*UL rated for 65°C largest wire or cable size

PRODUCT INFORMATION

Anderson Power Products (APP), a leader in interconnect solutions, offers the highly durable SBO60 multipole connector. The new genderless SBO60 power connector contains recessed contacts and a ribbed nose housing, providing finger proofing in environments where human contact is a consideration.

The SBO60 connector's single piece housing provides industrial quality and durability for hot pluggable demands. The 4-pole SBO60 connector offers a V0 rating and is available in different colors, while being mechanically keyed to ensure connectors will only mate with connectors of the same color. The different color housings indicate different voltages.

The compact SBO60 has silver-plated copper contacts, offering a maximum connect/disconnect life of 10,000 cycles in AC/DC applications. SBO60 connectors are designed to have a self-wiping action which assures greater conductivity and longer life. Additionally, SBO60 connectors feature auxiliary contacts allowing two additional poles of up to 30 amps capability to be used for auxiliary power, control, or sensing.

APP's SBO60 is a fully insulated 60 amp connector designed for applications requiring high-current power connections to an AC or DC source up to 600 volts. The SBO60 has applications in: Office Settings, UPS Battery Backup Systems, Telecommunications, Medical, Electrical, Electronic and Electric Vehicles.



File No. LR25154 File No. E26226 All Data Subject To Change Without Notice

HEADQUARTERS: 13 Pratts Junction Road, P.O. Box 579, Sterling, MA 01564 T:978-422-3600 F:978-422-3700

EUROPE: Rathealy Road, Fermoy Co. Cork, Ireland T:353-(0)25-32277 F:353-(0)25-32296

ASIA/PACIFIC: IDEAL Anderson Asia Pacific Ltd., Unit 922-928 Topsail Plaza, 11 On Sum Street, Shatin N.T., Hong Kong T:852-2636-0836 F:852-2635-9036

CHINA: IDEAL Anderson Technologies (Shenzhen) Ltd., Block A8 Tantou W. Ind. Par, Songgang Baoan District, Shenzhen, PR. China 51810 T: 86-755-2768-2118 F: 86-755-2768-2218

TAIWAN: IDEAL Anderson Asia Pacific Ltd., Taiwan Branch, 4F.-2, No.116, Dadun 20th St., Situn District, Taichung City 407, Taiwan (R.O.C.) T: 886-4-2310-6451 F:886-4-2310-6460

www.andersonpower.com

The SBO®60 connector is for hot-plug use at 60 amps. It contains recessed contacts and a ribbed nose housing, thus providing finger proofing in environments where human contact is a consideration. Available in different colors, this genderless connector is mechanically keyed to ensure connectors will only mate with connectors of the same color.

With the silver-plated copper contacts, there is a maximum connect/disconnect life of 10,000 cycles, with a 600 volts continuous AC or DC operation. Accessories, such as integral cable clamp and handle, provide strain relief and ease of use.

FEATURES

- Auxiliary contacts**
Provides additional poles up to 30 amps for auxiliary power, control or sensing
- Meets UL 1950 finger probe test**
Each half offers finger proofing and can be connected to two energized sources up to 600 volts AC/DC
- Handle**
Eases connector use and relieves unnecessary strain on cables when disconnecting

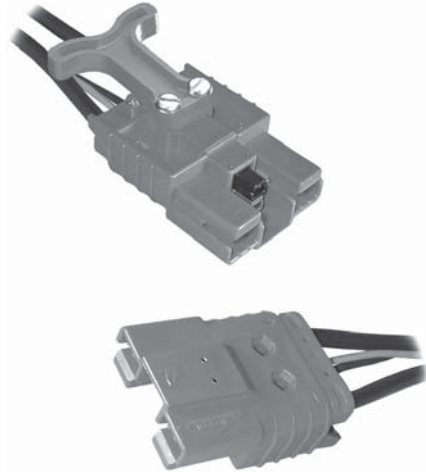

PRODUCT SPECIFICATIONS

| Connector Model | SBO®60 | Connector Model | SBO®60 |
|---|----------------------|---|--------|
| Current rating (main contacts) | 60 | Insulation with standing test voltage (volts AC/DC) | 2200 |
| Largest wire size (AWG) | #6 | Maximum wire insulation diameter (inches) | 0.44 |
| (mm ²) | 16 | (mm) | 11.2 |
| Maximum operating voltage AC/DC | 600 | Contact retention force (lbf) | 50 |
| Contact material | Silver plated copper | Life: | |
| Operating temperature range °C | -20° to 105° | a. No load (connect/disconnect cycles) | 10,000 |
| °F | -4° to 221° | b. Under load (hot plug 250 cycles @ 120V) | 60A |
| Flammability rating of housing material | UL94 V-0 | | |
| AVG contact resistance* (microhoms) | 200 | | |



*UL rated for 65°C largest wire or cable size

ORDERING INFORMATION

Housing Only

| Part Number | Housing Color |
|-------------|---------------|
| SBO60RED | Red |
| SBO60YEL | Yellow |
| SBO60ORN | Orange |
| SBO60WHT | White |

Contacts

| Part Number | Description | Wire AWG | Wire sq. mm |
|-------------|-----------------|----------|-------------|
| 1339G1 | Contact set (2) | #6 | 16 |

Bushings

| Part Number | Description | Wire AWG | Wire sq. mm |
|-------------|-----------------|--------------|---------------|
| 5912 | Use with 1339G1 | #6 to #8 | 16/8.4 |
| 5910 | Use with 1339G1 | #6 to #10/12 | 16 to 5.3/3.3 |

Cable Clamp & Hardware

| Part Number | Housing Color |
|-------------|---------------|
| SBO60CLPRED | Red |

Handle/Hardware & Accessories

| Part Number | Description |
|-------------|-----------------------|
| SBO60HDLRED | Red housing |
| 6344 | Auxiliary contact kit |

Housing, Contacts, Handle, Clamp & Hardware

| Part Number | Housing Color |
|-----------------|---------------|
| SBO60RED16MMHDL | Red |
| SBO60YEL16MMHDL | Yellow |
| SBO60ORN16MMHDL | Orange |
| SBO60WHT16MMHDL | White |

Tooling

| Part Number | Description |
|-------------|----------------------------|
| 1309G4 | Hand tool |
| 1387G1 | Pneumatic tool |
| 1388G6 | - die for #6 AWG/16 mm |
| 1389G9 | - locator for #6 AWG/16 mm |

Note: For additional colors please contact customer service

HEADQUARTERS: 13 Pratts Junction Road, P.O. Box 579, Sterling, MA 01564 T:978-422-3600 F:978-422-3700

EUROPE: Rathealy Road, Fermoy Co. Cork, Ireland T:353-(0)25-32277 F:353-(0)25-32296

ASIA/PACIFIC: IDEAL Anderson Asia Pacific Ltd., Unit 922-928 Topsail Plaza, 11 On Sum Street, Shatin N.T., Hong Kong T:852-2636-0836 F:852-2635-9036

CHINA: IDEAL Anderson Technologies (Shenzhen) Ltd., Block A8 Tantou W. Ind. Par, Songgang Baoan District, Shenzhen, PR. China 51810 T: 86-755-2768-2118 F: 86-755-2768-2218

TAIWAN: IDEAL Anderson Asia Pacific Ltd., Taiwan Branch, 4F-2, No.116, Dadun 20th St., Situn District, Taichung City 407, Taiwan (R.O.C.) T: 886-4-2310-6451 F:886-4-2310-6460

www.andersonpower.com

DIMENSIONS

Housing

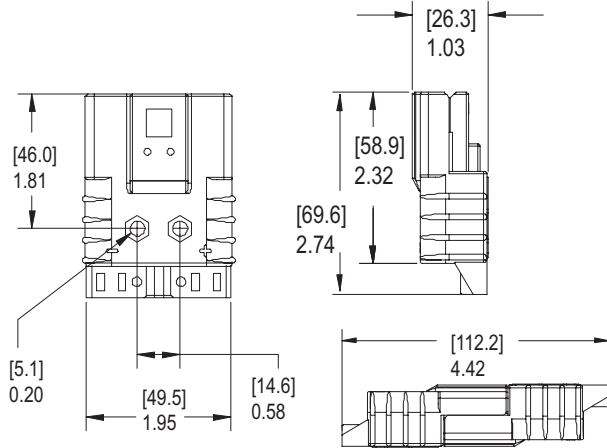

TEMPERATURE RISE CHART

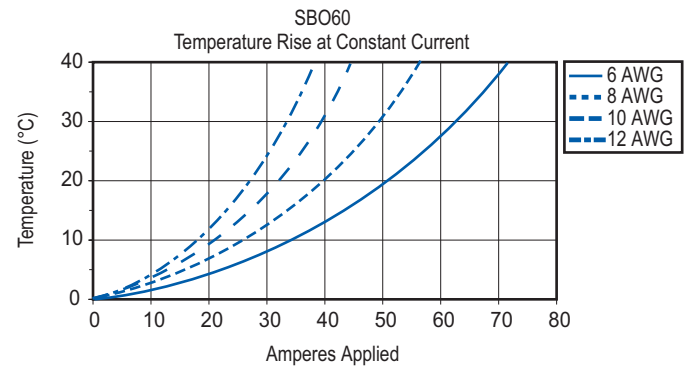

Contacts

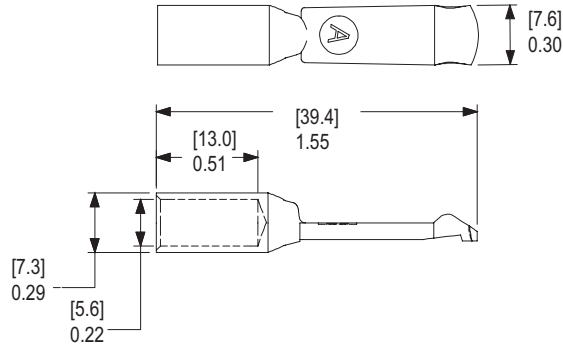



Connector Notes

For customer drawings, assembly instructions and individual data sheets, please visit www.andersonpower.com

HEADQUARTERS: 13 Pratts Junction Road, P.O. Box 579, Sterling, MA 01564 T:978-422-3600 F:978-422-3700

EUROPE: Rathealy Road, Fermoy Co. Cork, Ireland T:353-(0)25-32277 F:353-(0)25-32296

ASIA/PACIFIC: IDEAL Anderson Asia Pacific Ltd., Unit 922-928 Topsail Plaza, 11 On Sum Street, Shatin N.T., Hong Kong T:852-2636-0836 F:852-2635-9036

CHINA: IDEAL Anderson Technologies (Shenzhen) Ltd., Block A8 Tantou W. Ind. Par, Songgang Baoan District, Shenzhen, P.R. China 51810 T: 86-755-2768-2118 F: 86-755-2768-2218

TAIWAN: IDEAL Anderson Asia Pacific Ltd., Taiwan Branch, 4F.-2, No.116, Dadun 20th St., Situn District, Taichung City 407, Taiwan (R.O.C.) T: 886-4-2310-6451 F:886-4-2310-6460

www.andersonpower.com

FEATURES

- Mechanical keyed housings**
Prevents accidental mating of components operating at different voltage levels
- Auxiliary contacts**
Provides ability to incorporate a secondary sensor control circuit
- Single-piece housing and unitized construction**
Provides industrial quality and durability
- Optional air supply system**
Supplies air to battery during charging
- Genderless design**
Makes assembly quick and easy and reduces number of parts stocked
- Optional mechanical release**
Aids mating and unmating for high cycle battery charging
- UL94 V-0 housing material**
Provides security in knowledge that the connector chosen meets strict UL flammability ratings



PRODUCT RANGE

| | |
|---|----------------|
| UL Current Rating (Amperes)* | 175 to 350* |
| UL Voltage Ratings (Volts) | 600* |
| Contact Barrel Wire Size (AWG) | 1/0 to 300 mcm |
| (mm ²) | 53.5 to 152 |
| Maximum Wire Insulation Diameter (inches) | 0.75 to 1.10 |
| (mm) | 19.1 to 27.9 |
| AVG Contact Resistance* (micro-ohms) | 100 to 50 |
| Insulation Withstanding | 2200 |
| Test Voltage (Volts AC/DC) | |
| Contact Retention Force (lbf) | 300 to 500 |
| Life | |
| a. No load (Contact/Disconnect Cycles) | To 10,000 |
| b. Under Load (Hot Plug250 cycles @ 120V) | 75A to 100A* |
| Avg. Connection/Disconnect (lbf) | 25 to 30 |
| Operating Temperature Range °C** | -20° to 105° |
| Flammability Rating of Housing Material | UL94 V-0 |

Recommended Voltage Key Color Code

| | | | | | | | | | | |
|---------|--------|--------|-----|------|------|-------|-------|-------|--------|-------|
| Voltage | 12V | 18V | 24V | 36V | 48V | 72V | 80V | 96V | 120V | 144V |
| Color | Yellow | Orange | Red | Gray | Blue | Green | Black | Brown | Purple | White |



* UL Rated for 65°C largest wire or cable size
 ** Contact factory for higher temperature rated connectors

PRODUCT INFORMATION

Invented by Anderson Power Products®, the innovative SBX® connectors provide cost-effective reliability, design flexibility and safety for your products' manufacture, installation and maintenance. APP's 2 pole connectors are available for 175 and 350 amp ratings for use to 600 Volts continuous AC or DC operation. There are SBX® connectors for many applications and wire sizes, 1/0 (53.5mm²) to 300 mcm (152mm²). Mechanical keys ensure connectors will only mate with connectors of the same color. Different color housings are selected to identify voltages, thus preventing mismatching of the power supply system.

The housings are interchangeable, genderless interconnects. Insert contacts into housings and plug together for a clever, simple and low-cost solution to power interconnection.

Markets: UPS Systems, Telecommunications, Forklift Trucks, Wheelchairs, EV, Chargers, Power Electronics & Much More.



File No. LR25154 File No. E26226 All Data Subject To Change Without Notice

HEADQUARTERS: 13 Pratts Junction Road, P.O. Box 579, Sterling, MA 01564 T:978-422-3600 F:978-422-3700

EUROPE: Rathealy Road, Fermoy Co. Cork, Ireland T:353-(0)25-32277 F:353-(0)25-32296

ASIA/PACIFIC: IDEAL Anderson Asia Pacific Ltd., Unit 922-928 Topsail Plaza, 11 On Sum Street, Shatin N.T., Hong Kong T:852-2636-0836 F:852-2635-9036

CHINA: IDEAL Anderson Technologies (Shenzhen) Ltd., Block A8 Tantou W. Ind. Par, Songgang Baoan District, Shenzhen, P.R. China 51810 T: 86-755-2768-2118 F: 86-755-2768-2218

TAIWAN: IDEAL Anderson Asia Pacific Ltd., Taiwan Branch, 4F.-2, No.116, Dadun 20th St., Situn District, Taichung City 407, Taiwan (R.O.C.) T: 886-4-2310-6451 F:886-4-2310-6460

www.andersonpower.com

The innovative SBX[®] connectors provide cost-effective reliability, design flexibility and safety for your products' manufacture, installation and maintenance.

APP's 2 pole connector is available with a 175 amp rating, 600 Volts continuous AC or DC operation. There are SBX[®] connectors for many applications and wire sizes, 1/0 or 35 mm. Mechanical keys ensure connectors will only mate with connectors of the same color. Different color housings are selected to identify voltages, thus preventing mismatching of the power supply system.

FEATURES

- Mechanical keyed housings**
Prevents accidental mating of components operating at different voltage levels
- Auxiliary contacts**
Provides ability to incorporate a secondary sensor control circuit
- Optional mechanical release**
Aids mating and unmating for high cycle battery charging



PRODUCT SPECIFICATIONS

| Connector Model | SBX [®] 175 | Connector Model | SBX [®] 175 |
|--|----------------------|--|----------------------|
| UL Current Rating (Amperes)* | 175* | Life | |
| UL Voltage Ratings (Volts) | 600* | a. No load (Contact/Disconnect Cycles) | To 10,000 |
| Contact Barrel Wire Size | 1/0 to 35 mm | b. Under Load (Hot Plug 250 cycles @ 120V) | 75A |
| Maximum Wire Insulation Diameter (inches) | 0.75 | Avg. Connection/Disconnect (lbf) | 25 |
| (mm) | 19.1 | Operating Temperature Range °C** | -20° to 105° |
| Maximum Wire Insulation Diameter | | °F | -4° to 221° |
| AVG Contact Resistance* (micro-ohms) | 100 | Flammability Rating of Housing Material | UL94 V-0 |
| Insulation Withstanding Test Voltage (Volts AC/DC) | 2200 | | |
| Contact Retention Force (lbf) | 300 | | |



* UL Rated for 65°C largest wire or cable size

** Contact factory for higher temperature rated connector

ORDERING INFORMATION

2 Pole Housing, 175 amp Contacts, & Auxiliary Contacts

| Part Number | Housing Color | Wire | |
|-------------|---------------|------|--------|
| | | AWG | sq. mm |
| 6370G1 | Gray | 1/0 | 53.5 |
| 6371G1 | Blue | 1/0 | 53.5 |
| 6372G1 | Orange | 1/0 | 53.5 |
| 6373G1 | Yellow | 1/0 | 53.5 |
| 6378G1 | Red | 1/0 | 53.5 |
| 6387G1 | Green | 1/0 | 53.5 |
| 6378G2 | Red | 35 | - |
| 6387G2 | Green | 35 | - |
| 6370G2 | Gray | 35 | - |
| 6371G2 | Blue | 35 | - |
| 6372G2 | Orange | 35 | - |
| 6373G2 | Yellow | 35 | - |

2 Pole Housing & Contacts

| Part Number | Housing Color | Wire | |
|-------------|---------------|------|--------|
| | | AWG | sq. mm |
| 6374G1 | Gray | 1/0 | 53.5 |
| 6375G1 | Blue | 1/0 | 53.5 |
| 6376G1 | Orange | 1/0 | 53.5 |
| 6377G1 | Yellow | 1/0 | 53.5 |
| 6379G1 | Red | 1/0 | 53.5 |
| 6391G1 | Green | 1/0 | 53.5 |
| 6374G2 | Gray | 35 | - |
| 6375G2 | Blue | 35 | - |
| 6376G2 | Orange | 35 | - |
| 6377G2 | Yellow | 35 | - |
| 6379G2 | Red | 35 | - |
| 6391G2 | Green | 35 | - |

Housings Only

| Part Number | Color |
|-------------|--------|
| 6380G1 | Gray |
| 6381G1 | Blue |
| 6382G1 | Orange |
| 6383G1 | Yellow |
| 6385G1 | Red |
| 6390G1 | Green |

Contacts

| Part Number | Description | Wire | |
|-------------|-----------------|------|--------|
| | | AWG | sq. mm |
| 6384G1 | Contact set (2) | 1/0 | 53.5 |
| 6384G2 | Contact set (2) | N/A | 35 |

Note: For additional colors please contact customer service

HEADQUARTERS: 13 Pratts Junction Road, P.O. Box 579, Sterling, MA 01564 T:978-422-3600 F:978-422-3700

EUROPE: Rathealy Road, Fermoy Co. Cork, Ireland T:353-(0)25-32277 F:353-(0)25-32296

ASIA/PACIFIC: IDEAL Anderson Asia Pacific Ltd., Unit 922-928 Topsail Plaza, 11 On Sum Street, Shatin N.T., Hong Kong T:852-2636-0836 F:852-2635-9036

CHINA: IDEAL Anderson Technologies (Shenzhen) Ltd., Block A8 Tantou W. Ind. Par, Songgang Baoan District, Shenzhen, PR. China 51810 T: 86-755-2768-2118 F: 86-755-2768-2218

TAIWAN: IDEAL Anderson Asia Pacific Ltd., Taiwan Branch, 4F-2, No.116, Dadun 20th St., Situn District, Taichung City 407, Taiwan (R.O.C.) T: 886-4-2310-6451 F:886-4-2310-6460

www.andersonpower.com

ORDERING INFORMATION

Accessories

| Part Number | Description |
|-------------|--|
| 6344 | Auxiliary contact kit |
| 6367G1 | Pin kit #16/12 (1.31/3.31mm)-for battery |
| 6337G1 | Charger key |
| 6366G2 | Charger key & socket |
| 995G1 | Handle with hardware "A" frame |
| 993G2 | Manual release-battery bracket with hardware |
| 994G2 | Manual release-charger/truck bracket with hardware |
| 945G2 | Cable clamps-use alone with manual release or "A" frame handle |

Bushings

| Part Number | Description | Wire | |
|-------------|---------------------|------------|--------------|
| | | AWG | sq. mm |
| 5687 | For use with 6384G1 | 1/0 to #1 | 53.5 to 42.4 |
| 5690 | For use with 6384G1 | 1/0 to #2 | 53.5 to 33.6 |
| 5693 | For use with 6384G1 | 1/0 to #4 | 53.5 to 21.2 |
| 5663 | For use with 6384G1 | 1/0 to #6 | 53.5 to 13.3 |
| 5648 | For use with 6384G1 | 1/0 to #10 | 53.5 to 5.3 |
| 5920 | For use with 6384G2 | N/A | 35mm to 16mm |

Tooling

| Part Number | Description |
|-------------|---|
| 969P1 | Extraction tool-insulatd handle |
| 111038G2 | Contact insertion/extraction tool for auxiliary contact kit |
| 1368 | Hand tool for 1/0 to 35mm (53.5/35) |
| 1387G1 | Pneumatic tool |
| 1388G3 | - die for 1/0 to #10 (53.5/5.26) |
| 1389G3 | - locator for 1/0 to #10 (53.5/5.26) |
| 1387G2 | - Pneumatic tool |
| 1303G4 | - die for #4 (21.1) |
| 1304G4 | - locator for #4 (21.1) |

DIMENSIONS

Housing

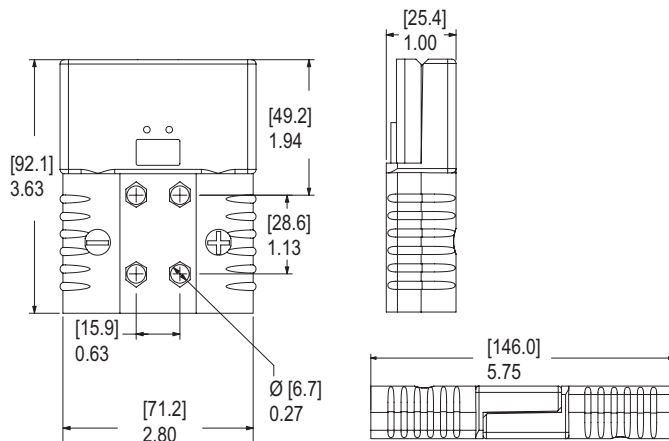

TEMPERATURE RISE CHART

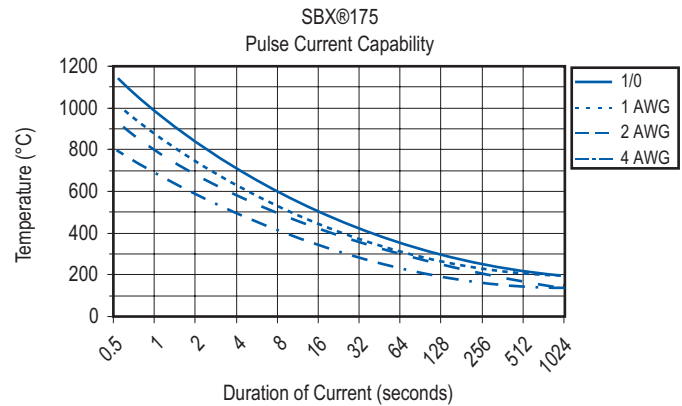
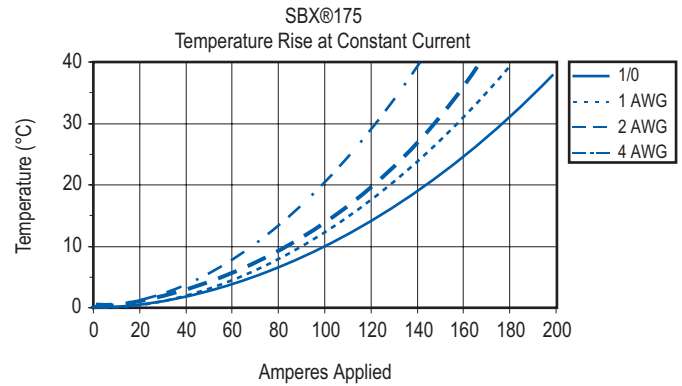

Contacts

| | -A- | | -B- | | -C- | | -D- | | -E- | |
|--------|------|------|------|------|------|------|------|------|------|------|
| | mm | in. | mm | in. | mm | in. | mm | in. | mm | in. |
| 6384G1 | 59.2 | 2.33 | 13.1 | 0.52 | 11.1 | 0.44 | 20.7 | 0.82 | 12.7 | 0.50 |
| 6384G2 | 59.2 | 2.33 | 13.1 | 0.52 | 9.5 | 0.38 | 20.7 | 0.82 | 12.7 | 0.50 |

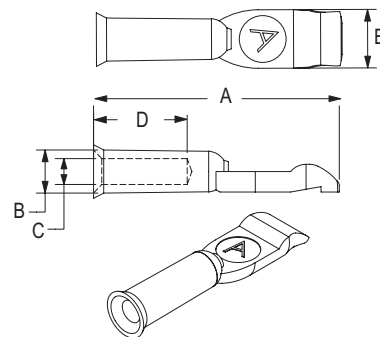

The innovative SBX[®] connectors provide cost-effective reliability, design flexibility and safety for your products' manufacture, installation and maintenance.

APP's 2 pole connector is available with a 350 amp rating, 600 Volts continuous AC or DC operation. There are SBX[®] connectors for many applications and wire sizes, 2/0 to 300 mcm (67.4 mcm to 152 mm).

Mechanical keys ensure connectors will only mate with connectors of the same color. Different color housings are selected to identify voltages, thus preventing mismatching of the power supply system.

FEATURES

- Mechanical keyed housings**
Prevents accidental mating of components operating at different voltage levels
- Auxiliary contacts**
Provides ability to incorporate a secondary sensor control circuit
- Optional mechanical release**
Aids mating and unmating for high cycle battery charging



PRODUCT SPECIFICATIONS

| Connector Model | SBX [®] 350 | Connector Model | SBX [®] 350 |
|---|-------------------------------|--|-----------------------------|
| UL Current Rating (Amperes)* | 350* | Life | |
| UL Voltage Ratings (Volts) | 600* | a. No load (Contact/Disconnect Cycles) | To 10,000 |
| Contact Barrel Wire Size (AWG) (mm ²) | 2/0 to 300 mcm 67.4 to 152 | b. Under Load (Hot Plug (250 cycles @ 120V)) | 100A |
| Maximum Wire Insulation Diameter (inches) (mm) | 1.10 27.9 | Avg. Connection/Disconnect (lbf) | 30 |
| AVG Contact Resistance* (micro-ohms) | 50 | Operating Temperature Range °C** °F | -20° to 105° -4° to 221° |
| Insulation Withstanding Test Voltage (Volts AC/DC) | 2200 | Flammability Rating of Housing Material | UL94 V-0 |
| Contact Retention Force (lbf) | 500 | | |



* UL Rated for 65°C largest wire or cable size

** Contact factory for higher temperature rated connector

ORDERING INFORMATION

2 Pole Housing, 350 amp Contacts, & Auxiliary Contacts

| Part Number | Housing Color | Wire AWG | Wire sq. mm |
|-------------|---------------|----------|-------------|
| 6340G1 | Gray | 2/0 | 67.4 |
| 6340G2 | Gray | 3/0 | 85.0 |
| 6340G3 | Gray | 4/0 | 107.2 |
| 6340G5 | Gray | 300mcm | 152.0 |
| 6341G1 | Blue | 2/0 | 67.4 |
| 6341G2 | Blue | 3/0 | 85.0 |
| 6341G3 | Blue | 4/0 | 107.2 |
| 6341G5 | Blue | 300mcm | 152.0 |
| 6342G1 | Red | 2/0 | 67.4 |
| 6342G2 | Red | 3/0 | 85.0 |
| 6342G3 | Red | 4/0 | 107.2 |
| 6342G5 | Red | 300mcm | 152.0 |
| 6343G1 | Green | 2/0 | 67.4 |
| 6343G2 | Green | 3/0 | 85.0 |
| 6343G3 | Green | 4/0 | 107.2 |

2 pole housing, 350 amp contacts, & auxiliary contacts continued

| Part Number | Housing Color | Wire AWG | Wire sq. mm |
|-------------|---------------|----------|-------------|
| 6343G5 | Green | 300mcm | 152.0 |
| 6359G1 | Black | 2/0 | 67.4 |
| 6359G2 | Black | 3/0 | 85.0 |
| 6359G3 | Black | 4/0 | 107.2 |
| 6359G5 | Black | 300mcm | 152.0 |
| 6360G1 | Yellow | 2/0 | 67.4 |
| 6360G2 | Yellow | 3/0 | 85.0 |
| 6360G3 | Yellow | 4/0 | 107.2 |
| 6360G5 | Yellow | 300mcm | 152.0 |
| 6368G1 | Orange | 2/0 | 67.4 |
| 6368G2 | Orange | 3/0 | 85.0 |
| 6368G3 | Orange | 4/0 | 107.2 |
| 6368G5 | Orange | 300mcm | 152.0 |

2 Pole Housing & 350 amp Contacts

| Part Number | Housing Color | Wire AWG | Wire sq. mm |
|-------------|---------------|----------|-------------|
| 6345G1 | Gray | 2/0 | 67.4 |
| 6345G2 | Gray | 3/0 | 85.0 |
| 6345G3 | Gray | 4/0 | 107.2 |
| 6345G5 | Gray | 300mcm | 152.0 |
| 6346G1 | Blue | 2/0 | 67.4 |
| 6346G2 | Blue | 3/0 | 85.0 |
| 6346G3 | Blue | 4/0 | 107.2 |
| 6346G5 | Blue | 300mcm | 152.0 |
| 6347G1 | Red | 2/0 | 67.4 |
| 6347G2 | Red | 3/0 | 85.0 |
| 6347G3 | Red | 4/0 | 107.2 |
| 6347G5 | Red | 300mcm | 152.0 |
| 6348G1 | Green | 2/0 | 67.4 |
| 6348G2 | Green | 3/0 | 85.0 |
| 6348G3 | Green | 4/0 | 107.2 |
| 6348G5 | Green | 300mcm | 152.0 |

Note: For additional colors please contact customer service

HEADQUARTERS: 13 Pratts Junction Road, P.O. Box 579, Sterling, MA 01564 T:978-422-3600 F:978-422-3700

EUROPE: Rahealy Road, Fermoy Co. Cork, Ireland T:353-(0)25-32277 F:353-(0)25-32296

ASIA/PACIFIC: IDEAL Anderson Asia Pacific Ltd., Unit 922-928 Topsail Plaza, 11 On Sum Street, Shatin N.T., Hong Kong T:852-2636-0836 F:852-2635-9036

CHINA: IDEAL Anderson Technologies (Shenzhen) Ltd., Block A8 Tantou W. Ind. Par, Songgang Baoan District, Shenzhen, P.R. China 51810 T: 86-755-2768-2118 F: 86-755-2768-2218

TAIWAN: IDEAL Anderson Asia Pacific Ltd., Taiwan Branch, 4F-2, No.116, Dadun 20th St., Situn District, Taichung City 407, Taiwan (R.O.C.) T: 886-4-2310-6451 F:886-4-2310-6460

www.andersonpower.com

ORDERING INFORMATION

continued

2 Pole Housing & 350 amp Contacts

| Part Number | Housing Color | Wire | |
|-------------|---------------|--------|--------|
| | | AWG | sq. mm |
| 6363G2 | Black | 3/0 | 85.0 |
| 6363G3 | Black | 4/0 | 107.2 |
| 6363G5 | Black | 300mcm | 152.0 |
| 6364G1 | Yellow | 2/0 | 67.4 |
| 6364G2 | Yellow | 3/0 | 85.0 |
| 6364G3 | Yellow | 4/0 | 107.2 |
| 6364G5 | Yellow | 300mcm | 152.0 |
| 6369G1 | Orange | 2/0 | 67.4 |
| 6369G2 | Orange | 3/0 | 85.0 |
| 6369G3 | Orange | 4/0 | 107.2 |
| 6369G5 | Orange | 300mcm | 152.0 |

2 Pole Housing, 350 amp 35mm Contacts

| Part Number | Housing Color | Wire |
|-------------|---------------|--------|
| | | sq. mm |
| 6345G6 | Gray | 35 |
| 6346G6 | Blue | 35 |
| 6347G6 | Red | 35 |
| 6348G6 | Green | 35 |
| 6363G6 | Black | 35 |
| 6364G6 | Yellow | 35 |
| 6369G6 | Orange | 35 |

2 Pole Housing, 350 amp 35mm Contacts & Auxiliary Contacts

| Part Number | Housing Color | Wire |
|-------------|---------------|--------|
| | | sq. mm |
| 6340G6 | Gray | 35 |
| 6341G6 | Blue | 35 |
| 6342G6 | Red | 35 |
| 6343G6 | Green | 35 |
| 6359G6 | Black | 35 |
| 6360G6 | Yellow | 35 |
| 6380G6 | Orange | 35 |

Housings Only

| Part Number | Color |
|-------------|--------|
| 6350 | Gray |
| 6351 | Blue |
| 6352 | Red |
| 6353 | Green |
| 6361 | Black |
| 6362 | Yellow |
| 6339 | Orange |

Contacts

| Part Number | Description | Wire | |
|-------------|---------------------------|---------|--------|
| | | AWG | sq. mm |
| 6354 | Contact set (2) | 2/0 | 67.4 |
| 6355 | Contact set (2) | 3/0 | 85.0 |
| 6356 | Contact set (2) | 4/0 | 107.2 |
| 6358 | Contact set (2) | 300 mcm | 152.0 |
| 6394 | Contact set (2)-thin wall | N/A | 35 |

Bushings

| Part Number | Description | Wire | |
|-------------|-------------------|------------|--------------|
| | | AWG | sq. mm |
| 5918 | For use with 6354 | 2/0 to 1/0 | 67.4 to 53.5 |

Accessories

| Part Number | Description |
|-------------|--|
| 6305G1 | Auxiliary contact kit with contact part number 1331 |
| 6310G1 | Auxiliary contact kit with contact part number 1332 |
| 6337G1 | Charger key |
| 6367G1 | Pin kit #16/12(1.31/3.31mm)-for battery |
| 6366G2 | Charger key & socket |
| 995G2 | Handle with hardware "A" frame |
| 993G1 | Manual release-battery bracket with hardware |
| 994G1 | Manual release-charger/truck bracket with hardware |
| 911G2 | Cable clamps-use alone with manual release or "A" frame handle |

Tooling

| Part Number | Description |
|-------------|---|
| 970P1 | Extraction tool-insulated handle |
| 111038G2 | Contact insertion/extraction tool for auxiliary contact kit |
| 1368 | Hand tool for 1/0 to 95mm (53.5/95) |
| 1387G1 | Pneumatic tool |
| 1387G2 | Pneumatic tool |
| 1388G2 | - die for 2/0 & 3/0 (67.4/85.0) |
| 1388G9 | - die for 1/0 (53.5) |
| 1389G2 | - locator for 1/0 to 4/0 (53.5/107.2) |
| 1303G7 | - die for 70mm |
| 1303G8 | - die for 50mm |
| 1304G7 | - locator for 70mm |
| 1304G8 | - locator for 50mm |

TEMPERATURE RISE CHART

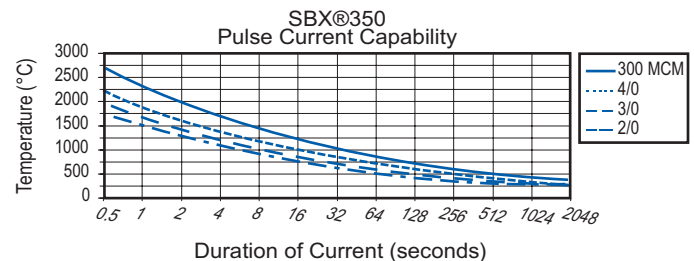
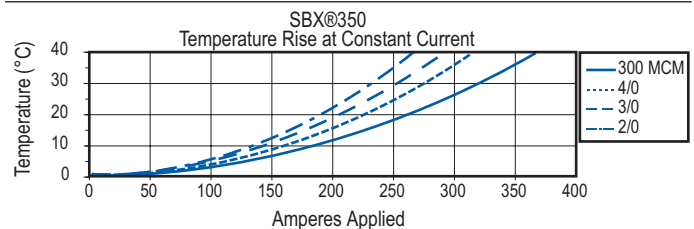

DIMENSIONS

Housing

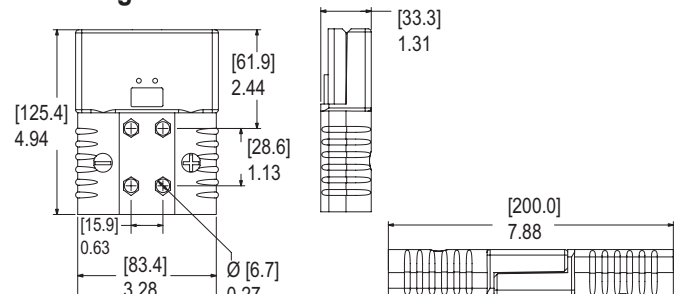

Recommended Voltage Key Color Code

| | | | | | | | | | | |
|----------------|--------|--------|-----|------|------|-------|-------|-------|--------|-------|
| Voltage | 12V | 18V | 24V | 36V | 48V | 72V | 80V | 96V | 120V | 144V |
| Color | Yellow | Orange | Red | Gray | Blue | Green | Black | Brown | Purple | White |

Products to be used in the U.S. must meet the requirements of the National Electric Code and applicable local codes, such as state codes. Testing to determine if a product conforms to the National Electric Code is performed by UL in their "LISTING" program.

UL current ratings of the Anderson Power Products connectors are references established when the connectors were accepted as recognized components by UL and do not constitute limits of suitability relative to conducted currents.

Connector devices are rated or derated by the wiring configuration and the environment. Factors to be considered are the wire enclosure characteristics, connector housing and wire insulation characteristics, the number of wires in an enclosed area such as raceway or conduit, as well as ambient temperatures.

The housing insulation temperature rating is specified by UL and is the limiting factor for determining suitability to an application. The housing insulation rating is the maximum temperature that can be applied to the housing which includes the temperature produced by conducting the maximum application current added to the maximum ambient temperature. The wire insulation temperature limits are also specified by UL and considered in like manner.

Suitability of an application should meet the following guidelines:

$$T^{\circ}(\text{amb}) + T^{\circ}(\text{@max. current}) \leq T^{\circ}(\text{conn. housing}) \text{ and } T^{\circ}(\text{wire insulation})$$

where:

- \leq = less than or equal to
- $T^{\circ}(\text{amb.})$ = ambient temperature
- $T^{\circ}(\text{@max. current})$ = temperature rise at application current
- $T^{\circ}(\text{conn. housing})$ = temperature rating of connector housing
- $T^{\circ}(\text{wire insulation})$ = temperature rating of wire insulation

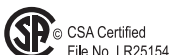

All Data Subject To Change Without Notice

HEADQUARTERS: 13 Pratts Junction Road, P.O. Box 579, Sterling, MA 01564 T:978-422-3600 F:978-422-3700

EUROPE: Rathealy Road, Fermoy Co. Cork, Ireland T:353-(0)25-32277 F:353-(0)25-32296

ASIA/PACIFIC: IDEAL Anderson Asia Pacific Ltd., Unit 922-928 Topsail Plaza, 11 On Sum Street, Shatin N.T., Hong Kong T:852-2636-0836 F:852-2635-9036

CHINA: IDEAL Anderson Technologies (Shenzhen) Ltd., Block A8 Tantou W. Ind. Par, Songgang Baoan District, Shenzhen, P.R. China 51810 T: 86-755-2768-2118 F: 86-755-2768-2218

TAIWAN: IDEAL Anderson Asia Pacific Ltd., Taiwan Branch, 4F.-2, No.116, Dadun 20th St., Situn District, Taichung City 407, Taiwan (R.O.C.) T: 886-4-2310-6451 F:886-4-2310-6460

www.andersonpower.com

TEMPERATURE RISE & PULSE CURRENT CHARTS

Temperature Rise Curves

A) Reading the Chart:

Temperature rise charts show the associated heat rise as a result of applied current to the connector. Heat rise is expressed as a $\Delta T^{\circ}\text{C}$.

$T_{\text{ambient}} - T_{\text{(maximum w/ applied current)}} = \Delta T$ The chart on the right shows the heat rise curve for the PP30 connector. Separate curves are shown for #16, #14 and #12 AWG wire. Interpreting the curves, if 17 amps is applied continuously to the connector, the heat rise will be 23°C for #16, 13°C for #14, and 9°C for #12 wire.

B) Ambients and Maximum Operating Temperature:

Connector devices are rated or derated by the wiring configuration and the environment. Factors to be considered are the wire enclosure characteristics, connector housing and wire insulation characteristics, the number of wires in an enclosed area such as a raceway, and the ambient operating temperatures.

The housing and wire insulation limits are specified by UL and are the limiting factor in determining the suitability of an application. The following guidelines should be met:

$T^{\circ}\text{C (ambient)} + \Delta T^{\circ}\text{C (at applied current)} < T^{\circ}\text{C (connector)}$ and $T^{\circ}\text{C (wire insulation)}$ where $T^{\circ}\text{C (connector)}$ = temperature limit of the connector housing and $T^{\circ}\text{C (wire insulation)}$ = the temperature limit of the wire insulation.

For example: A two pole PP30 connection with #14AWG wire operating at 17 amps with an ambient of 35°C. The temperature rise for the connection is 13°C. $35^{\circ}\text{C} + 13^{\circ}\text{C} = 48^{\circ}\text{C}$. The wire insulation is rated to 65°C, the connector housing is rated to a maximum temperature of 105°C. Both temperature limits are below 48°C, therefore, this application is suitable.

Pulse Current Curves

Pulse current curves show the highest instantaneous current that can be applied to a mated connection. Specifically, these curves show the time to produce a 30 °C temperature rise. These curves should be used as a guide in applications that have non-continuous/constant current.

The curve shown (on the right) is the pulse current curve for a multipole configuration of the SB50 connector. Interpreting the curves, if 120 amps is applied as a pulse current in an application, the maximum time that current can be applied will be 1s for #12, 2s for #10, 5s for #8 and 12s for #6 wire.

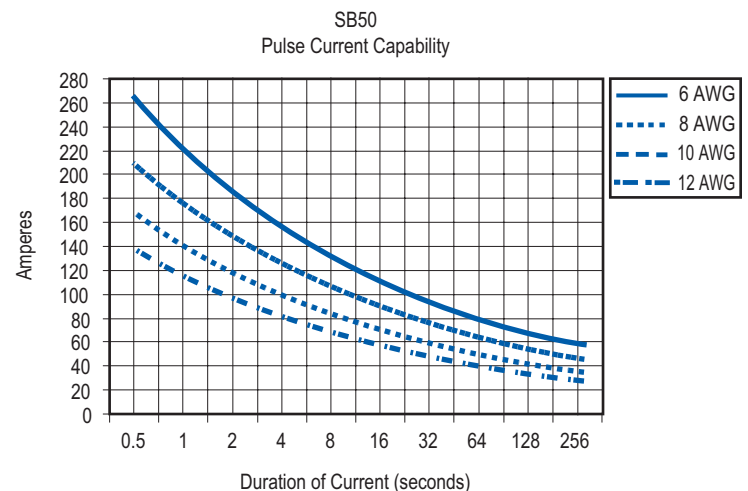
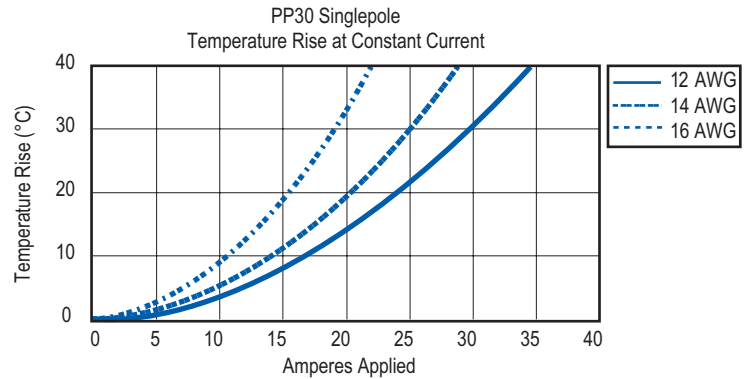

All Data Subject To Change Without Notice

HEADQUARTERS: 13 Pratts Junction Road, P.O. Box 579, Sterling, MA 01564 T:978-422-3600 F:978-422-3700

EUROPE: Rathealy Road, Fermoy Co. Cork, Ireland T:353-(0)25-32277 F:353-(0)25-32296

ASIA/PACIFIC: IDEAL Anderson Asia Pacific Ltd., Unit 922-928 Topsail Plaza, 11 On Sum Street, Shatin N.T., Hong Kong T:852-2636-0836 F:852-2635-9036

CHINA: IDEAL Anderson Technologies (Shenzhen) Ltd., Block A8 Tantou W. Ind. Par, Songgang Baoan District, Shenzhen, P.R. China 51810 T: 86-755-2768-2118 F: 86-755-2768-2218

TAIWAN: IDEAL Anderson Asia Pacific Ltd., Taiwan Branch, 4F.-2, No.116, Dadun 20th St., Situn District, Taichung City 407, Taiwan (R.O.C.) T: 886-4-2310-6451 F:886-4-2310-6460

www.andersonpower.com

CONVERSION CHART FOR AMERICAN WIRE GAUGE TO METRIC SYSTEM

| AWG Size | Metric mm ² | Circ. Mils | Equivalent Circ.Mils | Approximate Wire Diameter | |
|----------|------------------------|------------|----------------------|---------------------------|------|
| | | | | in. | mm |
| - | 0.5 | - | 937 | 0.032 | 0.81 |
| 20 | - | 1020 | - | 0.036 | 0.91 |
| - | 0.75 | - | 1480 | 0.039 | 0.99 |
| 18 | - | 1620 | - | 0.046 | 1.16 |
| - | 1 | - | 1974 | 0.051 | 1.30 |
| 16 | - | 2580 | - | 0.051 | 1.29 |
| - | 1.5 | - | 2960 | 0.063 | 1.60 |
| 14 | - | 4110 | - | 0.073 | 1.84 |
| - | 2.5 | - | 4934 | 0.081 | 2.06 |
| 12 | - | 6530 | - | 0.092 | 2.32 |
| - | 4 | - | 7894 | 0.102 | 2.59 |
| 10 | - | 10380 | - | 0.116 | 2.93 |
| - | 6 | - | 11840 | 0.126 | 3.21 |
| 8 | - | 16510 | - | 0.146 | 3.70 |
| - | 10 | - | 19740 | 0.162 | 4.12 |
| 6 | - | 26240 | - | 0.184 | 4.66 |
| - | 16 | - | 31580 | 0.204 | 5.18 |
| 4 | - | 41740 | - | 0.232 | 5.88 |
| - | 25 | - | 49340 | 0.260 | 6.60 |
| 2 | - | 66360 | - | 0.292 | 7.42 |
| - | 35 | - | 69070 | 0.305 | 7.75 |
| 1 | - | 83690 | - | 0.332 | 9.43 |
| - | 50 | - | 98680 | 0.365 | 9.27 |

| AWG Size | Metric mm ² | Circ. Mils | Equivalent Circ.Mils | Approximate Wire Diameter | |
|----------|------------------------|------------|----------------------|---------------------------|-------|
| | | | | in. | mm |
| 1/0 | - | 106mcm* | - | 0.373 | 9.46 |
| 2/0 | - | 133mcm* | - | 0.419 | 10.60 |
| - | 70 | - | 138.1mcm | 0.430 | 10.90 |
| 3/0 | - | 168mcm* | - | 0.471 | 12.00 |
| - | 95 | - | 187.5mcm | 0.504 | 12.80 |
| 4/0 | - | 212mcm* | - | 0.528 | 13.40 |
| - | 120 | - | 237.8mcm | 0.567 | 14.40 |
| - | - | 250mcm | - | 0.575 | 14.60 |
| - | 150 | 300mcm | - | 0.630 | 16.00 |
| - | - | 350mcm | - | 0.681 | 17.30 |
| - | 185 | - | 365.1mcm | 0.700 | 17.80 |
| - | - | 400mcm | - | 0.728 | 18.50 |
| - | 240 | - | 473.6mcm | 0.801 | 20.30 |
| - | - | 500mcm | - | 0.814 | 20.70 |
| - | 300 | - | 592.1mcm | 0.891 | 22.60 |
| - | - | 600mcm | - | 0.893 | 22.70 |
| - | - | 700mcm | - | 0.964 | 24.50 |
| - | - | 750mcm | - | 0.999 | 25.40 |
| - | 400 | - | 789.4mcm | 1.026 | 26.10 |
| - | - | 800mcm | - | 1.032 | 26.20 |
| - | 500 | - | 986.8mcm | 1.152 | 29.30 |
| - | - | 1000mcm | - | 1.153 | 29.30 |
| - | 625 | - | 1233.7mcm | 1.287 | 32.70 |

* Rounded for simplicity

All Data Subject To Change Without Notice

HEADQUARTERS: 13 Pratts Junction Road, P.O. Box 579, Sterling, MA 01564 T:978-422-3600 F:978-422-3700

EUROPE: Rathealy Road, Fermoy Co. Cork, Ireland T:353-(0)25-32277 F:353-(0)25-32296

ASIA/PACIFIC: IDEAL Anderson Asia Pacific Ltd., Unit 922-928 Topsail Plaza, 11 On Sum Street, Shatin N.T., Hong Kong T:852-2636-0836 F:852-2635-9036

CHINA: IDEAL Anderson Technologies (Shenzhen) Ltd., Block A8 Tantou W. Ind. Par, Songgang Baoan District, Shenzhen, P.R. China 51810 T: 86-755-2768-2118 F: 86-755-2768-2218

TAIWAN: IDEAL Anderson Asia Pacific Ltd., Taiwan Branch, 4F.-2, No.116, Dadun 20th St., Situn District, Taichung City 407, Taiwan (R.O.C.) T: 886-4-2310-6451 F:886-4-2310-6460

www.andersonpower.com

Applicator

A semi-automatic termination machine consisting of an upper and lower half that is used to crimp contacts onto wire. Used in conjunction with an electrical/mechanical press.

AWG

American Wire Gauge. A standard system for designating wire diameters.

Blindmate

To join two connector halves in a normal engaging mode without visual orientation.

Color Coding

A system of identification for terminals and related devices.

Contact Resistance

The electrical resistance of metallic surfaces at their interface in the contact area under specified conditions when carrying a specified test current.

Contact Retention

Minimum axial load in either direction which a contact must withstand while remaining firmly fixed in its normal position within a housing.

Crimp Retention

The axial load which a contact can withstand without separation from the wire.

Crimp Termination

A connection in which a metal sleeve is secured to a conductor by mechanically deforming the sleeve with presses or automated crimping machines, eliminating the need for solder. Suitable for all wire types.

Cycle Controlled

To determine if repetitive on/off conditions result in degrading the contact system which may lead to failures such as "thermal run away".

Detent

A bump or raised section projecting from the surface of a contact for keeping the contact in position relative to another and released by greater force.

Dielectric Strength (Withstanding Voltage)

The highest potential difference (voltage) that an insulation material of given thickness can withstand for a specified time without occurrence of electrical breakdown through its bulk.

Finger Proof

A connector intended for usage external to the end equipment shall have live parts protected against exposure to contact by persons when assembled, installed, and mated as intended, as determined by UL Articulated probe.

Flammability

The measure of a material's ability to support combustion. Often tested per UL94.

Flat Wiping

The sliding action which occurs when contacts are mated. Wiping has the effect of removing small amounts of contamination from the contact surfaces, thus establishing better conductivity.

Heat Rise

Temperature rise associated with the electrical load applied to a mated connection.

Hermaphroditic (Genderless) Connector

A connector in which both mating members are exactly alike at their mating face. There are no male or female members, but designs provide correct polarity.

Hot Plug

Live connector insertion/extractions in battery pack installations.

Insulation Resistance

Ratio of applied voltage to the total current between the two electrodes in contact with a specific insulation.

Glossary of Terminology

Locator

Device for positioning contacts into crimping dies.

Make First/Break Last (Sequencing)

Protective measure against excess currents, short-circuits, and ground faults by contacts used to interrupt the fault current flow before connector mating.

Mating Force

Force required to join two connector halves in a normal engaging mode.

Modular

Refers to similar parts or modules used as building blocks. A modular connector is one in which similar or identical sections can be assembled together to provide the appropriate connector type or size for the application.

Operating Temperature Range

Connector temperature rating established by materials used – plastic, finish, and the base metal. Applying an electrical load will result in a temperature rise that is additive to the operating ambient.

Polarization

A technique of eliminating symmetry so that parts may only be mated one way.

Pulse (Surge) Current

Highest instantaneous current that will run through a system.

Reducing Bushing

Separate tubular sleeve used to downsize the diameter of a crimp barrel to accept a smaller size wire.

Reeled Contacts

Contacts attached to a feeder strip for use in a high volume crimping tool.

Self-Wiping

The sliding action which occurs when contacts are mated. Wiping has the effect of removing small amounts of contamination from the contact surfaces, establishing better conductivity.

Spring Loaded

A means of providing contact normal force with the use of a mechanical spring.

Storage Battery

A voltaic battery consisting of two or more storage cells. Energy is accumulated by chemical activity in the charging process and released on demand in the form of electric current.

Strain Relief

A means of termination or installation that reduces the transfer of mechanical stress from the conductor.

Termination

Means of joining contacts to a conductor.

| PART NUMBER | PAGE | PART NUMBER | PAGE | PART NUMBER | PAGE |
|-------------|---|-------------|----------------------------|-------------|---|
| 10G56 | 26 | 1309G2 | 13, 15, 19, 41, 43, 71 | 1341G1 | 69 |
| 1109G9 | 41 | 1309G3 | 17, 41, 43 | 1341G2 | 69 |
| 110G10 | 41 | 1309G4 | 21, 23, 51, 55, 64, 74 | 1341G3 | 69 |
| 110G11 | 41 | 1309G5 | 13, 15, 17, 19, 41, 43 | 1345 | 16 |
| 110G12 | 12, 14, 16, 18 | 1317G1 | 30, 31, 42 | 1345G16 | 16 |
| 110G15 | 41 | 1317G11 | 30, 31, 42 | 1345G17 | 16 |
| 110G16 | 13, 15, 17, 18 | 1317G12 | 42 | 1345G18 | 16 |
| 110G17 | 13, 15, 17, 18 | 1317G13 | 30, 31, 42 | 1345G21 | 16 |
| 110G18 | 20, 26 | 1317G14 | 30, 31, 42 | 1345G22 | 16 |
| 110G19 | 20, 24 | 1317G15 | 30, 31, 42 | 1345G23 | 16 |
| 110G20 | 24, 26 | 1317G16 | 30, 31, 42 | 1345G5 | 16 |
| 110G21 | 12, 14, 16, 18 | 1317G17 | 30, 31, 42 | 1345G6 | 16 |
| 110G50 | 42 | 1317G18 | 30, 31, 42 | 1345G7 | 16 |
| 110G51 | 42 | 1317G2 | 30, 31, 42 | 1345G8 | 16 |
| 110G54 | 46 | 1317G3 | 30, 31, 42 | 1347 | 26, 27, 58 |
| 110G55 | 46 | 1317G4 | 30, 31, 42 | 1348 | 26, 27, 58 |
| 110G56 | 59 | 1319 | 24, 25 | 134G1 | 54 |
| 110G57 | 20, 22, 55, 56 | 1319G4 | 24, 25 | 134G2 | 59 |
| 110G68 | 12, 14, 16, 30, 32 | 1319G6 | 24, 25 | 134G3 | 61 |
| 110G73 | 46 | 1320 | 24 | 134G4 | 56 |
| 111038G2 | 13, 15, 17, 19, 41, 43, 67, 69, 79, 81 | 1320G1 | 24 | 1367G1 | 71 |
| 111197G1 | 59, 61 | 1320G2 | 24 | 1368 | 24, 26, 56, 59, 61, 67, 69, 79, 81 |
| 114555P1 | 30, 31, 32, 33 | 1320G3 | 24 | 1377G1 | 30, 31, 42 |
| 114555P2 | 30, 31, 32, 33 | 1320G4 | 24 | 1377G11 | 30, 31, 42 |
| 114555P3 | 30, 31, 32, 33 | 1321 | 24 | 1377G12 | 30, 31, 42 |
| 114555P5 | 30, 31, 32, 33 | 1321G1 | 24 | 1377G13 | 30, 31, 42 |
| 114555P6 | 30, 31, 32, 33 | 1321G2 | 24 | 1377G14 | 30, 31, 42 |
| 114555P7 | 30, 31, 32, 33 | 1321G3 | 24 | 1377G15 | 30, 31, 42 |
| 114555P8 | 30, 31, 32, 33 | 1321G4 | 24 | 1377G16 | 30, 31, 42 |
| 114555P9 | 30, 31, 32, 33 | 1327 | 12, 14, 16, 30, 32, 42, 71 | 1377G17 | 30, 31, 42 |
| 115G1 | 41 | 1327FP | 18 | 1377G18 | 30, 31, 42 |
| 115G2 | 41 | 1327G16 | 12, 14, 16, 30, 32, 42, 71 | 1377G2 | 30, 31, 42 |
| 115G3 | 41 | 1327G17 | 12, 14, 16, 30, 32, 42, 71 | 1377G3 | 30, 31, 42 |
| 115G4 | 41 | 1327G18 | 12, 14, 16, 30, 32, 42, 71 | 1377G4 | 30, 31, 42 |
| 1200G1 | 6 | 1327G18 | 42 | 1380 | 26 |
| 1201G1 | 6 | 1327G21 | 12, 14, 16, 30, 32, 42, 71 | 1380G1 | 26 |
| 1202G1 | 6 | 1327G22 | 12, 14, 16, 30, 32, 42, 71 | 1380G2 | 26 |
| 1203G1 | 6 | 1327G23 | 12, 14, 16, 30, 32, 42, 71 | 1380G3 | 26 |
| 1204G1 | 6 | 1327G5 | 12, 14, 16, 30, 32, 42, 71 | 1380G4 | 26 |
| 1205G1 | 6 | 1327G5FP | 18 | 1381 | 26, 46 |
| 120BBS | 46, 47, 56, 57 | 1327G6 | 12, 14, 16, 30, 32, 42, 71 | 1381G1 | 26, 46 |
| 1226G1 | 8 | 1327G6FP | 18 | 1381G2 | 26, 46 |
| 1228G1 | 8 | 1327G7 | 12, 14, 16, 30, 32, 42, 71 | 1381G3 | 26, 46 |
| 1230G1 | 8, 42 | 1327G7FP | 18 | 1381G4 | 26, 46 |
| 1231G1 | 8 | 1327G8 | 12, 14, 16, 30, 32, 42, 71 | 1382 | 26, 27, 58 |
| 1232G1 | 8, 42 | 1327G8FP | 18 | 1383 | 26, 27, 58 |
| 1233G1 | 8 | 1330 | 14 | 1384 | 26, 27, 58 |
| 1234G1 | 8 | 1330G11 | 14 | 1387G1 | 8, 21, 23, 24, 26, 41, 43, 51, 55, 56, 59, 61, 64, 67, 69, 74, 79, 81 |
| 1235G1 | 8 | 1330G12 | 14 | 1387G2 | 61, 67, 69, 79, 81 |
| 1300 | 20 | 1330G13 | 14 | 1388G1 | 61 |
| 1300G2 | 20 | 1330G14 | 14 | 1388G2 | 61, 69, 81 |
| 1300G3 | 20 | 1330G15 | 14 | 1388G3 | 26, 59, 67, 79 |
| 1300G4 | 20 | 1330G16 | 14 | 1388G4 | 24, 56 |
| 1300G5 | 20 | 1330G17 | 14 | 1388G5 | 26, 59 |
| 1303G3 | 61 | 1330G2 | 14 | 1388G6 | 21, 23, 51, 55, 64, 74 |
| 1303G4 | 59, 67, 79 | 1330G4 | 14 | 1388G7 | 21, 23, 51, 55 |
| 1303G7 | 69, 81 | 1330G5 | 14 | 1388G8 | 8, 41, 43 |
| 1303G8 | 69, 81 | 1331 | 14, 15, 19, 42, 71 | 1388G9 | 69, 81 |
| 1304G4 | 59, 67, 79 | 1332 | 12, 13, 18, 19, 42, 71 | 1389G1 | 61 |
| 1304G7 | 69, 81 | 1335G1 | 32 | 1389G2 | 61, 69, 81 |
| 1304G8 | 69, 81 | 1336G1 | 32 | 1389G3 | 26, 59, 67, 79 |
| 1304G9 | 61 | 1337G1 | 32 | 1389G4 | 24, 56 |
| 1307 | 20, 21, 22, 23, 54, 55 | 1339G1 | 64, 74 | | |
| 1309G1 | 6, 41 | 1339G2 | 50 | | |
| | | 1339G3 | 50 | | |

HEADQUARTERS: 13 Pratts Junction Road, P.O. Box 579, Sterling, MA 01564 T:978-422-3600 F:978-422-3700

EUROPE: Rathealy Road, Fermoy Co. Cork, Ireland T:353-(0)25-32277 F:353-(0)25-32296

ASIA/PACIFIC: IDEAL Anderson Asia Pacific Ltd., Unit 922-928 Topsail Plaza, 11 On Sum Street, Shatin N.T., Hong Kong T:852-2636-0836 F:852-2635-9036

CHINA: IDEAL Anderson Technologies (Shenzhen) Ltd., Block A8 Tantou W. Ind. Par, Songgang Baoan District, Shenzhen, P.R. China 51810 T: 86-755-2768-2218 F: 86-755-2768-2218

TAIWAN: IDEAL Anderson Asia Pacific Ltd., Taiwan Branch, 4F-2, No.116, Dadun 20th St., Situn District, Taichung City 407, Taiwan (R.O.C.) T: 886-4-2310-6451 F:886-4-2310-6460

www.andersonpower.com

| PART NUMBER | PAGE | PART NUMBER | PAGE | PART NUMBER | PAGE |
|-------------|----------------------------|-------------|---------------------------|-------------|----------------|
| 1389G5 | 26, 59 | 180BBS | 26, 27, 46, 47, 58, 59 | 6305G1 | 69, 81 |
| 1389G6 | 21, 23, 55 | 200G1L | 16, 17, 18, 19 | 6310G1 | 69, 81 |
| 1389G7 | 21, 23, 55 | 200G2L | 12, 13, 14, 15, 18, 19 | 6316 | 58 |
| 1389G8 | 8, 41, 43 | 201G1H | 16, 17, 18, 19 | 6316G10 | 58 |
| 1389G9 | 51, 64, 74 | 201G2H | 12, 13, 14, 15, 18, 19 | 6316G9 | 58 |
| 1395 | 12 | 250G1 | 6, 13, 15, 17, 19, 41, 43 | 6319 | 54 |
| 1395G1 | 12 | 250G2 | 6, 13, 15, 17, 19, 41, 43 | 6319G1 | 54 |
| 1395G10 | 12 | 250G4 | 41 | 6320G1 | 60 |
| 1395G2 | 12 | 250G5 | 21, 23 | 6320G2 | 60 |
| 1395G3 | 12 | 260G1 | 13, 15, 17, 19, 43 | 6320G4 | 60 |
| 1395G4 | 12 | 260G14 | 13, 15, 17, 19, 41, 43 | 6320G5 | 60 |
| 1395G5 | 12 | 260G15 | 13, 15, 17, 19, 41, 43 | 6321G1 | 60 |
| 1395G6 | 12 | 260G16 | 21, 23, 55 | 6321G2 | 60 |
| 1395G7 | 12 | 260G18 | 13, 15, 17, 19, 41, 43 | 6321G4 | 60 |
| 1395G8 | 12 | 260G3 | 6, 41 | 6321G5 | 60 |
| 1395G9 | 12 | 261G1 | 14, 15, 18, 19, 42 | 6322G1 | 60 |
| 1396G1 | 8, 41, 43 | 261G2 | 16, 17, 18, 19, 42 | 6322G2 | 60 |
| 1399G1 | 13, 15, 16, 17, 18, 30, 32 | 261G2-LPBK | 16, 17, 18, 19, 42 | 6322G4 | 60 |
| 1399G2 | 13, 15, 16, 17, 18, 30, 32 | 262G1 | 12, 13, 18, 19, 42 | 6322G5 | 60 |
| 1399G20 | 20 | 263G1 | 6 | 6323G1 | 60 |
| 1399G6 | 13, 15, 16, 17, 18, 30, 32 | 264G1 | 6 | 6323G2 | 60 |
| 1399G7 | 20 | 265G1 | 20, 21, 22, 23, 54, 55 | 6323G4 | 60 |
| 1399G8 | 12, 14, 16, 17, 18, 30, 32 | 265G2 | 20, 21, 22, 23, 54, 55 | 6323G5 | 60 |
| 1399G9 | 12, 14, 16, 17, 18, 30, 32 | 265G3 | 20, 21, 22, 23, 54, 55 | 6324G1 | 60 |
| 1399H6 | 71 | 265G4 | 20, 21, 22, 23, 54, 55 | 6324G2 | 60 |
| 1441G1 | 12, 14, 16, 18 | 265G5 | 20, 21, 22, 23, 54, 55 | 6324G4 | 60 |
| 1442G1 | 12, 14, 16, 18 | 265G6 | 20, 21, 22, 23, 54, 55 | 6324G5 | 60 |
| 1450G1 | 40 | 265G7 | 20, 21, 22, 23, 54, 55 | 6325G1 | 58 |
| 1450G2 | 40 | 265G8 | 20, 21, 22, 23, 54, 55 | 6325G5 | 58 |
| 1450G3 | 40 | 269G1 | 14, 15, 18, 19 | 6325G6 | 58 |
| 1451G2 | 40 | 269G1-LPBK | 14, 15, 18, 19 | 6326G1 | 58 |
| 1451G6 | 40 | 269G2 | 12, 13, 18, 19 | 6326G5 | 58 |
| 1452G1 | 40 | 269G2-LPBK | 12, 13, 18, 19 | 6326G6 | 58 |
| 1452G2 | 40 | 269G3 | 16, 17, 18, 19 | 6327G1 | 58 |
| 1452G3 | 40 | 2-7252G11 | 58 | 6327G5 | 58 |
| 1453G1 | 40 | 280G1 | 13, 15, 17, 19, 41, 43 | 6327G6 | 58 |
| 1453G2 | 40 | 280G2 | 6, 41 | 6328G1 | 58 |
| 1453G3 | 40 | 280G4 | 13, 15, 17, 19, 43 | 6328G5 | 58 |
| 1454G1 | 40 | 284G1 | 21, 23 | 6328G6 | 58 |
| 1454G2 | 40 | 350BBS | 46, 47, 60, 61 | 6329G1 | 58 |
| 1454G3 | 40 | 5648 | 26, 59, 67, 69, 79 | 6329G5 | 58 |
| 1460G1 | 40 | 5663 | 26, 59, 67, 69, 79 | 6329G6 | 58 |
| 1460G2 | 40 | 5687 | 26, 59, 67, 69, 79 | 6331G1 | 54 |
| 1460G3 | 40 | 5690 | 26, 59, 67, 69, 79 | 6331G10 | 54 |
| 1460G4 | 40 | 5693 | 26, 59, 67, 69, 79 | 6331G11 | 54 |
| 1461G1 | 40 | 5900 | 20, 21, 22, 23, 54, 55 | 6331G12 | 54 |
| 1461G2 | 40 | 5905 | 50, 55 | 6331G2 | 54 |
| 1461G3 | 40 | 5910 | 20, 22, 50, 55, 64, 74 | 6331G3 | 54 |
| 1462G1 | 13, 15, 16, 17, 18 | 5912 | 20, 22, 50, 55, 64, 74 | 6331G4 | 54 |
| 1462G2 | 13, 15, 17, 18 | 5913 | 20, 22, 50, 55 | 6331G5 | 54 |
| 1462G3 | 13, 15, 17, 18 | 5914 | 20, 21, 22, 23, 54, 55 | 6331G6 | 54 |
| 1463G1 | 20, 21, 22 | 5915 | 20, 21, 22, 23, 54, 55 | 6331G7 | 54 |
| 1463G2 | 20, 21, 22 | 5916 | 20, 46 | 6331G8 | 54 |
| 1464G1 | 25 | 5916G4 | 20, 46 | 6331G9 | 54 |
| 1464G2 | 25 | 5916G5 | 20, 46 | 6337G1 | 66, 69, 79, 81 |
| 1465G1 | 26, 27 | 5916G6 | 20, 46 | 6339 | 81 |
| 1465G2 | 26, 27 | 5916G7 | 20, 46 | 6340G1 | 80 |
| 1466G1 | 50 | 5918 | 61, 69, 81 | 6340G2 | 80 |
| 1467G1 | 56 | 5919 | 24, 25, 56 | 6340G3 | 80 |
| 1470G1 | 40 | 5920 | 24, 25, 56, 67, 69, 79 | 6340G5 | 80 |
| 1470G2 | 40 | 5921 | 24, 25, 56 | 6340G6 | 81 |
| 1470G3 | 40 | 5952 | 20, 21, 22, 23, 54, 55 | 6341G1 | 80 |
| 1470G4 | 40 | 5953 | 20, 21, 22, 23, 54, 55 | 6341G2 | 80 |
| 160G1 | 41 | 5954 | 71 | 6341G3 | 80 |
| 1703G1 | 71 | 6170G1 | 71 | 6341G5 | 80 |

HEADQUARTERS: 13 Pratts Junction Road, P.O. Box 579, Sterling, MA 01564 T:978-422-3600 F:978-422-3700

EUROPE: Rathealy Road, Fermoy Co. Cork, Ireland T:353-(0)25-32277 F:353-(0)25-32296

ASIA/PACIFIC: IDEAL Anderson Asia Pacific Ltd., Unit 922-928 Topsail Plaza, 11 On Sum Street, Shatin N.T., Hong Kong T:852-2636-0836 F:852-2635-9036

CHINA: IDEAL Anderson Technologies (Shenzhen) Ltd., Block A8 Tantou W. Ind. Par. Songgang Baoan District, Shenzhen, P.R. China 51810 T: 86-755-2768-2218 F: 86-755-2768-2218

TAIWAN: IDEAL Anderson Asia Pacific Ltd., Taiwan Branch, 4F-2, No.116, Dadun 20th St., Situn District, Taichung City 407, Taiwan (R.O.C.) T: 886-4-2310-6451 F:886-4-2310-6460

www.andersonpower.com

| PART NUMBER | PAGE | PART NUMBER | PAGE | PART NUMBER | PAGE |
|-------------|----------------|-------------|--------|---------------|--------------------------------|
| 6341G6 | 81 | 6368G3 | 80 | 6811G3 | 56, 57 |
| 6342G1 | 80 | 6368G5 | 80 | 700G1 | 71 |
| 6342G2 | 80 | 6369G1 | 81 | 702G1 | 71 |
| 6342G3 | 80 | 6369G2 | 81 | 704G1 | 71 |
| 6342G5 | 80 | 6369G3 | 81 | 705G1 | 71 |
| 6342G6 | 81 | 6369G5 | 81 | 706G1 | 71 |
| 6343G1 | 80 | 6369G6 | 81 | 707G1 | 71 |
| 6343G2 | 80 | 6370G1 | 78 | 708G1 | 71 |
| 6343G3 | 80 | 6370G2 | 78 | 709G1 | 71 |
| 6343G5 | 80 | 6371G1 | 78 | 710G1 | 71 |
| 6343G6 | 81 | 6371G2 | 78 | 75 LOKSMTBLU | 22 |
| 6344 | 64, 66, 74, 79 | 6372G1 | 78 | 75BBS | 20, 21, 22, 23, 46, 47, 54, 55 |
| 6345G1 | 80 | 6372G2 | 78 | 75LOK45BLU | 22 |
| 6345G2 | 80 | 6373G1 | 78 | 75LOK90BLU | 22 |
| 6345G3 | 80 | 6373G2 | 78 | 75LOKBLK | 22 |
| 6345G5 | 80 | 6374G1 | 78 | 75LOKBLU | 22 |
| 6345G6 | 81 | 6374G2 | 78 | 75LOKGRA | 22 |
| 6346G1 | 80 | 6375G1 | 78 | 75LOKGRN | 22 |
| 6346G2 | 80 | 6375G2 | 78 | 75LOKWHT | 22 |
| 6346G3 | 80 | 6376G1 | 78 | 75LOKWNGBLU | 22 |
| 6346G5 | 80 | 6376G2 | 78 | 75LOKWNGBLU-R | 22 |
| 6346G6 | 81 | 6377G1 | 78 | 75LOKYEL | 22 |
| 6347G1 | 80 | 6377G2 | 78 | 902 | 58 |
| 6347G2 | 80 | 6378G1 | 78 | 903G1 | 20, 21, 22, 23, 54, 55 |
| 6347G3 | 80 | 6378G2 | 78 | 904G1 | 20, 21, 22, 23, 54, 55 |
| 6347G5 | 80 | 6379G1 | 78 | 906 | 46, 60 |
| 6347G6 | 81 | 6379G2 | 78 | 907 | 60, 61 |
| 6348G1 | 80 | 6380G1 | 78 | 908 | 60, 61 |
| 6348G2 | 80 | 6380G6 | 81 | 910 | 60, 61 |
| 6348G3 | 80 | 6381G1 | 78 | 911 | 61 |
| 6348G5 | 80 | 6382G1 | 78 | 911G2 | 69, 81 |
| 6348G6 | 81 | 6383G1 | 78 | 912 | 46, 60 |
| 6350 | 81 | 6384G1 | 66 | 913 | 46, 60 |
| 6351 | 81 | 6384G1 | 67 | 914 | 46, 60 |
| 6352 | 81 | 6384G1 | 78 | 916 | 60, 61 |
| 6353 | 81 | 6384G1 | 79 | 917 | 60, 61 |
| 6354 | 69, 81 | 6384G2 | 66 | 919 | 61 |
| 6355 | 69, 81 | 6384G2 | 67 | 919G1 | 61 |
| 6356 | 69, 81 | 6384G2 | 78 | 922G1 | 61 |
| 6358 | 81 | 6384G2 | 79 | 923 | 59 |
| 6359G1 | 80 | 6385G1 | 78 | 924 | 59 |
| 6359G2 | 80 | 6387G1 | 78 | 931 | 46, 60 |
| 6359G3 | 80 | 6387G2 | 78 | 932 | 46, 60 |
| 6359G5 | 80 | 6390G1 | 78 | 940 | 46, 58 |
| 6359G6 | 81 | 6391G1 | 78 | 941 | 46, 58 |
| 6360G1 | 80 | 6391G2 | 78 | 942 | 46, 58 |
| 6360G2 | 80 | 6394 | 69, 81 | 943 | 46, 58 |
| 6360G3 | 80 | 6400G1 | 60 | 944 | 58, 59 |
| 6360G5 | 80 | 6400G2 | 60 | 944G1 | 58, 59 |
| 6360G6 | 81 | 6400G4 | 60 | 945 | 59 |
| 6361 | 81 | 6400G5 | 60 | 945G2 | 66, 79 |
| 6362 | 81 | 6800G1 | 56 | 945G3 | 59 |
| 6363G2 | 81 | 6800G2 | 56 | 946G1 | 59 |
| 6363G3 | 81 | 6800G3 | 56 | 947 | 58, 59 |
| 6363G5 | 81 | 6801G1 | 56 | 948 | 58, 59 |
| 6363G6 | 81 | 6801G2 | 56 | 948G1 | 58, 59 |
| 6364G1 | 81 | 6801G3 | 56 | 949 | 46, 58 |
| 6364G2 | 81 | 6802G1 | 56 | 969P1 | 67, 79 |
| 6364G3 | 81 | 6802G2 | 56 | 970P1 | 69, 81 |
| 6364G5 | 81 | 6802G3 | 56 | 981G1 | 56 |
| 6364G6 | 81 | 6810G1 | 46, 56 | 981G2 | 56 |
| 6366G2 | 66, 69, 79, 81 | 6810G2 | 46, 56 | 990 | 50, 54 |
| 6367G1 | 69, 79, 81 | 6810G3 | 46, 56 | 990G1 | 50, 55 |
| 6368G1 | 80 | 6811G1 | 56, 57 | 990G2 | 54 |
| 6368G2 | 80 | 6811G2 | 56, 57 | 992 | 46, 54 |

HEADQUARTERS: 13 Pratts Junction Road, P.O. Box 579, Sterling, MA 01564 T:978-422-3600 F:978-422-3700

EUROPE: Rathealy Road, Fermoy Co. Cork, Ireland T:353-(0)25-32277 F:353-(0)25-32296

ASIA/PACIFIC: IDEAL Anderson Asia Pacific Ltd., Unit 922-928 Topsail Plaza, 11 On Sum Street, Shatin N.T., Hong Kong T:852-2636-0836 F:852-2635-9036

CHINA: IDEAL Anderson Technologies (Shenzhen) Ltd., Block A8 Tantou W. Ind. Par, Songgang Baoan District, Shenzhen, PR. China 51810 T: 86-755-2768-2118 F: 86-755-2768-2218

TAIWAN: IDEAL Anderson Asia Pacific Ltd., Taiwan Branch, 4F.-2, No.116, Dadun 20th St., Situn District, Taichung City 407, Taiwan (R.O.C.) T: 886-4-2310-6451 F:886-4-2310-6460

www.andersonpower.com

| PART NUMBER | PAGE | PART NUMBER | PAGE | PART NUMBER | PAGE |
|-------------|------------|---------------|-------|-----------------|------|
| 992G1 | 46, 54 | E6360G1 | 68 | SB350-LOCKOUT | 61 |
| 992G2 | 46, 54 | E6360G2 | 68 | SB50-HDL-RED | 54 |
| 992G4 | 46, 54 | E6360G6 | 68 | SBE80CLPRED | 64 |
| 992G5 | 46, 54 | E6361 | 69 | SBE80HDLRED | 64 |
| 992G6 | 46, 54 | E6362 | 69 | SBE80ORN | 64 |
| 992G7 | 46, 54 | E6363G1 | 68 | SBE80RED | 64 |
| 993G1 | 69, 81 | E6363G2 | 68 | SBE80RED16MMHDL | 64 |
| 993G2 | 66, 79 | E6363G6 | 68 | SBE80WHT | 64 |
| 994G1 | 69, 81 | E6364G1 | 68 | SBE80YEL | 64 |
| 994G2 | 66, 79 | E6364G2 | 68 | SBO60CLPRED | 74 |
| 995G1 | 59, 66, 79 | E6364G6 | 68 | SBO60HDLRED | 74 |
| 995G2 | 61, 69, 81 | E6368G1 | 68 | SBO60ORN | 74 |
| 995G3 | 59 | E6368G2 | 68 | SBO60ORN16MMHDL | 74 |
| 995G4 | 61 | E6368G6 | 68 | SBO60RED | 74 |
| 996G1 | 61 | E6369G1 | 68 | SBO60RED16MMHDL | 74 |
| BMHSG-P | 42 | E6369G2 | 68 | SBO60WHT | 74 |
| BMHSG-R | 42 | E6369G6 | 68 | SBO60WHT16MMHDL | 74 |
| BMPP10-45P | 42 | E6370G2 | 66 | SBO60YEL | 74 |
| BMPP10-45R | 42 | E6371G2 | 66 | SBO60YEL16MMHDL | 74 |
| E6332G1 | 68 | E6372G2 | 66 | SBS50BLK | 50 |
| E6332G2 | 68 | E6373G2 | 66 | SBS50BLK #10/12 | 50 |
| E6332G6 | 68 | E6374G2 | 66 | SBS50BLK #6 | 50 |
| E6333G1 | 68 | E6375G2 | 66 | SBS50BLU | 50 |
| E6333G2 | 68 | E6376G2 | 66 | SBS50BLU#10/12 | 50 |
| E6333G6 | 68 | E6377G2 | 66 | SBS50BLU#6 | 50 |
| E6334G1 | 68 | E6378G2 | 66 | SBS50BRN | 50 |
| E6334G2 | 68 | E6379G2 | 66 | SBS50BRN#10/12 | 50 |
| E6334G6 | 68 | E6380G1 | 66 | SBS50BRN#6 | 50 |
| E6335G1 | 68 | E6381G1 | 66 | SBS50GRA | 50 |
| E6335G2 | 68 | E6382G1 | 66 | SBS50GRA#10/12 | 50 |
| E6335G6 | 68 | E6383G1 | 66 | SBS50GRA#6 | 50 |
| E6336 | 69 | E6385G1 | 66 | SBS50-HDL-Red | 50 |
| E6339 | 69 | E6387G2 | 66 | SBS50RED | 50 |
| E6340G1 | 68 | E6388G2 | 66 | SBS50RED #10/12 | 50 |
| E6340G2 | 68 | E6389G2 | 66 | SBS50RED #6 | 50 |
| E6340G6 | 68 | E6390G1 | 66 | SBS50WHT | 50 |
| E6341G1 | 68 | E6391G2 | 66 | SBS50WHT#10/12 | 50 |
| E6341G2 | 68 | E6392G1 | 66 | SBS50WHT#6 | 50 |
| E6341G6 | 68 | PC5930S | 35 | U34RT | 71 |
| E6342G1 | 68 | PC5930T | 35 | Y750 | 71 |
| E6342G2 | 68 | PC5933S | 35 | | |
| E6342G6 | 68 | PC5933T | 35 | | |
| E6343G1 | 68 | PC5934S | 35 | | |
| E6343G2 | 68 | PC5934T | 35 | | |
| E6343G6 | 68 | PC-HSG-PP | 35 | | |
| E6345G1 | 68 | PC-HSG-SB | 35 | | |
| E6345G2 | 68 | PCSTAPLE-1 | 36 | | |
| E6345G6 | 68 | PCSTAPLE-2 | 36 | | |
| E6346G1 | 68 | PP30GND-P | 8, 42 | | |
| E6346G2 | 68 | PP30GND-S | 8, 42 | | |
| E6346G6 | 68 | PP30MF-P10S | 8 | | |
| E6347G1 | 68 | PP30MF-P10T | 8 | | |
| E6347G2 | 68 | PP30MF-PPCS | 8 | | |
| E6347G6 | 68 | PP30MF-PPCT | 8 | | |
| E6348G1 | 68 | PP30MF-S10S | 8 | | |
| E6348G2 | 68 | PP30MF-S10T | 8 | | |
| E6348G6 | 68 | PP45PC12R | 32 | | |
| E6349 | 69 | PP45PC12S | 32 | | |
| E6350 | 69 | PP45PC13R | 32 | | |
| E6351 | 69 | PP45PC13S | 32 | | |
| E6352 | 69 | PP45PC21R | 32 | | |
| E6353 | 69 | PP45PC22R | 32 | | |
| E6359G1 | 68 | PP45PC23R | 32 | | |
| E6359G2 | 68 | SB120-HDL-RED | 56 | | |
| E6359G6 | 68 | SB175-LOCKOUT | 59 | | |

HEADQUARTERS: 13 Pratts Junction Road, P.O. Box 579, Sterling, MA 01564 T:978-422-3600 F:978-422-3700

EUROPE: Rathealy Road, Fermoy Co. Cork, Ireland T:353-(0)25-32277 F:353-(0)25-32296

ASIA/PACIFIC: IDEAL Anderson Asia Pacific Ltd., Unit 922-928 Topsail Plaza, 11 On Sum Street, Shatin N.T., Hong Kong T:852-2636-0836 F:852-2635-9036

CHINA: IDEAL Anderson Technologies (Shenzhen) Ltd., Block A8 Tantou W. Ind. Par. Songgang Baoan District, Shenzhen, PR. China 51810 T: 86-755-2768-2118 F: 86-755-2768-2218

TAIWAN: IDEAL Anderson Asia Pacific Ltd., Taiwan Branch, 4F-2, No.116, Dadun 20th St., Situn District, Taichung City 407, Taiwan (R.O.C.) T: 886-4-2310-6451 F:886-4-2310-6460

www.andersonpower.com



Connector Notes

For customer drawings, assembly instructions and individual data sheets, please visit www.andersonpower.com

HEADQUARTERS: 13 Pratts Junction Road, P.O. Box 579, Sterling, MA 01564 T:978-422-3600 F:978-422-3700

EUROPE: Rathealy Road, Fermoy Co. Cork, Ireland T:353-(0)25-32277 F:353-(0)25-32296

ASIA/PACIFIC: IDEAL Anderson Asia Pacific Ltd., Unit 922-928 Topsail Plaza, 11 On Sum Street, Shatin N.T., Hong Kong T:852-2636-0836 F:852-2635-9036

CHINA: IDEAL Anderson Technologies (Shenzhen) Ltd., Block A8 Tantou W. Ind. Par, Songgang Baoan District, Shenzhen, P.R. China 51810 T: 86-755-2768-2118 F: 86-755-2768-2218

TAIWAN: IDEAL Anderson Asia Pacific Ltd., Taiwan Branch, 4F.-2, No.116, Dadun 20th St., Situn District, Taichung City 407, Taiwan (R.O.C.) T: 886-4-2310-6451 F:886-4-2310-6460

www.andersonpower.com



Connector Notes

For customer drawings, assembly instructions and individual data sheets, please visit www.andersonpower.com.

HEADQUARTERS: 13 Pratts Junction Road, P.O. Box 579, Sterling, MA 01564 T:978-422-3600 F:978-422-3700

EUROPE: Rathealy Road, Fermoy Co. Cork, Ireland T:353-(0)25-32277 F:353-(0)25-32296

ASIA/PACIFIC: IDEAL Anderson Asia Pacific Ltd., Unit 922-928 Topsail Plaza, 11 On Sum Street, Shatin N.T., Hong Kong T:852-2636-0836 F:852-2635-9036

CHINA: IDEAL Anderson Technologies (Shenzhen) Ltd., Block A8 Tantou W. Ind. Par, Songgang Baoan District, Shenzhen, P.R. China 51810 T: 86-755-2768-2118 F: 86-755-2768-2218

TAIWAN: IDEAL Anderson Asia Pacific Ltd., Taiwan Branch, 4F.-2, No.116, Dadun 20th St., Situn District, Taichung City 407, Taiwan (R.O.C.) T: 886-4-2310-6451 F:886-4-2310-6460

www.andersonpower.com



For information on additional product lines, please contact your local APP customer service department.



PowerMod® HP Connectors



PowerMod® Connectors



Power Drawer® Connectors



Power Clip®



ACARA® Filter Connector



EBC / DIN Connectors

HEADQUARTERS: 13 Pratts Junction Road, P.O. Box 579, Sterling, MA 01564 T:978-422-3600 F:978-422-3700

EUROPE: Rathely Road, Fermoy Co. Cork, Ireland T:353-(0)25-32277 F:353-(0)25-32296

ASIA/PACIFIC: IDEAL Anderson Asia Pacific Ltd., Unit 922-928 Topsail Plaza, 11 On Sum Street, Sha Tin N.T., Hong Kong T:852-2636-0836 F:852-2635-9036

CHINA: IDEAL Anderson Technologies (Shenzhen) Ltd., Block A8 Tantou W. Ind. Par, Songgang Baoan District, Shenzhen, P.R. China 51810 T: 86-755-2768-2118 F: 86-755-2768-2218

TAIWAN: IDEAL Anderson Asia Pacific Ltd., Taiwan Branch, 4F.-2, No.116, Dadun 20th St., Situn District, Taichung City 407, Taiwan (R.O.C.) T: 886-4-2310-6451 F:886-4-2310-6460

www.andersonpower.com

CAT-PPMP REV 02



Компания «ЭлектроПласт» предлагает заключение долгосрочных отношений при поставках импортных электронных компонентов на взаимовыгодных условиях!

Наши преимущества:

- Оперативные поставки широкого спектра электронных компонентов отечественного и импортного производства напрямую от производителей и с крупнейших мировых складов;
- Поставка более 17-ти миллионов наименований электронных компонентов;
- Поставка сложных, дефицитных, либо снятых с производства позиций;
- Оперативные сроки поставки под заказ (от 5 рабочих дней);
- Экспресс доставка в любую точку России;
- Техническая поддержка проекта, помощь в подборе аналогов, поставка прототипов;
- Система менеджмента качества сертифицирована по Международному стандарту ISO 9001;
- Лицензия ФСБ на осуществление работ с использованием сведений, составляющих государственную тайну;
- Поставка специализированных компонентов (Xilinx, Altera, Analog Devices, Intersil, Interpoint, Microsemi, Aeroflex, Peregrine, Syfer, Eurofarad, Texas Instrument, Miteq, Cobham, E2V, MA-COM, Hittite, Mini-Circuits, General Dynamics и др.);

Помимо этого, одним из направлений компании «ЭлектроПласт» является направление «Источники питания». Мы предлагаем Вам помощь Конструкторского отдела:

- Подбор оптимального решения, техническое обоснование при выборе компонента;
- Подбор аналогов;
- Консультации по применению компонента;
- Поставка образцов и прототипов;
- Техническая поддержка проекта;
- Защита от снятия компонента с производства.



Как с нами связаться

Телефон: 8 (812) 309 58 32 (многоканальный)

Факс: 8 (812) 320-02-42

Электронная почта: org@eplast1.ru

Адрес: 198099, г. Санкт-Петербург, ул. Калинина, дом 2, корпус 4, литера А.