



## SINGLE CHIP PC AUDIO SYSTEM CODEC+SPEAKER AMPLIFIER+CAPLESS HP+LDO

# 92HD99

### Description

The 92HD99 single-chip audio system is a low power optimized, high fidelity, 4-channel audio codec with stereo integrated speaker amplifier, capless headphone amplifier, and low drop out voltage regulator.

The high integration of the 92HD99 enables the smallest PCB footprint with the lowest system BOM count and cost. 92HD99 provides high quality HD Audio capability to notebook and business desktop PC applications.

### Features

- **4 Channels (2 stereo DACs and 2 stereo ADCs) with 24-bit resolution**
  - Supports full-duplex stereo audio and simultaneous VoIP
- **2W Class-D stereo BTL speaker amplifier @ 4 ohms and 5V**
  - 10 band hardware parametric equalizer
  - Hardware compressor limiter
  - Dedicated BTL high pass filter for speaker protection
- **Capless headphone amplifier with charge pump/LDO**
- **Combo Jack Support allowing for dual-function headphone and headset detection**
- **Full HDA015-B low power support**
- **Internal digital core LDO voltage regulator**
- **Microsoft WLP desktop premium logo compliant**
- **Support for 1.5V and 3.3V HDA signaling**
- **Digital microphone inputs (mono or stereo mics)**
- **Microphone Mute Input (on WB revisions and beyond)**
- **High performance analog mixer**
- **2 adjustable VREF Out pins for analog microphone bias**
- **5 analog ports with port presence detect (4 single ended, 1 BTL)**
- **Analog and digital PC Beep support**
- **AUX Audio mode for playback**
- **40-pad QFN RoHS packages in Commercial and Industrial Temperature Ranges**

## Full HDA015-B low power support

- Audio inactivity transitions codec from D0 to D3 low power mode
- Resume from D3 to D0 with audio activity in < 10 msec
- D3 to D0 transition with < -65dB pop/click
- Port presence detect in D3 with or without bit clock
- PC beep wake up in D3
- Additional vendor specific modes for even lower power

## Software Support

- Intuitive TSI HD Sound graphical user interface that allows configurability and preference settings
- 12 band fully parametric equalizer
  - Constant, system-level effects tuned to optimize a particular platform can be combined with user-mode “presets” tailored for specific acoustical environments and applications
  - System-level effects automatically disabled when external audio connections made
- Dynamics Processing
  - Enables improved voice articulation
  - Compressor/limiter allows higher average volume level without resonances or damage to speakers.
- TSI Vista APO wrapper
  - Enables multiple APOs to be used with the TSI Driver
- Microphone Beam Forming, Acoustic Echo Cancellation, and Noise Suppression
- Dynamic Stream Switching
  - Improved multi-streaming user experience with less support calls
- Broad 3<sup>rd</sup> party branded software including Creative, Dolby, DTS, and SRS

**TABLE OF CONTENTS**

**1. DESCRIPTION ..... 10**

    1.1. Overview ..... 10

    1.2. Orderable Part Numbers ..... 10

**2. DETAILED DESCRIPTION ..... 11**

    2.1. Port Functionality ..... 11

        2.1.1. Port Characteristics ..... 11

        2.1.2. Vref\_Out ..... 13

        2.1.3. Jack Detect ..... 13

    2.2. Mixer ..... 13

    2.3. ADC Multiplexers ..... 14

    2.4. Power Management ..... 14

    2.5. AFG D0 ..... 15

    2.6. AFG D1 ..... 15

    2.7. AFG D2 ..... 15

    2.8. AFG D3 ..... 15

        2.8.1. AFG D3cold ..... 15

    2.9. Vendor Specific Function Group Power States D4/D5 ..... 16

    2.10. Low-voltage HDA Signaling ..... 16

    2.11. Multi-channel capture ..... 16

    2.12. EAPD ..... 18

    2.13. Digital Microphone Support ..... 21

    2.14. Analog PC-Beep ..... 24

    2.15. Digital PC-Beep ..... 26

    2.16. Headphone Drivers ..... 27

    2.17. BTL Amplifier ..... 27

    2.18. BTL Amplifier High-Pass Filter ..... 27

        2.18.1. Filter Description ..... 28

    2.19. EQ ..... 28

    2.20. Combo Jack Detection ..... 28

    2.21. GPIO ..... 29

        2.21.1. GPIO Pin mapping and shared functions ..... 29

        2.21.2. Digital Microphone/GPIO Selection ..... 29

        2.21.3. Digital Microphone/GPIO Selection ..... 29

    2.22. HD Audio HDA015-B support ..... 29

    2.23. Digital Core Voltage Regulator ..... 30

    2.24. Aux Audio Support ..... 31

        2.24.1. General conditions in Aux Audio Mode: ..... 31

        2.24.2. Entering Aux Audio Mode ..... 32

        2.24.3. "Playback Path" Port Behavior (Analog I/O) ..... 33

        2.24.4. When Port E presence detect = 0 ..... 33

        2.24.5. When Port E presence detect = 1 ..... 33

        2.24.6. SYSTEM DIAGRAMS (Analog I/O) ..... 34

        2.24.7. EAPD ..... 35

        2.24.8. Analog PC\_Beep ..... 35

        2.24.9. Class-D BTL Issues ..... 35

        2.24.10. Firmware/Software Requirements: ..... 35

    2.25. Microphone Mute Input ..... 36

**3. CHARACTERISTICS ..... 37**

    3.1. Electrical Specifications ..... 37

        3.1.1. Absolute Maximum Ratings ..... 37

        3.1.2. Recommended Operating Conditions ..... 37

    3.2. 92HD99 Analog Performance Characteristics ..... 38

    3.3. Class-D BTL Amplifier Performance ..... 41

    3.4. Capless Headphone Supply Characteristics ..... 42

    3.5. AC Timing Specs ..... 42

        3.5.1. HD Audio Bus Timing ..... 42

        3.5.2. Digital Microphone Timing ..... 43

3.5.3. GPIO Characteristics .....	43
<b>4. FUNCTIONAL BLOCK DIAGRAM .....</b>	<b>44</b>
<b>5. WIDGET DIAGRAM .....</b>	<b>45</b>
<b>6. PORT AND PIN CONFIGURATIONS .....</b>	<b>46</b>
6.1. Port Configurations .....	46
6.2. Pin Configuration Default Register Settings .....	47
<b>7. WIDGET INFORMATION .....</b>	<b>48</b>
7.1. Widget List .....	49
7.2. Reset Key .....	50
7.3. Root (NID = 00h): VendorID .....	50
7.3.1. Root (NID = 00h): RevID .....	51
7.3.2. Root (NID = 00h): NodeInfo .....	51
7.4. AFG (NID = 01h): NodeInfo .....	52
7.4.1. AFG (NID = 01h): FGType .....	52
7.4.2. AFG (NID = 01h): AFGCap .....	53
7.4.3. AFG (NID = 01h): PCMCap .....	54
7.4.4. AFG (NID = 01h): StreamCap .....	55
7.4.5. AFG (NID = 01h): InAmpCap .....	56
7.4.6. AFG (NID = 01h): PwrStateCap .....	57
7.4.7. AFG (NID = 01h): GPIOCnt .....	58
7.4.8. AFG (NID = 01h): OutAmpCap .....	58
7.4.9. AFG (NID = 01h): PwrState .....	59
7.4.10. AFG (NID = 01h): UnsolResp .....	60
7.4.11. AFG (NID = 01h): GPIO .....	60
7.4.12. AFG (NID = 01h): GPIOEn .....	61
7.4.13. AFG (NID = 01h): GPIODir .....	62
7.4.14. AFG (NID = 01h): GPIOWakeEn .....	63
7.4.15. AFG (NID = 01h): GPIOUnsol .....	64
7.4.16. AFG (NID = 01h): GPIOSticky .....	65
7.4.17. AFG (NID = 01h): SubID .....	65
7.4.18. AFG (NID = 01h): GPIOIrty .....	66
7.4.19. AFG (NID = 01h): GPIODrive .....	67
7.4.20. AFG (NID = 01h): DMic .....	68
7.4.21. AFG (NID = 01h): DACMode .....	69
7.4.22. AFG (NID = 01h): ADCMode .....	70
7.4.23. AFG (NID = 01h): PortUse .....	71
7.4.24. AFG (NID = 01h): ComJack .....	72
7.4.25. AFG (NID = 01h): VSPwrState .....	73
7.4.26. AFG (NID = 01h): AnaPort .....	74
7.4.27. AFG (NID = 01h): AnaBTL .....	75
7.4.28. AFG (NID = 01h): AnaBTLStatus .....	77
7.4.29. AFG (NID = 01h): AnaCapless .....	77
7.4.30. AFG (NID = 01h): Reset .....	80
7.4.31. AFG (NID = 01h): AnaBeep .....	81
7.4.32. AFG (NID = 01h): EAPD .....	82
7.4.33. AFG (NID = 01h): ComboJackTime (Available only on WB revision and beyond) .....	84
7.5. PortA (NID = 0Ah): WCap .....	86
7.5.1. PortA (NID = 0Ah): PinCap .....	87
7.5.2. PortA (NID = 0Ah): ConLst .....	88
7.5.3. PortA (NID = 0Ah): ConLstEntry0 .....	89
7.5.4. PortA (NID = 0Ah): InAmpLeft .....	89
7.5.5. PortA (NID = 0Ah): InAmpRight .....	90
7.5.6. PortA (NID = 0Ah): ConSelectCtrl .....	90
7.5.7. PortA (NID = 0Ah): PwrState .....	91
7.5.8. PortA (NID = 0Ah): PinWCntrl .....	91
7.5.9. PortA (NID = 0Ah): UnsolResp .....	92
7.5.10. PortA (NID = 0Ah): ChSense .....	93
7.5.11. PortA (NID = 0Ah): EAPDBTLR .....	93
7.5.12. PortA (NID = 0Ah): ConfigDefault .....	94

7.6. PortB (NID = 0Bh): WCap .....	96
7.6.1. PortB (NID = 0Bh): PinCap .....	98
7.6.2. PortB (NID = 0Bh): ConLst .....	99
7.6.3. PortB (NID = 0Bh): ConLstEntry0 .....	100
7.6.4. PortB (NID = 0Bh): ConSelectCtrl .....	100
7.6.5. PortB (NID = 0Bh): PwrState .....	100
7.6.6. PortB (NID = 0Bh): PinWCntrl .....	101
7.6.7. PortB (NID = 0Bh): UnsolResp .....	102
7.6.8. PortB (NID = 0Bh): ChSense .....	102
7.6.9. PortB (NID = 0Bh): EAPDBTLLR .....	103
7.6.10. PortB (NID = 0Bh): ConfigDefault .....	103
7.7. PortC (NID = 0Ch): WCap .....	106
7.7.1. PortC (NID = 0Ch): PinCap .....	107
7.7.2. PortC (NID = 0Ch): ConLst .....	108
7.7.3. PortC (NID = 0Ch): ConLstEntry0 .....	109
7.7.4. PortC (NID = 0Ch): InAmpLeft .....	109
7.7.5. PortC (NID = 0Ch): InAmpRight .....	110
7.7.6. PortC (NID = 0Ch): ConSelectCtrl .....	110
7.7.7. PortC (NID = 0Ch): PwrState .....	111
7.7.8. PortC (NID = 0Ch): PinWCntrl .....	111
7.7.9. PortC (NID = 0Ch): UnsolResp .....	112
7.7.10. PortC (NID = 0Ch): ChSense .....	113
7.7.11. PortC (NID = 0Ch): EAPDBTLLR .....	113
7.7.12. PortC (NID = 0Ch): ConfigDefault .....	114
7.8. PortD (NID = 0Dh): WCap .....	117
7.8.1. PortD (NID = 0Dh): PinCap .....	118
7.8.2. PortD (NID = 0Dh): ConLst .....	119
7.8.3. PortD (NID = 0Dh): ConLstEntry0 .....	120
7.8.4. PortD (NID = 0Dh): ConSelectCtrl .....	120
7.8.5. PortD (NID = 0Dh): PwrState .....	121
7.8.6. PortD (NID = 0Dh): PinWCntrl .....	122
7.8.7. PortD (NID = 0Dh): EAPDBTLLR .....	122
7.8.8. PortD (NID = 0Dh): ConfigDefault .....	122
7.9. (NID = 0Eh): Vendor Reserved .....	126
7.10. PortF (NID = 0Fh): WCap .....	127
7.10.1. PortF (NID = 0Fh): PinCap .....	128
7.10.2. PortF (NID = 0Fh): ConLst .....	129
7.10.3. PortF (NID = 0Fh): ConLstEntry0 .....	130
7.10.4. PortF (NID = 0Fh): InAmpLeft .....	130
7.10.5. PortF (NID = 0Fh): InAmpRight .....	131
7.10.6. PortF (NID = 0Fh): ConSelectCtrl .....	131
7.10.7. PortF (NID = 0Fh): PwrState .....	132
7.10.8. PortF (NID = 0Fh): PinWCntrl .....	132
7.10.9. PortF (NID = 0Fh): UnsolResp .....	133
7.10.10. PortF (NID = 0Fh): ChSense .....	134
7.10.11. PortF (NID = 0Fh): EAPDBTLLR .....	134
7.10.12. PortF (NID = 0Fh): ConfigDefault .....	135
7.11. (NID = 10h): Vendor Reserved .....	138
7.12. DMic0 (NID = 11h): WCap .....	139
7.12.1. DMic0 (NID = 11h): PinCap .....	140
7.12.2. DMic0 (NID = 11h): InAmpLeft .....	141
7.12.3. DMic0 (NID = 11h): InAmpRight .....	142
7.12.4. DMic0 (NID = 11h): PwrState .....	142
7.12.5. DMic0 (NID = 11h): PinWCntrl .....	143
7.12.6. DMic0 (NID = 11h): UnsolResp .....	144
7.12.7. DMic0 (NID = 11h): ChSense .....	144
7.12.8. DMic0 (NID = 11h): ConfigDefault .....	145
7.13. (NID = 12h): Vendor Reserved .....	148
7.14. DAC0 (NID = 13h): WCap .....	149

7.14.1. DAC0 (NID = 13h): Cnvtr .....	150
7.14.2. DAC0 (NID = 13h): OutAmpLeft .....	151
7.14.3. DAC0 (NID = 13h): OutAmpRight .....	152
7.14.4. DAC0 (NID = 13h): PwrState .....	152
7.14.5. DAC0 (NID = 13h): CnvtrID .....	153
7.14.6. DAC0 (NID = 13h): EAPDBTLLR .....	154
7.15. DAC1 (NID = 14h): WCap .....	154
7.15.1. DAC1 (NID = 14h): Cnvtr .....	156
7.15.2. DAC1 (NID = 14h): OutAmpLeft .....	157
7.15.3. DAC1 (NID = 14h): OutAmpRight .....	157
7.15.4. DAC1 (NID = 14h): PwrState .....	158
7.15.5. DAC1 (NID = 14h): CnvtrID .....	159
7.15.6. DAC1 (NID = 14h): EAPDBTLLR .....	159
7.16. ADC0 (NID = 15h): WCap .....	160
7.16.1. ADC0 (NID = 15h): ConLst .....	161
7.16.2. ADC0 (NID = 15h): ConLstEntry0 .....	162
7.16.3. ADC0 (NID = 15h): Cnvtr .....	162
7.16.4. ADC0 (NID = 15h): ProcState .....	163
7.16.5. ADC0 (NID = 15h): PwrState .....	164
7.16.6. ADC0 (NID = 15h): CnvtrID .....	165
7.17. ADC1 (NID = 1Bh): WCap .....	165
7.17.1. ADC1 (NID = 1Bh): ConLst .....	167
7.17.2. ADC1 (NID = 1Bh): ConLstEntry0 .....	167
7.17.3. ADC1 (NID = 1Bh): Cnvtr .....	168
7.17.4. ADC1 (NID = 1Bh): ProcState .....	169
7.17.5. ADC1 (NID = 1Bh): PwrState .....	170
7.17.6. ADC1 (NID = 1Bh): CnvtrID .....	171
7.18. ADC0Mux (NID = 17h): WCap .....	172
7.18.1. ADC0Mux (NID = 17h): ConLst .....	173
7.18.2. ADC0Mux (NID = 17h): ConLstEntry4 .....	174
7.18.3. ADC0Mux (NID = 17h): ConLstEntry0 .....	174
7.18.4. ADC0Mux (NID = 17h): OutAmpCap .....	175
7.18.5. ADC0Mux (NID = 17h): OutAmpLeft .....	176
7.18.6. ADC0Mux (NID = 17h): OutAmpRight .....	176
7.18.7. ADC0Mux (NID = 17h): ConSelectCtrl .....	177
7.18.8. ADC0Mux (NID = 17h): PwrState .....	177
7.18.9. ADC0Mux (NID = 17h): EAPDBTLLR .....	178
7.19. ADC1Mux (NID = 18h): WCap .....	179
7.19.1. ADC1Mux (NID = 18h): ConLst .....	181
7.19.2. ADC1Mux (NID = 18h): ConLstEntry4 .....	181
7.19.3. ADC1Mux (NID = 18h): ConLstEntry0 .....	182
7.19.4. ADC1Mux (NID = 18h): OutAmpCap .....	182
7.19.5. ADC1Mux (NID = 18h): OutAmpLeft .....	183
7.19.6. ADC1Mux (NID = 18h): OutAmpRight .....	183
7.19.7. ADC1Mux (NID = 18h): ConSelectCtrl .....	184
7.19.8. ADC1Mux (NID = 18h): PwrState .....	184
7.19.9. ADC1Mux (NID = 18h): EAPDBTLLR .....	185
7.20. (NID = 19h): Vendor Reserved .....	186
7.21. (NID = 1Ah): Vendor Reserved .....	186
7.22. Mixer (NID = 1Bh): WCap .....	187
7.22.1. Mixer (NID = 1Bh): InAmpCap .....	188
7.22.2. Mixer (NID = 1Bh): ConLst .....	189
7.22.3. Mixer (NID = 1Bh): ConLstEntry4 .....	189
7.22.4. Mixer (NID = 1Bh): ConLstEntry0 .....	190
7.22.5. Mixer (NID = 1Bh): InAmpLeft0 .....	190
7.22.6. Mixer (NID = 1Bh): InAmpRight0 .....	191
7.22.7. Mixer (NID = 1Bh): InAmpLeft1 .....	191
7.22.8. Mixer (NID = 1Bh): InAmpRight1 .....	192
7.22.9. Mixer (NID = 1Bh): InAmpLeft2 .....	192

7.22.10. Mixer (NID = 1Bh): InAmpRight2 .....	193
7.22.11. Mixer (NID = 1Bh): InAmpLeft3 .....	193
7.22.12. Mixer (NID = 1Bh): InAmpRight3 .....	194
7.22.13. Mixer (NID = 1Bh): InAmpLeft4 .....	194
7.22.14. Mixer (NID = 1Bh): InAmpRight4 .....	195
7.22.15. Mixer (NID = 1Bh): InAmpLeft5 .....	195
7.22.16. Mixer (NID = 1Bh): InAmpRight5 .....	196
7.22.17. Mixer (NID = 1Bh): PwrState .....	196
7.23. MixerOutVol (NID = 1Ch): WCap .....	197
7.23.1. MixerOutVol (NID = 1Ch): ConLst .....	199
7.23.2. MixerOutVol (NID = 1Ch): ConLstEntry0 .....	199
7.23.3. MixerOutVol (NID = 1Ch): OutAmpCap .....	200
7.23.4. MixerOutVol (NID = 1Ch): OutAmpLeft .....	201
7.23.5. MixerOutVol (NID = 1Ch): OutAmpRight .....	201
7.23.6. MixerOutVol (NID = 1Ch): PwrState .....	202
7.24. (NID = 1Dh): Vendor Reserved .....	203
7.25. (NID = 1Eh): Vendor Reserved .....	203
7.26. (NID = 1Fh): Vendor Reserved .....	203
7.27. (NID = 20h): Vendor Reserved .....	203
7.28. DigBeep (NID = 21h): WCap .....	204
7.28.1. DigBeep (NID = 21h): OutAmpCap .....	205
7.28.2. DigBeep (NID = 21h): OutAmpLeft .....	205
7.28.3. DigBeep (NID = 21h): PwrState .....	206
7.28.4. DigBeep (NID = 21h): Gen .....	207
7.28.5. DigBeep (NID = 21h): Gain .....	207
7.29. AdvancedFunctions (NID = 22h): WCap .....	208
7.29.1. AdvancedFunctions (NID = 22h): Cntrl0 .....	209
<b>8. PINOUT AND PACKAGING .....</b>	<b>223</b>
8.0.1. 40QFN Pin Table .....	224
8.0.2. 40QFN Package Outline and Package Dimensions .....	225
8.1. Standard Reflow Profile Data .....	226
<b>9. DISCLAIMER .....</b>	<b>227</b>
<b>10. DOCUMENT REVISION HISTORY .....</b>	<b>228</b>

**LIST OF FIGURES**

Figure 1. Multi-channel capture ..... 17

Figure 2. Multi-channel timing diagram ..... 17

Figure 3. HP EAPD Example to be replaced by single pin for internal amp ..... 21

Figure 4. EAPD implementation ..... 21

Figure 5. Single Digital Microphone (data is ported to both left and right channels ..... 23

Figure 6. Stereo Digital Microphone Configuration ..... 24

Figure 7. Analog PC Beep Active ..... 25

Figure 8. Analog PC Beep Flow chart ..... 26

Figure 9. Combo Jack ..... 28

Figure 10. Switching between Normal and Aux Audio Modes ..... 32

Figure 11. Aux Audio Playback When Nothing Plugged In (or System is not Docked) ..... 34

Figure 12. Aux Audio Playback When System Headphones are Plugged In ..... 34

Figure 13. Aux Audio Playback when the System is Docked and Headphones are Plugged In ..... 35

Figure 14. HD Audio Bus Timing ..... 42

Figure 15. Functional Block Diagram ..... 44

Figure 16. Widget Diagram ..... 45

Figure 17. Port Configurations ..... 46

Figure 18. 40QFN Pin Assignment ..... 223

Figure 19. 40QFN Package Diagram ..... 225



LIST OF TABLES

Table 1. Port Functionality ..... 11  
Table 2. Analog Output Port Behavior ..... 12  
Table 3. 48pin Jack Detect ..... 13  
Table 4. Power Management ..... 14  
Table 5. Example channel mapping ..... 17  
Table 7. EAPD Pin Mode Select ..... 19  
Table 8. Control bit descriptions for BTL amplifier and Headphone amplifier enable configurations ..... 19  
Table 9. BTL Amp Enable Configuration ..... 19  
Table 11. EAPD Analog PC\_Beep behavior ..... 20  
Table 12. EAPD Behavior ..... 20  
Table 10. Headphone Amp Enable Configuration ..... 20  
Table 13. Valid Digital Mic Configurations ..... 22  
Table 14. DMIC\_CLK and DMIC\_0 Operation During Power States ..... 22  
Table 15. Electrical Specification: Maximum Ratings ..... 37  
Table 16. Recommended Operating Conditions ..... 37  
Table 17. 92HD99 Analog Performance Characteristics ..... 38  
Table 18. Class-D BTL Amplifier Performance ..... 41  
Table 19. Capless Headphone Supply ..... 42  
Table 20. HD Audio Bus Timing ..... 42  
Table 21. Digital Mic timing ..... 43  
Table 22. GPIO Characteristics ..... 43  
Table 23. Pin Configuration Default Settings ..... 47  
Table 24. Command Format for Verb with 4-bit Identifier ..... 48  
Table 25. Command Format for Verb with 12-bit Identifier ..... 48  
Table 26. Solicited Response Format ..... 48  
Table 27. Unsolicited Response Format ..... 48  
Table 28. Widget List ..... 49  
Table 29. 40QFN Pin Description ..... 224  
Table 30. Standard Reflow Profile ..... 226

## 92HD99

### SINGLE CHIP PC AUDIO SYSTEM, CODEC+SPEAKER AMPLIFIER+CAPLESS HP+LDO

## 1. DESCRIPTION

### 1.1. Overview

The 92HD99 audio CODEC provides stereo 24-bit, full duplex resolution supporting sample rates up to 192kHz by the DAC and ADC.

An integrated BTL stereo amplifier is ideal for driving 4ohm or 8ohm integrated speakers in mobile and ultra-mobile computers. For desktop computers or mobile computers using only one speaker, the BTL output stage may be configured to support a single mono speaker.

Port presence detect capabilities allow the CODEC to detect when audio devices are connected to the CODEC. The fully parametric Internal EQ can be initiated upon headphone jack insertion and removal for protection of notebook speakers.

The 92HD99 audio CODEC operates with a 3.3V digital supply and a 5V (4.75V allowed when using external voltage regulator) analog supply. It allows for 1.5V and 3.3V HDA signaling; the correct signalling level is selected dynamically based on the power supply voltage on the DVDD-IO pin.

The 92HD99 audio CODEC is offered in a 40-pin QFN Environmental (ROHS) package.

### 1.2. Orderable Part Numbers

92HD99B1X5NDGXyyX	HDA 3.3V, Aux mode
92HD99B2X5NDGXyyX	HDA 3.3V, No Aux mode
92HD99B3X5NDGXyyX	HDA 1.5V, Aux mode
92HD99B4X5NDGXyyX	HDA 1.5V, No Aux mode
92HD99B1X5NDGIyyX	HDA 3.3V, Aux mode. Industrial Temp
92HD99B2X5NDGIyyX	HDA 3.3V, No Aux mode. Industrial Temp
92HD99B3X5NDGIyyX	HDA 1.5V, Aux mode. Industrial Temp
92HD99B4X5NDGIyyX	HDA 1.5V, No Aux mode. Industrial Temp

yy = silicon stepping/revision, contact sales for current data.  
Add an "8" to the end for tape and reel delivery.

Please note that Industrial Temp is only available on revision WC and forward.

## 2. DETAILED DESCRIPTION

### 2.1. Port Functionality

Multi-function (Input/Output) ports allow for the highest possible flexibility. 7 bi-directional ports, 2 are headphone capable, support a wide variety of consumer desktop and mobile system use models.

- Port A supports
  - Headphone Out
  - Line Out
  - Line Input
  - Mic with 0/10/20/30 dB Boost
- Port B supports
  - Capless Headphone Out
  - Capless Line Out
- Port C
  - Line In
  - Line Out
  - Mic with 0/10/20/30 dB Boost
- Port D supports
  - BTL stereo out
- Port F supports
  - Line In
  - Line Out
  - Mic with 0/10/20/30 dB Boost

Pins 40-QFN	Port	Input	Output	Headphone	BTL	Mic Bias (Vref pin)	Input boost amp
22/23	A	Yes	Yes	Yes		Yes	Yes
25/26	B		Yes	Yes			
15/16	C	Yes	Yes			Yes	Yes
34/35/37/38	D		Yes		Yes		
13/14	F	Yes	Yes				Yes
3 (CLK=2)	DMIC0	Yes					Yes

Table 1. Port Functionality

#### 2.1.1. Port Characteristics

Universal (Bi-directional) jacks are supported on ports A,C, and F. Ports A and B are designed to drive 32 ohm (nominal) headphones or a 10K (nominal) load. Line Level outputs are intended to drive an external 10K load (nominal) and an on board shunt resistor of 20-47K (nominal). However, applications may support load impedances of 5K ohms and above. Input ports are 50K (nominal) at the pin.

DAC full scale outputs and intended full scale input levels are 1V rms at 5V. Line output ports and Headphone output ports on the 92HD99 codec may be configured for +3dBV full scale output levels by using a vendor specific verb.

Output ports are always on to prevent pops/clicks associated with charging and discharging output coupling capacitors. This maintains proper bias on output coupling caps even in power state D3 as long as AVDD is available. Unused ports should be left unconnected. When updating existing

# 92HD99

## SINGLE CHIP PC AUDIO SYSTEM, CODEC+SPEAKER AMPLIFIER+CAPLESS HP+LDO

designs to use the 92HD99 codec, ensure that there are no conflicts between the output ports on the codec and existing circuitry.

AFG Power State	Input Enable	Output Enable	Used as output for DAC/Mixer	Used as output for analog PC_Beep	Used as input for ADC, mixer	Port Behavior
D0-D2	1	1	Don't care	Don't care	Yes	Not allowed. Port is active as input.
					No	Not allowed. Inactive (Power Down) - Port keeps output coupling caps charged if port uses caps.
	1	0	NA	NA	Yes	Active - Port enabled as input
	1	0	NA	NA	No	Inactive (Power Down) - Port keeps output coupling caps charged if port uses caps.
	0	1	currently used by DAC, mixer, beep, or is traditional line or headphone output		NA	Active - Port enabled as output
			not currently used by DAC, mixer, beep and is capless HP/BTL port			Inactive (Power Down)
	0	0	NA	NA	NA	Inactive (Power Down) - Port keeps output coupling caps charged if port uses caps.
D3	1	1	NA	NA	Don't care	Not allowed. Inactive (Power Down) - Port keeps output coupling caps charged if port uses caps.
	1	0	NA	NA	Don't care	Inactive (Power Down) - Port keeps output coupling caps charged if port uses caps.
	0	1	currently used by DAC, mixer, beep, or is traditional line or headphone output		Don't care	Low power state. If enabled, Beep will output from the port
	0	1	not currently used by DAC, mixer, beep and is capless HP/BTL port		Don't care	Inactive (Power Down)
	0	0	NA	NA	Don't care	Inactive (Power Down) - Port keeps output coupling caps charged if port uses caps.
D3cold	-	-				Inactive (lower power) - Port keeps output coupling caps charged if port uses caps.
D4	-	-				Inactive (lower power) - Port keeps output coupling caps charged if port uses caps.
D5	-	-				Off - Charge on coupling caps (if used) will not be maintained.

**Table 2. Analog Output Port Behavior**

### 2.1.2. Vref\_Out

Ports C, & A support Vref\_Out pins for biasing electret cartridge microphones. Settings of 80%

AVDD, 50% AVDD, GND, and Hi-Z are supported. Attempting to program a pin widget control with a reserved or unsupported value will cause the associated Vref\_Out pin to assume a Hi-Z state and the pin widget control Vref\_En field will return a value of '000' (Hi-Z) when read.

### 2.1.3. Jack Detect

Plugs inserted to a jack on Ports A, B, C are detected using SENSE\_A. Plugs inserted to a jack on Port F, DMIC0, are detected using SENSE\_B. Per HDA015-B, the detection circuit operates when the CODEC is in D0 - D3 and can also operate if both the CODEC and Controller are in D3 (no bus clock.) Jack detection requires that all supplies (analog and digital) are active and stable. When AVDD is not present, the value reported in the pin widget is invalid.

When the HD Audio bus is in a low power state (reset asserted and clock stopped) the CODEC will generate a Power State Change Request when a change in port connectivity is sensed and then generate an unsolicited response after the HD Audio link has been brought out of a low power state and the device has been enumerated. Per HDA015-B, this will take less than 10mS.

The following table summarizes the proper resistor tolerances for different analog supply voltages..

AVdd Nominal Voltage (+/- 5%)	Resistor Tolerance Pull-Up	Resistor Tolerance SENSE_A/B
4.75V	1%	1%

Resistor	SENSE_A	SENSE_B
39.2K	PORT A (HP0)	
20.0K	PORT B (HP1)	PORT F
10.0K	PORT C	DMIC0
5.11K		
2.49K	Pull-up to AVDD	Pull-up to AVDD

**Table 3. 48pin Jack Detect**

See reference design for more information on Jack Detect implementation.

## 2.2. Mixer

The mixer supports independent gain (-34.5 to +12dB in 1.5dB steps) on each input as well as independent mutes on each input. The following inputs are available:

- Port A
- Port C
- Port F
- DAC 0
- DAC 1

## 2.3. ADC Multiplexers

The codec implements 2 ADC input multiplexers. These multiplexers incorporate the ADC record gain function :(-16 to +30dB gain in 1dB steps) as an output amp and allow a preselection of one of below possible inputs:

- Port A
- Port C
- Port F
- Mixer Output
- DMIC 0

## 2.4. Power Management

The HD Audio specification defines power states, power state widgets, and power state verbs. Power management is implemented at several levels. The Audio Function Group (AFG) , all converter widgets, and all pin complexes support the power state verb F05/705. Converter widgets are active in D0 and inactive in D1-D3.

The following table describes what functionality is active in each power state.

Function	D0	D1 <sup>1</sup>	D2	D3	D3cold	Vendor Specific D4	Vendor Specific D5
Digital Microphone inputs	On	Off	Off	Off	Off	Off	Off
DAC	On	Off	Off	Off	Off	Off	Off
D2S	On	Off	Off	Off	Off	Off	Off
ADC	On	Off	Off	Off	Off	Off	Off
ADC Volume Control	On	Off	Off	Off	Off	Off	Off
Ref ADC	On	Off	Off	Off	Off	Off	Off
Analog Clocks	On	Off	Off	Off	Off	Off	Off
GPIO pins	On	On	On	On <sup>5</sup>	On	On	Off
VrefOut Pins	On	On	Off	Off	Off	Off	Off
Input Boost	On	On	Off	Off	Off	Off	Off
Analog mixer	On	On	Off	Off	Off	Off	Off
Mixer Volumes	On	On	Off	Off	Off	Off	Off
Analog PC_Beep	On	On	On	On	Off	Off	Off
Digital PC_Beep	On	On	On	On <sup>5</sup>	Off	Off	Off
Lo/HP Amps	On	On	On	Low Drive <sup>2</sup>	Low Drive <sup>2</sup>	Low Drive <sup>2</sup>	Off
Cap-less HP Amps	On	On	On	Low Drive <sup>2</sup>	Low Drive <sup>2</sup>	Low Drive <sup>2</sup>	Off
BTL Amp	On	On	On	Low Drive <sup>2</sup>	Off	Off	Off
VAG amp	On	On	On	Low Drive <sup>3</sup>	Low Drive	Low Drive	Off
Port Sense	On	On	On	On <sup>4</sup>	Off	Off	Off
Reference Bias generator	On	On	On	On	On	On	Off
Reference Bandgap core	On	On	On	On	On	On	Off
HD Audio-Link	On	On	On	On <sup>5</sup>	Limited	Off	Off

**Table 4. Power Management**

1. No DAC or ADC streams are active. Analog mixing and loop thru are supported.

2. VAG is kept active when ports are disabled or in D3/D3cold/D4. PC\_Beep is supported in D3 but may be attenuated and distorted depending on load impedance. The codec will shut down the capless headphone amplifiers and BTL amplifier in D3 and below. In D3, Hendrix/Kaveri will turn on the BTL and Capless amplifiers if activity is detected on the PC\_BEEP input and analog PC\_Beep is enabled.
3. VAG is always ramped up and down gradually, except in the case of a sudden power removal. VAG is active in D2/D3 but in a low power state.
4. Both AVDD and DVDD must be available for Port Sense to operate.
5. Not active if BITCLK is not running (Controller in D3), but can signal power state change request (PME)

The D3-default state is available for HD Audio compliance. The programmable values, exposed via vendor-specific settings, are under TSI Device Driver control for further power reduction. The analog mixer, line and headphone amps, port presence detect, and internal references may be disabled using vendor specific verbs. Use of these vendor specific verbs will cause pops.

The default power state for the Audio Function Group after reset is D3.

## 2.5. AFG D0

The AFG D0 state is the active state for the device. All functions are active if their power state (if they support power management at their node level) has been set to D0.

## 2.6. AFG D1

D1 is a lower power mode where all converter widgets are disabled. Analog mixer and port functions are active. The part will resume from the D1 to the D0 state within 1 mS.

## 2.7. AFG D2

The D2 state further reduces power by disabling the mixer and port functions. The port amplifiers and internal references remain active to keep port coupling caps charged and the system ready for a quick resume to either the D1 or D0 state. The part will resume from the D2 state to the D0 state within 2mS.

## 2.8. AFG D3

The D3-default state is available for HD Audio compliance. All converters are shut down. Port amplifiers and references are active but in a low power state to prevent pops. Resume times may be longer than those from D2, but still less than 10mS to meet Intel low power goals. The default power state for the Audio Function Group after power is applied is D3.

While in AFG D3, the HD Audio controller may be in a D0 state (HD Audio bus active) or in a D3 state (HD Audio bus held in reset with no Bit\_Clk, SData\_Out, or Sync activity.) The expected behavior is as follows (see the HDA015-B section for more information):

Function	HDA Bus active	HDA Bus stopped
Port Presence Detect state change	Unsolicited Response	Wake Event followed by an unsolicited response
GPIO state change	Unsolicited Response	Wake Event followed by an unsolicited response

### 2.8.1. AFG D3cold

The D3cold power state is the lowest power state available that does not use vendor specific verbs. While in D3cold, the CODEC will still respond to bus requests to revert to a higher power state (dou-

ble AFG reset, link reset). However, audio processing, port presence detect, and other functions are disabled. Per the HD Audio bus HDA015-B, the D3cold state is intended to be used just prior to removing power to the CODEC. Typically, power will be removed within 200mS. However, the codec may exit from the D3cold state by generating 2, back-to-back, AFG reset events. Resume time from D3cold is less than 200mS.

## 2.9. Vendor Specific Function Group Power States D4/D5

The codec introduces vendor specific power states. A vendor defined verb is added to the Audio Function Group that combines multiple vendor specific power control bits into logical power states for use by the audio driver. The 2 states defined offer lower power than the 5 existing states defined in the HD Audio specification and HDA015-B. The Vendor Specific D4 state provides lower digital power consumption relative to D3cold by disabling HD Audio link responses. Vendor specific D5 further reduces power consumption on the digital supply by turning off GPIO drivers, and reduces analog power consumption by turning off all analog circuitry except for reset circuits.

States D4/D5 are not entered until D3cold has been requested so are actually D3cold options rather than true, independent, power states. Software can pre-program the D4 or D5 state as a re-definition of how the part will behave when the D3cold power state is requested or software may enter D3cold, then set the D4 or D5 before performing the power state get command. The preferred method is to request D3cold, then select D4 or D5 as desired. This will reduce the severity of pops encountered when entering D4 or D5.

Both power states require a link reset or removal of DVDD to exit.

The CODEC may pop when using these verbs and transition times to an active state (D1 or D0 for example) may take several seconds.

## 2.10. Low-voltage HDA Signaling

The codec is compatible with either 1.5V or 3.3V HDA bus signaling; in the 48QFN package the voltage selection is done dynamically based on the input voltage of DVDD\_IO.

DVDD\_IO is currently not a logic configuration pin, but rather provides the digital power supply to be used for the HDA bus signals.

When in 1.5V mode, the codec can correctly decode BITCLK, SYNC, RESET# and SDO as they operate at 1.5V; additionally it will drive SDI and SDO at 1.5V. None of the GPIOs are affected, as they always function at their nominal voltage (DVDD or AVDD).

## 2.11. Multi-channel capture

The capability to assign multiple "ADC Converters" to the same stream is supported to meet the microphone array requirements of Vista and future operating systems. Single converter streams are still supported this is done by assigning unique non zero Stream IDs to each converter. All capture devices (ADCs 0 and 1) may be used to create a multi-channel input stream. There are no restrictions regarding digital microphones.

The ADC Converters can be associated with a single stream as long the sample rate and the bits per sample are the same. The assignment of converter to channel is done using the "CnvtrID" widget and is restricted to even values. The ADC converters will always put out a stereo sample and therefore require 2 channels per converter.



The stream will not be generated unless all entries for the targeted converters are set identically, and the total number of assigned converter channels matches the value in the NmbrChan field. These are listed the “Multi-Converter Stream Critical Entries.” table.

An example of a 4 Channel Steam with ADC0 supplying channels 0&1 and ADC1 supplying channels 2 & 3 is shown below. A 4 Channel stream can be created by assigning the same non-zero stream id “Strm= N” to both ADC0 and ADC1. The sample rates must be set the same and the number of channels must be set to 4 channels “NmbrChan = 0011”.

ADC1 CnvtrID	(NID = 0x08)	
	[3:0]	Ch = 2
ADC0 CnvtrID	(NID = 0x07)	
	[3:0]	Ch=0

Table 5. Example channel mapping

Figure 1. Multi-channel capture



The following figure describes the bus waveform for a 24-bit, 48KHz capture stream with ID set to 1.

Figure 2. Multi-channel timing diagram



ADC[1:0] Cnvtr	Bit Number	Sub Field Name	Description
	[15]	StrmType	Stream Type (TYPE): 0: PCM 1: Non-PCM (not supported)
	[14]	FrmtSmplRate	Sample Base Rate 0= 48kHz 1=44.1KHz

Table 6: Mult-channel

	[13:11]	SmplRateMultp	Sample Base Rate Multiple 000=48kHz/44.1kHz or less 001= x2 010= x3 (not supported) 011= x4 192kHz only, 176.4 not supported 100-111= Reserved
	[10:8]	SmplRateDiv	Sample Base Rate Divisor 000= Divide by 1 001= Divide by 2 (not supported) 010= Divide by 3 (not supported) 011= Divide by 4 (not supported) 100= Divide by 5 (not supported) 101= Divide by 6 (not supported) 110= Divide by 7 (not supported) 111= Divide by 8 (not supported)
	[6:4]	BitsPerSmpl	Bits per Sample 000= 8 bits (not supported) 001= 16 bits 010= 20 bits 011= 24 bits 100-111= Reserved
	[3:0]	NmbrChan	Number of Channels Number of channels for this stream in each “sample block” of the “packets” in each “frame” on the link. 0000=1 channel (not supported) 0001 = 2 channels ... 1111= 16 channels.
	[7:4]	Strm	Software-programmable integer representing link stream ID used by the converter widget. By convention stream 0 is reserved as unused.
	[3:0]	Ch	Integer representing lowest channel used by converter. 0 and 2 are valid Entries If assigned to the same stream, one ADC must be assigned a value of 0 and the other ADC assigned a value of 2.

Table 6: Mult-channel

## 2.12. EAPD

The EAPD pin (pin 47) is a dedicated, bi-directional control pin. Although named External Amplifier Power Down (EAPD) by the HD Audio specification, this pin operates as an external amplifier power up signal. The EAPD value is reflected on the EAPD pin; a 1 causes the external amplifier to power up (equivalent to D0), and a 0 causes it to power down (equivalent to D3.) When the EAPD value = 1, the EAPD pin must be placed in a state appropriate to the current power state of the associated Pin Widget even though the EAPD value (in the register) may remain 1. The default state of this pin is 0 (driving low.) The pin defaults to an open-drain configuration (an external pull-up is recommended.)

Per the HD Audio specification and HDA015-B, multiple ports may control EAPD. The EAPD pin assumes the highest power state of all the the EAPD bits in all of the pin complexes. The default value of EAPD is 1 (powered on), but the FG power state will override and the pin will be low. A port will request External Amp Power Up when its power state is active (FG and pin widget power state is

D1 or D0) or (Analog PC\_Beep is enabled and port is enabled as an output) and the port's EAPD bit is set to 1. The state of the EAPD pin (unless configured as an input or held low by an external circuit when configured as an open drain output) will be the logical OR of the external amp power up requests from all ports.

By default, the EAPD pin also functions as the Mute#/ShutDown# input for the internal BTL amplifier. In this mode, a low value at the pin (either due to internal EAPD being 0, or to an external entity forcing the pin low) will cause the internal BTL amplifier to mute or enter a low power state depending on the amplifier configuration. (See below)

Vendor specific verbs are available to configure this pin. These verbs retain their values across link and single function group resets but are set to their default values by a power on reset:

MODE1	MODE0	EAPD Pin Function	Description
0	0	Open Drain I/O	Value at pin is wired-AND of EAPD bit and external signal.(default)
0	1	CMOS Output	Value of EAPD bit in pin widget is forced at pin
1	0	CMOS Input	External signal controls internal amps. EAPD bit in pin widget ignored
1	1	CMOS Input	External signal controls internal amps. EAPD bit in pin widget ignored

Table 7. EAPD Pin Mode Select

Control Flag	Description
EAPD PIN MODE 1:0	Defines if EAPD pin is used as input, output, or bi-directional port (Open Drain)
BTL/HP SD	0 = Amp controlled by EAPD pin only (default) / 1 = Amp controlled by power state (pin and FG) only
BTL/HP SD MODE	0 = Amp will mute when disabled. / 1 = Amp will shut down (enter a low power state) when disabled (default for YA forward)
BTL/HP SD INV	0 = AMP will power down (or mute) when EAPD pin is low (default) / 1 = Amp will power down (or mute) when EAPD pin is high.

Table 8. Control bit descriptions for BTL amplifier and Headphone amplifier enable configurations

BTL SD	BTL SD MODE	BTL SD INV	EAPD Pin State	BTL Amp State
0	0	0	0	Amplifier is mute (default <sup>1</sup> )
0	0	0	1	Amplifier is active
0	0	1	0	Amplifier is active
0	0	1	1	Amplifier is mute
0	1	0	0	Amplifier is in a low power state
0	1	0	1	Amplifier is active
0	1	1	0	Amplifier is active
0	1	1	1	Amplifier is in a low power state
1	0	NA	NA	Amplifier follows pin/function group power state and will mute when disabled
1	1	NA	NA	Amplifier follows pin/function group power state and will enter a low power state when disabled

Table 9. BTL Amp Enable Configuration

1. EAPD bit is set to one by default but the EAPD state is 0 after power-on reset because the function group is not in D0. The state after a single or double function group reset will be compliant with HDA015-B.

# 92HD99

## SINGLE CHIP PC AUDIO SYSTEM, CODEC+SPEAKER AMPLIFIER+CAPLESS HP+LDO

HP SD	HP SD MODE	HP SD INV	EAPD Pin State	Headphone Amp State
0	0	0	0	Amplifier is mute (default <sup>1</sup> )
0	0	0	1	Amplifier is active
0	0	1	0	Amplifier is active
0	0	1	1	Amplifier is mute
0	1	0	0	Amplifier is in a low power state
0	1	0	1	Amplifier is active
0	1	1	0	Amplifier is active
0	1	1	1	Amplifier is in a low power state
1	0	NA	NA	Amplifier follows pin/function group power state and will mute when disabled
1	1	NA	NA	Amplifier follows pin/function group power state and will enter a low power state when disabled

**Table 10. Headphone Amp Enable Configuration**

1. EAPD bit is set to one by default but the EAPD state is 0 after power-on reset because the function group is not in D0. The state after a single or double function group reset will be compliant with HDA015-B.

Analog BEEP enabled	EAPD Pin value <sup>1</sup>	Description
0	Forced to low when in D2 or D3	Follows description in HD Audio spec. External amplifier is shut down when pin or function group power state is D2 or D3 independent of value in EAPD bit.
1	Forced low in D2 or D3 unless port is enabled as output	Power state is ignored if port is enabled as output and port EAPD=1 to allow PC_Beep support in D2 and D3

**Table 11. EAPD Analog PC\_Beep behavior**

1. When pin is enabled as Open Drain or CMOS output.

AFG Power State	RESET#	Analog PC_BEEP	Port Power State	Pin Behavior
D0-D3	Asserted (Low)	-	-	Active low immediately after power on, otherwise the previous state is retained across FG and link reset events
D0	De-Asserted (High)	-	-	Active - Pin reflects EAPD bit unless held low by external source.
D1	De-Asserted (High)	-	D0-D1	Active - Pin reflects EAPD bit unless held low by external source.
D2	De-Asserted (High)	Disabled	D0-D2	Pin forced low to disable external amp
D2	De-Asserted (High)	Enabled	D0-D2	Active - EAPD Pin high if any port EAPD bit =1 and that port also enabled as output.
D3	De-Asserted (High)	Disabled	D0-D3	Pin forced low to disable external amp
D3	De-Asserted (High)	Enabled	D0-D3	Active - EAPD Pin high if any port EAPD bit=1 and that port also enabled as output.
D3cold	De-Asserted (High)	-	-	Pin forced low to disable external amp
D4	De-Asserted (High)	-	-	Pin forced low to disable external amp
D5	De-Asserted (High)	-	-	Pin Hi-Z (off)

**Table 12. EAPD Behavior**

Figure 3. HP EAPD Example to be replaced by single pin for internal amp

HP AUDIO CONTROL BLOCK DIAGRAM



Figure 4. EAPD implementation



2.13. Digital Microphone Support

The digital microphone interface permits connection of a digital microphone(s) to the CODEC via the DMIC0 and DMIC\_CLK 3-pin interface. The DMIC0 signals are inputs that carry individual channels of digital microphone data to the ADC. In the event that a single microphone is used, the data is ported to both ADC channels. This mode is selected using a vendor specific verb and the left time slot is copied to the ADC left and right inputs.

The DMIC\_CLK output is controllable from 4.704Mhz, 3.528Mhz, 2.352Mhz, 1.176Mhz and is synchronous to the internal master clock. The default frequency is 2.352Mhz.

The DMIC data input is reported as a stereo input pin widgets that incorporate a boost amplifier. The pin widgets are shown connected to the ADCs through the same multiplexors as the analog ports.

Although the internal implementation is different between the analog ports and the digital microphones, the functionality is the same. In most cases, the default values for the DMIC clock rate and data sample phase will be appropriate and an audio driver will be able to configure and use the digital microphones exactly like an analog microphone.

To conserve power, the analog portion of the ADC will be turned off if the D-mic input is selected. When switching from the digital microphone to an analog input to the ADC, the analog portion of the ADC will be brought back to a full power state and allowed to stabilize before switching from the digital microphone to the analog input. This should take less than 10mS.

DMIC pin widgets support port presence detect directly using SENSE-B input.

The codec supports the following digital microphone configurations:

Digital Mics	Data Sample	ADC Conn.	Notes
0	N/A	N/A	No Digital Microphones
1	Single Edge	0, or 1	Available on either DMIC_0 or DMIC_1 When using a microphone that supports multiplexed operation (2-mics can share a common data line), configure the microphone for "Left" and select mono operation using the vendor specific verb. "Left" D-mic data is used for ADC left and right channels.
2	Double Edge on either DMIC_0 or 1	0, or 1	Available on either DMIC_0 or DMIC_1, External logic required to support sampling on a single Digital Mic pin channel on rising edge and second Digital Mic right channel on falling edge of DMIC_CLK for those digital microphones that don't support alternative clock edge (multiplexed output) capability.

Table 13. Valid Digital Mic Configurations

Power State	DMIC Widget Enabled?	DMIC_CLK Output	DMIC_0	Notes
D0	Yes	Clock Capable	Input Capable	DMIC_CLK Output is Enabled when DMIC_0 Input Widget is Enabled. Otherwise, the DMIC_CLK remains Low
D1-D3	Yes	Clock Disabled	Input Disabled	DMIC_CLK is HIGH-Z with Weak Pull-down
D0-D3	No	Clock Disabled	Input Disabled	DMIC_CLK is HIGH-Z with Weak Pull-down
D4	-	Clock Disabled	Input Disabled	DMIC_CLK is HIGH-Z with Weak Pull-down
D5	-	Clock Disabled	Input Disabled	DMIC_CLK is HIGH-Z with Weak Pull-down

Table 14. DMIC\_CLK and DMIC\_0 Operation During Power States

Figure 5. Single Digital Microphone (data is ported to both left and right channels)



**Single Microphone not supporting multiplexed output.**

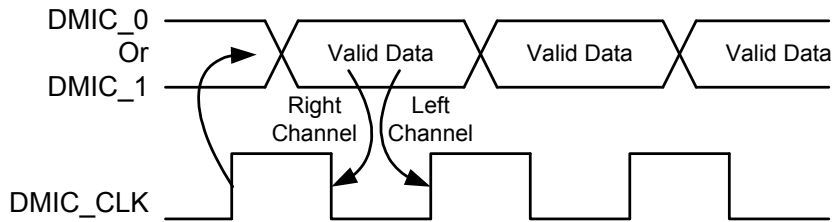

**Single "Left" Microphone, DMIC input set to mono input mode.**

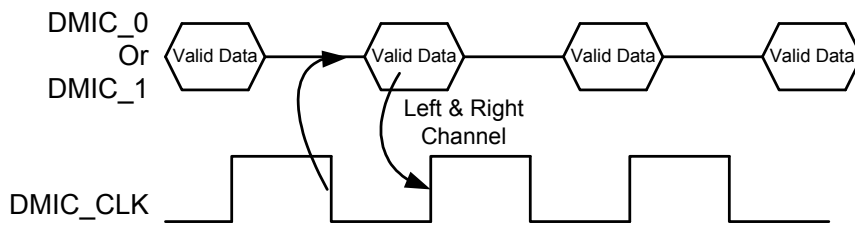
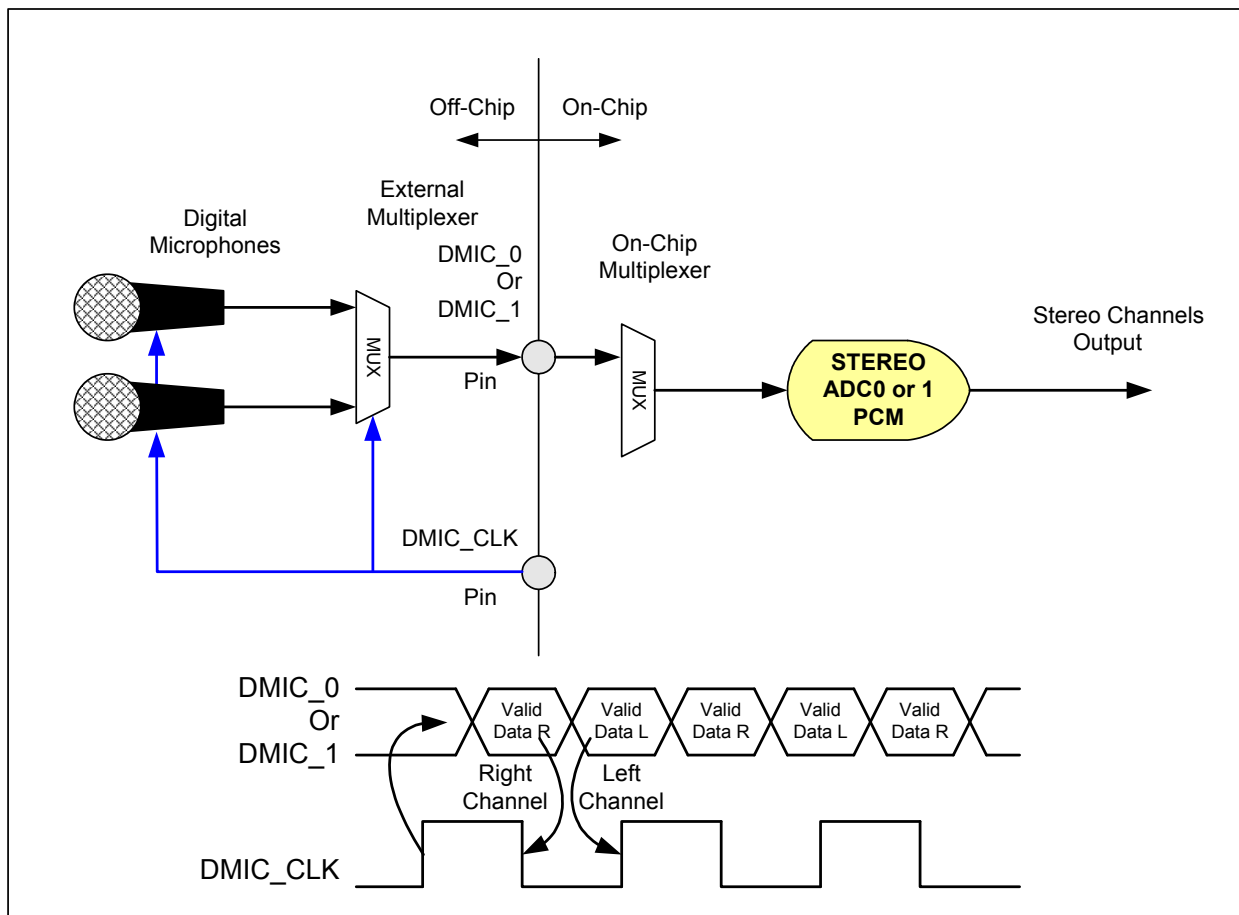

Figure 6. Stereo Digital Microphone Configuration



*Note: Some Digital Microphone Implementations support data on either edge, therefore, the external mux may not be required.*

### 2.14. Analog PC-Beep

The codec supports automatic routing of the PC\_Beep pin to Port A, Port B, and Port D outputs when the HD-Link is in reset.

When the link is active (not held in reset) Analog PC-Beep may be enabled manually. Analog PC\_Beep is mixed at the port and only ports enabled as outputs will pass PC\_Beep.

Beep activity monitoring is provided when the analog beep path is enabled and the CODEC or amplifier is in a low power state (D3).

The Analog PC Beep input is sampled for 500us every 1ms. If the beep input is high or low (>200mVpp) for at least 37% of that time, it is considered active. If it is active for less than 7.5% of



that time, it is possibly inactive. If no activity is detected for 64ms (128ms, 256ms and 512ms also selectable for the idle threshold), then beep is considered inactive.



Figure 7. Analog PC Beep Active

**Phase 1:** analog beep auto-routing phase in the period after application of DVDD, before the first rising edge of link reset.

Once Analog PCbeep is detected(BEEP\_PRESENCE=1) after 64ms delays (after POR (power on reset)), the Amplifier will be turned on(port\_pwd=0, port\_output\_en=1, there is a timing between these two signals) and analog\_beep\_en=1. If BEEP\_PRESENCE=0 for longer than the threshold time, the amplifiers will be turned off to save power and prevent unwanted system noise from being heard.

**Phase 2:** When not in phase 1

A. If analog beep function is disabled by driver.

Analog beep auto-detect will also be disabled.

B. If analog beep function is enabled by driver.

Once analog PCbeep is detected(BEEP\_PRESENCE=1), analog pc\_beep will be enabled

If in D0-D2, enabled simply means muting or un-muting beep to avoid hearing system noise on the beep input pin but it is acceptable to turn off port amplifiers if not currently used by DACs, mixer, or beep to save power.

If in D3, enabled means that the necessary amplifiers are turned on so that the beep signal may be heard on all ports configured as outputs (see analog pc-beep description section above)

All needed amplifiers are enabled until BEEP\_PRESENCE=0 for longer than the idle threshold

A flow chart of Analog PC Beep is below.

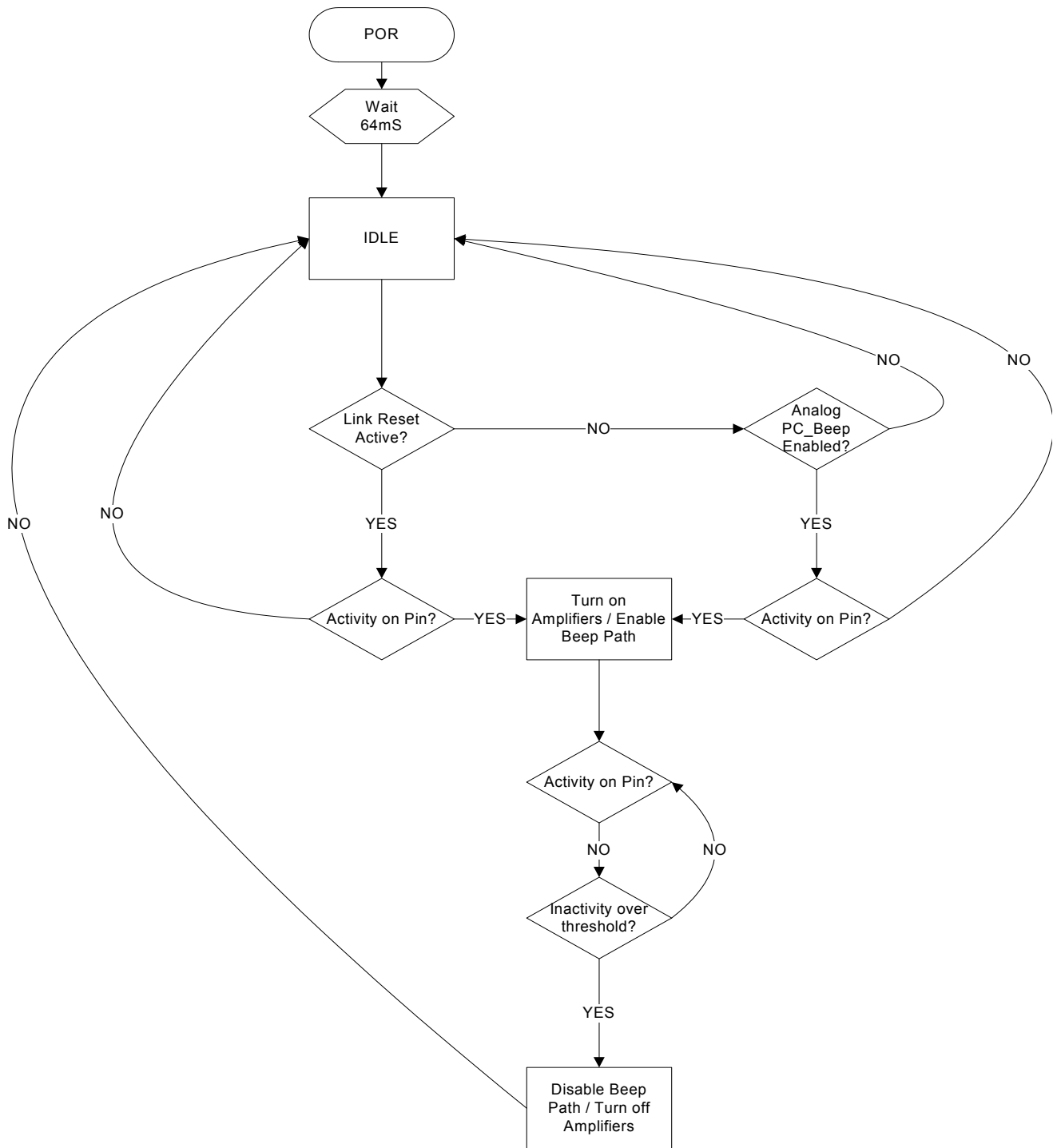

Figure 8. Analog PC Beep Flow chart

### 2.15. Digital PC-Beep

This block uses an 8-bit divider value to generate the PC beep from the 48kHz HD Audio Sync pulse. The digital PC\_Beep block generates the beep tone on all Pin Complexes that are currently configured as outputs. The HD Audio spec states that the beep tone frequency = (48kHz HD Audio

SYNC rate) / (4\*Divider), producing tones from 47 Hz to 12 kHz (logarithmic scale). Other audio sources are disabled when digital PC\_Beep is active.

It should be noted that digital PC Beep is disabled if the divider = 00h.

PC-Beep may be attenuated and distorted when the CODEC is in D3 depending on the load impedance seen by the output amplifier since all ports are in a low power state while in D3. Load impedances of 10K or larger can support full scale outputs but lower impedance loads will distort unless the output amplitude is reduced. Digital PC\_Beep requires a clock to operate and the CODEC will prevent the system from stopping the bus clock while in D3 by setting the Clock\_Stop\_OK bit to 0 to indicate that the part requires a clock.

## 2.16. Headphone Drivers

The codec implements both traditional and cap-less headphone outputs. The Microsoft Windows Logo Program allows up to the equivalent of 100ohms in series. However, an output level of +3dBV at the pin is required to support 300mV at the jack with a 32ohm load and 1V with a 320 ohm load. Microsoft allows device and system manufactures to limit output voltages to address EU safety requirements. (WLP 3.09 - please refer to the latest Windows Logo Program requirements from Microsoft.) The codec does not support power limiting.

Headphone performance will degrade if more than one port is driving a 32 ohm load.

## 2.17. BTL Amplifier

An integrated class-D stereo BTL amplifier is provided to directly drive 4 ohm speakers (2W @ 4.75V) or 8 ohm speakers (1W @ 4.75V). No external filter is needed for cable runs of 18" or less. An internal DC blocking filter prevents distortion when the audio source has DC content, and prevents unintentional power consumption when pausing audio playback. The amplifier may be controlled using the EAPD pin (see EAPD section.)

Using a vendor specific verb, the BTL amplifier may be configured to support a mono speaker connected to the L +/- pins. In this mode, the Left and Right audio is mixed and sent to the left output only. The right channel is turned off to conserve power.

Maximum gain for the BTL amplifier is programmable. The following 4 gain settings relative to a nominal line output are desired: +6.5dB, +9.5dB, +14.5dB, +16.5dB. Absolute gain may vary and the suggested accuracy is +/-1.5dB.

This gain is exposed in a vendor specific widget and is intended to mimic the pin programmable gain implemented in discrete BTL amplifiers commonly used in notebook computers.

The BTL amplifier includes thermal management circuitry. When the CODEC reaches a temperature of about 140 degrees, the output amplitude of the BTL amp is gradually lowered until the temperature falls below 140. All other functions will remain active if the BTL amplifier is shut down due to die temperature.

## 2.18. BTL Amplifier High-Pass Filter

For mobile applications, speakers are often incapable of reproducing low frequency audio and unable to handle the maximum output power of the BTL amplifier. A high-pass filter is implemented in the BTL output path to reduce the amount of low frequency energy reaching speakers attached to the BTL amplifier. This can prevent speaker failure.

### 2.18.1. Filter Description

The high-pass filter is derived from the common biquadratic filter and provides a 12dB/octave roll-off. The filter may be programmed for a -3dB response at: 100Hz, 200Hz, 300Hz, 400Hz, 500Hz, 750Hz, 1KHz, or 2KHz. The high pass filter is enabled by default with a cut-off frequency of 300Hz. The filter may be bypassed using the associated verb (processing state verb).

The analog PC\_Beep input is not affected by the digital high-pass filter. To ensure that the speakers attached to the BTL amplifier are not harmed by low frequency audio entering the PC\_Beep input, an external filter must be implemented. Fortunately, it is common practice to implement an attenuation circuit and DC blocking capacitor at the PC\_Beep input. This attenuator/filter is easily adjusted to restrict low frequency audio. The easiest approach is to reduce the value of the DC blocking capacitor but other approaches are equally effective.

## 2.19. EQ

There are 5 bands of parametric EQ (bi-quad) per channel. Due to the flexibility of the bi-quad implementation, each filter band may be configured as a high-pass, low-pass, band-pass, high shelving, low shelving, or other function.

Each band has an independent set of coefficients. A bi-quad filter has 6 coefficients. One coefficient is normalized to 1 and 5 are programmed into the core. Each band supports up to +15dB boost or up to -36dB cut.

## 2.20. Combo Jack Detection

4 conductor (combo) jacks are becoming popular. In the most common implementation the 4 conductor plug has the same mechanical dimensions as a 3 conductor 3.5mm plug but the sleeve portion has been split into two segments: S1 and S2. When a 4-conductor plug (headset) is inserted into the jack T (Tip) = Left headphone audio, R (Ring) = Right headphone audio, S1 (First half of sleeve) = microphone input, and S2 (Second half of sleeve) = return (GND). When a 3-conductor plug (headphones) is inserted into the jack; T=Left audio, R=Right audio, S1=GND, S2=GND. By monitoring the S1 connection to see if it is shorted to ground, we can distinguish between headsets and headphones. Please note that analog microphone plugs (3-conductor-Lmic/Rmic/GND) and optical SPDIF plugs can not be supported using this implementation.

Figure 9. Combo Jack



Plug insertion is reported on the headphone port using the switch integrated into the jack.

The internal circuit monitors the voltage at the jack to determine if a low impedance load is present.

Detection of a microphone is not reported unless plug insertion is also detected.

## 2.21. GPIO

### 2.21.1. GPIO Pin mapping and shared functions

GPIO #	Pin	Supply	GPIO/O	GPI	GPO	VrefOut	DMIC	VOL	Pull Up	Pull Down
0	38	DVDD	YES				IN			50K
1	2	DVDD	YES				CLK			50K
2	3	DVDD	YES				IN			50K
3	38	DVDD	YES							50K
4	20	AVDD	YES			YES				50K

### 2.21.2. Digital Microphone/GPIO Selection

Functions are available on the GPIO0 pin. To determine which function is enabled, the order of precedence is followed:

1. If the GPIOs are enabled, they override Digital Mics
2. If the GPIOs are not enabled through the AFG, then at reset, the pin is pulled low by an internal pull-down resistor.
3. If the port is enabled as an input, the digital microphones will be used.
4. In the event that the port is enabled as an input and an output, the port will be an output and the Digital Mic path will be mute.

### 2.21.3. Digital Microphone/GPIO Selection

2 functions are available on the DMIC\_CLK/GPIO1 (pin 2) and the DMIC\_0/GPIO2 (pin 4) pins. To determine which function is enabled, the order of precedence is followed:

1. If GPIOs are not enabled through the AFG, then at reset, pins 2 and 4 are pulled low by an internal pull-down resistor.
2. If the GPIO 1 is enabled, the 2 DMIC pins become mute (unless programmed for GPIO use) and pin 2 becomes GPIO with an internal pull-down.
3. If GPIO2 is enabled through the AFG, pin 4 becomes a GPIO and is pulled low by an internal pull-down resistor.
4. If the port is enabled as an input, the digital microphones will be used.
5. If the port is not enabled as an input or if the pin is configured as a GPIO, the digital microphone path will be mute.

## 2.22. HD Audio HDA015-B support

The codec provides complete support for the HDA015-B specification (now DCN) building on the support already present in previous products. HDA015-B features supported are:

1. Persistence of many configuration options through bus and function group reset.
2. The ability to support port presence detect in D3 even when the HD Audio bus is in a low power state (no clock.)
3. Fast resume times from low power states: 1ms D1 to D0, 2ms D2 to D0, 10mS D3 to D0.

4. Notification if persistent register settings have been unexpectedly reset.

### **2.23. Digital Core Voltage Regulator**

The digital core operates from a 1.8V (10%) supply voltage. Many systems require that the CODEC use a single 3.3V digital supply, so an integrated regulator is included on die. The regulator uses pin 9, DVDD, as its voltage source. The output of the LDO is connected to pin 1 and the digital core. A 10uF capacitor must be placed on pin 1 for proper load regulation and regulator stability.

The digital core voltage regulator is only dependent on DVDD. DVDDIO may be either 3.3 or 1.5V and may precede or follow DVDD in sequence. The CODEC digital logic and I/O (unless referenced to AVDD) will operate in the absence of AVDD. DVDD and AVDD supply sequencing for the application of power and the removal of power is neither defined nor guaranteed. It is common for desktop systems to supply AVDD from the system standby supply and the CODEC will tolerate, indefinitely, the condition where AVDD is active but DVDD and DVDDIO are inactive.

## 2.24. Aux Audio Support

The CODEC supports an auxiliary audio mode where analog audio is supported by default after power is supplied with the HD Audio bus disabled. In this mode, an analog input is routed to one of several output ports depending on jack presence detection.

In addition to shutting of the CODEC BTL and headphone amplifiers when the dock output jack is used, the BTL amplifier will be disabled when the headphone jacks are used, and the headphone amplifiers will be disabled when not in use.

### 2.24.1. General conditions in Aux Audio Mode:

HD Audio Link is off (RST# is 0, active, and BitClk is 0, inactive. CODEC does not need to monitor BitClk to enter/exit this mode but must not depend on BitClk to operate.) (Part will enter Aux Audio Mode immediately on application of power if Aux Audio Mode is enabled as default.)

OR

HD Audio CODEC function group power state is set to D3cold and Aux Audio Mode is enabled. (Device enters immediately on transition to D3cold and remains in Aux mode until a double AFG reset event is received or until the next rising edge of RST#)

- HD Audio CODEC analog and digital supplies are active.
- Port A connects to the system microphone jack.
- Port B connects to the system headphone jack.
- Port C is not used
- Port D connects to the internal speakers.
- Port E is connected to the dock Line Out jack/AUX Audio out (it is an output port)
- Port F is connected to the dock Mic Input jack/AUX Audio In (it is an input port)
- The digital microphone clock is generated by the CODEC. The DMIC data is converted to PCM and sent to the Aux Audio Module through the Aux Out port.
- The System microphone jack (Port A) is available to the auxiliary audio subsystem. Vref\_Out will be enabled when the system Mic is plugged in.
- EAPD is used to control the power state of the mixer, BTL amplifier, and headphone amplifiers. The amplifiers are off if EAPD is held low.
- Internal circuitry will delay enabling (change power state, un-mute, etc.) the output amplifiers a sufficient amount of time after the application of power or EAPD=1 to prevent pops.
- Internal circuitry will orchestrate power down (EAPD = 0) to prevent pops.
- EAPD must be forced low before removing power.
- No special Dock signal present for the CODEC. Only port presence detect for the dock Line Out (port E) is used.
- ECR15b operation does not presents a problem. The CODEC will not enter Aux Audio mode unless the function group power state is set to D3cold prior to putting the HD Audio interface into reset (controller D3.)To prevent undesirable behavior (pops, etc.) the bus must not be placed into reset with the clock stopped unless EAPD is forced low or D3cold has been set. The Enable bit in the Aux Audio vendor specific verb is provided so firmware or other software can disable Aux Audio support. The default value of this bit is determined by a bond option and may be determined by reading the device ID. This bit only returns to its default value when a power on reset event is generated or when programmed to that value by software.

2.24.2. Entering Aux Audio Mode

Enter AUX mode under two conditions, refer to figure below:

- When DVDD is powered-up, the value of AUX\_enable register is “enabled” (one), and before link reset is de-asserted (pull high).
- If AUX\_enable is “enabled” (one) and the Power state is D3cold then chip will also enter AUX mode but the Clock\_Stop\_OK flag is not required (set to 1 if convenient.). (Note that the part will enter Aux mode immediately upon transition to D3cold. It is possible to return to normal operation by issuing a double AFG reset if the link is still active.)

*Note: At that time, Force Portsense and BTL Amp on when we enter link reset if the AuxAudio bit is set. If the AuxAudio bit is not set (by bond option or software) then we will not enter Aux Audio Mode-Portsense and BTL Amp will remain off.*

Port F (“dock microphone”) input is routed to Port D (“internal speakers”), Ports B (system head-phone port), and Port E (“dock Line Out”) directly. The analog mixer is disabled to reduce power consumption.

Figure 10. Switching between Normal and Aux Audio Modes

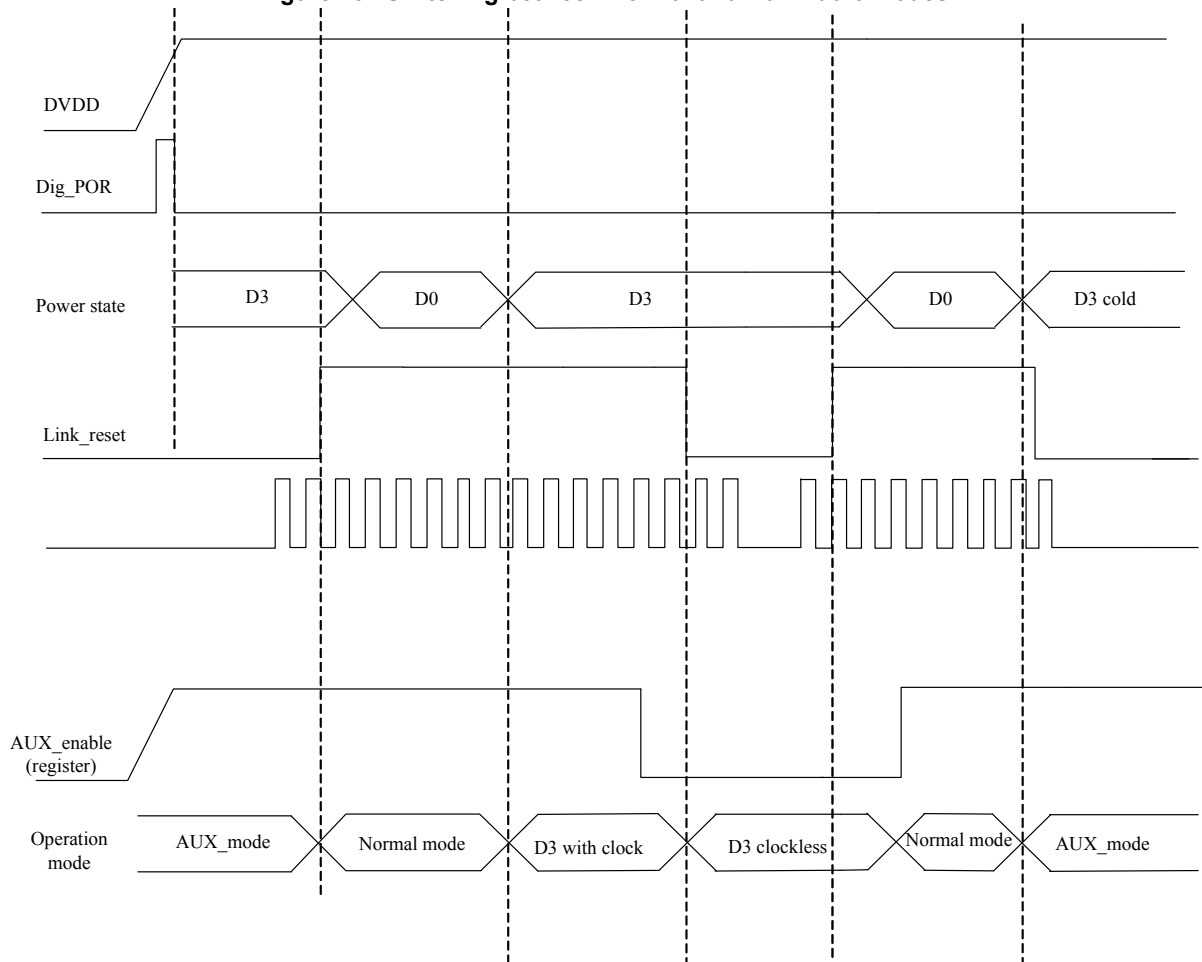



### 2.24.3. "Playback Path" Port Behavior (Analog I/O)

Port F ("dock microphone") input is routed to Port D ("internal speakers") and Port B (system headphone port). The analog mixer is disabled to reduce power consumption.

#### 2.24.4. When Port E presence detect = 0

- Presence detect for Port E = 0 (nothing plugged in)
- Port F, the "dock microphone", input is routed to Port B, or D when that port is active
- The power supply (charge pump) for B will be inactive if B is not in use.
- If Port B is not in use (port presence detect = 0), Port D, internal speakers, will be active and port B will be inactive.
- EAPD must not be forced low due to the dock being absent or high when a dock is present. EAPD is used to indicate if AUX Audio Mode is in use.

#### 2.24.5. When Port E presence detect = 1

- Presence detect for Port E = 1 (something plugged in)
- Port D is disabled
- If Port B is in use (port presence detect = 1), that port will be enabled and output the audio entering Port F
- The power supply for port B will be active if port B is in use.
- If Port B is not in use (port presence detect = 0), port B will be inactive and the audio on Aux\_In will be mixed with the audio from the Secondary Audio input and routed to Port E, the dock headphone jack.
- EAPD must not be forced low due to the dock being absent or high when a dock is present. EAPD is used to indicate if AUX Audio Mode is in use.

EAPD (pin)	Aux Support Enable <sup>1</sup>	Port E detect	Port B detect	Port A, C, F, DMIC detect	Port D behavior	Port B behavior	Port E behavior
0	NA	NA	NA	NA	disabled	disabled	disabled (mute)
1	0	NA	NA	NA	Widget controlled	Widget controlled	Widget controlled
1	1	0	0	NA	enabled (F to D)	disabled	disabled (mute)
1	1	0	1	NA	disabled	enabled (F to B)	disabled (mute)
1	1	1	0	NA	disabled	disabled	enabled Aux+Secondary
1	1	1	1	NA	disabled	enabled (F to B)	disabled (mute)

1.default value for Aux Audio Enable is determined by bond option.

2.24.6. SYSTEM DIAGRAMS (Analog I/O)

Figure 11. Aux Audio Playback When Nothing Plugged In (or System is not Docked)

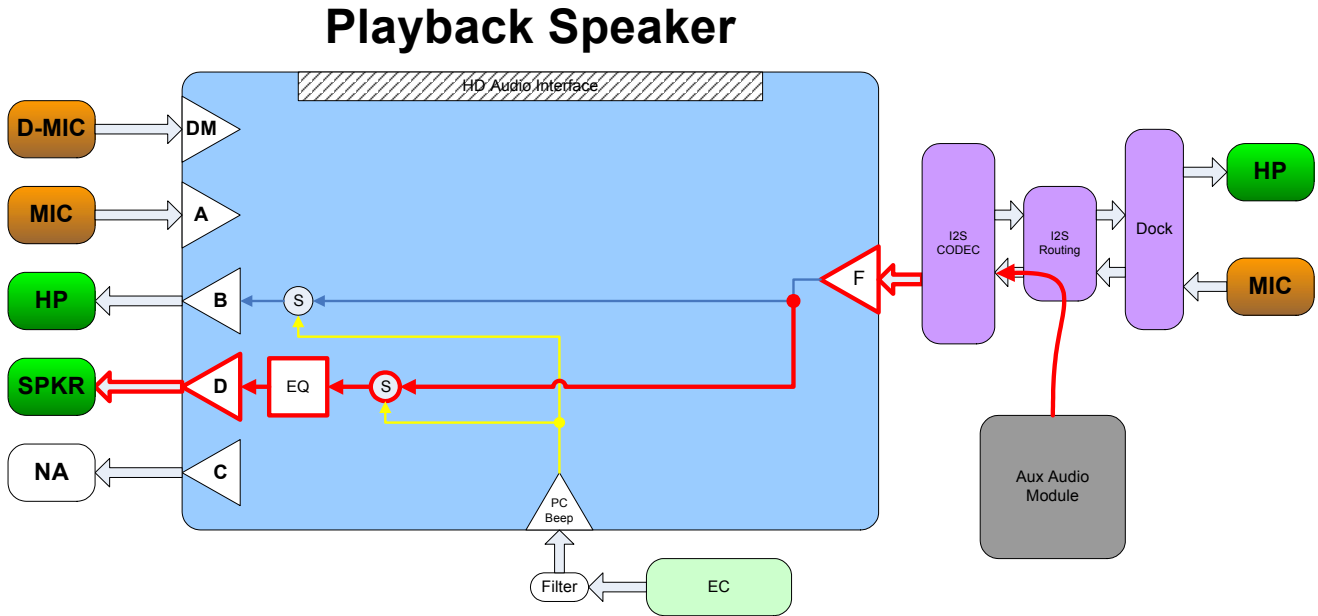

Figure 12. Aux Audio Playback When System Headphones are Plugged In

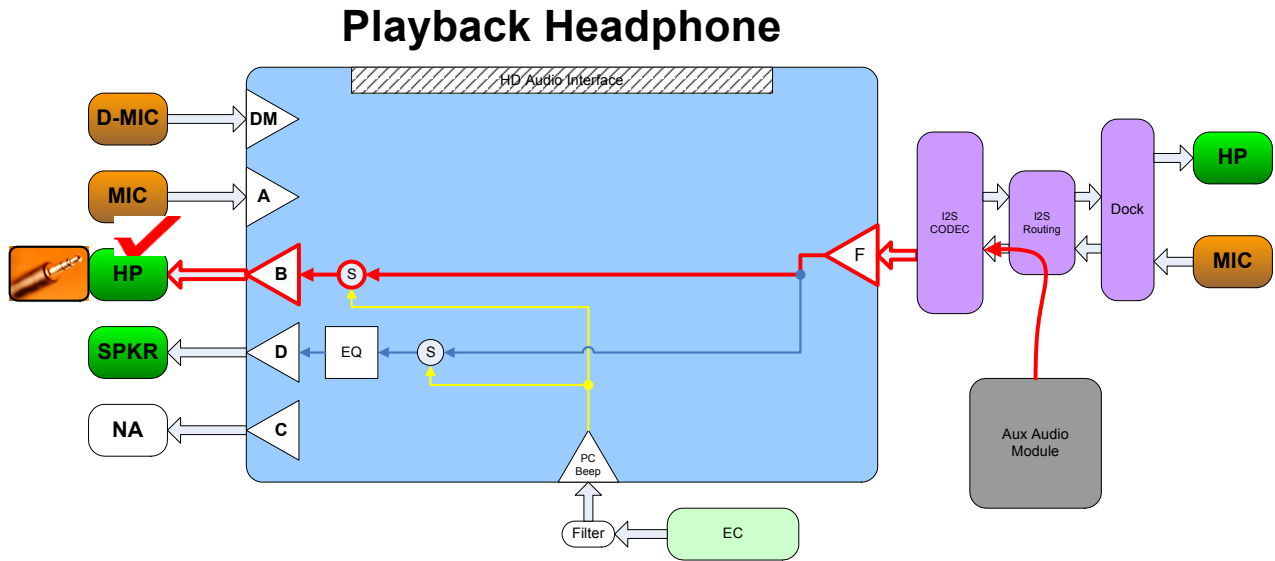

Figure 13. Aux Audio Playback when the System is Docked and Headphones are Plugged In



### 2.24.7. EAPD

Since the Aux Audio mode overrides the default behavior but not the actual port settings when in reset, the logical state of the EAPD pin must be overridden as well. When Aux Audio mode is enabled and the part is in reset as described above, the logical state of EAPD will be 1 (External Amplifier Powered Up) unless held low by an external circuit. This ensures that audio pass-thru and analog PC\_Beep will be supported.

### 2.24.8. Analog PC\_Beep

Analog PC\_Beep is supported in Aux Audio mode. By default, analog PC\_Beep is disabled but may be enabled due to Beep pass-thru support in reset (see the PC\_Beep section). If the CODEC is programmed to enable analog PC\_Beep and Aux Audio mode is enabled, the next time reset is asserted, the analog PC\_Beep pin will be mixed at each of the active outputs.

### 2.24.9. Class-D BTL Issues

While in Aux Audio mode the HD Audio bus clock (BitClk) is not available. The Class-D controller requires a very high speed clock to operate and an internal clock must be provided. In Aux Audio mode, the actual frequency used by the Class-D controller and its associated ADC will not be exact since an external reference will not be available. The performance characteristics in Aux Audio Mode will be degraded compared to the normal operating mode characteristics specified elsewhere in this document.

### 2.24.10. Firmware/Software Requirements:

The reconfiguration outlined in this chapter is autonomous (without the help of firmware or OS driver.)

This autonomous mode does not interfere with normal operation.

If it is desirable to stop the HD Audio bus while the CODEC is in D3 under OS control per DCN HDA015-B, no action is required. The CODEC will not enter Aux Audio Mode unless placed in D3cold.

## **2.25. Microphone Mute Input**

**Available on silicon revision WB and beyond.**

The 92HD99 supports a microphone mute input. An external switch or other circuit may directly mute the CODEC without relying on software control. This is a most helpful feature for allowing the end user to conveniently enforce privacy since it bypasses the record gain/mute functions typically controlled by software. While recording is muted, any active stream will receive digital silence.

### 3. CHARACTERISTICS

#### 3.1. Electrical Specifications

##### 3.1.1. Absolute Maximum Ratings

Stresses above the ratings listed below can cause permanent damage to the 92HD99. These ratings, which are standard values for TSI commercially rated parts, are stress ratings only. Functional operation of the device at these or any other conditions above those indicated in the operational sections of the specifications is not implied. Exposure to absolute maximum rating conditions for extended periods can affect product reliability. Electrical parameters are guaranteed only over the recommended operating temperature range.

Item	Pin	Maximum Rating
Analog maximum supply voltage	AVdd	6 Volts
Digital maximum supply voltage	DVdd	5.5 Volts
	PVdd	6 Volts
VREFOUT output current		5 mA
Voltage on any pin relative to ground		Vss - 0.3 V to Vdd + 0.3 V
Operating temperature		0 °C to +70 °C -40 °C to +85°C (INDUSTRIAL TEMP, see part number list)
Storage temperature		-55 °C to +125 °C
Soldering temperature		Soldering temperature information for all available in the package section of this datasheet.

Table 15. Electrical Specification: Maximum Ratings

##### 3.1.2. Recommended Operating Conditions

Parameter		Min.	Typ.	Max.	Units
Power Supplies	DVDD_Core	1.6	1.8	1.98	V
	DVDD_IO (3.3V signaling)	3.135	3.3	3.465	V
	DVDD_IO (1.5V signaling)	1.418	1.5	1.583	V
Power Supply Voltage	Digital - 3.3 V	3.135	3.3	3.465	V
	Analog - 5 V	4.75	5	5.25	V
Ambient Operating Temperature		0		+70	°C
Case Temperature	T <sub>case</sub>			+95	°C
	T <sub>case</sub> Industrial			+110	°C

Table 16. Recommended Operating Conditions

**ESD:** The 92HD99 is an ESD (electrostatic discharge) sensitive device. The human body and test equipment can accumulate and discharge electrostatic charges up to 4000 Volts without detection. Even though the 92HD99 implements internal ESD protection circuitry, proper ESD precautions should be followed to avoid damaging the functionality or performance.

### 3.2. 92HD99 Analog Performance Characteristics

( $T_{\text{ambient}} = 25\text{ }^{\circ}\text{C}$ ,  $AV_{\text{dd}} = 4.75\text{V}$  (4.5-5.25V) or  $3.3\text{V} \pm 5\%$ ,  $DV_{\text{dd}} = 3.3\text{V} \pm 5\%$  or  $1.8\text{V} \pm 10\%$ ,  $AV_{\text{ss}}=DV_{\text{ss}}=0\text{V}$ ; 20Hz to 20KHz swept sinusoidal input; Sample Frequency = 48 kHz; 0dB FS = 1Vrms for  $AV_{\text{dd}} = 4.75\text{V}$  and 0.71Vrms for  $AV_{\text{dd}} = 3.3\text{V}$ , 10K $\Omega$ //50pF load, Testbench Characterization BW: 20 Hz – 20 kHz, 0 dB settings on all gain stages)

Parameter	Conditions	Min	Typ	Max	Unit
<b>Digital to Analog Converters</b>					
Resolution			24		Bits
Dynamic Range <sup>1</sup> : PCM to All Analog Outputs	-60dB FS signal level, Analog Mixer disabled		98		dB
SNR <sup>2</sup> - DAC to All Line-Out Ports	Analog Mixer Disabled, PCM data		98		dB
THD+N <sup>3</sup> - DAC to All Line-Out Ports	Analog Mixer Disabled, -3dB FS Signal, PCM data		89		dBr
SNR <sup>2</sup> - DAC to All Headphone Ports	Analog Mixer Disabled, 10K $\Omega$ load, PCM data		98		dB
THD+N <sup>3</sup> - DAC to All Headphone Ports	Analog Mixer Disabled, -3dB FS Signal, 10K $\Omega$ load, PCM data		87		dBr
SNR <sup>2</sup> - DAC to All Headphone Ports	Analog Mixer Disabled, 32 $\Omega$ load, PCM data		98		dB
THD+N <sup>3</sup> - DAC to All Headphone Ports	Analog Mixer Disabled, -3dB FS Signal, 32 $\Omega$ load, PCM data		73		dBr
Any Analog Input (ADC) to DAC Crosstalk	10KHz Signal Frequency. 0dBV signal applied to ADC, DACs idle, ports enabled as output.	-65	-	-	dB
Any Analog Input (ADC) to DAC Crosstalk	1KHz Signal Frequency. see above	-65	-	-	dB
DAC L/R crosstalk	DAC to LO or HP 20-15KHz into 10K $\Omega$ load	70	73		dB
DAC L/R crosstalk	DAC to HP 20-15KHz into 32 $\Omega$ load	65	68		dB
Gain Error	Analog Mixer Disabled			0.5	dB
Interchannel Gain Mismatch	Analog Mixer Disabled			0.5	dB
D/A Digital Filter Pass Band <sup>4</sup>		20	-	21,000	Hz
D/A Digital Filter Pass Band Ripple <sup>5</sup>				0.125	+/- dB
D/A Digital Filter Transition Band		21,000	-	31,000	Hz
D/A Digital Filter Stop Band		31,000	-	-	Hz
D/A Digital Filter Stop Band Rejection <sup>6</sup>		-100	-	-	dB
D/A Out-of-Band Rejection <sup>7</sup>		-55	-	-	dB
Group Delay (48KHz sample rate)		-	-	1	ms
Attenuation, Gain Step Size DIGITAL		-	0.75	-	dB

Table 17. 92HD99 Analog Performance Characteristics

# 92HD99

## SINGLE CHIP PC AUDIO SYSTEM, CODEC+SPEAKER AMPLIFIER+CAPLESS HP+LDO

Parameter	Conditions	Min	Typ	Max	Unit
DAC Offset Voltage		-	10	20	mV
Deviation from Linear Phase		-	1	10	deg.
<b>Analog Outputs</b>					
Full Scale All Mono/Line-Outs	DAC PCM Data	1.00	-	-	Vrms
Full Scale All Mono/Line-Outs	DAC PCM Data	2.83	-	-	Vp-p
All Headphone Capable Outputs	32Ω load	40	60	-	mW (peak)
Amplifier output impedance	Mono/Line Outputs Headphone Outputs	150 0.1			Ohms
External load Capacitance	Mono/Line Outputs Headphone Outputs		220		pF
<b>Analog inputs</b>					
Full Scale Input Voltage	0dB Boost @4.75V (input voltage required for 0dB FS output)	1.05	-	-	Vrms
All Analog Inputs with boost	10dB Boost	0.320	-	-	Vrms
All Analog Inputs with boost	20dB Boost	0.105	-	-	Vrms
All Analog Inputs with boost	30dB Boost	0.032	-	-	Vrms
Boost Gain Accuracy		-2		2	dB
Input Impedance		-	50	-	KΩ
Input Capacitance		-	15	-	pF
<b>Analog Mixer</b>					
Dynamic Range: PCM to All Analog Outputs	-60dB FS signal level Analog Beep enabled all other mixer inputs mute		95		dB
SNR <sup>2</sup> - All Line-Inputs to all Line Outputs	All inputs unmuted, single line input driven by ATE.		90		dB
THD+N <sup>3</sup> - All Line-Inputs to all Line Outputs	0dB Full Scale Input on one input, all others silent.		83		dBr
SNR <sup>2</sup> - DAC to All Ports	Analog Mixer Enabled, PCM data, all others inputs mute.		98		dB
THD+N <sup>3</sup> - DAC to All Ports	Analog Mixer Enabled, 0dB FS Signal, PCM data, all others inputs unmute/silent		85		dBr
Attenuation, Gain Step Size ANALOG		-	1.5	-	dB
<b>Analog to Digital Converter</b>					
Resolution			24		Bits
Full Scale Input Voltage	0dB Boost (input voltage required to generate 0dBFS per AES 17)	1.05			
Dynamic Range <sup>1</sup> , All Analog Inputs to A/D	High Pass Filter Enabled, -60dB FS, No boost		94		dB
Full Scale Input Voltage	20dB Boost (input voltage required to generate 0dBFS per AES 17)	0.105			
Dynamic Range <sup>1</sup> , All Analog Inputs to A/D	20dB Boost High Pass Filter Enabled, -60dB FS		90		dB
THD+N <sup>3</sup> All Analog Inputs to A/D	High Pass Filter enabled, -3dB FS signal level		83		dB

Table 17. 92HD99 Analog Performance Characteristics

# 92HD99

## SINGLE CHIP PC AUDIO SYSTEM, CODEC+SPEAKER AMPLIFIER+CAPLESS HP+LDO

Parameter	Conditions	Min	Typ	Max	Unit
THD+N <sup>3</sup> All Analog Inputs to A/D	20dB Boost, High Pass Filter enabled, -3dB FS signal level		80		dB
Analog Frequency Response <sup>8</sup>		10	-	30,000	Hz
A/D Digital Filter Pass Band <sup>4</sup>		20	-	21,000	Hz
A/D Digital Filter Pass Band Ripple <sup>5</sup>				0.1	+/- dB
A/D Digital Filter Transition Band		21,000	-	31,000	Hz
A/D Digital Filter Stop Band		31,000	-	-	Hz
A/D Digital Filter Stop Band Rejection <sup>6</sup>		-100	-	-	dB
Group Delay	48 KHz sample rate	-	-	1	ms
Any unselected analog Input to ADC Crosstalk	10KHz Signal Frequency	-65	-	-	dB
Any unselected analog Input to ADC Crosstalk	1KHz Signal Frequency	-65	-	-	dB
ADC L/R crosstalk	Any selected input to ADC 20-15Khz	-65			dB
DAC to ADC crosstalk	DAC output 0dBFS. All outputs loaded. Input to ADC open. 20-15Khz	-65			dB
Spurious Tone Rejection <sup>9</sup>		-	-100	-	dB
Attenuation, Gain Step Size (analog)		-	1.5	-	dB
Interchannel Gain Mismatch ADC		-	-	0.5	dB
<b>Power Supply</b>					
Power Supply Rejection Ratio	10kHz	-	-60	-	dB
Power Supply Rejection Ratio	1kHz	-	-70	-	dB
D0 Didd <sup>10</sup>	3.3V		25		mA
D0 Aidd <sup>10</sup>	5V		66		mA
D0 Didd <sup>11</sup>	3.3V		17		mA
D0 Aidd <sup>11</sup>	5V		54		mA
D1 Didd <sup>12</sup>	3.3V		10		mA
D1 Aidd <sup>12</sup>	5V		30		mA
D2 Didd	3.3V		8		mA
D2 Aidd	5V		7		mA
D3 (Beep enabled) Didd <sup>13</sup>	3.3V		2		mA
D3 (Beep enabled) Aidd <sup>13</sup>	5V		6		mA
D3 Didd <sup>13</sup>	3.3V		2		mA
D3 Aidd <sup>13</sup>	5V		4		mA
D3cold Didd <sup>13</sup>	3.3V		1.3		mA
D3cold Aidd <sup>13</sup>	5V		3.5		mA
Vendor D4 Didd	3.3V		1.1		mA
Vendor D4 Aidd	5V		3.5		mA

Table 17. 92HD99 Analog Performance Characteristics



# 92HD99

## SINGLE CHIP PC AUDIO SYSTEM, CODEC+SPEAKER AMPLIFIER+CAPLESS HP+LDO

Parameter	Conditions	Min	Typ	Max	Unit
Vendor D5 Didd	3.3V		1		mA
Vendor D5 Aidd	5V		0.3		mA
<b>Voltage Reference Outputs</b>					
VREFOut <sup>14</sup>		-	0.5 X AVdd	-	V
VREFOut Drive			1.6		mA
VREFILT (VAG)			0.45 X AVdd		V
<b>Phased Locked Loop</b>					
PLL lock time			96	200	usec
PLL (or HD Audio Bit CLK) 24MHz clock jitter			150	500	psec
<b>ESD / Latchup</b>					
IEC1000-4-2		1			Level
JESD22-A114-B		2			Class
JESD22-C101		4			Class

**Table 17. 92HD99 Analog Performance Characteristics**

1. Dynamic Range is the ratio of the full scale signal to the noise output with a -60dBFS signal as defined in AES17 as SNR in the presence of signal and outlined in AES6id, measured "A weighted" over 20 Hz to 20 kHz bandwidth
2. Ratio of Full Scale signal to idle channel noise output is measured "A weighted" over a 20 Hz to a 20 kHz bandwidth. (AES17-1991 Idle Channel Noise or EIAJ CP-307 Signal-to-noise Ratio).
3. THD+N ratio as defined in AES17 and outlined in AES6id, non-weighted, over 20 Hz to 20 kHz bandwidth. Results at the jack are dependent on external components and will likely be 1 - 2dB worse.
4. Peak-to-Peak Ripple over Passband meets  $\pm 0.125$ dB limits, 48 kHz or 44.1 kHz Sample Frequency. 1dB limit.
5. Peak-to-Peak Ripple over Passband meets  $\pm 0.125$ dB limits, 48 kHz or 44.1 kHz Sample Frequency. 1dB limit.
6. Stop Band rejection determines filter requirements. Out-of-Band rejection determines audible noise.
7. The integrated Out-of-Band noise generated by the DAC process, during normal PCM audio playback, over a bandwidth 28.8 to 100 kHz, with respect to a 1 Vrms DAC output.
8.  $\pm 1$ dB limits for Line Output & 0 dB gain, at -20dBV
9. Spurious tone rejection is tested with ADC dither enabled and compared to ADC performance without dither.
10. All functions/converters active, pin complexes enabled, two FDX streams, line (10Kohm) loads. Add 24mA analog current per stereo 32 ohm headphone.
11. One stereo DAC and corresponding pin widgets enabled (playback mode)
12. Mixer enabled
13. Idle measurement D3 set for minimum clicks/pops (biases and min. amps. on)
14. Can be set to 0.5 or 0.8 AVdd.

### 3.3. Class-D BTL Amplifier Performance

Parameter	Min	Typ	Max	Unit
Output Power (BTL 4 ohm, 5V, <1% THD+N)	2			W
Output Power (BTL 4 ohm, 5V, <10% THD+N)		3		W
Amplifier Efficiency $\eta$ (4 $\Omega$ , 5V, 2W)		86		%
THD+N (BTL 4 $\Omega$ , 5V, FS)			1	%
THD+N (BTL 4 $\Omega$ , 5V, -3dBFS)		0.3		%
Frequency Response	20	-	20K	Hz
PWM frequency		352.8		KHz
Output voltage noise (4 $\Omega$ , 5V)		65		$\mu$ V
Idle current		3.6		mA
Shutdown current		.2		mA

Table 18. Class-D BTL Amplifier Performance

### 3.4. Capless Headphone Supply Characteristics

Parameter	Min	Typ	Max	Unit
LDO idle current		1	2	mA
Capless Headphone Amp idle current		2	3	mA
Charge Pump idle current		4	6	mA
Charge Pump shutdown time		1		mS
Charge Pump start-up time		10		mS
Frequency		384		KHz
C1/C2 cap value		2.2		uF

Table 19. Capless Headphone Supply

### 3.5. AC Timing Specs

#### 3.5.1. HD Audio Bus Timing

Parameter	Definition	Symbol	Min	Typ	Max	Units
BCLK Frequency	Average BCLK frequency		23.9976	24.0	24.0024	Mhz
BCLK Period	Period of BCLK including jitter	T <sub>cyc</sub>	41.163	41.67	42.171	ns
BCLK High Phase	High phase of BCLK	T <sub>high</sub>	17.5		24.16	ns
BCLK Low Phase	Low phase of BCLK	T <sub>low</sub>	17.5		24.16	ns
BCLK jitter	BCLK jitter			150	500	ps
SDI delay	Time after rising edge of BCLK that SDI becomes valid	T <sub>tco</sub>	3		11	ns
SDO setup	Setup for SDO at both rising and falling edges of BCLK	T <sub>su</sub>	5			ns
SDO hold	Hold for SDO at both rising and falling edges of BCLK	T <sub>h</sub>	5			ns

Table 20. HD Audio Bus Timing

Figure 14. HD Audio Bus Timing



### 3.5.2. Digital Microphone Timing

Parameter	Definition	Symbol	Min	Typ	Max	Units
DMIC_CLK Frequency	Average DMIC_CLK frequency		1.176	2.352	4.704	MHz
DMIC_CLK Period	Period of DMIC_CLK	Tdmic_cyc	850.34	425.17	212.59	ns
DMIC_CLK jitter	DMIC_CLK jitter				5000	ps
DMIC Data setup	Setup for the microphone data at both rising and falling edges of DMIC_CLK	Tdmic_su	5			ns
DMIC Data hold	Hold for the microphone data at both rising and falling edges of DMIC_CLK	Tdmic_h	5			ns

Table 21. Digital Mic timing

### 3.5.3. GPIO Characteristics

Parameter	Definition	Symbol	Min	Typ	Max	Units
Input High Voltage <sup>1</sup>	input level at or above which a 1 is reliably recorded	Vih	0.6 x VDD			V
Input Low Voltage <sup>1</sup>	input level at or below which a 0 is reliably recorded. VDD may be DVDD or AVDD	Vil			0.35 x VDD	V
Output High Voltage	iout = 4mA VDD may be DVDD or AVDD depending on pin	Voh	0.9 x VDD			V
Output Low Voltage	iout = -4mA VDD may be DVDD or AVDD depending on pin	Vol			0.1 x VDD	V
Input rise/fall time	transition time between 10% and 90% of supply	T_rise/T_fall			10	ns
Input/Tristate High Leakage Current	Vin = VDD VDD may be DVDD or AVDD depending on pin (does not include pull-up or pull-down resistor if present)			0.5		uA
Input/Tristate Low Leakage Current	Vin = 0 VDD may be DVDD or AVDD depending on pin (does not include pull-up or pull-down resistor if present)			-50		uA

Table 22. GPIO Characteristics

1.High peak currents during dynamic switching of the Class-D PWM Outputs can result in Ground Rail Bounce. The amount of Ground Bounce should be kept below 0.35 x VDD for all Inputs, including internal logic which is tied to DVDD\_CORE.

4. FUNCTIONAL BLOCK DIAGRAM



Figure 15. Functional Block Diagram

5. WIDGET DIAGRAM



Figure 16. Widget Diagram

6. PORT AND PIN CONFIGURATIONS

6.1. Port Configurations

Mobile



Desktop 1



Desktop 2



Figure 17. Port Configurations

## 6.2. Pin Configuration Default Register Settings

The following table shows the Pin Widget Configuration Default settings. Desktop implementation with 2 jacks in front and 3 jacks in rear. The internal speaker is redirected from the front (green) headphone jack. An internal microphone is present.

Pin Name	Port	Location	Device	Connection	Color	Misc	Assoc.	Seq
PortAPin	Connect to Jack 00b	Mainboard Front 2h	Mic In Ah	1/8 inch Jack 1h	Pink 9h	Jack Detect Override=0	2h	0h
PortBPin	Connect to Jack 00b	Mainboard Front 2h	HP Out 2h	1/8 inch Jack 1h	Green 4h	Jack Detect Override=0	1h	Fh
PortCPin	Connect to Jack 00b	Mainboard Rear 1h	Mic In Ah	1/8 inch Jack 1h	Pink 9h	Jack Detect Override=0	2h	1h
PortDPin	Internal 10b	NA 010000b	Speaker 1h	Other Analog 7h	Unknown 0h	Jack Detect Override=1	1h	0h
PortEPin	NA							
PortFPin	Connect to Jack 00b	Mainboard Rear 1h	Line In 8h	1/8 inch Jack 1h	Blue 3h	Jack Detect Override=0	2h	Eh
MonoOutPin	NA							
DigOutPin0	NA							
DigOutPin1	NA							
DigMic0Pin	Internal 10b	Internal 010000b	Mic In Ah	ATAPI 3h	Unknown 0h	Jack Detect Override=1	3h	0h

**Table 23. Pin Configuration Default Settings**



## 7. WIDGET INFORMATION

Bits [39:32]	Bits [31:28]	BITS [27:20]	BITS[19:16]	BITS [15:0]
Reserved	CODEC Address	NID	Verb ID (4-bit)	Payload Data (16-bit)

**Table 24. Command Format for Verb with 4-bit Identifier**

Bits [39:32]	Bits [31:28]	BITS [27:20]	BITS[19:8]	BITS [7:0]
Reserved	CODEC Address	NID	Verb ID (12-bit)	Payload Data (8-bit)

**Table 25. Command Format for Verb with 12-bit Identifier**

There are two types of responses: Solicited and Unsolicited. Solicited responses are provided as a direct response to an issued command and will be provided in the frame immediately following the command. Unsolicited responses are provided by the CODEC independent of any command. Unsolicited responses are the result of CODEC events such as a jack insertion detection. The formats for Solicited Responses and Unsolicited Responses are shown in the tables below. The “Tag” field in bits [31:28] of the Unsolicited Response identify the event.

Bit [35]	Bit [34]	BITS [33:32]	BITS[31:0]
Valid (Valid = 1)	UnSol = 0	Reserved	Response

**Table 26. Solicited Response Format**

Bit [35]	Bit [34]	BITS [33:32]	BITS[31:28]	BITS [27:0]
Valid (Valid = 1)	UnSol = 1	Reserved	Tag	Response

**Table 27. Unsolicited Response Format**

## 7.1. Widget List

ID	Widget Name	Description
00h	Root	Root Node
01h	AFG	Audio Function Group
0Ah	Port A	Port A Pin Widget (Headphone, Line IN/OUT, MIC)
0Bh	Port B	Port B Pin Widget (Cap-less Headphone)
0Ch	Port C	Port C Pin Widget (Line IN/OUT, MIC)
0Dh	Port D	Port D Pin Widget (Class-D BTL MONO output)
0Eh	VSW	Vendor Defined Widget
0Fh	Port F	Port F Pin Widget (Line IN/OUT, MIC)
10h	VSW	Vendor Defined Widget
11h	DigMic0	Digital Microphone 0 Pin Widget
12h	VSW	Vendor Defined Widget
13h	DAC0	Stereo Output Converter to DAC
14h	DAC1	Stereo Output Converter to DAC
15h	ADC0	Stereo Input Converter to ADC
16h	ADC1	Stereo Input Converter to ADC
17h	ADC0Mux	ADC0 Mux with volume and mute
18h	ADC1Mux	ADC1 Mux with volume and mute
19h	VSW	Vendor Defined Widget
1Ah	VSW	Vendor Defined Widget
1Bh	Mixer	Input Mixer (Input Ports, DACs, Analog PC_Beep)
1Ch	MixerOutVol	Volume control for analog mixer
1Dh	VSW	Vendor Defined Widget
1Eh	VSW	Vendor Defined Widget
1Fh	VSW	Vendor Defined Widget
20h	VSW	Vendor Defined Widget
21h	PCBeep	Digital PC Beep
22h	VSW	Vendor Defined Widget

Table 28. Widget List

### 7.2. Reset Key

Abbreviation	Description
POR	Power On Reset.
SAFG	Single AFG Reset - One single write to the Reset Verb in the AFG Node.
DAFG	Double AFG Reset - Two consecutive Single AFG Resets with only idle frames (if any) and no Link Resets between.
S&DAFG	Single And Double AFG Reset - Either one will cause reset.
LR	Link Reset - Level sensitive reset anytime the HDA Reset is set low.
ELR	Exiting Link Reset - Edge sensitive reset any time the HDA Reset transitions from low to high.
ULR	Unexpected Link Reset - Level sensitive reset anytime the HDA Reset is set low when the ClkStopOK indicator is currently set to 0.
PS	Power State Change - Reset anytime the Actual Power State changes for the Widget in question.

### 7.3. Root (NID = 00h): VendorID

Reg	Byte 4 (Bits 31:24)	Byte 3 (Bits 23:16)	Byte 2 (Bits 15:8)	Byte 1 (Bits 7:0)
Set				
Get	F0000h			

Field Name	Bits	R/W	Default	Reset
Vendor	31:16	R	111Dh	N/A
	Vendor ID.			
DeviceFix	15:8	R	see below	N/A
	Device ID.			
DeviceProg	7:0	R	see below	N/A
	Device ID.			

<b>Device</b>	<b>92HD99</b>
Device ID	76E5h

**7.3.1. Root (NID = 00h): RevID**

Reg	Byte 4 (Bits 31:24)	Byte 3 (Bits 23:16)	Byte 2 (Bits 15:8)	Byte 1 (Bits 7:0)
Set				
Get	F0002h			

Field Name	Bits	R/W	Default	Reset
Rsvd	31:24	R	00h	N/A (Hard-coded)
	Reserved.			
Major	23:20	R	1h	N/A (Hard-coded)
	Major rev number of compliant HD Audio spec.			
Minor	19:16	R	0h	N/A (Hard-coded)
	Minor rev number of compliant HD Audio spec.			
RevisionFix	15:12	R	xh	N/A (Hard-coded)
	Vendor's rev number for this device.			
RevisionProg	11:8	R	xh	N/A (Hard-coded)
	Vendor's rev number for this device.			
SteppingFix	7:4	R	xh	N/A (Hard-coded)
	Vendor stepping number within the Vendor RevID.			
SteppingProg	3:0	R	xh	N/A (Hard-coded)
	Vendor stepping number within the Vendor RevID.			

**7.3.2. Root (NID = 00h): NodeInfo**

Reg	Byte 4 (Bits 31:24)	Byte 3 (Bits 23:16)	Byte 2 (Bits 15:8)	Byte 1 (Bits 7:0)
Set				
Get	F0004h			

Field Name	Bits	R/W	Default	Reset
Rsvd2	31:24	R	00h	N/A (Hard-coded)
	Reserved.			

Field Name	Bits	R/W	Default	Reset
StartNID	23:16	R	01h	N/A (Hard-coded)
	Starting node number (NID) of first function group			
Rsvd1	15:8	R	00h	N/A (Hard-coded)
	Reserved.			
TotalNodes	7:0	R	01h	N/A (Hard-coded)
	Total number of nodes			

#### 7.4. AFG (NID = 01h): NodeInfo

Reg	Byte 4 (Bits 31:24)	Byte 3 (Bits 23:16)	Byte 2 (Bits 15:8)	Byte 1 (Bits 7:0)
Set				
Get	F0004h			

Field Name	Bits	R/W	Default	Reset
Rsvd2	31:24	R	00h	N/A (Hard-coded)
	Reserved.			
StartNID	23:16	R	0Ah	N/A (Hard-coded)
	Starting node number for function group subordinate nodes.			
Rsvd1	15:8	R	00h	N/A (Hard-coded)
	Reserved.			
TotalNodes	7:0	R	19h	N/A (Hard-coded)
	Total number of nodes.			

##### 7.4.1. AFG (NID = 01h): FGType

Reg	Byte 4 (Bits 31:24)	Byte 3 (Bits 23:16)	Byte 2 (Bits 15:8)	Byte 1 (Bits 7:0)
Set				
Get	F0005h			

Field Name	Bits	R/W	Default	Reset
Rsvd	31:9	R	000000h	N/A (Hard-coded)
	Reserved.			
UnSol	8	R	1h	N/A (Hard-coded)
	Unsolicited response supported: 1 = yes, 0 = no.			
NodeType	7:0	R	1h	N/A (Hard-coded)
	Function group type: 00h = Reserved 01h = Audio Function Group 02h = Vendor Defined Modem Function Group 03h-7Fh = Reserved 80h-FFh = Vendor Defined Function Group			

#### 7.4.2. AFG (NID = 01h): AFGCap

Reg	Byte 4 (Bits 31:24)	Byte 3 (Bits 23:16)	Byte 2 (Bits 15:8)	Byte 1 (Bits 7:0)
Set				
Get	F0008h			

Field Name	Bits	R/W	Default	Reset
Rsvd3	31:17	R	00h	N/A (Hard-coded)
	Reserved.			
BeepGen	16	R	1h	N/A (Hard-coded)
	Beep generator present: 1 = yes, 0 = no.			
Rsvd2	15:12	R	0h	N/A (Hard-coded)
	Reserved.			
InputDelay	11:8	R	Dh	N/A (Hard-coded)
	Typical latency in frames. Number of samples between when the sample is received as an analog signal at the pin and when the digital representation is transmitted on the HD Audio link.			
Rsvd1	7:4	R	0h	N/A (Hard-coded)
	Reserved.			

Field Name	Bits	R/W	Default	Reset
OutputDelay	3:0	R	Dh	N/A (Hard-coded)
	Typical latency in frames. Number of samples between when the signal is received from the HD Audio link and when it appears as an analog signal at the pin.			

### 7.4.3. AFG (NID = 01h): PCMCap

Reg	Byte 4 (Bits 31:24)	Byte 3 (Bits 23:16)	Byte 2 (Bits 15:8)	Byte 1 (Bits 7:0)
Set				
Get	F000Ah			

Field Name	Bits	R/W	Default	Reset
Rsvd2	31:21	R	000h	N/A (Hard-coded)
	Reserved.			
B32	20	R	0h	N/A (Hard-coded)
	32 bit audio format support: 1 = yes, 0 = no.			
B24	19	R	1h	N/A (Hard-coded)
	24 bit audio format support: 1 = yes, 0 = no.			
B20	18	R	1h	N/A (Hard-coded)
	20 bit audio format support: 1 = yes, 0 = no.			
B16	17	R	1h	N/A (Hard-coded)
	16 bit audio format support: 1 = yes, 0 = no.			
B8	16	R	0h	N/A (Hard-coded)
	8 bit audio format support: 1 = yes, 0 = no.			
Rsvd1	15:12	R	0h	N/A (Hard-coded)
	Reserved.			
R12	11	R	0h	N/A (Hard-coded)
	384kHz rate support: 1 = yes, 0 = no.			
R11	10	R	1h	N/A (Hard-coded)
	192kHz rate support: 1 = yes, 0 = no.			

Field Name	Bits	R/W	Default	Reset
R10	9	R	0h	N/A (Hard-coded)
	176.4kHz rate support: 1 = yes, 0 = no.			
R9	8	R	1h	N/A (Hard-coded)
	96kHz rate support: 1 = yes, 0 = no.			
R8	7	R	1h	N/A (Hard-coded)
	88.2kHz rate support: 1 = yes, 0 = no.			
R7	6	R	1h	N/A (Hard-coded)
	48kHz rate support: 1 = yes, 0 = no.			
R6	5	R	1h	N/A (Hard-coded)
	44.1kHz rate support: 1 = yes, 0 = no.			
R5	4	R	0h	N/A (Hard-coded)
	32kHz rate support: 1 = yes, 0 = no.			
R4	3	R	0h	N/A (Hard-coded)
	22.05kHz rate support: 1 = yes, 0 = no.			
R3	2	R	0h	N/A (Hard-coded)
	16kHz rate support: 1 = yes, 0 = no.			
R2	1	R	0h	N/A (Hard-coded)
	11.025kHz rate support: 1 = yes, 0 = no.			
R1	0	R	0h	N/A (Hard-coded)
	8kHz rate support: 1 = yes, 0 = no.			

#### 7.4.4. AFG (NID = 01h): StreamCap

Reg	Byte 4 (Bits 31:24)	Byte 3 (Bits 23:16)	Byte 2 (Bits 15:8)	Byte 1 (Bits 7:0)
Set				
Get	F000Bh			



Field Name	Bits	R/W	Default	Reset
Rsvd	31:3	R	00000000h	N/A (Hard-coded)
	Reserved.			
AC3	2	R	0h	N/A (Hard-coded)
	AC-3 formatted data support: 1 = yes, 0 = no.			
Float32	1	R	0h	N/A (Hard-coded)
	Float32 formatted data support: 1 = yes, 0 = no.			
PCM	0	R	1h	N/A (Hard-coded)
	PCM-formatted data support: 1 = yes, 0 = no.			

#### 7.4.5. AFG (NID = 01h): InAmpCap

Reg	Byte 4 (Bits 31:24)	Byte 3 (Bits 23:16)	Byte 2 (Bits 15:8)	Byte 1 (Bits 7:0)
Set				
Get	F000Dh			

Field Name	Bits	R/W	Default	Reset
Mute	31	R	0h	N/A (Hard-coded)
	Mute support: 1 = yes, 0 = no.			
Rsvd3	30:23	R	00h	N/A (Hard-coded)
	Reserved.			
StepSize	22:16	R	27h	N/A (Hard-coded)
	Size of each step in the gain range: 0 to 127 = .25dB to 32dB, in .25dB steps.			
Rsvd2	15	R	0h	N/A (Hard-coded)
	Reserved.			
NumSteps	14:8	R	03h	N/A (Hard-coded)
	Number of gains steps (number of possible settings - 1).			
Rsvd1	7	R	0h	N/A (Hard-coded)
	Reserved.			

Field Name	Bits	R/W	Default	Reset
Offset	6:0	R	00h	N/A (Hard-coded)
Indicates which step is 0dB				

#### 7.4.6. AFG (NID = 01h): PwrStateCap

Reg	Byte 4 (Bits 31:24)	Byte 3 (Bits 23:16)	Byte 2 (Bits 15:8)	Byte 1 (Bits 7:0)
Set				
Get	F000Fh			

Field Name	Bits	R/W	Default	Reset
EPSS	31	R	1h	N/A (Hard-coded)
Extended power states support: 1 = yes, 0 = no.				
ClkStop	30	R	1h	N/A (Hard-coded)
D3 clock stop support: 1 = yes, 0 = no.				
S3D3ColdSup	29	R	1h	N/A (Hard-coded)
Codec state intended during system S3 state: 1 = D3Hot, 0 = D3Cold.				
Rsvd	28:5	R	000000h	N/A (Hard-coded)
Reserved.				
D3ColdSup	4	R	1h	N/A (Hard-coded)
D3Cold power state support: 1 = yes, 0 = no.				
D3Sup	3	R	1h	N/A (Hard-coded)
D3 power state support: 1 = yes, 0 = no.				
D2Sup	2	R	1h	N/A (Hard-coded)
D2 power state support: 1 = yes, 0 = no.				
D1Sup	1	R	1h	N/A (Hard-coded)
D1 power state support: 1 = yes, 0 = no.				
D0Sup	0	R	1h	N/A (Hard-coded)
D0 power state support: 1 = yes, 0 = no.				

**7.4.7. AFG (NID = 01h): GPIOCnt**

Reg	Byte 4 (Bits 31:24)	Byte 3 (Bits 23:16)	Byte 2 (Bits 15:8)	Byte 1 (Bits 7:0)
Set				
Get	F0011h			

Field Name	Bits	R/W	Default	Reset
GPIWake	31	R	1h	N/A (Hard-coded)
	Wake capability. Assuming the Wake Enable Mask controls are enabled, GPIO's configured as inputs can cause a wake (generate a Status Change event on the link) when there is a change in level on the pin.			
GPIUnsol	30	R	1h	N/A (Hard-coded)
	GPIO unsolicited response support: 1 = yes, 0 = no.			
Rsvd	29:24	R	00h	N/A (Hard-coded)
	Reserved.			
NumGPIs	23:16	R	00h	N/A (Hard-coded)
	Number of GPI pins supported by function group.			
NumGPOs	15:8	R	00h	N/A (Hard-coded)
	Number of GPO pins supported by function group.			
NumGPIOs	7:0	R	05h	N/A (Hard-coded)
	Number of GPIO pins supported by function group.			

**7.4.8. AFG (NID = 01h): OutAmpCap**

Reg	Byte 4 (Bits 31:24)	Byte 3 (Bits 23:16)	Byte 2 (Bits 15:8)	Byte 1 (Bits 7:0)
Set				
Get	F0012h			

Field Name	Bits	R/W	Default	Reset
Mute	31	R	1h	N/A (Hard-coded)
	Mute support: 1 = yes, 0 = no.			

Field Name	Bits	R/W	Default	Reset
Rsvd3	30:23	R	00h	N/A (Hard-coded)
	Reserved.			
StepSize	22:16	R	02h	N/A (Hard-coded)
	Size of each step in the gain range: 0 to 127 = .25dB to 32dB, in .25dB steps.			
Rsvd2	15	R	0h	N/A (Hard-coded)
	Reserved.			
NumSteps	14:8	R	7Fh	N/A (Hard-coded)
	Number of gains steps (number of possible settings - 1).			
Rsvd1	7	R	0h	N/A (Hard-coded)
	Reserved.			
Offset	6:0	R	7Fh	N/A (Hard-coded)
	Indicates which step is 0dB			

#### 7.4.9. AFG (NID = 01h): PwrState

Reg	Byte 4 (Bits 31:24)	Byte 3 (Bits 23:16)	Byte 2 (Bits 15:8)	Byte 1 (Bits 7:0)
Set				705h
Get	F0500h			

Field Name	Bits	R/W	Default	Reset
Rsvd3	31:11	R	000000h	N/A (Hard-coded)
	Reserved.			
SettingsReset	10	R	1h	POR - DAFG - ULR
	Indicates if any persistent settings in this Function Group have been reset. Cleared by PwrState 'Get' to this Widget.			
ClkStopOK	9	R	1h	POR - DAFG - ULR
	Bit clock can currently be removed: 1 = yes, 0 = no.			
Error	8	R	0h	POR - DAFG - ULR
	Error indicator: 1 = cannot enter requested power state, 0 = no problem with requested power state.			

Field Name	Bits	R/W	Default	Reset
Rsvd2	7	R	0h	N/A (Hard-coded)
	Reserved.			
Act	6:4	R	3h	POR - DAFG - LR
	Actual power state of this widget.			
Rsvd1	3	R	0h	N/A (Hard-coded)
	Reserved.			
Set	2:0	RW	3h	POR - DAFG - LR
	Current power state setting for this widget.			

#### 7.4.10. AFG (NID = 01h): UnsolResp

Reg	Byte 4 (Bits 31:24)	Byte 3 (Bits 23:16)	Byte 2 (Bits 15:8)	Byte 1 (Bits 7:0)
Set				708h
Get	F0800h			

Field Name	Bits	R/W	Default	Reset
Rsvd2	31:8	R	000000h	N/A (Hard-coded)
	Reserved.			
En	7	RW	0h	POR - DAFG - ULR
	Unsolicited response enable: 1 = enabled, 0 = disabled.			
Rsvd1	6	R	0h	N/A (Hard-coded)
	Reserved.			
Tag	5:0	RW	00h	POR - DAFG - ULR
	Software programmable field returned in top six bits (31:26) of every Unsolicited Response generated by this node.			

#### 7.4.11. AFG (NID = 01h): GPIO

Reg	Byte 4 (Bits 31:24)	Byte 3 (Bits 23:16)	Byte 2 (Bits 15:8)	Byte 1 (Bits 7:0)
Set				715h
Get	F1500h			

Field Name	Bits	R/W	Default	Reset
Rsvd	31:5	R	00000000h	N/A (Hard-coded)
	Reserved.			
Data4	4	RW	0h	POR - DAFG - ULR
	Data for GPIO4. If this GPIO bit is configured as Sticky (edge-sensitive) input, it can be cleared by writing "0". For details of read back value, refer to HD Audio spec. section 7.3.3.22			
Data3	3	RW	0h	POR - DAFG - ULR
	Data for GPIO3. If this GPIO bit is configured as Sticky (edge-sensitive) input, it can be cleared by writing "0". For details of read back value, refer to HD Audio spec. section 7.3.3.22			
Data2	2	RW	0h	POR - DAFG - ULR
	Data for GPIO2. If this GPIO bit is configured as Sticky (edge-sensitive) input, it can be cleared by writing "0". For details of read back value, refer to HD Audio spec. section 7.3.3.22			
Data1	1	RW	0h	POR - DAFG - ULR
	Data for GPIO1. If this GPIO bit is configured as Sticky (edge-sensitive) input, it can be cleared by writing "0". For details of read back value, refer to HD Audio spec. section 7.3.3.22			
Data0	0	RW	0h	POR - DAFG - ULR
	Data for GPIO0. If this GPIO bit is configured as Sticky (edge-sensitive) input, it can be cleared by writing "0". For details of read back value, refer to HD Audio spec. section 7.3.3.22			

#### 7.4.12. AFG (NID = 01h): GPIOEn

Reg	Byte 4 (Bits 31:24)	Byte 3 (Bits 23:16)	Byte 2 (Bits 15:8)	Byte 1 (Bits 7:0)
Set				716h
Get	F1600h			

Field Name	Bits	R/W	Default	Reset
Rsvd	31:5	R	00000000h	N/A (Hard-coded)
	Reserved.			

Field Name	Bits	R/W	Default	Reset
Mask4	4	RW	0h	POR - DAFG - ULR
	Enable for GPIO4: 0 = pin is disabled (Hi-Z state); 1 = pin is enabled; behavior determined by GPIO Direction control			
Mask3	3	RW	0h	POR - DAFG - ULR
	Enable for GPIO3: 0 = pin is disabled (Hi-Z state); 1 = pin is enabled; behavior determined by GPIO Direction control			
Mask2	2	RW	0h	POR - DAFG - ULR
	Enable for GPIO2: 0 = pin is disabled (Hi-Z state); 1 = pin is enabled; behavior determined by GPIO Direction control			
Mask1	1	RW	0h	POR - DAFG - ULR
	Enable for GPIO1: 0 = pin is disabled (Hi-Z state); 1 = pin is enabled; behavior determined by GPIO Direction control			
Mask0	0	RW	0h	POR - DAFG - ULR
	Enable for GPIO0: 0 = pin is disabled (Hi-Z state); 1 = pin is enabled; behavior determined by GPIO Direction control			

#### 7.4.13. AFG (NID = 01h): GPIODir

Reg	Byte 4 (Bits 31:24)	Byte 3 (Bits 23:16)	Byte 2 (Bits 15:8)	Byte 1 (Bits 7:0)
Set				717h
Get	F1700h			

Field Name	Bits	R/W	Default	Reset
Rsvd	31:5	R	00000000h	N/A (Hard-coded)
	Reserved.			
Control4	4	RW	0h	POR - DAFG - ULR
	Direction control for GPIO4: 0 = GPIO is configured as input; 1 = GPIO is configured as output			
Control3	3	RW	0h	POR - DAFG - ULR
	Direction control for GPIO3: 0 = GPIO is configured as input; 1 = GPIO is configured as output			

Field Name	Bits	R/W	Default	Reset
Control2	2	RW	0h	POR - DAFG - ULR
	Direction control for GPIO2: 0 = GPIO is configured as input; 1 = GPIO is configured as output			
Control1	1	RW	0h	POR - DAFG - ULR
	Direction control for GPIO1: 0 = GPIO is configured as input; 1 = GPIO is configured as output			
Control0	0	RW	0h	POR - DAFG - ULR
	Direction control for GPIO0: 0 = GPIO is configured as input; 1 = GPIO is configured as output			

#### 7.4.14. AFG (NID = 01h): GPIOWakeEn

Reg	Byte 4 (Bits 31:24)	Byte 3 (Bits 23:16)	Byte 2 (Bits 15:8)	Byte 1 (Bits 7:0)
Set				718h
Get	F1800h			

Field Name	Bits	R/W	Default	Reset
Rsvd	31:5	R	00000000h	N/A (Hard-coded)
	Reserved.			
W4	4	RW	0h	POR - DAFG - ULR
	Wake enable for GPIO4: 0 = wake-up event is disabled; 1 = When HD Audio link is powered down (RST# is asserted), a wake-up event will trigger a Status Change Request event on the link.			
W3	3	RW	0h	POR - DAFG - ULR
	Wake enable for GPIO3: 0 = wake-up event is disabled; 1 = When HD Audio link is powered down (RST# is asserted), a wake-up event will trigger a Status Change Request event on the link.			
W2	2	RW	0h	POR - DAFG - ULR
	Wake enable for GPIO2: 0 = wake-up event is disabled; 1 = When HD Audio link is powered down (RST# is asserted), a wake-up event will trigger a Status Change Request event on the link.			



Field Name	Bits	R/W	Default	Reset
W1	1	RW	0h	POR - DAFG - ULR
	Wake enable for GPIO1: 0 = wake-up event is disabled; 1 = When HD Audio link is powered down (RST# is asserted), a wake-up event will trigger a Status Change Request event on the link.			
W0	0	RW	0h	POR - DAFG - ULR
	Wake enable for GPIO0: 0 = wake-up event is disabled; 1 = When HD Audio link is powered down (RST# is asserted), a wake-up event will trigger a Status Change Request event on the link.			

#### 7.4.15. AFG (NID = 01h): GPIOUnsol

Reg	Byte 4 (Bits 31:24)	Byte 3 (Bits 23:16)	Byte 2 (Bits 15:8)	Byte 1 (Bits 7:0)
Set				719h
Get	F1900h			

Field Name	Bits	R/W	Default	Reset
Rsvd	31:5	R	00000000h	N/A (Hard-coded)
	Reserved.			
EnMask4	4	RW	0h	POR - DAFG - ULR
	Unsolicited enable mask for GPIO4. If set, and the Unsolicited Response control for this widget has been enabled, an unsolicited response will be sent when GPIO2 is configured as input and changes state.			
EnMask3	3	RW	0h	POR - DAFG - ULR
	Unsolicited enable mask for GPIO3. If set, and the Unsolicited Response control for this widget has been enabled, an unsolicited response will be sent when GPIO2 is configured as input and changes state.			
EnMask2	2	RW	0h	POR - DAFG - ULR
	Unsolicited enable mask for GPIO2. If set, and the Unsolicited Response control for this widget has been enabled, an unsolicited response will be sent when GPIO2 is configured as input and changes state.			
EnMask1	1	RW	0h	POR - DAFG - ULR
	Unsolicited enable mask for GPIO1. If set, and the Unsolicited Response control for this widget has been enabled, an unsolicited response will be sent when GPIO1 is configured as input and changes state.			

Field Name	Bits	R/W	Default	Reset
EnMask0	0	RW	0h	POR - DAFG - ULR
Unsolicited enable mask for GPIO0. If set, and the Unsolicited Response control for this widget has been enabled, an unsolicited response will be sent when GPIO0 is configured as input and changes state.				

#### 7.4.16. AFG (NID = 01h): GPIOSticky

Reg	Byte 4 (Bits 31:24)	Byte 3 (Bits 23:16)	Byte 2 (Bits 15:8)	Byte 1 (Bits 7:0)
Set				71Ah
Get	F1A00h			

Field Name	Bits	R/W	Default	Reset
Rsvd	31:5	R	00000000h	N/A (Hard-coded)
Reserved.				
Mask4	4	RW	0h	POR - DAFG - ULR
GPIO4 input type (when configured as input): 0 = Non-Sticky (level-sensitive); 1 = Sticky (edge-sensitive).				
Mask3	3	RW	0h	POR - DAFG - ULR
GPIO3 input type (when configured as input): 0 = Non-Sticky (level-sensitive); 1 = Sticky (edge-sensitive).				
Mask2	2	RW	0h	POR - DAFG - ULR
GPIO2 input type (when configured as input): 0 = Non-Sticky (level-sensitive); 1 = Sticky (edge-sensitive).				
Mask1	1	RW	0h	POR - DAFG - ULR
GPIO1 input type (when configured as input): 0 = Non-Sticky (level-sensitive); 1 = Sticky (edge-sensitive).				
Mask0	0	RW	0h	POR - DAFG - ULR
GPIO0 input type (when configured as input): 0 = Non-Sticky (level-sensitive); 1 = Sticky (edge-sensitive).				

#### 7.4.17. AFG (NID = 01h): SubID

Reg	Byte 4 (Bits 31:24)	Byte 3 (Bits 23:16)	Byte 2 (Bits 15:8)	Byte 1 (Bits 7:0)
Set	723h	722h	721h	720h

**7.4.17. AFG (NID = 01h): SubID**

Reg	Byte 4 (Bits 31:24)	Byte 3 (Bits 23:16)	Byte 2 (Bits 15:8)	Byte 1 (Bits 7:0)
Get	F2300h / F2200h / F2100h / F2000h			

Field Name	Bits	R/W	Default	Reset
Subsys3	31:24	RW	00h	POR
	Subsystem ID (byte 3)			
Subsys2	23:16	RW	00h	POR
	Subsystem ID (byte 2)			
Subsys1	15:8	RW	01h	POR
	Subsystem ID (byte 1)			
Assembly	7:0	RW	00h	POR
	Assembly ID (Not applicable to codec vendors).			

**7.4.18. AFG (NID = 01h): GPIOIrty**

Reg	Byte 4 (Bits 31:24)	Byte 3 (Bits 23:16)	Byte 2 (Bits 15:8)	Byte 1 (Bits 7:0)
Set				770h
Get	F7000h			

Field Name	Bits	R/W	Default	Reset
Rsvd	31:5	R	00000000h	N/A (Hard-coded)
	Reserved.			
GP4	4	RW	1h	POR - DAFG - ULR
	GPIO4 Polarity: If configured as output or non-sticky input: 0 = inverting 1 = non-inverting  If configured as sticky input: 0 = falling edges will be detected 1 = rising edges will be detected			

Field Name	Bits	R/W	Default	Reset
GP3	3	RW	1h	POR - DAFG - ULR
	GPIO3 Polarity: If configured as output or non-sticky input: 0 = inverting 1 = non-inverting  If configured as sticky input: 0 = falling edges will be detected 1 = rising edges will be detected			
GP2	2	RW	1h	POR - DAFG - ULR
	GPIO2 Polarity: If configured as output or non-sticky input: 0 = inverting 1 = non-inverting  If configured as sticky input: 0 = falling edges will be detected 1 = rising edges will be detected			
GP1	1	RW	1h	POR - DAFG - ULR
	GPIO1 Polarity: If configured as output or non-sticky input: 0 = inverting 1 = non-inverting  If configured as sticky input: 0 = falling edges will be detected 1 = rising edges will be detected			
GP0	0	RW	1h	POR - DAFG - ULR
	GPIO0 Polarity: If configured as output or non-sticky input: 0 = inverting 1 = non-inverting  If configured as sticky input: 0 = falling edges will be detected 1 = rising edges will be detected			

#### 7.4.19. AFG (NID = 01h): GPIODrive

Reg	Byte 4 (Bits 31:24)	Byte 3 (Bits 23:16)	Byte 2 (Bits 15:8)	Byte 1 (Bits 7:0)
Set				771h
Get	F7100h			

# 92HD99

## SINGLE CHIP PC AUDIO SYSTEM, CODEC+SPEAKER AMPLIFIER+CAPLESS HP+LDO

Field Name	Bits	R/W	Default	Reset
Rsvd	31:5	R	00000000h	N/A (Hard-coded)
	Reserved.			
OD4	4	RW	0h	POR - DAFG - ULR
	GPIO4 Drive Mode: 0 = push-pull (drive 0 and 1); 1 = open drain (drive 0, float for 1).			
OD3	3	RW	0h	POR - DAFG - ULR
	GPIO3 Drive Mode: 0 = push-pull (drive 0 and 1); 1 = open drain (drive 0, float for 1).			
OD2	2	RW	0h	POR - DAFG - ULR
	GPIO2 Drive Mode: 0 = push-pull (drive 0 and 1); 1 = open drain (drive 0, float for 1).			
OD1	1	RW	0h	POR - DAFG - ULR
	GPIO1 Drive Mode: 0 = push-pull (drive 0 and 1); 1 = open drain (drive 0, float for 1).			
OD0	0	RW	0h	POR - DAFG - ULR
	GPIO0 Drive Mode: 0 = push-pull (drive 0 and 1); 1 = open-drain (drive 0, float for 1).			

### 7.4.20. AFG (NID = 01h): DMic

Reg	Byte 4 (Bits 31:24)	Byte 3 (Bits 23:16)	Byte 2 (Bits 15:8)	Byte 1 (Bits 7:0)
Set				778h
Get	F7800h			

Field Name	Bits	R/W	Default	Reset
Rsvd	31:6	R	0000000h	N/A (Hard-coded)
	Reserved.			
Mono1	5	RW	0h	POR
	DMic1 mono select: 0 = stereo operation, 1 = mono operation (left channel duplicated to the right channel).			

Field Name	Bits	R/W	Default	Reset
Mono0	4	RW	0h	POR
	DMic0 mono select: 0 = stereo operation, 1 = mono operation (left channel duplicated to the right channel).			
PhAdj	3:2	RW	0h	POR
	Selects what phase of the DMic clock the data should be latched: 0h = left data rising edge/right data falling edge 1h = left data center of high/right data center of low 2h = left data falling edge/right data rising edge 3h = left data center of low/right data center of high			
Rate	1:0	RW	2h	POR
	Selects the DMic clock rate: 0h = 4.704MHz 1h = 3.528MHz 2h = 2.352MHz 3h = 1.176MHz.			

#### 7.4.21. AFG (NID = 01h): DACMode

Reg	Byte 4 (Bits 31:24)	Byte 3 (Bits 23:16)	Byte 2 (Bits 15:8)	Byte 1 (Bits 7:0)
Set				780h
Get	F8000h			

Field Name	Bits	R/W	Default	Reset
Rsvd	31:8	R	000000h	N/A (Hard-coded)
	Reserved.			
SwapEn	8	RW	0h	POR
	Internal DAC left channel and right channel swap. 0h = not swap, 1h = swap.			
SDMSettleDisable	7	RW	0h	POR
	SDM wait-to-settle disable: 1 = at mute, the SDM switches to the mute pattern immediately 0 = at mute, the SDM switches to the mute pattern after settling (can take up to ~45ms)			

Field Name	Bits	R/W	Default	Reset
SDMCoeffSel	6	RW	0h	POR
	DAC SDM coefficient select (stages 1, 2, 3): 1 = 1/16, 1/2, 1/4 0 = 1/16, 1/4, 1/2			
SDMLFHalf	5	RW	0h	POR
	DAC SDM local feedback coefficient select: 1 = 1/4096, 0 = 1/2048.			
SDMLFDisable	4	RW	0h	POR
	DAC SDM local feedback disable: 1 = local feedback disabled, 0 = local feedback enabled.			
InvertValid	3	RW	0h	POR
	DAC Valid Invert: 1 = 7.056MHz valid strobe is inverted, 0 = 7.056MHz valid strobe is not inverted.			
InvertData	2	RW	0h	POR
	DAC Data Invert: 1 = 1-bit outputs are inverted, 0 = 1-bit outputs are not inverted.			
Atten6dBDisable	1	RW	1h	POR
	Disable built-in -6dB digital attenuation: 1 = -6dB disabled, 0 = -6dB enabled.			
Fade	0	RW	1h	POR
	DAC Gain Fade Enable: 1 = gain will be slowly faded from old value to new value (~10ms) 0 = gain will jump immediately to new value.			

#### 7.4.22. AFG (NID = 01h): ADCMode

Reg	Byte 4 (Bits 31:24)	Byte 3 (Bits 23:16)	Byte 2 (Bits 15:8)	Byte 1 (Bits 7:0)
Set				784h
Get	F8400h			

Field Name	Bits	R/W	Default	Reset
Rsvd2	31:4	R	0000000h	N/A (Hard-coded)
	Reserved.			

Field Name	Bits	R/W	Default	Reset
InvertValid	3	RW	0h	POR
	ADC Valid Invert: 1 = 14.112MHz valid strobe is inverted, 0 = 14.112MHz valid strobe is not inverted.			
InvertData	2	RW	0h	POR
	ADC Data Invert: 1 = 1-bit inputs are inverted, 0 = 1-bit inputs are not inverted.			
ADCClkDelay	1	RW	0h	POR
	Delay ADC clock.			
DACClkDelay	0	RW	0h	POR
	Delay DAC clock.			

#### 7.4.23. AFG (NID = 01h): PortUse

Reg	Byte 4 (Bits 31:24)	Byte 3 (Bits 23:16)	Byte 2 (Bits 15:8)	Byte 1 (Bits 7:0)
Set				7C0h
Get	FC000h			

Field Name	Bits	R/W	Default	Reset
Rsvd	31:7	R	0000000h	N/A (Hard-coded)
	Reserved.			
Mono	6	RW	1h	POR
	1=power down port if not input or output enabled, 0=do not force power down based on input or output enable			
PortF	5	RW	1h	POR
	1=power down port if not input or output enabled, 0=do not force power down based on input or output enable			
PortE	4	RW	1h	POR
	1=power down port if not input or output enabled, 0=do not force power down based on input or output enable			
PortD	3	RW	1h	POR
	1=power down port if not input or output enabled, 0=do not force power down based on input or output enable.			



Field Name	Bits	R/W	Default	Reset
PortC	2	RW	1h	POR
	1=power down port if not input or output enabled, 0=do not force power down based on input or output enable			
PortB	1	RW	1h	POR
	1=power down port if not input or output enabled, 0=do not force power down based on input or output enable			
PortA	0	RW	1h	POR
	1=power down port if not input or output enabled, 0=do not force power down based on input or output enable.			

**7.4.24. AFG (NID = 01h): ComJack**

Reg	Byte 4 (Bits 31:24)	Byte 3 (Bits 23:16)	Byte 2 (Bits 15:8)	Byte 1 (Bits 7:0)
Set			7C7h	7C6h
Get	FC700h/FC600h			

Field Name	Bits	R/W	Default	Reset
Rsvd3	31:14	R	00000000h	N/A (Hard-coded)
	Reserved.			
DebounceTime	13:12	RW	1h	POR
	Combo Jack debounce time set. 2'h0 = 0.1ms; 2'h1 = 125ms; 2'h2 = 500ms; 2'h3 = 1s."			
Rsvd2	11	R	0h	N/A (Hard-coded)
	Reserved.			
RbCon	10:8	RW	4h	POR
	Combo jack detection reference voltage  000 = 0.18*AVDD 001 = 0.16*AVDD 010 = 0.14*AVDD 011 = 0.12*AVDD 100 = 0.10*AVDD 101 = 0.08*AVDD 110 = 0.06*AVDD 111 = 0.04*AVDD			

# 92HD99

## SINGLE CHIP PC AUDIO SYSTEM, CODEC+SPEAKER AMPLIFIER+CAPLESS HP+LDO

Field Name	Bits	R/W	Default	Reset
MasterPort	7:5	RW	0h	POR
	Port tied to the jack presence detection switch  000 = Port A 001 = Port B 010 = Port C 011 = Port D 100 = Port E 101 = Port F			
Rsvd1	4	R	0h	N/A (Hard-coded)
	Reserved.			
SlavePort	3:1	RW	0h	POR
	Port used as microphone input  When combo jack detection is enabled, Port presence detection as shown in the pin complex is not sensed directly by the sense input but is inferred by the load placed on the Vref_Output associated with the port  000 = Port A 001 = Port B 010 = Port C 011 = Port D; 100 = Port E 101 = Port F			
Det-en	0	R	0h	POR
	0h = disable combo jact detection 1h = enable combo jact detection			

### 7.4.25. AFG (NID = 01h): VSPwrState

Reg	Byte 4 (Bits 31:24)	Byte 3 (Bits 23:16)	Byte 2 (Bits 15:8)	Byte 1 (Bits 7:0)
Set				7D8h
Get	FD800h			

Field Name	Bits	R/W	Default	Reset
Rsvd	31:2	R	00000000h	N/A (Hard-coded)
	Reserved.			

Field Name	Bits	R/W	Default	Reset
D5	1	RW	0h	POR - ELR
	Vendor specific D5 power state, only entered once the part is already in D3cold (this bit must be set before the command to enter D3cold). If set, this bit overrides the D4 bit (bit 0). Includes the power savings of D4, but additionally powers down GPIO pins, the VAG amp, and the HP amps. Exits this power state via POR or rising edge of Link Reset.			
D4	0	RW	0h	POR - ELR
	Vendor specific D4 power state, only entered once the part is already in D3cold (this bit must be set before the command to enter D3cold). If the D5 bit (bit 1) is set, this bit is overridden. Includes the power savings of D3cold, but additionally powers down the HDA interface (no responses). Exit this power state via POR or rising edge of Link Reset.			

#### 7.4.26. AFG (NID = 01h): AnaPort

Reg	Byte 4 (Bits 31:24)	Byte 3 (Bits 23:16)	Byte 2 (Bits 15:8)	Byte 1 (Bits 7:0)
Set			7EDh	7ECh
Get	FEC00h			

Field Name	Bits	R/W	Default	Reset
Rsvd2	31:7	R	0000000h	N/A (Hard-coded)
	Reserved.			
MonoPw	6	RW	0h	POR
	Power down Mono Output.			
FPw	5	RW	0h	POR
	Power down Port F.			
EPw	4	RW	0h	POR
	Power down Port E.			
DPw	3	RW	0h	POR
	Power down Port D.			
CPw	2	RW	0h	POR
	Power down Port C.			

Field Name	Bits	R/W	Default	Reset
BPwd	1	RW	0h	POR
	Power down Port B.			
APwd	0	RW	0h	POR
	Power down Port A.			

#### 7.4.27. AFG (NID = 01h): AnaBTL

Reg	Byte 4 (Bits 31:24)	Byte 3 (Bits 23:16)	Byte 2 (Bits 15:8)	Byte 1 (Bits 7:0)
Set		7F6h	7F5h	7F4h
Get	FF400h			

Field Name	Bits	R/W	Default	Reset
Rsvd6	31:22	R	0h	N/A (Hard-coded)
	Reserved.			
SCStableTimeSel	21:22	RW	0h	POR
	The programmed time window for short circuit detect. <b>This is available on WB silicon revisions and beyond. Prior silicon revisions, these bits are reserved.</b>			
TSOverrideHiz	19	RW	0h	POR
	Override Hiz for the BTL amplifier power stage circuit: set to 1 to Hiz, set back to 0 to normal mode			
TSTestMode	18	RW	0h	POR
	Temp sense test mode select, 0=normal operation, 1=sensor will trip at ambient temperature.			
TSForcePwd	17	RW	1h	POR
	Temp sense force powerdown select 0=BTL will not be muted and powered down even if it is still overheating when the volume is 0h 1=BTL will be muted and powered down even if it is still overheating when the volume is 0h			
TSInstantCutMode	16	RW	0h	POR
	Temp sense instant cut mode 0=Two trip points used to smoothly adjust the volume 1=One single trip point used to set volume to wither 0 or max value (TI mode)			

**92HD99**

**SINGLE CHIP PC AUDIO SYSTEM, CODEC+SPEAKER AMPLIFIER+CAPLESS HP+LDO**

Field Name	Bits	R/W	Default	Reset
TSWait	15:12	RW	3h	POR
	Temperature sensing wait time between volume increments 0h = 2ms (polling at 2ms) 1h = 4ms (polling at 4ms) 2h = 8ms (polling at 8ms) 3h = 16ms (polling at 16ms) 4h = 32ms (polling at 16ms) 5h = 64ms (polling at 16ms) 6h = 128ms (polling at 16ms) 7h = 256ms (polling at 16ms) 8h = 512ms (polling at 16ms) 9h = 1.024s (polling at 16ms) Ah = 2.048s (polling at 16ms) Bh = 4.096s (polling at 16ms) Ch = 8.192s (polling at 16ms) Dh = 16.384s (polling at 16ms) Eh = 32.768s (polling at 16ms) Fh = 65.536s (polling at 16ms).			
TSTripHish	11:9	RW	3h	POR
	Temp sense high trip point setting: 0h = 125 Degrees C 1h = 140 Degrees C 2h = 155 Degrees C 3h = 170 Degrees C 4h = 185 C 5h = 200 C 6h = 215 C 7h = Reserved			
TSOverrideRest	8	RW	0h	POR
	Override reset for the BTL amplifier Temp sense circuit: set to 1 to recalculate, set back to 0 to latch the value			
TSTripLow	7:5	RW	2h	POR
	Temp sense low trip point setting: 0h = 110 Degrees C 1h = 125 Degrees C 2h = 140 Degrees C 3h = 155 Degrees C 4h = 170 C 5h = 185 C 6h = 200 C 7h = 215 C			
Rsvd1	4:0	R	0h	NA
	Reserved			

**7.4.28. AFG (NID = 01h): AnaBTLStatus**

Reg	Byte 4 (Bits 31:24)	Byte 3 (Bits 23:16)	Byte 2 (Bits 15:8)	Byte 1 (Bits 7:0)
Set				
Get	FF700h			

Field Name	Bits	R/W	Default	Reset
Rsvd	31:20	R	00h	N/A (Hard-coded)
	Reserved.			
TSTripHigh	19	R	0h	POR
	Temp sense high trip point status			
TSTripLow	18	R	0h	POR
	Temp sense low trip point status			
TSMute	17	R	0h	POR
	Temp sense forced mute status for BTL amplifier			
TSPwd	16	R	0h	POR
	Temp sense forced powerdown status for BTL amplifier			
TSLeftVol	15:8	R	0h	POR
	Temp sense volume status for the BTL amplifier: 00000000b..11111111b = Range specified for SPKVol field.			
TSRightVol	7:0	R	0h	POR
	Temp sense volume status for the BTL amplifier: 00000000b..11111111b = Range specified for SPKVol field.			

**7.4.29. AFG (NID = 01h): AnaCapless**

Reg	Byte 4 (Bits 31:24)	Byte 3 (Bits 23:16)	Byte 2 (Bits 15:8)	Byte 1 (Bits 7:0)
Set		7FAh	7F9h	7F8h
Get	FF800h			

Field Name	Bits	R/W	Default	Reset
Rsvd2	31:26	R	00h	N/A (Hard-coded)
	Reserved.			
VRegSCDet	25	R	0h	POR
	Capless regulator short circuit detect indicator.			
ChargePumpSCDet	24	R	0h	POR
	Capless charge pump short circuit detect indicator.			
VRegSel	23:20	RW	5h	POR
	Capless regulator output voltage multiply ratio Bits [3..2] Reserved  Bits [1..0]: 00b = 2*Vbg 01b = 2.1*Vbg 10b = 2.2*Vbg 11b = 2.3*Vbg			
VRegSCRstB	19	RW	0h	POR
	Capless regulator short circuit detect reset: 0 = short circuit detect disabled, 1 = short circuit detect enabled.			
VRegGndShort	18	RW	0h	POR
	Ground the capless regulator output.			
VRegPwd	17	RW	0h	POR
	Capless regulator powerdown.			
ChargePumpSCRstB	16	RW	0h	POR
	Capless charge pump short circuit detect reset: 0 = short circuit detect disabled, 1 = short circuit detect enabled.			
ChargePumpHiZ	15	RW	0h	POR
	Hi-Z the capless charge pump outputs.			
ChargePumpPwd	14	RW	0h	POR
	Capless charge pump powerdown.			
ChargePumpSplyDetOverride	13	RW	0h	POR
	Capless charge pump supply detect override.			

# 92HD99

## SINGLE CHIP PC AUDIO SYSTEM, CODEC+SPEAKER AMPLIFIER+CAPLESS HP+LDO

Field Name	Bits	R/W	Default	Reset
ChargePumpFreqBypass	12	RW	1h	POR
	Capless charge pump frequency reg bypass.			
ChargePumpClkRate	11:8	RW	8h	POR
	Capless charge pump clock rate: 0000b = 800.0kHz (24MHz/30) 0001b = 750.0kHz (24MHz/32) 0010b = 706.9kHz (24MHz/34) 0011b = 666.7kHz (24MHz/36) 0100b = 631.6kHz (24MHz/38) 0101b = 600.0kHz (24MHz/40) 0110b = 571.4kHz (24MHz/42) 0111b = 545.5kHz (24MHz/44) 1000b = 800.0kHz (24MHz/30) 1001b = 857.1kHz (24MHz/28) 1010b = 923.1kHz (24MHz/26) 1011b = 1.000MHz (24MHz/24) 1100b = 1.091MHz (24MHz/22) 1101b = 1.200MHz (24MHz/20) 1110b = 1.333MHz (24MHz/18) 1111b = 1.500MHz (24MHz/16)			
ChargePumpClkDiv	7:5	RW	4h	POR
	Capless charge pump analog clock divider: 001b = No divide 010b = Divide by 2, 50% duty cycle 100b = Divide by 4, 50% duty cycle 110b = Divide by 2, 75% duty cycle 011b = Divide by 4, 75% duty cycle 111b = Divide by 4, 87.5% duty cycle Other values undefined			
ChargePumpClkSel	4	RW	0h	POR
	Capless charge pump clock select: 0 = ring oscillator, 1 = charge pump clock defined by AFGCaplessChargePumpClkRate[3:0] field below.			
PadGnd	3	RW	0h	POR
	Ground the output pad of the capless amplifiers.			
InputGnd	2	RW	0h	POR
	Ground the input to the capless output amplifiers.			
Rsvd1	1	R	0h	NA
	Reserved			



Field Name	Bits	R/W	Default	Reset
AntiPopBypass	0	RW	0h	POR
0 = Enable anti-pop on the capless headphone; 1 = bypass anti-pop on the capless headphone.				

#### 7.4.30. AFG (NID = 01h): Reset

Reg	Byte 4 (Bits 31:24)	Byte 3 (Bits 23:16)	Byte 2 (Bits 15:8)	Byte 1 (Bits 7:0)
Set				7FFh
Get	FFF00h			

Field Name	Bits	R/W	Default	Reset
Rsvd1	31:8	R	000000h	N/A (Hard-coded)
Reserved.				
Execute	7:0	W	00h	N/A (Hard-coded)
Function Reset. Function Group reset is executed when the Set verb 7FF is written with 8-bit payload of 00h. The codec should issue a response to acknowledge receipt of the verb, and then reset the affected Function Group and all associated widgets to their power-on reset values. Some controls such as Configuration Default controls should not be reset. Overlaps Response.				

## 7.4.31. AFG (NID = 01h): AnaBeep

Reg	Byte 4 (Bits 31:24)	Byte 3 (Bits 23:16)	Byte 2 (Bits 15:8)	Byte 1 (Bits 7:0)
Set			7EFh	7EEh
Get	FEE00h / FEE00h			

Field Name	Bits	R/W	Default	Reset
Rsvd2	31:14	R	00000h	N/A (Hard-coded)
	Reserved.			
Detect	13	R	0h	POR - DAFG - ULR
	0: no beep present; 1: beep present.			
GainAdj	12:10	RW	3h	POR
	Analog PC Beep Gain in digital side 7h = -6dB, 6h = -12dB, 5h = -18dB, 4h = -24dB, 3h = -30dB, 2h = -36dB, 1h = -42dB, 0h = -48dB.			
ConvertEn	9	RW	1h	POR
	Analog pc beep quantization enable (enabled only when both ""d2a_ana_pc_beep_det_en"" and ""d2a_ana_pc_beep_convert_en"" are 1).			
DetectEn	8	RW	1h	POR
	Analog pc beep detection enable 0h = disable 1h = enable.			
Rsvd1	7:6	R	0h	N/A (Hard-coded)
Gain	5:4	RW	3h	POR
	Analog PC Beep Gain: 0h = -24dB, 1h = -18dB, 2h = -12dB, 3h = -6dB.			
CntSel	3:2	RW	0h	POR
	Select counter delay.0h=64ms,1h = 128ms, 2h = 256ms, 3h = 512ms.			
Mode	1:0	RW	2h	POR
	Analog PC Beep Mode: 00b = Always disabled 01b = Always enabled 1Xb = Enabled during HDA Link Reset only			

## 7.4.32. AFG (NID = 01h): EAPD

Reg	Byte 4 (Bits 31:24)	Byte 3 (Bits 23:16)	Byte 2 (Bits 15:8)	Byte 1 (Bits 7:0)
Set				788h
Get	F8800h			

Field Name	Bits	R/W	Default	Reset
Rsvd4	31:15	R	00000h	N/A (Hard-coded)
	Reserved.			
HPBSDInv	14	RW	0h	POR
	Port B HP Amp Shutdown Invert: 0 = Amp will power down (or mute) when EAPD pin is low 1 = Amp will power down (or mute) when EAPD pin is high			
HPBSDMode	13	RW	1h	POR
	Port B HP Amp Shutdown Mode: 0 = Amp will mute when disabled 1 = Amp will enter a low power state when disabled			
HPBSD	12	RW	0h	POR
	Port B HP Amp Shutdown Control Select: 0 = Amp controlled by EAPD pin only 1 = Amp controlled by power state only			
Rsvd3	11	R	0h	N/A (Hard-coded)
	Reserved.			
HPASDInv	10	RW	0h	POR
	Port A HP Amp Shutdown Invert: 0 = Amp will power down (or mute) when EAPD pin is low 1 = Amp will power down (or mute) when EAPD pin is high			
HPASDMode	9	RW	1h	POR
	Port A HP Amp Shutdown Mode: 0 = Amp will mute when disabled 1 = Amp will enter a low power state when disabled			
HPASD	8	RW	0h	POR
	Port A HP Amp Shutdown Control Select: 0 = Amp controlled by EAPD pin only 1 = Amp controlled by power state only			

**92HD99****SINGLE CHIP PC AUDIO SYSTEM, CODEC+SPEAKER AMPLIFIER+CAPLESS HP+LDO**

Field Name	Bits	R/W	Default	Reset
Rsvd2	7	R	0h	N/A (Hard-coded)
	Reserved.			
BTLSDInv	6	RW	0h	POR
	BTL Amp Shutdown Invert: 0 = Amp will power down (or mute) when EAPD pin is low 1 = Amp will power down (or mute) when EAPD pin is high			
BTLSDMode	5	RW	1h	POR
	BTL Amp Shutdown Mode: 0 = Amp will mute when disabled 1 = Amp will enter a low power state when disabled			
BTLSD	4	RW	0h	POR
	BTL Amp Shutdown Control Select: 0 = Amp controlled by EAPD pin only 1 = Amp controlled by power state only			
Rsvd1	3:2	R	0h	N/A (Hard-coded)
	Reserved.			
PinMode	1:0	RW	0h	POR
	EAPD Pin Mode: 00b = Open Drain I/O (Value at pin is wired-AND of EAPD bit & external signal) 01b = CMOS Output (Value of EAPD bit is forced at pin) 1xb = CMOS Input (External signal controls internal amps, EAPD bit ignored)			

**7.4.33. AFG (NID = 01h): ComboJackTime (Available only on WB revision and beyond)**

Reg	Byte 4 (Bits 31:24)	Byte 3 (Bits 23:16)	Byte 2 (Bits 15:8)	Byte 1 (Bits 7:0)
Set			7CAh	7C9h
Get	FCA00h/FC900h			

Field Name	Bits	R/W	Default	Reset
Rsvd3	31:16	R	0000000h	N/A (Hard-coded)
	Reserved.			
bouncertimer_bypass	15	RW	0h	POR
	0 = all the combjack debounce time in normal; 1 = all the comjack debounce time in simulation mode(debounce time is short).			
t_delay_slave_port_usr	14:12	RW	3h	POR
	000 = 2frame 001 =4frame 010 =8frame 011 =16frame 100 = 32frame 101 =64frame 110 = 128frame 111 = 256frame			
t_stable	11:8	RW	7h	POR
	0000 = 0.1ms 0001 =0.5ms 0010 =1ms 0011 =2ms 0100 = 4ms 0101 =8ms 0110 = 16ms 0111 = 32ms 1000 = 64ms 1001 =128ms;1010 =256ms;1011 =512ms 1100 = 1024ms 1101 =1024ms 1110 = 1024ms 1111 = 1024ms			
RSVD2	7	R	0h	N/A (Hard-coded)
	Reserved			

## 92HD99

### SINGLE CHIP PC AUDIO SYSTEM, CODEC+SPEAKER AMPLIFIER+CAPLESS HP+LDO

Field Name	Bits	R/W	Default	Reset
t_long_realtime_detect	6:4	RW	5h	POR
	000 = 2s 001 =4s 010 =8s 011 =16s 100 = 32s 101 =64s 110 = 128s 111 = infinite			
RSVD1	3	R	0h	N/A (Hard-coded)
	Reserved			
t_delay_verfout	2:0	RW	3h	POR
	000 = 0.1ms 001 =50ms 010 = 125ms 011 =250ms 100 = 500ms 101 = 1s 110 = 2s 111 = 4s			

## 7.5. PortA (NID = 0Ah): WCap

Reg	Byte 4 (Bits 31:24)	Byte 3 (Bits 23:16)	Byte 2 (Bits 15:8)	Byte 1 (Bits 7:0)
Set				
Get	F0009h			

Field Name	Bits	R/W	Default	Reset
Rsvd2	31:24	R	00h	N/A (Hard-coded)
	Reserved.			
Type	23:20	R	4h	N/A (Hard-coded)
	Widget type: 0h = Out Converter 1h = In Converter 2h = Summing (Mixer) 3h = Selector (Mux) 4h = Pin Complex 5h = Power 6h = Volume Knob 7h = Beep Generator 8h-Eh = Reserved Fh = Vendor Defined			
Delay	19:16	R	0h	N/A (Hard-coded)
	Number of sample delays through widget.			
Rsvd1	15:12	R	0h	N/A (Hard-coded)
	Reserved.			
SwapCap	11	R	0h	N/A (Hard-coded)
	Left/right swap support: 1 = yes, 0 = no.			
PwrCntrl	10	R	1h	N/A (Hard-coded)
	Power state support: 1 = yes, 0 = no.			
Dig	9	R	0h	N/A (Hard-coded)
	Digital stream support: 1 = yes (digital), 0 = no (analog).			
ConnList	8	R	1h	N/A (Hard-coded)
	Connection list present: 1 = yes, 0 = no.			
UnSolCap	7	R	1h	N/A (Hard-coded)
	Unsolicited response support: 1 = yes, 0 = no.			

Field Name	Bits	R/W	Default	Reset
ProcWidget	6	R	0h	N/A (Hard-coded)
	Processing state support: 1 = yes, 0 = no.			
Stripe	5	R	0h	N/A (Hard-coded)
	Striping support: 1 = yes, 0 = no.			
FormatOvr	4	R	0h	N/A (Hard-coded)
	Stream format override: 1 = yes, 0 = no.			
AmpParOvr	3	R	0h	N/A (Hard-coded)
	Amplifier capabilities override: 1 = yes, no.			
OutAmpPrsnt	2	R	0h	N/A (Hard-coded)
	Output amp present: 1 = yes, 0 = no.			
InAmpPrsnt	1	R	1h	N/A (Hard-coded)
	Input amp present: 1 = yes, 0 = no.			
Stereo	0	R	1h	N/A (Hard-coded)
	Stereo stream support: 1 = yes (stereo), 0 = no (mono).			

### 7.5.1. PortA (NID = 0Ah): PinCap

Reg	Byte 4 (Bits 31:24)	Byte 3 (Bits 23:16)	Byte 2 (Bits 15:8)	Byte 1 (Bits 7:0)
Set				
Get	F000Ch			

Field Name	Bits	R/W	Default	Reset
Rsvd2	31:17	R	0000h	N/A (Hard-coded)
	Reserved.			
EapdCap	16	R	1h	N/A (Hard-coded)
	EAPD support: 1 = yes, 0 = no.			



Field Name	Bits	R/W	Default	Reset
VrefCntrl	15:8	R	17h	N/A (Hard-coded)
	Vref support: bit 7 = Reserved bit 6 = Reserved bit 5 = 100% support (1 = yes, 0 = no) bit 4 = 80% support (1 = yes, 0 = no) bit 3 = Reserved bit 2 = GND support (1 = yes, 0 = no) bit 1 = 50% support (1 = yes, 0 = no) bit 0 = Hi-Z support (1 = yes, 0 = no)			
Rsvd1	7	R	0h	N/A (Hard-coded)
	Reserved.			
BalancedIO	6	R	0h	N/A (Hard-coded)
	Balanced I/O support: 1 = yes, 0 = no.			
InCap	5	R	1h	N/A (Hard-coded)
	Input support: 1 = yes, 0 = no.			
OutCap	4	R	1h	N/A (Hard-coded)
	Output support: 1 = yes, 0 = no.			
HdphDrvCap	3	R	1h	N/A (Hard-coded)
	Headphone amp present: 1 = yes, 0 = no.			
PresDtctCap	2	R	1h	N/A (Hard-coded)
	Presence detection support: 1 = yes, 0 = no.			
TrigRqd	1	R	0h	N/A (Hard-coded)
	Trigger required for impedance sense: 1 = yes, 0 = no.			
ImpSenseCap	0	R	0h	N/A (Hard-coded)
	Impedance sense support: 1 = yes, 0 = no.			

### 7.5.2. PortA (NID = 0Ah): ConLst

Reg	Byte 4 (Bits 31:24)	Byte 3 (Bits 23:16)	Byte 2 (Bits 15:8)	Byte 1 (Bits 7:0)
Set				
Get	F000Eh			

Field Name	Bits	R/W	Default	Reset
Rsvd	31:8	R	000000h	N/A (Hard-coded)
	Reserved.			
LForm	7	R	0h	N/A (Hard-coded)
	Connection list format: 1 = long-form (15-bit) NID entries, 0 = short-form (7-bit) NID entries.			
ConL	6:0	R	03h	N/A (Hard-coded)
	Number of NID entries in connection list.			

### 7.5.3. PortA (NID = 0Ah): ConLstEntry0

Reg	Byte 4 (Bits 31:24)	Byte 3 (Bits 23:16)	Byte 2 (Bits 15:8)	Byte 1 (Bits 7:0)
Set				
Get	F0200h			

Field Name	Bits	R/W	Default	Reset
ConL3	31:24	R	00h	N/A (Hard-coded)
	DAC2 Converter widget (0x22)			
ConL2	23:16	R	1Ch	N/A (Hard-coded)
	MixerOutVol Selector widget (0x1C)			
ConL1	15:8	R	14h	N/A (Hard-coded)
	DAC1 Converter widget (0x14)			
ConL0	7:0	R	13h	N/A (Hard-coded)
	DAC0 Converter widget (0x13)			

### 7.5.4. PortA (NID = 0Ah): InAmpLeft

Reg	Byte 4 (Bits 31:24)	Byte 3 (Bits 23:16)	Byte 2 (Bits 15:8)	Byte 1 (Bits 7:0)
Set				360h
Get	B2000h			

Field Name	Bits	R/W	Default	Reset
Rsvd1	31:2	R	00000000h	N/A (Hard-coded)
	Reserved.			
Gain	1:0	RW	0h	POR - DAFG - ULR
	Amp gain step number (see InAmpCap parameter pertaining to this widget).			

#### 7.5.5. PortA (NID = 0Ah): InAmpRight

Reg	Byte 4 (Bits 31:24)	Byte 3 (Bits 23:16)	Byte 2 (Bits 15:8)	Byte 1 (Bits 7:0)
Set				350h
Get	B0000h			

Field Name	Bits	R/W	Default	Reset
Rsvd1	31:2	R	00000000h	N/A (Hard-coded)
	Reserved.			
Gain	1:0	RW	0h	POR - DAFG - ULR
	Amp gain step number (see InAmpCap parameter pertaining to this widget).			

#### 7.5.6. PortA (NID = 0Ah): ConSelectCtrl

Reg	Byte 4 (Bits 31:24)	Byte 3 (Bits 23:16)	Byte 2 (Bits 15:8)	Byte 1 (Bits 7:0)
Set				701h
Get	F0100h			

Field Name	Bits	R/W	Default	Reset
Rsvd	31:2	R	00000000h	N/A (Hard-coded)
	Reserved.			
Index	1:0	RW	0h	POR - DAFG - ULR
	Connection select control index.			

**7.5.7. PortA (NID = 0Ah): PwrState**

Reg	Byte 4 (Bits 31:24)	Byte 3 (Bits 23:16)	Byte 2 (Bits 15:8)	Byte 1 (Bits 7:0)
Set				705h
Get	F0500h			

Field Name	Bits	R/W	Default	Reset
Rsvd4	31:11	R	000000h	N/A (Hard-coded)
	Reserved.			
SettingsReset	10	R	1h	POR - DAFG - ULR
	Indicates if any persistent settings in this Widget have been reset. Cleared by PwrState 'Get', or a 'Set' to any Verb in this Widget.			
Rsvd3	9	R	0h	N/A (Hard-coded)
	Reserved.			
Error	8	R	0h	POR - DAFG - ULR
	Error indicator: 1 = cannot enter requested power state, 0 = no problem with requested power state.			
Rsvd2	7:6	R	0h	N/A (Hard-coded)
	Reserved.			
Act	5:4	R	3h	POR - DAFG - LR
	Actual power state of this widget.			
Rsvd1	3:2	R	0h	N/A (Hard-coded)
	Reserved.			
Set	1:0	RW	0h	POR - DAFG - LR
	Current power state setting for this widget.			

**7.5.8. PortA (NID = 0Ah): PinWCntrl**

Reg	Byte 4 (Bits 31:24)	Byte 3 (Bits 23:16)	Byte 2 (Bits 15:8)	Byte 1 (Bits 7:0)
Set				707h
Get	F0700h			

Field Name	Bits	R/W	Default	Reset
Rsvd2	31:8	R	000000h	N/A (Hard-coded)
	Reserved.			
HPhnEn	7	RW	0h	POR - DAFG - ULR
	Headphone amp enable: 1 = enabled, 0 = disabled.			
OutEn	6	RW	0h	POR - DAFG - ULR
	Output enable: 1 = enabled, 0 = disabled.			
InEn	5	RW	0h	POR - DAFG - ULR
	Input enable: 1 = enabled, 0 = disabled.			
Rsvd1	4:3	R	0h	N/A (Hard-coded)
	Reserved.			
VRefEn	2:0	RW	0h	POR - DAFG - ULR
	Vref selection (See VrefCntrl field of PinCap parameter for supported selections): 000b= HI-Z 001b= 50% 010b= GND 011b= Reserved 100b= 80% 101b= 100% 110b= Reserved 111b= Reserved			

**7.5.9. PortA (NID = 0Ah): UnsolResp**

Reg	Byte 4 (Bits 31:24)	Byte 3 (Bits 23:16)	Byte 2 (Bits 15:8)	Byte 1 (Bits 7:0)
Set				708h
Get	F0800h			

Field Name	Bits	R/W	Default	Reset
Rsvd2	31:8	R	000000h	N/A (Hard-coded)
	Reserved.			

Field Name	Bits	R/W	Default	Reset
En	7	RW	0h	POR - DAFG - ULR
	Unsolicited response enable (also enables Wake events for this Widget): 1 = enabled, 0 = disabled.			
Rsvd1	6	R	0h	N/A (Hard-coded)
	Reserved.			
Tag	5:0	RW	00h	POR - DAFG - ULR
	Software programmable field returned in top six bits (31:26) of every Unsolicited Response generated by this node.			

#### 7.5.10. PortA (NID = 0Ah): ChSense

Reg	Byte 4 (Bits 31:24)	Byte 3 (Bits 23:16)	Byte 2 (Bits 15:8)	Byte 1 (Bits 7:0)
Set				709h
Get	F0900h			

Field Name	Bits	R/W	Default	Reset
PresDtct	31	R	0h	POR
	Presence detection indicator: 1 = presence detected; 0 = presence not detected.			
Rsvd	30:0	R	00000000h	N/A (Hard-coded)
	Reserved.			

#### 7.5.11. PortA (NID = 0Ah): EAPDBTLLR

Reg	Byte 4 (Bits 31:24)	Byte 3 (Bits 23:16)	Byte 2 (Bits 15:8)	Byte 1 (Bits 7:0)
Set				70Ch
Get	F0C00h			

Field Name	Bits	R/W	Default	Reset
Rsvd2	31:2	R	00000000h	N/A (Hard-coded)
	Reserved.			

Field Name	Bits	R/W	Default	Reset
EAPD	1	RW	1h	POR - DAFG - ULR
	EAPD control: 1 = set EAPD pin to 1 (powered) up if this pin is powered up, 0 = set EAPD pin to 0.			
Rsvd1	0	R	0h	N/A (Hard-coded)
	Reserved.			

**7.5.12. PortA (NID = 0Ah): ConfigDefault**

Reg	Byte 4 (Bits 31:24)	Byte 3 (Bits 23:16)	Byte 2 (Bits 15:8)	Byte 1 (Bits 7:0)
Set	71Fh	71Eh	71Dh	71Ch
Get	F1F00h / F1E00h / F1D00h / F1C00h			

Field Name	Bits	R/W	Default	Reset
PortConnectivity	31:30	RW	0h	POR
	Port connectivity: 0h = Port complex is connected to a jack 1h = No physical connection for port 2h = Fixed function device is attached 3h = Both jack and internal device attached (info in all other fields refers to integrated device, any presence detection refers to jack)			
Location	29:24	RW	02h	POR
	Location  Bits [5..4]: 0h = External on primary chassis 1h = Internal 2h = Separate chassis 3h = Other  Bits [3..0]: 0h = N/A 1h = Rear 2h = Front 3h = Left 4h = Right 5h = Top 6h = Bottom 7h-9h = Special Ah-Fh = Reserved			

**92HD99****SINGLE CHIP PC AUDIO SYSTEM, CODEC+SPEAKER AMPLIFIER+CAPLESS HP+LDO**

Field Name	Bits	R/W	Default	Reset
Device	23:20	RW	Ah	POR
Default device: 0h = Line out 1h = Speaker 2h = HP out 3h = CD 4h = SPDIF Out 5h = Digital other out 6h = Modem line side 7h = Modem handset side 8h = Line in 9h = Aux Ah = Mic in Bh = Telephony Ch = SPDIF In Dh = Digital other in Eh = Reserved Fh = Other				
ConnectionType	19:16	RW	1h	POR
Connection type: 0h = Unknown 1h = 1/8" stereo/mono 2h = 1/4" stereo/mono 3h = ATAPI internal 4h = RCA 5h = Optical 6h = Other digital 7h = Other analog 8h = Multichannel analog (DIN) 9h = XLR/Professional Ah = RJ-11 (modem) Bh = Combination Ch-Eh = Reserved Fh = Other				



# 92HD99

## SINGLE CHIP PC AUDIO SYSTEM, CODEC+SPEAKER AMPLIFIER+CAPLESS HP+LDO

Field Name	Bits	R/W	Default	Reset
Color	15:12	RW	9h	POR
	Color: 0h = Unknown 1h = Black 2h = Grey 3h = Blue 4h = Green 5h = Red 6h = Orange 7h = Yellow 8h = Purple 9h = Pink Ah-Dh = Reserved Eh = White Fh = Other			
Misc	11:8	RW	0h	POR
	Miscellaneous: Bits [3..1] = Reserved Bit 0 = Jack detect override			
Association	7:4	RW	2h	POR
	Default association.			
Sequence	3:0	RW	Fh	POR
	Sequence.			

### 7.6. PortB (NID = 0Bh): WCap

Reg	Byte 4 (Bits 31:24)	Byte 3 (Bits 23:16)	Byte 2 (Bits 15:8)	Byte 1 (Bits 7:0)
Set				
Get	F0009h			

Field Name	Bits	R/W	Default	Reset
Rsvd2	31:24	R	00h	N/A (Hard-coded)
	Reserved.			

# 92HD99

## SINGLE CHIP PC AUDIO SYSTEM, CODEC+SPEAKER AMPLIFIER+CAPLESS HP+LDO

Field Name	Bits	R/W	Default	Reset
Type	23:20	R	4h	N/A (Hard-coded)
Widget type: 0h = Out Converter 1h = In Converter 2h = Summing (Mixer) 3h = Selector (Mux) 4h = Pin Complex 5h = Power 6h = Volume Knob 7h = Beep Generator 8h-Eh = Reserved Fh = Vendor Defined				
Delay	19:16	R	0h	N/A (Hard-coded)
Number of sample delays through widget.				
Rsvd1	15:12	R	0h	N/A (Hard-coded)
Reserved.				
SwapCap	11	R	0h	N/A (Hard-coded)
Left/right swap support: 1 = yes, 0 = no.				
PwrCntrl	10	R	1h	N/A (Hard-coded)
Power state support: 1 = yes, 0 = no.				
Dig	9	R	0h	N/A (Hard-coded)
Digital stream support: 1 = yes (digital), 0 = no (analog).				
ConnList	8	R	1h	N/A (Hard-coded)
Connection list present: 1 = yes, 0 = no.				
UnSolCap	7	R	1h	N/A (Hard-coded)
Unsolicited response support: 1 = yes, 0 = no.				
ProcWidget	6	R	0h	N/A (Hard-coded)
Processing state support: 1 = yes, 0 = no.				
Stripe	5	R	0h	N/A (Hard-coded)
Striping support: 1 = yes, 0 = no.				
FormatOvrd	4	R	0h	N/A (Hard-coded)
Stream format override: 1 = yes, 0 = no.				

## 92HD99

### SINGLE CHIP PC AUDIO SYSTEM, CODEC+SPEAKER AMPLIFIER+CAPLESS HP+LDO

Field Name	Bits	R/W	Default	Reset
AmpParOvrd	3	R	0h	N/A (Hard-coded)
Amplifier capabilities override: 1 = yes, no.				
OutAmpPrsnt	2	R	0h	N/A (Hard-coded)
Output amp present: 1 = yes, 0 = no.				
InAmpPrsnt	1	R	0h	N/A (Hard-coded)
Input amp present: 1 = yes, 0 = no.				
Stereo	0	R	1h	N/A (Hard-coded)
Stereo stream support: 1 = yes (stereo), 0 = no (mono).				

#### 7.6.1. PortB (NID = 0Bh): PinCap

Reg	Byte 4 (Bits 31:24)	Byte 3 (Bits 23:16)	Byte 2 (Bits 15:8)	Byte 1 (Bits 7:0)
Set				
Get	F000Ch			

Field Name	Bits	R/W	Default	Reset
Rsvd2	31:17	R	0000h	N/A (Hard-coded)
Reserved.				
EapdCap	16	R	1h	N/A (Hard-coded)
EAPD support: 1 = yes, 0 = no.				
VrefCntrl	15:8	R	00h	N/A (Hard-coded)
Vref support: bit 7 = Reserved bit 6 = Reserved bit 5 = 100% support (1 = yes, 0 = no) bit 4 = 80% support (1 = yes, 0 = no) bit 3 = Reserved bit 2 = GND support (1 = yes, 0 = no) bit 1 = 50% support (1 = yes, 0 = no) bit 0 = Hi-Z support (1 = yes, 0 = no)				
Rsvd1	7	R	0h	N/A (Hard-coded)
Reserved.				

Field Name	Bits	R/W	Default	Reset
BalancedIO	6	R	0h	N/A (Hard-coded)
	Balanced I/O support: 1 = yes, 0 = no.			
InCap	5	R	0h	N/A (Hard-coded)
	Input support: 1 = yes, 0 = no.			
OutCap	4	R	1h	N/A (Hard-coded)
	Output support: 1 = yes, 0 = no.			
HdphDrvCap	3	R	1h	N/A (Hard-coded)
	Headphone amp present: 1 = yes, 0 = no.			
PresDtctCap	2	R	1h	N/A (Hard-coded)
	Presence detection support: 1 = yes, 0 = no.			
TrigRqd	1	R	0h	N/A (Hard-coded)
	Trigger required for impedance sense: 1 = yes, 0 = no.			
ImpSenseCap	0	R	0h	N/A (Hard-coded)
	Impedance sense support: 1 = yes, 0 = no.			

### 7.6.2. PortB (NID = 0Bh): ConLst

Reg	Byte 4 (Bits 31:24)	Byte 3 (Bits 23:16)	Byte 2 (Bits 15:8)	Byte 1 (Bits 7:0)
Set				
Get	F000Eh			

Field Name	Bits	R/W	Default	Reset
Rsvd	31:8	R	000000h	N/A (Hard-coded)
	Reserved.			
LForm	7	R	0h	N/A (Hard-coded)
	Connection list format: 1 = long-form (15-bit) NID entries, 0 = short-form (7-bit) NID entries.			
ConL	6:0	R	03h	N/A (Hard-coded)
	Number of NID entries in connection list.			

**7.6.3. PortB (NID = 0Bh): ConLstEntry0**

Reg	Byte 4 (Bits 31:24)	Byte 3 (Bits 23:16)	Byte 2 (Bits 15:8)	Byte 1 (Bits 7:0)
Set				
Get	F0200h			

Field Name	Bits	R/W	Default	Reset
ConL3	31:24	R	00h	N/A (Hard-coded)
	DAC2 Converter widget (0x22)			
ConL2	23:16	R	1Ch	N/A (Hard-coded)
	MixerOutVol Selector widget (0x1C)			
ConL1	15:8	R	14h	N/A (Hard-coded)
	DAC1 Converter widget (0x14)			
ConL0	7:0	R	13h	N/A (Hard-coded)
	DAC0 Converter widget (0x13)			

**7.6.4. PortB (NID = 0Bh): ConSelectCtrl**

Reg	Byte 4 (Bits 31:24)	Byte 3 (Bits 23:16)	Byte 2 (Bits 15:8)	Byte 1 (Bits 7:0)
Set				701h
Get	F0100h			

Field Name	Bits	R/W	Default	Reset
Rsvd	31:2	R	00000000h	N/A (Hard-coded)
	Reserved.			
Index	1:0	RW	0h	POR - DAFG - ULR
	Connection select control index.			

**7.6.5. PortB (NID = 0Bh): PwrState**

Reg	Byte 4 (Bits 31:24)	Byte 3 (Bits 23:16)	Byte 2 (Bits 15:8)	Byte 1 (Bits 7:0)
Set				705h
Get	F0500h			

Field Name	Bits	R/W	Default	Reset
Rsvd4	31:11	R	000000h	N/A (Hard-coded)
	Reserved.			
SettingsReset	10	R	1h	POR - DAFG - ULR
	Indicates if any persistent settings in this Widget have been reset. Cleared by PwrState 'Get', or a 'Set' to any Verb in this Widget.			
Rsvd3	9	R	0h	N/A (Hard-coded)
	Reserved.			
Error	8	R	0h	POR - DAFG - ULR
	Error indicator: 1 = cannot enter requested power state, 0 = no problem with requested power state.			
Rsvd2	7:6	R	0h	N/A (Hard-coded)
	Reserved.			
Act	5:4	R	3h	POR - DAFG - LR
	Actual power state of this widget.			
Rsvd1	3:2	R	0h	N/A (Hard-coded)
	Reserved.			
Set	1:0	RW	0h	POR - DAFG - LR
	Current power state setting for this widget.			

#### 7.6.6. PortB (NID = 0Bh): PinWCntrl

Reg	Byte 4 (Bits 31:24)	Byte 3 (Bits 23:16)	Byte 2 (Bits 15:8)	Byte 1 (Bits 7:0)
Set				707h
Get	F0700h			

Field Name	Bits	R/W	Default	Reset
Rsvd2	31:8	R	000000h	N/A (Hard-coded)
	Reserved.			
HPhnEn	7	RW	0h	POR - DAFG - ULR
	Headphone amp enable: 1 = enabled, 0 = disabled.			

Field Name	Bits	R/W	Default	Reset
OutEn	6	RW	0h	POR - DAFG - ULR
	Output enable: 1 = enabled, 0 = disabled.			
Rsvd1	5:0	RW	00h	N/A (Hard-coded)
	Reserved.			

### 7.6.7. PortB (NID = 0Bh): UnsolResp

Reg	Byte 4 (Bits 31:24)	Byte 3 (Bits 23:16)	Byte 2 (Bits 15:8)	Byte 1 (Bits 7:0)
Set				708h
Get	F0800h			

Field Name	Bits	R/W	Default	Reset
Rsvd2	31:8	R	000000h	N/A (Hard-coded)
	Reserved.			
En	7	RW	0h	POR - DAFG - ULR
	Unsolicited response enable (also enables Wake events for this Widget): 1 = enabled, 0 = disabled.			
Rsvd1	6	R	0h	N/A (Hard-coded)
	Reserved.			
Tag	5:0	RW	00h	POR - DAFG - ULR
	Software programmable field returned in top six bits (31:26) of every Unsolicited Response generated by this node.			

### 7.6.8. PortB (NID = 0Bh): ChSense

Reg	Byte 4 (Bits 31:24)	Byte 3 (Bits 23:16)	Byte 2 (Bits 15:8)	Byte 1 (Bits 7:0)
Set				709h
Get	F0900h			

Field Name	Bits	R/W	Default	Reset
PresDtct	31	R	0h	POR
	Presence detection indicator: 1 = presence detected; 0 = presence not detected.			
Rsvd	30:0	R	00000000h	N/A (Hard-coded)
	Reserved.			

### 7.6.9. PortB (NID = 0Bh): EAPDBTLLR

Reg	Byte 4 (Bits 31:24)	Byte 3 (Bits 23:16)	Byte 2 (Bits 15:8)	Byte 1 (Bits 7:0)
Set				70Ch
Get	F0C00h			

Field Name	Bits	R/W	Default	Reset
Rsvd2	31:2	R	00000000h	N/A (Hard-coded)
	Reserved.			
EAPD	1	RW	1h	POR - DAFG - ULR
	EAPD control: 1 = set EAPD pin to 1 (powered) up if this pin is powered up, 0 = set EAPD pin to 0.			
Rsvd1	0	R	0h	N/A (Hard-coded)
	Reserved.			

### 7.6.10. PortB (NID = 0Bh): ConfigDefault

Reg	Byte 4 (Bits 31:24)	Byte 3 (Bits 23:16)	Byte 2 (Bits 15:8)	Byte 1 (Bits 7:0)
Set	71Fh	71Eh	71Dh	71Ch
Get	F1F00h / F1E00h / F1D00h / F1C00h			



**92HD99**

**SINGLE CHIP PC AUDIO SYSTEM, CODEC+SPEAKER AMPLIFIER+CAPLESS HP+LDO**

Field Name	Bits	R/W	Default	Reset
PortConnectivity	31:30	RW	0h	POR
Port connectivity: 0h = Port complex is connected to a jack 1h = No physical connection for port 2h = Fixed function device is attached 3h = Both jack and internal device attached (info in all other fields refers to integrated device, any presence detection refers to jack)				
Location	29:24	RW	02h	POR
Location  Bits [5..4]: 0h = External on primary chassis 1h = Internal 2h = Separate chassis 3h = Other  Bits [3..0]: 0h = N/A 1h = Rear 2h = Front 3h = Left 4h = Right 5h = Top 6h = Bottom 7h-9h = Special Ah-Fh = Reserved				
Device	23:20	RW	2h	POR
Default device: 0h = Line out 1h = Speaker 2h = HP out 3h = CD 4h = SPDIF Out 5h = Digital other out 6h = Modem line side 7h = Modem handset side 8h = Line in 9h = Aux Ah = Mic in Bh = Telephony Ch = SPDIF In Dh = Digital other in Eh = Reserved Fh = Other				

**92HD99**

**SINGLE CHIP PC AUDIO SYSTEM, CODEC+SPEAKER AMPLIFIER+CAPLESS HP+LDO**

Field Name	Bits	R/W	Default	Reset
ConnectionType	19:16	RW	1h	POR
	Connection type: 0h = Unknown 1h = 1/8" stereo/mono 2h = 1/4" stereo/mono 3h = ATAPI internal 4h = RCA 5h = Optical 6h = Other digital 7h = Other analog 8h = Multichannel analog (DIN) 9h = XLR/Professional Ah = RJ-11 (modem) Bh = Combination Ch-Eh = Reserved Fh = Other			
Color	15:12	RW	4h	POR
	Color: 0h = Unknown 1h = Black 2h = Grey 3h = Blue 4h = Green 5h = Red 6h = Orange 7h = Yellow 8h = Purple 9h = Pink Ah-Dh = Reserved Eh = White Fh = Other			
Misc	11:8	RW	0h	POR
	Miscellaneous: Bits [3..1] = Reserved Bit 0 = Jack detect override			
Association	7:4	RW	1h	POR
	Default association.			
Sequence	3:0	RW	Fh	POR
	Sequence.			

## 7.7. PortC (NID = 0Ch): WCap

Reg	Byte 4 (Bits 31:24)	Byte 3 (Bits 23:16)	Byte 2 (Bits 15:8)	Byte 1 (Bits 7:0)
Set				
Get	F0009h			

Field Name	Bits	R/W	Default	Reset
Rsvd2	31:24	R	00h	N/A (Hard-coded)
	Reserved.			
Type	23:20	R	4h	N/A (Hard-coded)
	Widget type: 0h = Out Converter 1h = In Converter 2h = Summing (Mixer) 3h = Selector (Mux) 4h = Pin Complex 5h = Power 6h = Volume Knob 7h = Beep Generator 8h-Eh = Reserved Fh = Vendor Defined			
Delay	19:16	R	0h	N/A (Hard-coded)
	Number of sample delays through widget.			
Rsvd1	15:12	R	0h	N/A (Hard-coded)
	Reserved.			
SwapCap	11	R	0h	N/A (Hard-coded)
	Left/right swap support: 1 = yes, 0 = no.			
PwrCntrl	10	R	1h	N/A (Hard-coded)
	Power state support: 1 = yes, 0 = no.			
Dig	9	R	0h	N/A (Hard-coded)
	Digital stream support: 1 = yes (digital), 0 = no (analog).			
ConnList	8	R	1h	N/A (Hard-coded)
	Connection list present: 1 = yes, 0 = no.			
UnSolCap	7	R	1h	N/A (Hard-coded)
	Unsolicited response support: 1 = yes, 0 = no.			

## 92HD99

### SINGLE CHIP PC AUDIO SYSTEM, CODEC+SPEAKER AMPLIFIER+CAPLESS HP+LDO

Field Name	Bits	R/W	Default	Reset
ProcWidget	6	R	0h	N/A (Hard-coded)
	Processing state support: 1 = yes, 0 = no.			
Stripe	5	R	0h	N/A (Hard-coded)
	Striping support: 1 = yes, 0 = no.			
FormatOvr	4	R	0h	N/A (Hard-coded)
	Stream format override: 1 = yes, 0 = no.			
AmpParOvr	3	R	0h	N/A (Hard-coded)
	Amplifier capabilities override: 1 = yes, no.			
OutAmpPrsnt	2	R	0h	N/A (Hard-coded)
	Output amp present: 1 = yes, 0 = no.			
InAmpPrsnt	1	R	1h	N/A (Hard-coded)
	Input amp present: 1 = yes, 0 = no.			
Stereo	0	R	1h	N/A (Hard-coded)
	Stereo stream support: 1 = yes (stereo), 0 = no (mono).			

#### 7.7.1. PortC (NID = 0Ch): PinCap

Reg	Byte 4 (Bits 31:24)	Byte 3 (Bits 23:16)	Byte 2 (Bits 15:8)	Byte 1 (Bits 7:0)
Set				
Get	F000Ch			

Field Name	Bits	R/W	Default	Reset
Rsvd2	31:17	R	0000h	N/A (Hard-coded)
	Reserved.			
EapdCap	16	R	1h	N/A (Hard-coded)
	EAPD support: 1 = yes, 0 = no.			

# 92HD99

## SINGLE CHIP PC AUDIO SYSTEM, CODEC+SPEAKER AMPLIFIER+CAPLESS HP+LDO

Field Name	Bits	R/W	Default	Reset
VrefCntrl	15:8	R	17h	N/A (Hard-coded)
	Vref support: bit 7 = Reserved bit 6 = Reserved bit 5 = 100% support (1 = yes, 0 = no) bit 4 = 80% support (1 = yes, 0 = no) bit 3 = Reserved bit 2 = GND support (1 = yes, 0 = no) bit 1 = 50% support (1 = yes, 0 = no) bit 0 = Hi-Z support (1 = yes, 0 = no)			
Rsvd1	7	R	0h	N/A (Hard-coded)
	Reserved.			
BalancedIO	6	R	0h	N/A (Hard-coded)
	Balanced I/O support: 1 = yes, 0 = no.			
InCap	5	R	1h	N/A (Hard-coded)
	Input support: 1 = yes, 0 = no.			
OutCap	4	R	1h	N/A (Hard-coded)
	Output support: 1 = yes, 0 = no.			
HdphDrvCap	3	R	0h	N/A (Hard-coded)
	Headphone amp present: 1 = yes, 0 = no.			
PresDtctCap	2	R	1h	N/A (Hard-coded)
	Presence detection support: 1 = yes, 0 = no.			
TrigRqd	1	R	0h	N/A (Hard-coded)
	Trigger required for impedance sense: 1 = yes, 0 = no.			
ImpSenseCap	0	R	0h	N/A (Hard-coded)
	Impedance sense support: 1 = yes, 0 = no.			

### 7.7.2. PortC (NID = 0Ch): ConLst

Reg	Byte 4 (Bits 31:24)	Byte 3 (Bits 23:16)	Byte 2 (Bits 15:8)	Byte 1 (Bits 7:0)
Set				
Get	F000Eh			

Field Name	Bits	R/W	Default	Reset
Rsvd	31:8	R	000000h	N/A (Hard-coded)
	Reserved.			
LForm	7	R	0h	N/A (Hard-coded)
	Connection list format: 1 = long-form (15-bit) NID entries, 0 = short-form (7-bit) NID entries.			
ConL	6:0	R	03h	N/A (Hard-coded)
	Number of NID entries in connection list.			

### 7.7.3. PortC (NID = 0Ch): ConLstEntry0

Reg	Byte 4 (Bits 31:24)	Byte 3 (Bits 23:16)	Byte 2 (Bits 15:8)	Byte 1 (Bits 7:0)
Set				
Get	F0200h			

Field Name	Bits	R/W	Default	Reset
ConL3	31:24	R	00h	N/A (Hard-coded)
	Reserved			
ConL2	23:16	R	1Ch	N/A (Hard-coded)
	MixerOutVol Selector widget (0x1C)			
ConL1	15:8	R	14h	N/A (Hard-coded)
	DAC1 Converter widget (0x14)			
ConL0	7:0	R	13h	N/A (Hard-coded)
	DAC0 Converter widget (0x13)			

### 7.7.4. PortC (NID = 0Ch): InAmpLeft

Reg	Byte 4 (Bits 31:24)	Byte 3 (Bits 23:16)	Byte 2 (Bits 15:8)	Byte 1 (Bits 7:0)
Set				360h
Get	B2000h			

Field Name	Bits	R/W	Default	Reset
Rsvd1	31:2	R	00000000h	N/A (Hard-coded)
	Reserved.			
Gain	1:0	RW	0h	POR - DAFG - ULR
	Amp gain step number (see InAmpCap parameter pertaining to this widget).			

### 7.7.5. PortC (NID = 0Ch): InAmpRight

Reg	Byte 4 (Bits 31:24)	Byte 3 (Bits 23:16)	Byte 2 (Bits 15:8)	Byte 1 (Bits 7:0)
Set				350h
Get	B0000h			

Field Name	Bits	R/W	Default	Reset
Rsvd1	31:2	R	00000000h	N/A (Hard-coded)
	Reserved.			
Gain	1:0	RW	0h	POR - DAFG - ULR
	Amp gain step number (see InAmpCap parameter pertaining to this widget).			

### 7.7.6. PortC (NID = 0Ch): ConSelectCtrl

Reg	Byte 4 (Bits 31:24)	Byte 3 (Bits 23:16)	Byte 2 (Bits 15:8)	Byte 1 (Bits 7:0)
Set				701h
Get	F0100h			

Field Name	Bits	R/W	Default	Reset
Rsvd	31:2	R	00000000h	N/A (Hard-coded)
	Reserved.			
Index	1:0	RW	0h	POR - DAFG - ULR
	Connection select control index.			

**7.7.7. PortC (NID = 0Ch): PwrState**

Reg	Byte 4 (Bits 31:24)	Byte 3 (Bits 23:16)	Byte 2 (Bits 15:8)	Byte 1 (Bits 7:0)
Set				705h
Get	F0500h			

Field Name	Bits	R/W	Default	Reset
Rsvd4	31:11	R	000000h	N/A (Hard-coded)
	Reserved.			
SettingsReset	10	R	1h	POR - DAFG - ULR
	Indicates if any persistent settings in this Widget have been reset. Cleared by PwrState 'Get', or a 'Set' to any Verb in this Widget.			
Rsvd3	9	R	0h	N/A (Hard-coded)
	Reserved.			
Error	8	R	0h	POR - DAFG - ULR
	Error indicator: 1 = cannot enter requested power state, 0 = no problem with requested power state.			
Rsvd2	7:6	R	0h	N/A (Hard-coded)
	Reserved.			
Act	5:4	R	3h	POR - DAFG - LR
	Actual power state of this widget.			
Rsvd1	3:2	R	0h	N/A (Hard-coded)
	Reserved.			
Set	1:0	RW	0h	POR - DAFG - LR
	Current power state setting for this widget.			

**7.7.8. PortC (NID = 0Ch): PinWCntrl**

Reg	Byte 4 (Bits 31:24)	Byte 3 (Bits 23:16)	Byte 2 (Bits 15:8)	Byte 1 (Bits 7:0)
Set				707h
Get	F0700h			



Field Name	Bits	R/W	Default	Reset
Rsvd2	31:7	R	000000h	N/A (Hard-coded)
	Reserved.			
OutEn	6	RW	0h	POR - DAFG - ULR
	Output enable: 1 = enabled, 0 = disabled.			
InEn	5	RW	0h	POR - DAFG - ULR
	Input enable: 1 = enabled, 0 = disabled.			
Rsvd1	4:3	R	0h	N/A (Hard-coded)
	Reserved.			
VRefEn	2:0	RW	0h	POR - DAFG - ULR
	Vref selection (See VrefCntrl field of PinCap parameter for supported selections): 000b= HI-Z 001b= 50% 010b= GND 011b= Reserved 100b= 80% 101b= 100% 110b= Reserved 111b= Reserved			

### 7.7.9. PortC (NID = 0Ch): UnsolResp

Reg	Byte 4 (Bits 31:24)	Byte 3 (Bits 23:16)	Byte 2 (Bits 15:8)	Byte 1 (Bits 7:0)
Set				708h
Get	F0800h			

Field Name	Bits	R/W	Default	Reset
Rsvd2	31:8	R	000000h	N/A (Hard-coded)
	Reserved.			
En	7	RW	0h	POR - DAFG - ULR
	Unsolicted response enable (also enables Wake events for this Widget): 1 = enabled, 0 = disabled.			

Field Name	Bits	R/W	Default	Reset
Rsvd1	6	R	0h	N/A (Hard-coded)
	Reserved.			
Tag	5:0	RW	00h	POR - DAFG - ULR
	Software programmable field returned in top six bits (31:26) of every Unsolicited Response generated by this node.			

#### 7.7.10. PortC (NID = 0Ch): ChSense

Reg	Byte 4 (Bits 31:24)	Byte 3 (Bits 23:16)	Byte 2 (Bits 15:8)	Byte 1 (Bits 7:0)
Set				709h
Get	F0900h			

Field Name	Bits	R/W	Default	Reset
PresDtct	31	R	0h	POR
	Presence detection indicator: 1 = presence detected; 0 = presence not detected.			
Rsvd	30:0	R	00000000h	N/A (Hard-coded)
	Reserved.			

#### 7.7.11. PortC (NID = 0Ch): EAPDBTLLR

Reg	Byte 4 (Bits 31:24)	Byte 3 (Bits 23:16)	Byte 2 (Bits 15:8)	Byte 1 (Bits 7:0)
Set				70Ch
Get	F0C00h			

Field Name	Bits	R/W	Default	Reset
Rsvd2	31:2	R	00000000h	N/A (Hard-coded)
	Reserved.			
EAPD	1	RW	1h	POR - DAFG - ULR
	EAPD control: 1 = set EAPD pin to 1 (powered) up if this pin is powered up, 0 = set EAPD pin to 0.			

Field Name	Bits	R/W	Default	Reset
Rsvd1	0	R	0h	N/A (Hard-coded)
	Reserved.			

### 7.7.12. PortC (NID = 0Ch): ConfigDefault

Reg	Byte 4 (Bits 31:24)	Byte 3 (Bits 23:16)	Byte 2 (Bits 15:8)	Byte 1 (Bits 7:0)
Set	71Fh	71Eh	71Dh	71Ch
Get	F1F00h / F1E00h / F1D00h / F1C00h			

Field Name	Bits	R/W	Default	Reset
PortConnectivity	31:30	RW	0h	POR
	Port connectivity: 0h = Port complex is connected to a jack 1h = No physical connection for port 2h = Fixed function device is attached 3h = Both jack and internal device attached (info in all other fields refers to integrated device, any presence detection refers to jack)			
Location	29:24	RW	01h	POR
	Location  Bits [5..4]: 0h = External on primary chassis 1h = Internal 2h = Separate chassis 3h = Other  Bits [3..0]: 0h = N/A 1h = Rear 2h = Front 3h = Left 4h = Right 5h = Top 6h = Bottom 7h-9h = Special Ah-Fh = Reserved			

**92HD99****SINGLE CHIP PC AUDIO SYSTEM, CODEC+SPEAKER AMPLIFIER+CAPLESS HP+LDO**

Field Name	Bits	R/W	Default	Reset
Device	23:20	RW	Ah	POR
Default device: 0h = Line out 1h = Speaker 2h = HP out 3h = CD 4h = SPDIF Out 5h = Digital other out 6h = Modem line side 7h = Modem handset side 8h = Line in 9h = Aux Ah = Mic in Bh = Telephony Ch = SPDIF In Dh = Digital other in Eh = Reserved Fh = Other				
ConnectionType	19:16	RW	1h	POR
Connection type: 0h = Unknown 1h = 1/8" stereo/mono 2h = 1/4" stereo/mono 3h = ATAPI internal 4h = RCA 5h = Optical 6h = Other digital 7h = Other analog 8h = Multichannel analog (DIN) 9h = XLR/Professional Ah = RJ-11 (modem) Bh = Combination Ch-Eh = Reserved Fh = Other				

**92HD99****SINGLE CHIP PC AUDIO SYSTEM, CODEC+SPEAKER AMPLIFIER+CAPLESS HP+LDO**

Field Name	Bits	R/W	Default	Reset
Color	15:12	RW	9h	POR
	Color: 0h = Unknown 1h = Black 2h = Grey 3h = Blue 4h = Green 5h = Red 6h = Orange 7h = Yellow 8h = Purple 9h = Pink Ah-Dh = Reserved Eh = White Fh = Other			
Misc	11:8	RW	0h	POR
	Miscellaneous: Bits [3..1] = Reserved Bit 0 = Jack detect override			
Association	7:4	RW	2h	POR
	Default association.			
Sequence	3:0	RW	1h	POR
	Sequence.			

## 7.8. PortD (NID = 0Dh): WCap

Reg	Byte 4 (Bits 31:24)	Byte 3 (Bits 23:16)	Byte 2 (Bits 15:8)	Byte 1 (Bits 7:0)
Set				
Get	F0009h			

Field Name	Bits	R/W	Default	Reset
Rsvd2	31:24	R	00h	N/A (Hard-coded)
	Reserved.			
Type	23:20	R	4h	N/A (Hard-coded)
	Widget type: 0h = Out Converter 1h = In Converter 2h = Summing (Mixer) 3h = Selector (Mux) 4h = Pin Complex 5h = Power 6h = Volume Knob 7h = Beep Generator 8h-Eh = Reserved Fh = Vendor Defined			
Delay	19:16	R	0h	N/A (Hard-coded)
	Number of sample delays through widget.			
Rsvd1	15:12	R	0h	N/A (Hard-coded)
	Reserved.			
SwapCap	11	R	0h	N/A (Hard-coded)
	Left/right swap support: 1 = yes, 0 = no.			
PwrCntrl	10	R	1h	N/A (Hard-coded)
	Power state support: 1 = yes, 0 = no.			
Dig	9	R	0h	N/A (Hard-coded)
	Digital stream support: 1 = yes (digital), 0 = no (analog).			
ConnList	8	R	1h	N/A (Hard-coded)
	Connection list present: 1 = yes, 0 = no.			
UnSolCap	7	R	0h	N/A (Hard-coded)
	Unsolicited response support: 1 = yes, 0 = no.			

Field Name	Bits	R/W	Default	Reset
ProcWidget	6	R	0h	N/A (Hard-coded)
	Processing state support: 1 = yes, 0 = no.			
Stripe	5	R	0h	N/A (Hard-coded)
	Striping support: 1 = yes, 0 = no.			
FormatOvr	4	R	0h	N/A (Hard-coded)
	Stream format override: 1 = yes, 0 = no.			
AmpParOvr	3	R	0h	N/A (Hard-coded)
	Amplifier capabilities override: 1 = yes, no.			
OutAmpPrsnt	2	R	0h	N/A (Hard-coded)
	Output amp present: 1 = yes, 0 = no.			
InAmpPrsnt	1	R	0h	N/A (Hard-coded)
	Input amp present: 1 = yes, 0 = no.			
Stereo	0	R	1h	N/A (Hard-coded)
	Stereo stream support: 1 = yes (stereo), 0 = no (mono).			

### 7.8.1. PortD (NID = 0Dh): PinCap

Reg	Byte 4 (Bits 31:24)	Byte 3 (Bits 23:16)	Byte 2 (Bits 15:8)	Byte 1 (Bits 7:0)
Set				
Get	F000Ch			

Field Name	Bits	R/W	Default	Reset
Rsvd2	31:17	R	0000h	N/A (Hard-coded)
	Reserved.			
EapdCap	16	R	1h	N/A (Hard-coded)
	EAPD support: 1 = yes, 0 = no.			

Field Name	Bits	R/W	Default	Reset
VrefCntrl	15:8	R	00h	N/A (Hard-coded)
	Vref support: bit 7 = Reserved bit 6 = Reserved bit 5 = 100% support (1 = yes, 0 = no) bit 4 = 80% support (1 = yes, 0 = no) bit 3 = Reserved bit 2 = GND support (1 = yes, 0 = no) bit 1 = 50% support (1 = yes, 0 = no) bit 0 = Hi-Z support (1 = yes, 0 = no)			
Rsvd1	7	R	0h	N/A (Hard-coded)
	Reserved.			
BalancedIO	6	R	1h	N/A (Hard-coded)
	Balanced I/O support: 1 = yes, 0 = no.			
InCap	5	R	0h	N/A (Hard-coded)
	Input support: 1 = yes, 0 = no.			
OutCap	4	R	1h	N/A (Hard-coded)
	Output support: 1 = yes, 0 = no.			
HdphDrvCap	3	R	0h	N/A (Hard-coded)
	Headphone amp present: 1 = yes, 0 = no.			
PresDtctCap	2	R	0h	N/A (Hard-coded)
	Presence detection support: 1 = yes, 0 = no.			
TrigRqd	1	R	0h	N/A (Hard-coded)
	Trigger required for impedance sense: 1 = yes, 0 = no.			
ImpSenseCap	0	R	0h	N/A (Hard-coded)
	Impedance sense support: 1 = yes, 0 = no.			

### 7.8.2. PortD (NID = 0Dh): ConLst

Reg	Byte 4 (Bits 31:24)	Byte 3 (Bits 23:16)	Byte 2 (Bits 15:8)	Byte 1 (Bits 7:0)
Set				
Get	F000Eh			



Field Name	Bits	R/W	Default	Reset
Rsvd	31:8	R	000000h	N/A (Hard-coded)
	Reserved.			
LForm	7	R	0h	N/A (Hard-coded)
	Connection list format: 1 = long-form (15-bit) NID entries, 0 = short-form (7-bit) NID entries.			
ConL	6:0	R	03h	N/A (Hard-coded)
	Number of NID entries in connection list.			

### 7.8.3. PortD (NID = 0Dh): ConLstEntry0

Reg	Byte 4 (Bits 31:24)	Byte 3 (Bits 23:16)	Byte 2 (Bits 15:8)	Byte 1 (Bits 7:0)
Set				
Get	F0200h			

Field Name	Bits	R/W	Default	Reset
ConL3	31:24	R	00h	N/A (Hard-coded)
	Reserved			
ConL2	23:16	R	1Ch	N/A (Hard-coded)
	MixerOutVol Selector widget (0x1C)			
ConL1	15:8	R	14h	N/A (Hard-coded)
	DAC1 Converter widget (0x14)			
ConL0	7:0	R	13h	N/A (Hard-coded)
	DAC0 Converter widget (0x13)			

### 7.8.4. PortD (NID = 0Dh): ConSelectCtrl

Reg	Byte 4 (Bits 31:24)	Byte 3 (Bits 23:16)	Byte 2 (Bits 15:8)	Byte 1 (Bits 7:0)
Set				701h
Get	F0100h			

Field Name	Bits	R/W	Default	Reset
Rsvd	31:2	R	00000000h	N/A (Hard-coded)
	Reserved.			
Index	1:0	RW	0h	POR - DAFG - ULR
	Connection select control index.			

### 7.8.5. PortD (NID = 0Dh): PwrState

Reg	Byte 4 (Bits 31:24)	Byte 3 (Bits 23:16)	Byte 2 (Bits 15:8)	Byte 1 (Bits 7:0)
Set				705h
Get	F0500h			

Field Name	Bits	R/W	Default	Reset
Rsvd4	31:11	R	000000h	N/A (Hard-coded)
	Reserved.			
SettingsReset	10	R	1h	POR - DAFG - ULR
	Indicates if any persistent settings in this Widget have been reset. Cleared by PwrState 'Get', or a 'Set' to any Verb in this Widget.			
Rsvd3	9	R	0h	N/A (Hard-coded)
	Reserved.			
Error	8	R	0h	POR - DAFG - ULR
	Error indicator: 1 = cannot enter requested power state, 0 = no problem with requested power state.			
Rsvd2	7:6	R	0h	N/A (Hard-coded)
	Reserved.			
Act	5:4	R	3h	POR - DAFG - LR
	Actual power state of this widget.			
Rsvd1	3:2	R	0h	N/A (Hard-coded)
	Reserved.			
Set	1:0	RW	0h	POR - DAFG - LR
	Current power state setting for this widget.			

**7.8.6. PortD (NID = 0Dh): PinWCntrl**

Reg	Byte 4 (Bits 31:24)	Byte 3 (Bits 23:16)	Byte 2 (Bits 15:8)	Byte 1 (Bits 7:0)
Set				707h
Get	F0700h			

Field Name	Bits	R/W	Default	Reset
Rsvd2	31:7	R	000000h	N/A (Hard-coded)
	Reserved.			
OutEn	6	RW	0h	POR - DAFG - ULR
	Output enable: 1 = enabled, 0 = disabled.			
Rsvd1	5:0	R	0h	N/A (Hard-coded)
	Reserved.			

**7.8.7. PortD (NID = 0Dh): EAPDBTLLR**

Reg	Byte 4 (Bits 31:24)	Byte 3 (Bits 23:16)	Byte 2 (Bits 15:8)	Byte 1 (Bits 7:0)
Set				70Ch
Get	F0C00h			

Field Name	Bits	R/W	Default	Reset
Rsvd2	31:2	R	00000000h	N/A (Hard-coded)
	Reserved.			
EAPD	1	RW	1h	POR - DAFG - ULR
	EAPD control: 1 = set EAPD pin to 1 (powered) up if this pin is powered up, 0 = set EAPD pin to 0.			
Rsvd1	0	R	0h	N/A (Hard-coded)
	Reserved.			

**7.8.8. PortD (NID = 0Dh): ConfigDefault**

Reg	Byte 4 (Bits 31:24)	Byte 3 (Bits 23:16)	Byte 2 (Bits 15:8)	Byte 1 (Bits 7:0)
Set	71Fh	71Eh	71Dh	71Ch

**7.8.8. PortD (NID = 0Dh): ConfigDefault**

Reg	Byte 4 (Bits 31:24)	Byte 3 (Bits 23:16)	Byte 2 (Bits 15:8)	Byte 1 (Bits 7:0)
Get	F1F00h / F1E00h / F1D00h / F1C00h			

Field Name	Bits	R/W	Default	Reset
PortConnectivity	31:30	RW	2h	POR
Port connectivity: 0h = Port complex is connected to a jack 1h = No physical connection for port 2h = Fixed function device is attached 3h = Both jack and internal device attached (info in all other fields refers to integrated device, any presence detection refers to jack)				
Location	29:24	RW	10h	POR
Location  Bits [5..4]: 0h = External on primary chassis 1h = Internal 2h = Separate chassis 3h = Other  Bits [3..0]: 0h = N/A 1h = Rear 2h = Front 3h = Left 4h = Right 5h = Top 6h = Bottom 7h-9h = Special Ah-Fh = Reserved				

**92HD99****SINGLE CHIP PC AUDIO SYSTEM, CODEC+SPEAKER AMPLIFIER+CAPLESS HP+LDO**

Field Name	Bits	R/W	Default	Reset
Device	23:20	RW	1h	POR
Default device: 0h = Line out 1h = Speaker 2h = HP out 3h = CD 4h = SPDIF Out 5h = Digital other out 6h = Modem line side 7h = Modem handset side 8h = Line in 9h = Aux Ah = Mic in Bh = Telephony Ch = SPDIF In Dh = Digital other in Eh = Reserved Fh = Other				
ConnectionType	19:16	RW	7h	POR
Connection type: 0h = Unknown 1h = 1/8" stereo/mono 2h = 1/4" stereo/mono 3h = ATAPI internal 4h = RCA 5h = Optical 6h = Other digital 7h = Other analog 8h = Multichannel analog (DIN) 9h = XLR/Professional Ah = RJ-11 (modem) Bh = Combination Ch-Eh = Reserved Fh = Other				

**92HD99****SINGLE CHIP PC AUDIO SYSTEM, CODEC+SPEAKER AMPLIFIER+CAPLESS HP+LDO**

Field Name	Bits	R/W	Default	Reset
Color	15:12	RW	0h	POR
	Color: 0h = Unknown 1h = Black 2h = Grey 3h = Blue 4h = Green 5h = Red 6h = Orange 7h = Yellow 8h = Purple 9h = Pink Ah-Dh = Reserved Eh = White Fh = Other			
Misc	11:8	RW	1h	POR
	Miscellaneous: Bits [3..1] = Reserved Bit 0 = Jack detect override			
Association	7:4	RW	1h	POR
	Default association.			
Sequence	3:0	RW	0h	POR
	Sequence.			

## 92HD99

SINGLE CHIP PC AUDIO SYSTEM, CODEC+SPEAKER AMPLIFIER+CAPLESS HP+LDO

---

### 7.9. (NID = 0Eh): Vendor Reserved

## 7.10. PortF (NID = 0Fh): WCap

Reg	Byte 4 (Bits 31:24)	Byte 3 (Bits 23:16)	Byte 2 (Bits 15:8)	Byte 1 (Bits 7:0)
Set				
Get	F0009h			

Field Name	Bits	R/W	Default	Reset
Rsvd2	31:24	R	00h	N/A (Hard-coded)
	Reserved.			
Type	23:20	R	4h	N/A (Hard-coded)
	Widget type: 0h = Out Converter 1h = In Converter 2h = Summing (Mixer) 3h = Selector (Mux) 4h = Pin Complex 5h = Power 6h = Volume Knob 7h = Beep Generator 8h-Eh = Reserved Fh = Vendor Defined			
Delay	19:16	R	0h	N/A (Hard-coded)
	Number of sample delays through widget.			
Rsvd1	15:12	R	0h	N/A (Hard-coded)
	Reserved.			
SwapCap	11	R	0h	N/A (Hard-coded)
	Left/right swap support: 1 = yes, 0 = no.			
PwrCntrl	10	R	1h	N/A (Hard-coded)
	Power state support: 1 = yes, 0 = no.			
Dig	9	R	0h	N/A (Hard-coded)
	Digital stream support: 1 = yes (digital), 0 = no (analog).			
ConnList	8	R	1h	N/A (Hard-coded)
	Connection list present: 1 = yes, 0 = no.			
UnSolCap	7	R	1h	N/A (Hard-coded)
	Unsolicited response support: 1 = yes, 0 = no.			



Field Name	Bits	R/W	Default	Reset
ProcWidget	6	R	0h	N/A (Hard-coded)
	Processing state support: 1 = yes, 0 = no.			
Stripe	5	R	0h	N/A (Hard-coded)
	Striping support: 1 = yes, 0 = no.			
FormatOvr	4	R	0h	N/A (Hard-coded)
	Stream format override: 1 = yes, 0 = no.			
AmpParOvr	3	R	0h	N/A (Hard-coded)
	Amplifier capabilities override: 1 = yes, no.			
OutAmpPrsnt	2	R	0h	N/A (Hard-coded)
	Output amp present: 1 = yes, 0 = no.			
InAmpPrsnt	1	R	1h	N/A (Hard-coded)
	Input amp present: 1 = yes, 0 = no.			
Stereo	0	R	1h	N/A (Hard-coded)
	Stereo stream support: 1 = yes (stereo), 0 = no (mono).			

### 7.10.1. PortF (NID = 0Fh): PinCap

Reg	Byte 4 (Bits 31:24)	Byte 3 (Bits 23:16)	Byte 2 (Bits 15:8)	Byte 1 (Bits 7:0)
Set				
Get	F000Ch			

Field Name	Bits	R/W	Default	Reset
Rsvd2	31:17	R	0000h	N/A (Hard-coded)
	Reserved.			
EapdCap	16	R	1h	N/A (Hard-coded)
	EAPD support: 1 = yes, 0 = no.			

Field Name	Bits	R/W	Default	Reset
VrefCntrl	15:8	R	00h	N/A (Hard-coded)
	Vref support: bit 7 = Reserved bit 6 = Reserved bit 5 = 100% support (1 = yes, 0 = no) bit 4 = 80% support (1 = yes, 0 = no) bit 3 = Reserved bit 2 = GND support (1 = yes, 0 = no) bit 1 = 50% support (1 = yes, 0 = no) bit 0 = Hi-Z support (1 = yes, 0 = no)			
Rsvd1	7	R	0h	N/A (Hard-coded)
	Reserved.			
BalancedIO	6	R	0h	N/A (Hard-coded)
	Balanced I/O support: 1 = yes, 0 = no.			
InCap	5	R	1h	N/A (Hard-coded)
	Input support: 1 = yes, 0 = no.			
OutCap	4	R	0h	N/A (Hard-coded)
	Output support: 1 = yes, 0 = no.			
HdphDrvCap	3	R	0h	N/A (Hard-coded)
	Headphone amp present: 1 = yes, 0 = no.			
PresDtctCap	2	R	1h	N/A (Hard-coded)
	Presence detection support: 1 = yes, 0 = no.			
TrigRqd	1	R	0h	N/A (Hard-coded)
	Trigger required for impedance sense: 1 = yes, 0 = no.			
ImpSenseCap	0	R	0h	N/A (Hard-coded)
	Impedance sense support: 1 = yes, 0 = no.			

### 7.10.2. PortF (NID = 0Fh): ConLst

Reg	Byte 4 (Bits 31:24)	Byte 3 (Bits 23:16)	Byte 2 (Bits 15:8)	Byte 1 (Bits 7:0)
Set				
Get	F000Eh			

Field Name	Bits	R/W	Default	Reset
Rsvd	31:8	R	000000h	N/A (Hard-coded)
	Reserved.			
LForm	7	R	0h	N/A (Hard-coded)
	Connection list format: 1 = long-form (15-bit) NID entries, 0 = short-form (7-bit) NID entries.			
ConL	6:0	R	03h	N/A (Hard-coded)
	Number of NID entries in connection list.			

### 7.10.3. PortF (NID = 0Fh): ConLstEntry0

Reg	Byte 4 (Bits 31:24)	Byte 3 (Bits 23:16)	Byte 2 (Bits 15:8)	Byte 1 (Bits 7:0)
Set				
Get	F0200h			

Field Name	Bits	R/W	Default	Reset
ConL3	31:24	R	00h	N/A (Hard-coded)
	Reserved			
ConL2	23:16	R	1Ch	N/A (Hard-coded)
	MixerOutVol Selector widget (0x1C)			
ConL1	15:8	R	14h	N/A (Hard-coded)
	DAC1 Converter widget (0x14)			
ConL0	7:0	R	13h	N/A (Hard-coded)
	DAC0 Converter widget (0x13)			

### 7.10.4. PortF (NID = 0Fh): InAmpLeft

Reg	Byte 4 (Bits 31:24)	Byte 3 (Bits 23:16)	Byte 2 (Bits 15:8)	Byte 1 (Bits 7:0)
Set				360h
Get	B2000h			

Field Name	Bits	R/W	Default	Reset
Rsvd1	31:2	R	00000000h	N/A (Hard-coded)
	Reserved.			
Gain	1:0	RW	0h	POR - DAFG - ULR
	Amp gain step number (see InAmpCap parameter pertaining to this widget).			

#### 7.10.5. PortF (NID = 0Fh): InAmpRight

Reg	Byte 4 (Bits 31:24)	Byte 3 (Bits 23:16)	Byte 2 (Bits 15:8)	Byte 1 (Bits 7:0)
Set				350h
Get	B0000h			

Field Name	Bits	R/W	Default	Reset
Rsvd1	31:2	R	00000000h	N/A (Hard-coded)
	Reserved.			
Gain	1:0	RW	0h	POR - DAFG - ULR
	Amp gain step number (see InAmpCap parameter pertaining to this widget).			

#### 7.10.6. PortF (NID = 0Fh): ConSelectCtrl

Reg	Byte 4 (Bits 31:24)	Byte 3 (Bits 23:16)	Byte 2 (Bits 15:8)	Byte 1 (Bits 7:0)
Set				701h
Get	F0100h			

Field Name	Bits	R/W	Default	Reset
Rsvd	31:2	R	00000000h	N/A (Hard-coded)
	Reserved.			
Index	1:0	RW	0h	POR - DAFG - ULR
	Connection select control index.			

**7.10.7. PortF (NID = 0Fh): PwrState**

Reg	Byte 4 (Bits 31:24)	Byte 3 (Bits 23:16)	Byte 2 (Bits 15:8)	Byte 1 (Bits 7:0)
Set				705h
Get	F0500h			

Field Name	Bits	R/W	Default	Reset
Rsvd4	31:11	R	000000h	N/A (Hard-coded)
	Reserved.			
SettingsReset	10	R	1h	POR - DAFG - ULR
	Indicates if any persistent settings in this Widget have been reset. Cleared by PwrState 'Get', or a 'Set' to any Verb in this Widget.			
Rsvd3	9	R	0h	N/A (Hard-coded)
	Reserved.			
Error	8	R	0h	POR - DAFG - ULR
	Error indicator: 1 = cannot enter requested power state, 0 = no problem with requested power state.			
Rsvd2	7:6	R	0h	N/A (Hard-coded)
	Reserved.			
Act	5:4	R	3h	POR - DAFG - LR
	Actual power state of this widget.			
Rsvd1	3:2	R	0h	N/A (Hard-coded)
	Reserved.			
Set	1:0	RW	0h	POR - DAFG - LR
	Current power state setting for this widget.			

**7.10.8. PortF (NID = 0Fh): PinWCntrl**

Reg	Byte 4 (Bits 31:24)	Byte 3 (Bits 23:16)	Byte 2 (Bits 15:8)	Byte 1 (Bits 7:0)
Set				707h
Get	F0700h			

Field Name	Bits	R/W	Default	Reset
Rsvd2	31:7	R	000000h	N/A (Hard-coded)
	Reserved.			
OutEn	6	RW	0h	POR - DAFG - ULR
	Output enable: 1 = enabled, 0 = disabled.			
InEn	5	RW	0h	POR - DAFG - ULR
	Input enable: 1 = enabled, 0 = disabled.			
Rsvd1	4:3	R	0h	N/A (Hard-coded)
	Reserved.			
VRefEn	2:0	RW	0h	POR - DAFG - ULR
	Vref selection (See VrefCntrl field of PinCap parameter for supported selections): 000b= HI-Z 001b= 50% 010b= GND 011b= Reserved 100b= 80% 101b= 100% 110b= Reserved 111b= Reserved			

#### 7.10.9. PortF (NID = 0Fh): UnsolResp

Reg	Byte 4 (Bits 31:24)	Byte 3 (Bits 23:16)	Byte 2 (Bits 15:8)	Byte 1 (Bits 7:0)
Set				708h
Get	F0800h			

Field Name	Bits	R/W	Default	Reset
Rsvd2	31:8	R	000000h	N/A (Hard-coded)
	Reserved.			
En	7	RW	0h	POR - DAFG - ULR
	Unsolicited response enable (also enables Wake events for this Widget): 1 = enabled, 0 = disabled.			

Field Name	Bits	R/W	Default	Reset
Rsvd1	6	R	0h	N/A (Hard-coded)
	Reserved.			
Tag	5:0	RW	00h	POR - DAFG - ULR
	Software programmable field returned in top six bits (31:26) of every Unsolicited Response generated by this node.			

**7.10.10. PortF (NID = 0Fh): ChSense**

Reg	Byte 4 (Bits 31:24)	Byte 3 (Bits 23:16)	Byte 2 (Bits 15:8)	Byte 1 (Bits 7:0)
Set				709h
Get	F0900h			

Field Name	Bits	R/W	Default	Reset
PresDtct	31	R	0h	POR
	Presence detection indicator: 1 = presence detected; 0 = presence not detected.			
Rsvd	30:0	R	00000000h	N/A (Hard-coded)
	Reserved.			

**7.10.11. PortF (NID = 0Fh): EAPDBTLR**

Reg	Byte 4 (Bits 31:24)	Byte 3 (Bits 23:16)	Byte 2 (Bits 15:8)	Byte 1 (Bits 7:0)
Set				70Ch
Get	F0C00h			

Field Name	Bits	R/W	Default	Reset
Rsvd2	31:2	R	00000000h	N/A (Hard-coded)
	Reserved.			
EAPD	1	RW	1h	POR - DAFG - ULR
	EAPD control: 1 = set EAPD pin to 1 (powered) up if this pin is powered up, 0 = set EAPD pin to 0.			

Field Name	Bits	R/W	Default	Reset
Rsvd1	0	R	0h	N/A (Hard-coded)
Reserved.				

**7.10.12. PortF (NID = 0Fh): ConfigDefault**

Reg	Byte 4 (Bits 31:24)	Byte 3 (Bits 23:16)	Byte 2 (Bits 15:8)	Byte 1 (Bits 7:0)
Set	71Fh	71Eh	71Dh	71Ch
Get	F1F00h / F1E00h / F1D00h / F1C00h			

Field Name	Bits	R/W	Default	Reset
PortConnectivity	31:30	RW	0h	POR
Port connectivity: 0h = Port complex is connected to a jack 1h = No physical connection for port 2h = Fixed function device is attached 3h = Both jack and internal device attached (info in all other fields refers to integrated device, any presence detection refers to jack)				
Location	29:24	RW	01h	POR
Location  Bits [5..4]: 0h = External on primary chassis 1h = Internal 2h = Separate chassis 3h = Other  Bits [3..0]: 0h = N/A 1h = Rear 2h = Front 3h = Left 4h = Right 5h = Top 6h = Bottom 7h-9h = Special Ah-Fh = Reserved				



**92HD99****SINGLE CHIP PC AUDIO SYSTEM, CODEC+SPEAKER AMPLIFIER+CAPLESS HP+LDO**

Field Name	Bits	R/W	Default	Reset
Device	23:20	RW	8h	POR
Default device: 0h = Line out 1h = Speaker 2h = HP out 3h = CD 4h = SPDIF Out 5h = Digital other out 6h = Modem line side 7h = Modem handset side 8h = Line in 9h = Aux Ah = Mic in Bh = Telephony Ch = SPDIF In Dh = Digital other in Eh = Reserved Fh = Other				
ConnectionType	19:16	RW	1h	POR
Connection type: 0h = Unknown 1h = 1/8" stereo/mono 2h = 1/4" stereo/mono 3h = ATAPI internal 4h = RCA 5h = Optical 6h = Other digital 7h = Other analog 8h = Multichannel analog (DIN) 9h = XLR/Professional Ah = RJ-11 (modem) Bh = Combination Ch-Eh = Reserved Fh = Other				

**92HD99****SINGLE CHIP PC AUDIO SYSTEM, CODEC+SPEAKER AMPLIFIER+CAPLESS HP+LDO**

Field Name	Bits	R/W	Default	Reset
Color	15:12	RW	3h	POR
	Color: 0h = Unknown 1h = Black 2h = Grey 3h = Blue 4h = Green 5h = Red 6h = Orange 7h = Yellow 8h = Purple 9h = Pink Ah-Dh = Reserved Eh = White Fh = Other			
Misc	11:8	RW	0h	POR
	Miscellaneous: Bits [3..1] = Reserved Bit 0 = Jack detect override			
Association	7:4	RW	2h	POR
	Default association.			
Sequence	3:0	RW	Eh	POR
	Sequence.			

**7.11. (NID = 10h): Vendor Reserved**

## 7.12. DMic0 (NID = 11h): WCap

Reg	Byte 4 (Bits 31:24)	Byte 3 (Bits 23:16)	Byte 2 (Bits 15:8)	Byte 1 (Bits 7:0)
Set				
Get	F0009h			

Field Name	Bits	R/W	Default	Reset
Rsvd2	31:24	R	00h	N/A (Hard-coded)
	Reserved.			
Type	23:20	R	4h	N/A (Hard-coded)
	Widget type: 0h = Out Converter 1h = In Converter 2h = Summing (Mixer) 3h = Selector (Mux) 4h = Pin Complex 5h = Power 6h = Volume Knob 7h = Beep Generator 8h-Eh = Reserved Fh = Vendor Defined			
Delay	19:16	R	0h	N/A (Hard-coded)
	Number of sample delays through widget.			
Rsvd1	15:12	R	0h	N/A (Hard-coded)
	Reserved.			
SwapCap	11	R	0h	N/A (Hard-coded)
	Left/right swap support: 1 = yes, 0 = no.			
PwrCntrl	10	R	1h	N/A (Hard-coded)
	Power state support: 1 = yes, 0 = no.			
DigitalStrm	9	R	0h	N/A (Hard-coded)
	Digital stream support: 1 = yes (digital), 0 = no (analog).			
ConnList	8	R	0h	N/A (Hard-coded)
	Connection list present: 1 = yes, 0 = no.			
UnsolCap	7	R	1h	N/A (Hard-coded)
	Unsolicited response support: 1 = yes, 0 = no.			

Field Name	Bits	R/W	Default	Reset
ProcWidget	6	R	0h	N/A (Hard-coded)
	Processing state support: 1 = yes, 0 = no.			
Stripe	5	R	0h	N/A (Hard-coded)
	Striping support: 1 = yes, 0 = no.			
FormatOvr	4	R	0h	N/A (Hard-coded)
	Stream format override: 1 = yes, 0 = no.			
AmpParOvr	3	R	0h	N/A (Hard-coded)
	Amplifier capabilities override: 1 = yes, no.			
OutAmpPrsnt	2	R	0h	N/A (Hard-coded)
	Output amp present: 1 = yes, 0 = no.			
InAmpPrsnt	1	R	1h	N/A (Hard-coded)
	Input amp present: 1 = yes, 0 = no.			
Stereo	0	R	1h	N/A (Hard-coded)
	Stereo stream support: 1 = yes (stereo), 0 = no (mono).			

### 7.12.1. DMic0 (NID = 11h): PinCap

Reg	Byte 4 (Bits 31:24)	Byte 3 (Bits 23:16)	Byte 2 (Bits 15:8)	Byte 1 (Bits 7:0)
Set				
Get	F000Ch			

Field Name	Bits	R/W	Default	Reset
Rsvd2	31:17	R	0000h	N/A (Hard-coded)
	Reserved.			
EapdCap	16	R	0h	N/A (Hard-coded)
	EAPD support: 1 = yes, 0 = no.			

# 92HD99

## SINGLE CHIP PC AUDIO SYSTEM, CODEC+SPEAKER AMPLIFIER+CAPLESS HP+LDO

Field Name	Bits	R/W	Default	Reset
VRefCntrl	15:8	R	00h	N/A (Hard-coded)
	Vref support: bit 7 = Reserved bit 6 = Reserved bit 5 = 100% support (1 = yes, 0 = no) bit 4 = 80% support (1 = yes, 0 = no) bit 3 = Reserved bit 2 = GND support (1 = yes, 0 = no) bit 1 = 50% support (1 = yes, 0 = no) bit 0 = Hi-Z support (1 = yes, 0 = no)			
Rsvd1	7	R	0h	N/A (Hard-coded)
	Reserved.			
BalancedIO	6	R	0h	N/A (Hard-coded)
	Balanced I/O support: 1 = yes, 0 = no.			
InCap	5	R	1h	N/A (Hard-coded)
	Input support: 1 = yes, 0 = no.			
OutCap	4	R	0h	N/A (Hard-coded)
	Output support: 1 = yes, 0 = no.			
HPhnDrvCap	3	R	0h	N/A (Hard-coded)
	Headphone amp present: 1 = yes, 0 = no.			
PresDtctCap	2	R	1h	N/A (Hard-coded)
	Presence detection support: 1 = yes, 0 = no.			
TrigRqd	1	R	0h	N/A (Hard-coded)
	Trigger required for impedance sense: 1 = yes, 0 = no.			
ImpSenseCap	0	R	0h	N/A (Hard-coded)
	Impedance sense support: 1 = yes, 0 = no.			

### 7.12.2. DMic0 (NID = 11h): InAmpLeft

Reg	Byte 4 (Bits 31:24)	Byte 3 (Bits 23:16)	Byte 2 (Bits 15:8)	Byte 1 (Bits 7:0)
Set				360h
Get	B2000h			

Field Name	Bits	R/W	Default	Reset
Rsvd1	31:2	R	00000000h	N/A (Hard-coded)
	Reserved.			
Gain	1:0	RW	0h	POR - DAFG - ULR
	Amp gain step number (see InAmpCap parameter pertaining to this widget).			

### 7.12.3. DMic0 (NID = 11h): InAmpRight

Reg	Byte 4 (Bits 31:24)	Byte 3 (Bits 23:16)	Byte 2 (Bits 15:8)	Byte 1 (Bits 7:0)
Set				350h
Get	B0000h			

Field Name	Bits	R/W	Default	Reset
Rsvd1	31:2	R	00000000h	N/A (Hard-coded)
	Reserved.			
Gain	1:0	RW	0h	POR - DAFG - ULR
	Amp gain step number (see InAmpCap parameter pertaining to this widget).			

### 7.12.4. DMic0 (NID = 11h): PwrState

Reg	Byte 4 (Bits 31:24)	Byte 3 (Bits 23:16)	Byte 2 (Bits 15:8)	Byte 1 (Bits 7:0)
Set				705h
Get	F0500h			

Field Name	Bits	R/W	Default	Reset
Rsvd4	31:11	R	000000h	N/A (Hard-coded)
	Reserved.			
SettingsReset	10	R	1h	POR - DAFG - ULR
	Indicates if any persistent settings in this Widget have been reset. Cleared by PwrState 'Get', or a 'Set' to any Verb in this Widget.			

Field Name	Bits	R/W	Default	Reset
Rsvd3	9	R	0h	N/A (Hard-coded)
	Reserved.			
Error	8	R	0h	POR - DAFG - ULR
	Error indicator: 1 = cannot enter requested power state, 0 = no problem with requested power state.			
Rsvd2	7:6	R	0h	N/A (Hard-coded)
	Reserved.			
Act	5:4	R	3h	POR - DAFG - LR
	Actual power state of this widget.			
Rsvd1	3:2	R	0h	N/A (Hard-coded)
	Reserved.			
Set	1:0	RW	0h	POR - DAFG - LR
	Current power state setting for this widget.			

#### 7.12.5. DMic0 (NID = 11h): PinWCntrl

Reg	Byte 4 (Bits 31:24)	Byte 3 (Bits 23:16)	Byte 2 (Bits 15:8)	Byte 1 (Bits 7:0)
Set				707h
Get	F0700h			

Field Name	Bits	R/W	Default	Reset
Rsvd2	31:6	R	0000000h	N/A (Hard-coded)
	Reserved.			
InEn	5	RW	0h	POR - DAFG - ULR
	Input enable: 1 = enabled, 0 = disabled.			
Rsvd1	4:0	R	00h	N/A (Hard-coded)
	Reserved.			



**7.12.6. DMic0 (NID = 11h): UnsolResp**

Reg	Byte 4 (Bits 31:24)	Byte 3 (Bits 23:16)	Byte 2 (Bits 15:8)	Byte 1 (Bits 7:0)
Set				708h
Get	F0800h			

Field Name	Bits	R/W	Default	Reset
Rsvd2	31:8	R	000000h	N/A (Hard-coded)
	Reserved.			
En	7	RW	0h	POR - DAFG - ULR
	Unsolicited response enable (also enables Wake events for this Widget): 1 = enabled, 0 = disabled.			
Rsvd1	6	R	0h	N/A (Hard-coded)
	Reserved.			
Tag	5:0	RW	00h	POR - DAFG - ULR
	Software programmable field returned in top six bits (31:26) of every Unsolicited Response generated by this node.			

**7.12.7. DMic0 (NID = 11h): ChSense**

Reg	Byte 4 (Bits 31:24)	Byte 3 (Bits 23:16)	Byte 2 (Bits 15:8)	Byte 1 (Bits 7:0)
Set				709h
Get	F0900h			

Field Name	Bits	R/W	Default	Reset
PresDtct	31	R	0h	POR
	Presence detection indicator: 1 = presence detected; 0 = presence not detected.			
Rsvd	30:0	R	00000000h	N/A (Hard-coded)
	Reserved.			

**7.12.8. DMic0 (NID = 11h): ConfigDefault**

Reg	Byte 4 (Bits 31:24)	Byte 3 (Bits 23:16)	Byte 2 (Bits 15:8)	Byte 1 (Bits 7:0)
Set	71Fh	71Eh	71Dh	71Ch
Get	F1F00h / F1E00h / F1D00h / F1C00h			

Field Name	Bits	R/W	Default	Reset
PortConnectivity	31:30	RW	2h	POR
Port connectivity: 0h = Port complex is connected to a jack 1h = No physical connection for port 2h = Fixed function device is attached 3h = Both jack and internal device attached (info in all other fields refers to integrated device, any presence detection refers to jack)				
Location	29:24	RW	10h	POR
Location  Bits [5..4]: 0h = External on primary chassis 1h = Internal 2h = Separate chassis 3h = Other  Bits [3..0]: 0h = N/A 1h = Rear 2h = Front 3h = Left 4h = Right 5h = Top 6h = Bottom 7h-9h = Special Ah-Fh = Reserved				

**92HD99****SINGLE CHIP PC AUDIO SYSTEM, CODEC+SPEAKER AMPLIFIER+CAPLESS HP+LDO**

Field Name	Bits	R/W	Default	Reset
Device	23:20	RW	Ah	POR
Default device: 0h = Line out 1h = Speaker 2h = HP out 3h = CD 4h = SPDIF Out 5h = Digital other out 6h = Modem line side 7h = Modem handset side 8h = Line in 9h = Aux Ah = Mic in Bh = Telephony Ch = SPDIF In Dh = Digital other in Eh = Reserved Fh = Other				
ConnectionType	19:16	RW	3h	POR
Connection type: 0h = Unknown 1h = 1/8" stereo/mono 2h = 1/4" stereo/mono 3h = ATAPI internal 4h = RCA 5h = Optical 6h = Other digital 7h = Other analog 8h = Multichannel analog (DIN) 9h = XLR/Professional Ah = RJ-11 (modem) Bh = Combination Ch-Eh = Reserved Fh = Other				

**92HD99****SINGLE CHIP PC AUDIO SYSTEM, CODEC+SPEAKER AMPLIFIER+CAPLESS HP+LDO**

Field Name	Bits	R/W	Default	Reset
Color	15:12	RW	0h	POR
	Color: 0h = Unknown 1h = Black 2h = Grey 3h = Blue 4h = Green 5h = Red 6h = Orange 7h = Yellow 8h = Purple 9h = Pink Ah-Dh = Reserved Eh = White Fh = Other			
Misc	11:8	RW	1h	POR
	Miscellaneous: Bits [3..1] = Reserved Bit 0 = Jack detect override			
Association	7:4	RW	3h	POR
	Default association.			
Sequence	3:0	RW	0h	POR
	Sequence.			

**7.13. (NID = 12h): Vendor Reserved**

## 7.14. DAC0 (NID = 13h): WCap

Reg	Byte 4 (Bits 31:24)	Byte 3 (Bits 23:16)	Byte 2 (Bits 15:8)	Byte 1 (Bits 7:0)
Set				
Get	F0009h			

Field Name	Bits	R/W	Default	Reset
Rsvd2	31:24	R	00h	N/A (Hard-coded)
	Reserved.			
Type	23:20	R	0h	N/A (Hard-coded)
	Widget type: 0h = Out Converter 1h = In Converter 2h = Summing (Mixer) 3h = Selector (Mux) 4h = Pin Complex 5h = Power 6h = Volume Knob 7h = Beep Generator 8h-Eh = Reserved Fh = Vendor Defined			
Delay	19:16	R	Dh	N/A (Hard-coded)
	Number of sample delays through widget.			
Rsvd1	15:12	R	0h	N/A (Hard-coded)
	Reserved.			
SwapCap	11	R	1h	N/A (Hard-coded)
	Left/right swap support: 1 = yes, 0 = no.			
PwrCntrl	10	R	1h	N/A (Hard-coded)
	Power state support: 1 = yes, 0 = no.			
Dig	9	R	0h	N/A (Hard-coded)
	Digital stream support: 1 = yes (digital), 0 = no (analog).			
ConnList	8	R	0h	N/A (Hard-coded)
	Connection list present: 1 = yes, 0 = no.			
UnSolCap	7	R	0h	N/A (Hard-coded)
	Unsolicited response support: 1 = yes, 0 = no.			

Field Name	Bits	R/W	Default	Reset
ProcWidget	6	R	0h	N/A (Hard-coded)
	Processing state support: 1 = yes, 0 = no.			
Stripe	5	R	0h	N/A (Hard-coded)
	Striping support: 1 = yes, 0 = no.			
FormatOvr	4	R	0h	N/A (Hard-coded)
	Stream format override: 1 = yes, 0 = no.			
AmpParOvr	3	R	0h	N/A (Hard-coded)
	Amplifier capabilities override: 1 = yes, no.			
OutAmpPrsnt	2	R	1h	N/A (Hard-coded)
	Output amp present: 1 = yes, 0 = no.			
InAmpPrsnt	1	R	0h	N/A (Hard-coded)
	Input amp present: 1 = yes, 0 = no.			
Stereo	0	R	1h	N/A (Hard-coded)
	Stereo stream support: 1 = yes (stereo), 0 = no (mono).			

#### 7.14.1. DAC0 (NID = 13h): Cnvtr

Reg	Byte 4 (Bits 31:24)	Byte 3 (Bits 23:16)	Byte 2 (Bits 15:8)	Byte 1 (Bits 7:0)
Set				2h
Get	A0000h			

Field Name	Bits	R/W	Default	Reset
Rsvd2	31:16	R	0000h	N/A (Hard-coded)
	Reserved.			
StrmType	15	R	0h	N/A (Hard-coded)
	Stream type: 1 = Non-PCM, 0 = PCM.			
FrmtSmpIRate	14	RW	0h	POR - DAFG - ULR
	Sample base rate: 1 = 44.1kHz, 0 = 48kHz.			

Field Name	Bits	R/W	Default	Reset
SmplRateMultp	13:11	RW	0h	POR - DAFG - ULR
	Sample base rate multiple: 000b= x1 (48kHz/44.1kHz or less) 001b= x2 (96kHz/88.2kHz/32kHz) 010b= x3 (144kHz) 011b= x4 (192kHz/176.4kHz) 100b-111b Reserved			
SmplRateDiv	10:8	RW	0h	POR - DAFG - ULR
	Sample base rate divider: 000b= Divide by 1 (48kHz/44.1kHz) 001b= Divide by 2 (24kHz/20.05kHz) 010b= Divide by 3 (16kHz/32kHz) 011b= Divide by 4 (11.025kHz) 100b= Divide by 5 (9.6kHz) 101b= Divide by 6 (8kHz) 110b= Divide by 7 111b= Divide by 8 (6kHz)			
Rsvd1	7	R	0h	N/A (Hard-coded)
	Reserved.			
BitsPerSmpl	6:4	RW	3h	POR - DAFG - ULR
	Bits per sample: 000b= 8 bits 001b= 16 bits 010b= 20 bits 011b= 24 bits 100b= 32 bits 101b-111b= Reserved			
NmbrChan	3:0	RW	1h	POR - DAFG - ULR
	Total number of channels in the stream assigned to this converter: 0000b-1111b= 1-16 channels.			

#### 7.14.2. DAC0 (NID = 13h): OutAmpLeft

Reg	Byte 4 (Bits 31:24)	Byte 3 (Bits 23:16)	Byte 2 (Bits 15:8)	Byte 1 (Bits 7:0)
Set				3A0h
Get	BA000h			



Field Name	Bits	R/W	Default	Reset
Rsvd	31:8	R	000000h	N/A (Hard-coded)
	Reserved.			
Mute	7	RW	1h	POR - DAFG - ULR
	Amp mute: 1 = muted, 0 = not muted.			
Gain	6:0	RW	7Fh	POR - DAFG - ULR
	Amp gain step number (see OutAmpCap parameter pertaining to this widget).			

#### 7.14.3. DAC0 (NID = 13h): OutAmpRight

Reg	Byte 4 (Bits 31:24)	Byte 3 (Bits 23:16)	Byte 2 (Bits 15:8)	Byte 1 (Bits 7:0)
Set				390h
Get	B8000h			

Field Name	Bits	R/W	Default	Reset
Rsvd	31:8	R	000000h	N/A (Hard-coded)
	Reserved.			
Mute	7	RW	1h	POR - DAFG - ULR
	Amp mute: 1 = muted, 0 = not muted.			
Gain	6:0	RW	7Fh	POR - DAFG - ULR
	Amp gain step number (see OutAmpCap parameter pertaining to this widget).			

#### 7.14.4. DAC0 (NID = 13h): PwrState

Reg	Byte 4 (Bits 31:24)	Byte 3 (Bits 23:16)	Byte 2 (Bits 15:8)	Byte 1 (Bits 7:0)
Set				705h
Get	F0500h			

Field Name	Bits	R/W	Default	Reset
Rsvd4	31:11	R	000000h	N/A (Hard-coded)
	Reserved.			

## 92HD99

### SINGLE CHIP PC AUDIO SYSTEM, CODEC+SPEAKER AMPLIFIER+CAPLESS HP+LDO

Field Name	Bits	R/W	Default	Reset
SettingsReset	10	R	1h	POR - DAFG - ULR
	Indicates if any persistent settings in this Widget have been reset. Cleared by PwrState 'Get', or a 'Set' to any Verb in this Widget.			
Rsvd3	9	R	0h	N/A (Hard-coded)
	Reserved.			
Error	8	R	0h	POR - DAFG - ULR
	Error indicator: 1 = cannot enter requested power state, 0 = no problem with requested power state.			
Rsvd2	7:6	R	0h	N/A (Hard-coded)
	Reserved.			
Act	5:4	R	3h	POR - DAFG - LR
	Actual power state of this widget.			
Rsvd1	3:2	R	0h	N/A (Hard-coded)
	Reserved.			
Set	1:0	RW	3h	POR - DAFG - LR
	Current power state setting for this widget.			

#### 7.14.5. DAC0 (NID = 13h): CnvtrID

Reg	Byte 4 (Bits 31:24)	Byte 3 (Bits 23:16)	Byte 2 (Bits 15:8)	Byte 1 (Bits 7:0)
Set				706h
Get	F0600h			

Field Name	Bits	R/W	Default	Reset
Rsvd	31:8	R	000000h	N/A (Hard-coded)
	Reserved.			
Strm	7:4	RW	0h	POR - S&DAFG - LR - PS
	Stream ID: 0h = Converter "off", 1h-Fh = valid ID's.			
Ch	3:0	RW	0h	POR - S&DAFG - LR - PS
	Channel assignment ("Ch" and "Ch+1" assigned as a pair, for a stereo converter).			

**7.14.6. DAC0 (NID = 13h): EAPDBTLR**

Reg	Byte 4 (Bits 31:24)	Byte 3 (Bits 23:16)	Byte 2 (Bits 15:8)	Byte 1 (Bits 7:0)
Set				70Ch
Get	F0C00h			

Field Name	Bits	R/W	Default	Reset
Rsvd2	31:3	R	00000000h	N/A (Hard-coded)
	Reserved.			
SwapEn	2	RW	0h	POR - DAFG - ULR
	Swap enable: 1 = L/R swap enabled, 0 = L/R swap disabled.			
Rsvd1	1:0	R	0h	N/A (Hard-coded)
	Reserved.			

**7.15. DAC1 (NID = 14h): WCap**

Reg	Byte 4 (Bits 31:24)	Byte 3 (Bits 23:16)	Byte 2 (Bits 15:8)	Byte 1 (Bits 7:0)
Set				
Get	F0009h			

Field Name	Bits	R/W	Default	Reset
Rsvd2	31:24	R	00h	N/A (Hard-coded)
	Reserved.			
Type	23:20	R	0h	N/A (Hard-coded)
Widget type: 0h = Out Converter 1h = In Converter 2h = Summing (Mixer) 3h = Selector (Mux) 4h = Pin Complex 5h = Power 6h = Volume Knob 7h = Beep Generator 8h-Eh = Reserved Fh = Vendor Defined				

# 92HD99

## SINGLE CHIP PC AUDIO SYSTEM, CODEC+SPEAKER AMPLIFIER+CAPLESS HP+LDO

Field Name	Bits	R/W	Default	Reset
Delay	19:16	R	Dh	N/A (Hard-coded)
	Number of sample delays through widget.			
Rsvd1	15:12	R	0h	N/A (Hard-coded)
	Reserved.			
SwapCap	11	R	1h	N/A (Hard-coded)
	Left/right swap support: 1 = yes, 0 = no.			
PwrCntrl	10	R	1h	N/A (Hard-coded)
	Power state support: 1 = yes, 0 = no.			
Dig	9	R	0h	N/A (Hard-coded)
	Digital stream support: 1 = yes (digital), 0 = no (analog).			
ConnList	8	R	0h	N/A (Hard-coded)
	Connection list present: 1 = yes, 0 = no.			
UnSolCap	7	R	0h	N/A (Hard-coded)
	Unsolicited response support: 1 = yes, 0 = no.			
ProcWidget	6	R	0h	N/A (Hard-coded)
	Processing state support: 1 = yes, 0 = no.			
Stripe	5	R	0h	N/A (Hard-coded)
	Striping support: 1 = yes, 0 = no.			
FormatOvrd	4	R	0h	N/A (Hard-coded)
	Stream format override: 1 = yes, 0 = no.			
AmpParOvrd	3	R	0h	N/A (Hard-coded)
	Amplifier capabilities override: 1 = yes, no.			
OutAmpPrsnt	2	R	1h	N/A (Hard-coded)
	Output amp present: 1 = yes, 0 = no.			
InAmpPrsnt	1	R	0h	N/A (Hard-coded)
	Input amp present: 1 = yes, 0 = no.			
Stereo	0	R	1h	N/A (Hard-coded)
	Stereo stream support: 1 = yes (stereo), 0 = no (mono).			

**7.15.1. DAC1 (NID = 14h): Cnvtr**

Reg	Byte 4 (Bits 31:24)	Byte 3 (Bits 23:16)	Byte 2 (Bits 15:8)	Byte 1 (Bits 7:0)
Set				2h
Get	A0000h			

Field Name	Bits	R/W	Default	Reset
Rsvd2	31:16	R	0000h	N/A (Hard-coded)
	Reserved.			
StrmType	15	R	0h	N/A (Hard-coded)
	Stream type: 1 = Non-PCM, 0 = PCM.			
FrmtSmplRate	14	RW	0h	POR - DAFG - ULR
	Sample base rate: 1 = 44.1kHz, 0 = 48kHz.			
SmplRateMltp	13:11	RW	0h	POR - DAFG - ULR
	Sample base rate multiple: 000b= x1 (48kHz/44.1kHz or less) 001b= x2 (96kHz/88.2kHz/32kHz) 010b= x3 (144kHz) 011b= x4 (192kHz/176.4kHz) 100b-111b Reserved			
SmplRateDiv	10:8	RW	0h	POR - DAFG - ULR
	Sample base rate divider: 000b= Divide by 1 (48kHz/44.1kHz) 001b= Divide by 2 (24kHz/20.05kHz) 010b= Divide by 3 (16kHz/32kHz) 011b= Divide by 4 (11.025kHz) 100b= Divide by 5 (9.6kHz) 101b= Divide by 6 (8kHz) 110b= Divide by 7 111b= Divide by 8 (6kHz)			
Rsvd1	7	R	0h	N/A (Hard-coded)
	Reserved.			

Field Name	Bits	R/W	Default	Reset
BitsPerSmpl	6:4	RW	3h	POR - DAFG - ULR
	Bits per sample: 000b= 8 bits 001b= 16 bits 010b= 20 bits 011b= 24 bits 100b= 32 bits 101b-111b= Reserved			
NmbrChan	3:0	RW	1h	POR - DAFG - ULR
	Total number of channels in the stream assigned to this converter: 0000b-1111b= 1-16 channels.			

### 7.15.2. DAC1 (NID = 14h): OutAmpLeft

Reg	Byte 4 (Bits 31:24)	Byte 3 (Bits 23:16)	Byte 2 (Bits 15:8)	Byte 1 (Bits 7:0)
Set				3A0h
Get	BA000h			

Field Name	Bits	R/W	Default	Reset
Rsvd	31:8	R	000000h	N/A (Hard-coded)
	Reserved.			
Mute	7	RW	1h	POR - DAFG - ULR
	Amp mute: 1 = muted, 0 = not muted.			
Gain	6:0	RW	7Fh	POR - DAFG - ULR
	Amp gain step number (see OutAmpCap parameter pertaining to this widget).			

### 7.15.3. DAC1 (NID = 14h): OutAmpRight

Reg	Byte 4 (Bits 31:24)	Byte 3 (Bits 23:16)	Byte 2 (Bits 15:8)	Byte 1 (Bits 7:0)
Set				390h
Get	B8000h			

## 92HD99

### SINGLE CHIP PC AUDIO SYSTEM, CODEC+SPEAKER AMPLIFIER+CAPLESS HP+LDO

Field Name	Bits	R/W	Default	Reset
Rsvd	31:8	R	000000h	N/A (Hard-coded)
	Reserved.			
Mute	7	RW	1h	POR - DAFG - ULR
	Amp mute: 1 = muted, 0 = not muted.			
Gain	6:0	RW	7Fh	POR - DAFG - ULR
	Amp gain step number (see OutAmpCap parameter pertaining to this widget).			

#### 7.15.4. DAC1 (NID = 14h): PwrState

Reg	Byte 4 (Bits 31:24)	Byte 3 (Bits 23:16)	Byte 2 (Bits 15:8)	Byte 1 (Bits 7:0)
Set				705h
Get	F0500h			

Field Name	Bits	R/W	Default	Reset
Rsvd4	31:11	R	000000h	N/A (Hard-coded)
	Reserved.			
SettingsReset	10	R	1h	POR - DAFG - ULR
	Indicates if any persistent settings in this Widget have been reset. Cleared by PwrState 'Get', or a 'Set' to any Verb in this Widget.			
Rsvd3	9	R	0h	N/A (Hard-coded)
	Reserved.			
Error	8	R	0h	POR - DAFG - ULR
	Error indicator: 1 = cannot enter requested power state, 0 = no problem with requested power state.			
Rsvd2	7:6	R	0h	N/A (Hard-coded)
	Reserved.			
Act	5:4	R	3h	POR - DAFG - LR
	Actual power state of this widget.			
Rsvd1	3:2	R	0h	N/A (Hard-coded)
	Reserved.			

Field Name	Bits	R/W	Default	Reset
Set	1:0	RW	3h	POR - DAFG - LR
Current power state setting for this widget.				

#### 7.15.5. DAC1 (NID = 14h): CnvtrID

Reg	Byte 4 (Bits 31:24)	Byte 3 (Bits 23:16)	Byte 2 (Bits 15:8)	Byte 1 (Bits 7:0)
Set				706h
Get	F0600h			

Field Name	Bits	R/W	Default	Reset
Rsvd	31:8	R	000000h	N/A (Hard-coded)
Reserved.				
Strm	7:4	RW	0h	POR - S&DAFG - LR - PS
Stream ID: 0h = Converter "off", 1h-Fh = valid ID's.				
Ch	3:0	RW	0h	POR - S&DAFG - LR - PS
Channel assignment ("Ch" and "Ch+1" assigned as a pair, for a stereo converter).				

#### 7.15.6. DAC1 (NID = 14h): EAPDBTLLR

Reg	Byte 4 (Bits 31:24)	Byte 3 (Bits 23:16)	Byte 2 (Bits 15:8)	Byte 1 (Bits 7:0)
Set				70Ch
Get	F0C00h			

Field Name	Bits	R/W	Default	Reset
Rsvd2	31:3	R	00000000h	N/A (Hard-coded)
Reserved.				
SwapEn	2	RW	0h	POR - DAFG - ULR
Swap enable: 1 = L/R swap enabled, 0 = L/R swap disabled.				
Rsvd1	1:0	R	0h	N/A (Hard-coded)
Reserved.				



## 7.16. ADC0 (NID = 15h): WCap

Reg	Byte 4 (Bits 31:24)	Byte 3 (Bits 23:16)	Byte 2 (Bits 15:8)	Byte 1 (Bits 7:0)
Set				
Get	F0009h			

Field Name	Bits	R/W	Default	Reset
Rsvd2	31:24	R	00h	N/A (Hard-coded)
	Reserved.			
Type	23:20	R	1h	N/A (Hard-coded)
	Widget type: 0h = Out Converter 1h = In Converter 2h = Summing (Mixer) 3h = Selector (Mux) 4h = Pin Complex 5h = Power 6h = Volume Knob 7h = Beep Generator 8h-Eh = Reserved Fh = Vendor Defined			
Delay	19:16	R	Dh	N/A (Hard-coded)
	Number of sample delays through widget.			
Rsvd1	15:12	R	0h	N/A (Hard-coded)
	Reserved.			
SwapCap	11	R	0h	N/A (Hard-coded)
	Left/right swap support: 1 = yes, 0 = no.			
PwrCntrl	10	R	1h	N/A (Hard-coded)
	Power state support: 1 = yes, 0 = no.			
Dig	9	R	0h	N/A (Hard-coded)
	Digital stream support: 1 = yes (digital), 0 = no (analog).			
ConnList	8	R	1h	N/A (Hard-coded)
	Connection list present: 1 = yes, 0 = no.			
UnSolCap	7	R	0h	N/A (Hard-coded)
	Unsolicited response support: 1 = yes, 0 = no.			

Field Name	Bits	R/W	Default	Reset
ProcWidget	6	R	1h	N/A (Hard-coded)
	Processing state support: 1 = yes, 0 = no.			
Stripe	5	R	0h	N/A (Hard-coded)
	Striping support: 1 = yes, 0 = no.			
FormatOvr	4	R	0h	N/A (Hard-coded)
	Stream format override: 1 = yes, 0 = no.			
AmpParOvr	3	R	0h	N/A (Hard-coded)
	Amplifier capabilities override: 1 = yes, no.			
OutAmpPrsnt	2	R	0h	N/A (Hard-coded)
	Output amp present: 1 = yes, 0 = no.			
InAmpPrsnt	1	R	0h	N/A (Hard-coded)
	Input amp present: 1 = yes, 0 = no.			
Stereo	0	R	1h	N/A (Hard-coded)
	Stereo stream support: 1 = yes (stereo), 0 = no (mono).			

### 7.16.1. ADC0 (NID = 15h): ConLst

Reg	Byte 4 (Bits 31:24)	Byte 3 (Bits 23:16)	Byte 2 (Bits 15:8)	Byte 1 (Bits 7:0)
Set				
Get	F000Eh			

Field Name	Bits	R/W	Default	Reset
Rsvd	31:8	R	000000h	N/A (Hard-coded)
	Reserved.			
LForm	7	R	0h	N/A (Hard-coded)
	Connection list format: 1 = long-form (15-bit) NID entries, 0 = short-form (7-bit) NID entries.			
ConL	6:0	R	01h	N/A (Hard-coded)
	Number of NID entries in connection list.			

## 7.16.2. ADC0 (NID = 15h): ConLstEntry0

Reg	Byte 4 (Bits 31:24)	Byte 3 (Bits 23:16)	Byte 2 (Bits 15:8)	Byte 1 (Bits 7:0)
Set				
Get	F0200h			

Field Name	Bits	R/W	Default	Reset
ConL3	31:24	R	00h	N/A (Hard-coded)
	Unused list entry.			
ConL2	23:16	R	00h	N/A (Hard-coded)
	Unused list entry.			
ConL1	15:8	R	00h	N/A (Hard-coded)
	Unused list entry.			
ConL0	7:0	R	20h	N/A (Hard-coded)
	ADC0Mux Selector widget (0x17)			

## 7.16.3. ADC0 (NID = 15h): Cnvtr

Reg	Byte 4 (Bits 31:24)	Byte 3 (Bits 23:16)	Byte 2 (Bits 15:8)	Byte 1 (Bits 7:0)
Set				2h
Get	A0000h			

Field Name	Bits	R/W	Default	Reset
Rsvd2	31:16	R	0000h	N/A (Hard-coded)
	Reserved.			
StrmType	15	R	0h	N/A (Hard-coded)
	Stream type: 1 = Non-PCM, 0 = PCM.			
FrmtSmplRate	14	RW	0h	POR - DAFG - ULR
	Sample base rate: 1 = 44.1kHz, 0 = 48kHz.			

Field Name	Bits	R/W	Default	Reset
SmplRateMultp	13:11	RW	0h	POR - DAFG - ULR
	Sample base rate multiple: 000b= x1 (48kHz/44.1kHz or less) 001b= x2 (96kHz/88.2kHz/32kHz) 010b= x3 (144kHz) 011b= x4 (192kHz/176.4kHz) 100b-111b Reserved			
SmplRateDiv	10:8	RW	0h	POR - DAFG - ULR
	Sample base rate divider: 000b= Divide by 1 (48kHz/44.1kHz) 001b= Divide by 2 (24kHz/20.05kHz) 010b= Divide by 3 (16kHz/32kHz) 011b= Divide by 4 (11.025kHz) 100b= Divide by 5 (9.6kHz) 101b= Divide by 6 (8kHz) 110b= Divide by 7 111b= Divide by 8 (6kHz)			
Rsvd1	7	R	0h	N/A (Hard-coded)
	Reserved.			
BitsPerSmpl	6:4	RW	3h	POR - DAFG - ULR
	Bits per sample: 000b= 8 bits 001b= 16 bits 010b= 20 bits 011b= 24 bits 100b= 32 bits 101b-111b= Reserved			
NmbrChan	3:0	RW	1h	POR - DAFG - ULR
	Total number of channels in the stream assigned to this converter: 0000b-1111b= 1-16 channels.			

**7.16.4. ADC0 (NID = 15h): ProcState**

Reg	Byte 4 (Bits 31:24)	Byte 3 (Bits 23:16)	Byte 2 (Bits 15:8)	Byte 1 (Bits 7:0)
Set				703h
Get	F0300h			

Field Name	Bits	R/W	Default	Reset
Rsvd2	31:8	R	000000h	N/A (Hard-coded)
	Reserved.			
HPFOCDIS	7	RW	0h	POR - DAFG - ULR
	HPF offset calculation disable. 1 = calculation disabled; 0 = calculation enabled.			
Rsvd1	6:2	R	00h	N/A (Hard-coded)
	Reserved.			
ADCHPFByp	1:0	RW	1h	POR - DAFG - ULR
	Processing State: 00b= bypass the ADC HPF ("off"), 01b-11b= ADC HPF is enabled ("on" or "benign").			

#### 7.16.5. ADC0 (NID = 15h): PwrState

Reg	Byte 4 (Bits 31:24)	Byte 3 (Bits 23:16)	Byte 2 (Bits 15:8)	Byte 1 (Bits 7:0)
Set				705h
Get	F0500h			

Field Name	Bits	R/W	Default	Reset
Rsvd4	31:11	R	000000h	N/A (Hard-coded)
	Reserved.			
SettingsReset	10	R	1h	POR - DAFG - ULR
	Indicates if any persistent settings in this Widget have been reset. Cleared by PwrState 'Get', or a 'Set' to any Verb in this Widget.			
Rsvd3	9	R	0h	N/A (Hard-coded)
	Reserved.			
Error	8	R	0h	POR - DAFG - ULR
	Error indicator: 1 = cannot enter requested power state, 0 = no problem with requested power state.			
Rsvd2	7:6	R	0h	N/A (Hard-coded)
	Reserved.			

Field Name	Bits	R/W	Default	Reset
Act	5:4	R	3h	POR - DAFG - LR
	Actual power state of this widget.			
Rsvd1	3:2	R	0h	N/A (Hard-coded)
	Reserved.			
Set	1:0	RW	3h	POR - DAFG - LR
	Current power state setting for this widget.			

#### 7.16.6. ADC0 (NID = 15h): CnvtrID

Reg	Byte 4 (Bits 31:24)	Byte 3 (Bits 23:16)	Byte 2 (Bits 15:8)	Byte 1 (Bits 7:0)
Set				706h
Get	F0600h			

Field Name	Bits	R/W	Default	Reset
Rsvd	31:8	R	000000h	N/A (Hard-coded)
	Reserved.			
Strm	7:4	RW	0h	POR - S&DAFG - LR - PS
	Stream ID: 0h = Converter "off", 1h-Fh = valid ID's.			
Ch	3:0	RW	0h	POR - S&DAFG - LR - PS
	Channel assignment ("Ch" and "Ch+1" assigned as a pair, for a stereo converter).			

#### 7.17. ADC1 (NID = 1Bh): WCap

Reg	Byte 4 (Bits 31:24)	Byte 3 (Bits 23:16)	Byte 2 (Bits 15:8)	Byte 1 (Bits 7:0)
Set				
Get	F0009h			

Field Name	Bits	R/W	Default	Reset
Rsvd2	31:24	R	00h	N/A (Hard-coded)
	Reserved.			
Type	23:20	R	1h	N/A (Hard-coded)
	Widget type: 0h = Out Converter 1h = In Converter 2h = Summing (Mixer) 3h = Selector (Mux) 4h = Pin Complex 5h = Power 6h = Volume Knob 7h = Beep Generator 8h-Eh = Reserved Fh = Vendor Defined			
Delay	19:16	R	Dh	N/A (Hard-coded)
	Number of sample delays through widget.			
Rsvd1	15:12	R	0h	N/A (Hard-coded)
	Reserved.			
SwapCap	11	R	0h	N/A (Hard-coded)
	Left/right swap support: 1 = yes, 0 = no.			
PwrCntrl	10	R	1h	N/A (Hard-coded)
	Power state support: 1 = yes, 0 = no.			
Dig	9	R	0h	N/A (Hard-coded)
	Digital stream support: 1 = yes (digital), 0 = no (analog).			
ConnList	8	R	1h	N/A (Hard-coded)
	Connection list present: 1 = yes, 0 = no.			
UnSolCap	7	R	0h	N/A (Hard-coded)
	Unsolicited response support: 1 = yes, 0 = no.			
ProcWidget	6	R	1h	N/A (Hard-coded)
	Processing state support: 1 = yes, 0 = no.			
Stripe	5	R	0h	N/A (Hard-coded)
	Striping support: 1 = yes, 0 = no.			

Field Name	Bits	R/W	Default	Reset
FormatOvrd	4	R	0h	N/A (Hard-coded)
	Stream format override: 1 = yes, 0 = no.			
AmpParOvrd	3	R	0h	N/A (Hard-coded)
	Amplifier capabilities override: 1 = yes, no.			
OutAmpPrsnt	2	R	0h	N/A (Hard-coded)
	Output amp present: 1 = yes, 0 = no.			
InAmpPrsnt	1	R	0h	N/A (Hard-coded)
	Input amp present: 1 = yes, 0 = no.			
Stereo	0	R	1h	N/A (Hard-coded)
	Stereo stream support: 1 = yes (stereo), 0 = no (mono).			

#### 7.17.1. ADC1 (NID = 1Bh): ConLst

Reg	Byte 4 (Bits 31:24)	Byte 3 (Bits 23:16)	Byte 2 (Bits 15:8)	Byte 1 (Bits 7:0)
Set				
Get	F000Eh			

Field Name	Bits	R/W	Default	Reset
Rsvd	31:8	R	000000h	N/A (Hard-coded)
	Reserved.			
LForm	7	R	0h	N/A (Hard-coded)
	Connection list format: 1 = long-form (15-bit) NID entries, 0 = short-form (7-bit) NID entries.			
ConL	6:0	R	01h	N/A (Hard-coded)
	Number of NID entries in connection list.			

#### 7.17.2. ADC1 (NID = 1Bh): ConLstEntry0

Reg	Byte 4 (Bits 31:24)	Byte 3 (Bits 23:16)	Byte 2 (Bits 15:8)	Byte 1 (Bits 7:0)
Set				
Get	F0200h			



Field Name	Bits	R/W	Default	Reset
ConL3	31:24	R	00h	N/A (Hard-coded)
	Unused list entry.			
ConL2	23:16	R	00h	N/A (Hard-coded)
	Unused list entry.			
ConL1	15:8	R	00h	N/A (Hard-coded)
	Unused list entry.			
ConL0	7:0	R	18h	N/A (Hard-coded)
	ADC1Mux widget (0x18)			

### 7.17.3. ADC1 (NID = 1Bh): Cnvtr

Reg	Byte 4 (Bits 31:24)	Byte 3 (Bits 23:16)	Byte 2 (Bits 15:8)	Byte 1 (Bits 7:0)
Set				2h
Get	A0000h			

Field Name	Bits	R/W	Default	Reset
Rsvd2	31:16	R	0000h	N/A (Hard-coded)
	Reserved.			
StrmType	15	R	0h	N/A (Hard-coded)
	Stream type: 1 = Non-PCM, 0 = PCM.			
FrmtSmplRate	14	RW	0h	POR - DAFG - ULR
	Sample base rate: 1 = 44.1kHz, 0 = 48kHz.			
SmplRateMultp	13:11	RW	0h	POR - DAFG - ULR
	Sample base rate multiple: 000b= x1 (48kHz/44.1kHz or less) 001b= x2 (96kHz/88.2kHz/32kHz) 010b= x3 (144kHz) 011b= x4 (192kHz/176.4kHz) 100b-111b Reserved			

Field Name	Bits	R/W	Default	Reset
SmpIRateDiv	10:8	RW	0h	POR - DAFG - ULR
	Sample base rate divider: 000b= Divide by 1 (48kHz/44.1kHz) 001b= Divide by 2 (24kHz/20.05kHz) 010b= Divide by 3 (16kHz/32kHz) 011b= Divide by 4 (11.025kHz) 100b= Divide by 5 (9.6kHz) 101b= Divide by 6 (8kHz) 110b= Divide by 7 111b= Divide by 8 (6kHz)			
Rsvd1	7	R	0h	N/A (Hard-coded)
	Reserved.			
BitsPerSmpl	6:4	RW	3h	POR - DAFG - ULR
	Bits per sample: 000b= 8 bits 001b= 16 bits 010b= 20 bits 011b= 24 bits 100b= 32 bits 101b-111b= Reserved			
NmbrChan	3:0	RW	1h	POR - DAFG - ULR
	Total number of channels in the stream assigned to this converter: 0000b-1111b= 1-16 channels.			

#### 7.17.4. ADC1 (NID = 1Bh): ProcState

Reg	Byte 4 (Bits 31:24)	Byte 3 (Bits 23:16)	Byte 2 (Bits 15:8)	Byte 1 (Bits 7:0)
Set				703h
Get	F0300h			

Field Name	Bits	R/W	Default	Reset
Rsvd2	31:8	R	000000h	N/A (Hard-coded)
	Reserved.			
HPFOCDIS	7	RW	0h	POR - DAFG - ULR
	HPF offset calculation disable. 1 = calculation disabled; 0 = calculation enabled.			

Field Name	Bits	R/W	Default	Reset
Rsvd1	6:2	R	00h	N/A (Hard-coded)
	Reserved.			
ADCHPFByp	1:0	RW	1h	POR - DAFG - ULR
	Processing State: 00b= bypass the ADC HPF ("off"), 01b-11b= ADC HPF is enabled ("on" or "benign").			

### 7.17.5. ADC1 (NID = 1Bh): PwrState

Reg	Byte 4 (Bits 31:24)	Byte 3 (Bits 23:16)	Byte 2 (Bits 15:8)	Byte 1 (Bits 7:0)
Set				705h
Get	F0500h			

Field Name	Bits	R/W	Default	Reset
Rsvd4	31:11	R	000000h	N/A (Hard-coded)
	Reserved.			
SettingsReset	10	R	1h	POR - DAFG - ULR
	Indicates if any persistent settings in this Widget have been reset. Cleared by PwrState 'Get', or a 'Set' to any Verb in this Widget.			
Rsvd3	9	R	0h	N/A (Hard-coded)
	Reserved.			
Error	8	R	0h	POR - DAFG - ULR
	Error indicator: 1 = cannot enter requested power state, 0 = no problem with requested power state.			
Rsvd2	7:6	R	0h	N/A (Hard-coded)
	Reserved.			
Act	5:4	R	3h	POR - DAFG - LR
	Actual power state of this widget.			
Rsvd1	3:2	R	0h	N/A (Hard-coded)
	Reserved.			
Set	1:0	RW	3h	POR - DAFG - LR
	Current power state setting for this widget.			

**7.17.6. ADC1 (NID = 1Bh): CnvtrID**

Reg	Byte 4 (Bits 31:24)	Byte 3 (Bits 23:16)	Byte 2 (Bits 15:8)	Byte 1 (Bits 7:0)
Set				706h
Get	F0600h			

Field Name	Bits	R/W	Default	Reset
Rsvd	31:8	R	000000h	N/A (Hard-coded)
	Reserved.			
Strm	7:4	RW	0h	POR - S&DAFG - LR - PS
	Stream ID: 0h = Converter "off", 1h-Fh = valid ID's.			
Ch	3:0	RW	0h	POR - S&DAFG - LR - PS
	Channel assignment ("Ch" and "Ch+1" assigned as a pair, for a stereo converter).			

## 7.18. ADC0Mux (NID = 17h): WCap

Reg	Byte 4 (Bits 31:24)	Byte 3 (Bits 23:16)	Byte 2 (Bits 15:8)	Byte 1 (Bits 7:0)
Set				
Get	F0009h			

Field Name	Bits	R/W	Default	Reset
Rsvd2	31:24	R	00h	N/A (Hard-coded)
	Reserved.			
Type	23:20	R	3h	N/A (Hard-coded)
	Widget type: 0h = Out Converter 1h = In Converter 2h = Summing (Mixer) 3h = Selector (Mux) 4h = Pin Complex 5h = Power 6h = Volume Knob 7h = Beep Generator 8h-Eh = Reserved Fh = Vendor Defined			
Delay	19:16	R	0h	N/A (Hard-coded)
	Number of sample delays through widget.			
Rsvd1	15:12	R	0h	N/A (Hard-coded)
	Reserved.			
SwapCap	11	R	1h	N/A (Hard-coded)
	Left/right swap support: 1 = yes, 0 = no.			
PwrCntrl	10	R	1h	N/A (Hard-coded)
	Power state support: 1 = yes, 0 = no.			
DigitalStrm	9	R	0h	N/A (Hard-coded)
	Digital stream support: 1 = yes (digital), 0 = no (analog).			
ConnList	8	R	1h	N/A (Hard-coded)
	Connection list present: 1 = yes, 0 = no.			

Field Name	Bits	R/W	Default	Reset
UnsolCap	7	R	0h	N/A (Hard-coded)
	Unsolicted response support: 1 = yes, 0 = no.			
ProcWidget	6	R	0h	N/A (Hard-coded)
	Processing state support: 1 = yes, 0 = no.			
Stripe	5	R	0h	N/A (Hard-coded)
	Striping support: 1 = yes, 0 = no.			
FormatOvrd	4	R	0h	N/A (Hard-coded)
	Stream format override: 1 = yes, 0 = no.			
AmpParamOvrd	3	R	1h	N/A (Hard-coded)
	Amplifier capabilities override: 1 = yes, no.			
OutAmpPrsnt	2	R	1h	N/A (Hard-coded)
	Output amp present: 1 = yes, 0 = no.			
InAmpPrsnt	1	R	0h	N/A (Hard-coded)
	Input amp present: 1 = yes, 0 = no.			
Stereo	0	R	1h	N/A (Hard-coded)
	Stereo stream support: 1 = yes (stereo), 0 = no (mono).			

### 7.18.1. ADC0Mux (NID = 17h): ConLst

Reg	Byte 4 (Bits 31:24)	Byte 3 (Bits 23:16)	Byte 2 (Bits 15:8)	Byte 1 (Bits 7:0)
Set				
Get	F000Eh			

Field Name	Bits	R/W	Default	Reset
Rsvd	31:8	R	000000h	N/A (Hard-coded)
	Reserved.			

Field Name	Bits	R/W	Default	Reset
LForm	7	R	0h	N/A (Hard-coded)
	Connection list format: 1 = long-form (15-bit) NID entries, 0 = short-form (7-bit) NID entries.			
ConL	6:0	R	05h	N/A (Hard-coded)
	Number of NID entries in connection list.			

### 7.18.2. ADC0Mux (NID = 17h): ConLstEntry4

Reg	Byte 4 (Bits 31:24)	Byte 3 (Bits 23:16)	Byte 2 (Bits 15:8)	Byte 1 (Bits 7:0)
Set				
Get	F0204h			

Field Name	Bits	R/W	Default	Reset
ConL7	31:24	R	00h	N/A (Hard-coded)
	Unused list entry.			
ConL6	23:16	R	00h	N/A (Hard-coded)
	Reserved			
ConL5	15:8	R	00h	N/A (Hard-coded)
	Reserved			
ConL4	7:0	R	11h	N/A (Hard-coded)
	DMIC0 widget (0x11)			

### 7.18.3. ADC0Mux (NID = 17h): ConLstEntry0

Reg	Byte 4 (Bits 31:24)	Byte 3 (Bits 23:16)	Byte 2 (Bits 15:8)	Byte 1 (Bits 7:0)
Set				
Get	F0200h			

Field Name	Bits	R/W	Default	Reset
ConL3	31:24	R	0Fh	N/A (Hard-coded)
	Port F Pin widget (0x0F)			
ConL2	23:16	R	0Ch	N/A (Hard-coded)
	Port C Pin widget (0x0C)			
ConL1	15:8	R	0Ah	N/A (Hard-coded)
	Port A Pin widget (0x0A)			
ConL0	7:0	R	1Bh	N/A (Hard-coded)
	Mixer Summing widget (0x1B)			

#### 7.18.4. ADC0Mux (NID = 17h): OutAmpCap

Reg	Byte 4 (Bits 31:24)	Byte 3 (Bits 23:16)	Byte 2 (Bits 15:8)	Byte 1 (Bits 7:0)
Set				
Get	F0012h			

Field Name	Bits	R/W	Default	Reset
Mute	31	R	1h	N/A (Hard-coded)
	Mute support: 1 = yes, 0 = no.			
Rsvd3	30:23	R	00h	N/A (Hard-coded)
	Reserved.			
StepSize	22:16	R	03h	N/A (Hard-coded)
	Size of each step in the gain range: 0 to 127 = .25dB to 32dB, in .25dB steps.			
Rsvd2	15	R	0h	N/A (Hard-coded)
	Reserved.			
NumSteps	14:8	R	2Eh	N/A (Hard-coded)
	Number of gains steps (number of possible settings - 1).			



Field Name	Bits	R/W	Default	Reset
Rsvd1	7	R	0h	N/A (Hard-coded)
	Reserved.			
Offset	6:0	R	10h	N/A (Hard-coded)
	Indicates which step is 0dB			

#### 7.18.5. ADC0Mux (NID = 17h): OutAmpLeft

Reg	Byte 4 (Bits 31:24)	Byte 3 (Bits 23:16)	Byte 2 (Bits 15:8)	Byte 1 (Bits 7:0)
Set				3A0h
Get	BA000h			

Field Name	Bits	R/W	Default	Reset
Rsvd2	31:8	R	000000h	N/A (Hard-coded)
	Reserved.			
Mute	7	RW	1h	POR - DAFG - ULR
	Amp mute: 1 = muted, 0 = not muted.			
Rsvd1	6	R	0h	N/A (Hard-coded)
	Reserved.			
Gain	5:0	RW	10h	POR - DAFG - ULR
	Amp gain step number (see OutAmpCap parameter pertaining to this widget).			

#### 7.18.6. ADC0Mux (NID = 17h): OutAmpRight

Reg	Byte 4 (Bits 31:24)	Byte 3 (Bits 23:16)	Byte 2 (Bits 15:8)	Byte 1 (Bits 7:0)
Set				390h
Get	B8000h			

Field Name	Bits	R/W	Default	Reset
Rsvd2	31:8	R	000000h	N/A (Hard-coded)
	Reserved.			
Mute	7	RW	1h	POR - DAFG - ULR
	Amp mute: 1 = muted, 0 = not muted.			
Rsvd1	6	R	0h	N/A (Hard-coded)
	Reserved.			
Gain	5:0	RW	10h	POR - DAFG - ULR
	Amp gain step number (see OutAmpCap parameter pertaining to this widget).			

#### 7.18.7. ADC0Mux (NID = 17h): ConSelectCtrl

Reg	Byte 4 (Bits 31:24)	Byte 3 (Bits 23:16)	Byte 2 (Bits 15:8)	Byte 1 (Bits 7:0)
Set				701h
Get	F0100h			

Field Name	Bits	R/W	Default	Reset
Rsvd	31:3	R	00000000h	N/A (Hard-coded)
	Reserved.			
Index	2:0	RW	0h	POR - DAFG - ULR
	Connection select control index.			

#### 7.18.8. ADC0Mux (NID = 17h): PwrState

Reg	Byte 4 (Bits 31:24)	Byte 3 (Bits 23:16)	Byte 2 (Bits 15:8)	Byte 1 (Bits 7:0)
Set				705h
Get	F0500h			

Field Name	Bits	R/W	Default	Reset
Rsvd4	31:11	R	000000h	N/A (Hard-coded)
	Reserved.			
SettingsReset	10	R	1h	POR - DAFG - ULR
	Indicates if any persistent settings in this Widget have been reset. Cleared by PwrState 'Get', or a 'Set' to any Verb in this Widget.			
Rsvd3	9	R	0h	N/A (Hard-coded)
	Reserved.			
Error	8	R	0h	POR - DAFG - ULR
	Error indicator: 1 = cannot enter requested power state, 0 = no problem with requested power state.			
Rsvd2	7:6	R	0h	N/A (Hard-coded)
	Reserved.			
Act	5:4	R	3h	POR - DAFG - LR
	Actual power state of this widget.			
Rsvd1	3:2	R	0h	N/A (Hard-coded)
	Reserved.			
Set	1:0	RW	0h	POR - DAFG - LR
	Current power state setting for this widget.			

#### 7.18.9. ADC0Mux (NID = 17h): EAPDBTLLR

Reg	Byte 4 (Bits 31:24)	Byte 3 (Bits 23:16)	Byte 2 (Bits 15:8)	Byte 1 (Bits 7:0)
Set				70Ch
Get	F0C00h			

Field Name	Bits	R/W	Default	Reset
Rsvd2	31:3	R	00000000h	N/A (Hard-coded)
	Reserved.			
SwapEn	2	RW	0h	POR - DAFG - ULR
	Swap enable: 1 = L/R swap enabled, 0 = L/R swap disabled.			
Rsvd1	1:0	R	0h	N/A (Hard-coded)
	Reserved.			

### 7.19. ADC1Mux (NID = 18h): WCap

Reg	Byte 4 (Bits 31:24)	Byte 3 (Bits 23:16)	Byte 2 (Bits 15:8)	Byte 1 (Bits 7:0)
Set				
Get	F0009h			

Field Name	Bits	R/W	Default	Reset
Rsvd2	31:24	R	00h	N/A (Hard-coded)
	Reserved.			
Type	23:20	R	3h	N/A (Hard-coded)
Widget type: 0h = Out Converter 1h = In Converter 2h = Summing (Mixer) 3h = Selector (Mux) 4h = Pin Complex 5h = Power 6h = Volume Knob 7h = Beep Generator 8h-Eh = Reserved Fh = Vendor Defined				
Delay	19:16	R	0h	N/A (Hard-coded)
	Number of sample delays through widget.			

# 92HD99

## SINGLE CHIP PC AUDIO SYSTEM, CODEC+SPEAKER AMPLIFIER+CAPLESS HP+LDO

Field Name	Bits	R/W	Default	Reset
Rsvd1	15:12	R	0h	N/A (Hard-coded)
	Reserved.			
SwapCap	11	R	1h	N/A (Hard-coded)
	Left/right swap support: 1 = yes, 0 = no.			
PwrCntrl	10	R	1h	N/A (Hard-coded)
	Power state support: 1 = yes, 0 = no.			
DigitalStrm	9	R	0h	N/A (Hard-coded)
	Digital stream support: 1 = yes (digital), 0 = no (analog).			
ConnList	8	R	1h	N/A (Hard-coded)
	Connection list present: 1 = yes, 0 = no.			
UnsolCap	7	R	0h	N/A (Hard-coded)
	Unsolicited response support: 1 = yes, 0 = no.			
ProcWidget	6	R	0h	N/A (Hard-coded)
	Processing state support: 1 = yes, 0 = no.			
Stripe	5	R	0h	N/A (Hard-coded)
	Striping support: 1 = yes, 0 = no.			
FormatOvrd	4	R	0h	N/A (Hard-coded)
	Stream format override: 1 = yes, 0 = no.			
AmpParamOvrd	3	R	1h	N/A (Hard-coded)
	Amplifier capabilities override: 1 = yes, no.			
OutAmpPrsnt	2	R	1h	N/A (Hard-coded)
	Output amp present: 1 = yes, 0 = no.			
InAmpPrsnt	1	R	0h	N/A (Hard-coded)
	Input amp present: 1 = yes, 0 = no.			
Stereo	0	R	1h	N/A (Hard-coded)
	Stereo stream support: 1 = yes (stereo), 0 = no (mono).			

## 7.19.1. ADC1Mux (NID = 18h): ConLst

Reg	Byte 4 (Bits 31:24)	Byte 3 (Bits 23:16)	Byte 2 (Bits 15:8)	Byte 1 (Bits 7:0)
Set				
Get	F000Eh			

Field Name	Bits	R/W	Default	Reset
Rsvd	31:8	R	000000h	N/A (Hard-coded)
	Reserved.			
LForm	7	R	0h	N/A (Hard-coded)
	Connection list format: 1 = long-form (15-bit) NID entries, 0 = short-form (7-bit) NID entries.			
ConL	6:0	R	05h	N/A (Hard-coded)
	Number of NID entries in connection list.			

## 7.19.2. ADC1Mux (NID = 18h): ConLstEntry4

Reg	Byte 4 (Bits 31:24)	Byte 3 (Bits 23:16)	Byte 2 (Bits 15:8)	Byte 1 (Bits 7:0)
Set				
Get	F0204h			

Field Name	Bits	R/W	Default	Reset
ConL7	31:24	R	00h	N/A (Hard-coded)
	Unused list entry.			
ConL6	23:16	R	00h	N/A (Hard-coded)
	Reserved.			
ConL5	15:8	R	00h	N/A (Hard-coded)
	Reserved			
ConL4	7:0	R	11h	N/A (Hard-coded)
	DMIC0 widget (0x11)			

**7.19.3. ADC1Mux (NID = 18h): ConLstEntry0**

Reg	Byte 4 (Bits 31:24)	Byte 3 (Bits 23:16)	Byte 2 (Bits 15:8)	Byte 1 (Bits 7:0)
Set				
Get	F0200h			

Field Name	Bits	R/W	Default	Reset
ConL3	31:24	R	0Fh	N/A (Hard-coded)
	Port F Pin widget (0x0F)			
ConL2	23:16	R	0Ch	N/A (Hard-coded)
	Port C Pin widget (0x0C)			
ConL1	15:8	R	0Ah	N/A (Hard-coded)
	Port A Pin widget (0x0A)			
ConL0	7:0	R	1Bh	N/A (Hard-coded)
	Mixer Summing widget (0x1B)			

**7.19.4. ADC1Mux (NID = 18h): OutAmpCap**

Reg	Byte 4 (Bits 31:24)	Byte 3 (Bits 23:16)	Byte 2 (Bits 15:8)	Byte 1 (Bits 7:0)
Set				
Get	F0012h			

Field Name	Bits	R/W	Default	Reset
Mute	31	R	1h	N/A (Hard-coded)
	Mute support: 1 = yes, 0 = no.			
Rsvd3	30:23	R	00h	N/A (Hard-coded)
	Reserved.			
StepSize	22:16	R	03h	N/A (Hard-coded)
	Size of each step in the gain range: 0 to 127 = .25dB to 32dB, in .25dB steps.			
Rsvd2	15	R	0h	N/A (Hard-coded)
	Reserved.			

Field Name	Bits	R/W	Default	Reset
NumSteps	14:8	R	2Eh	N/A (Hard-coded)
	Number of gains steps (number of possible settings - 1).			
Rsvd1	7	R	0h	N/A (Hard-coded)
	Reserved.			
Offset	6:0	R	10h	N/A (Hard-coded)
	Indicates which step is 0dB			

#### 7.19.5. ADC1Mux (NID = 18h): OutAmpLeft

Reg	Byte 4 (Bits 31:24)	Byte 3 (Bits 23:16)	Byte 2 (Bits 15:8)	Byte 1 (Bits 7:0)
Set				3A0h
Get	BA000h			

Field Name	Bits	R/W	Default	Reset
Rsvd2	31:8	R	000000h	N/A (Hard-coded)
	Reserved.			
Mute	7	RW	1h	POR - DAFG - ULR
	Amp mute: 1 = muted, 0 = not muted.			
Rsvd1	6	R	0h	N/A (Hard-coded)
	Reserved.			
Gain	5:0	RW	10h	POR - DAFG - ULR
	Amp gain step number (see OutAmpCap parameter pertaining to this widget).			

#### 7.19.6. ADC1Mux (NID = 18h): OutAmpRight

Reg	Byte 4 (Bits 31:24)	Byte 3 (Bits 23:16)	Byte 2 (Bits 15:8)	Byte 1 (Bits 7:0)
Set				390h
Get	B8000h			



Field Name	Bits	R/W	Default	Reset
Rsvd2	31:8	R	000000h	N/A (Hard-coded)
	Reserved.			
Mute	7	RW	1h	POR - DAFG - ULR
	Amp mute: 1 = muted, 0 = not muted.			
Rsvd1	6	R	0h	N/A (Hard-coded)
	Reserved.			
Gain	5:0	RW	10h	POR - DAFG - ULR
	Amp gain step number (see OutAmpCap parameter pertaining to this widget).			

#### 7.19.7. ADC1Mux (NID = 18h): ConSelectCtrl

Reg	Byte 4 (Bits 31:24)	Byte 3 (Bits 23:16)	Byte 2 (Bits 15:8)	Byte 1 (Bits 7:0)
Set				701h
Get	F0100h			

Field Name	Bits	R/W	Default	Reset
Rsvd	31:3	R	00000000h	N/A (Hard-coded)
	Reserved.			
Index	2:0	RW	0h	POR - DAFG - ULR
	Connection select control index.			

#### 7.19.8. ADC1Mux (NID = 18h): PwrState

Reg	Byte 4 (Bits 31:24)	Byte 3 (Bits 23:16)	Byte 2 (Bits 15:8)	Byte 1 (Bits 7:0)
Set				705h
Get	F0500h			

Field Name	Bits	R/W	Default	Reset
Rsvd4	31:11	R	000000h	N/A (Hard-coded)
	Reserved.			

Field Name	Bits	R/W	Default	Reset
SettingsReset	10	R	1h	POR - DAFG - ULR
	Indicates if any persistent settings in this Widget have been reset. Cleared by PwrState 'Get', or a 'Set' to any Verb in this Widget.			
Rsvd3	9	R	0h	N/A (Hard-coded)
	Reserved.			
Error	8	R	0h	POR - DAFG - ULR
	Error indicator: 1 = cannot enter requested power state, 0 = no problem with requested power state.			
Rsvd2	7:6	R	0h	N/A (Hard-coded)
	Reserved.			
Act	5:4	R	3h	POR - DAFG - LR
	Actual power state of this widget.			
Rsvd1	3:2	R	0h	N/A (Hard-coded)
	Reserved.			
Set	1:0	RW	0h	POR - DAFG - LR
	Current power state setting for this widget.			

#### 7.19.9. ADC1Mux (NID = 18h): EAPDBTLLR

Reg	Byte 4 (Bits 31:24)	Byte 3 (Bits 23:16)	Byte 2 (Bits 15:8)	Byte 1 (Bits 7:0)
Set				70Ch
Get	F0C00h			

Field Name	Bits	R/W	Default	Reset
Rsvd2	31:3	R	00000000h	N/A (Hard-coded)
	Reserved.			
SwapEn	2	RW	0h	POR - DAFG - ULR
	Swap enable: 1 = L/R swap enabled, 0 = L/R swap disabled.			
Rsvd1	1:0	R	0h	N/A (Hard-coded)
	Reserved.			

## 92HD99

SINGLE CHIP PC AUDIO SYSTEM, CODEC+SPEAKER AMPLIFIER+CAPLESS HP+LDO

---

7.20. (NID = 19h): Vendor Reserved

7.21. (NID = 1Ah): Vendor Reserved

## 7.22. Mixer (NID = 1Bh): WCap

Reg	Byte 4 (Bits 31:24)	Byte 3 (Bits 23:16)	Byte 2 (Bits 15:8)	Byte 1 (Bits 7:0)
Set				
Get	F0009h			

Field Name	Bits	R/W	Default	Reset
Rsvd2	31:24	R	00h	N/A (Hard-coded)
	Reserved.			
Type	23:20	R	2h	N/A (Hard-coded)
	Widget type: 0h = Out Converter 1h = In Converter 2h = Summing (Mixer) 3h = Selector (Mux) 4h = Pin Complex 5h = Power 6h = Volume Knob 7h = Beep Generator 8h-Eh = Reserved Fh = Vendor Defined			
Delay	19:16	R	0h	N/A (Hard-coded)
	Number of sample delays through widget.			
Rsvd1	15:12	R	0h	N/A (Hard-coded)
	Reserved.			
SwapCap	11	R	0h	N/A (Hard-coded)
	Left/right swap support: 1 = yes, 0 = no.			
PwrCntrl	10	R	1h	N/A (Hard-coded)
	Power state support: 1 = yes, 0 = no.			
Dig	9	R	0h	N/A (Hard-coded)
	Digital stream support: 1 = yes (digital), 0 = no (analog).			
ConnList	8	R	1h	N/A (Hard-coded)
	Connection list present: 1 = yes, 0 = no.			
UnSolCap	7	R	0h	N/A (Hard-coded)
	Unsolicited response support: 1 = yes, 0 = no.			

Field Name	Bits	R/W	Default	Reset
ProcWidget	6	R	0h	N/A (Hard-coded)
	Processing state support: 1 = yes, 0 = no.			
Stripe	5	R	0h	N/A (Hard-coded)
	Striping support: 1 = yes, 0 = no.			
FormatOvr	4	R	0h	N/A (Hard-coded)
	Stream format override: 1 = yes, 0 = no.			
AmpParOvr	3	R	1h	N/A (Hard-coded)
	Amplifier capabilities override: 1 = yes, no.			
OutAmpPrsnt	2	R	0h	N/A (Hard-coded)
	Output amp present: 1 = yes, 0 = no.			
InAmpPrsnt	1	R	1h	N/A (Hard-coded)
	Input amp present: 1 = yes, 0 = no.			
Stereo	0	R	1h	N/A (Hard-coded)
	Stereo stream support: 1 = yes (stereo), 0 = no (mono).			

### 7.22.1. Mixer (NID = 1Bh): InAmpCap

Reg	Byte 4 (Bits 31:24)	Byte 3 (Bits 23:16)	Byte 2 (Bits 15:8)	Byte 1 (Bits 7:0)
Set				
Get	F000Dh			

Field Name	Bits	R/W	Default	Reset
Mute	31	R	1h	N/A (Hard-coded)
	Mute support: 1 = yes, 0 = no.			
Rsvd3	30:23	R	00h	N/A (Hard-coded)
	Reserved.			
StepSize	22:16	R	05h	N/A (Hard-coded)
	Size of each step in the gain range: 0 to 127 = .25dB to 32dB, in .25dB steps.			

Field Name	Bits	R/W	Default	Reset
Rsvd2	15	R	0h	N/A (Hard-coded)
	Reserved.			
NumSteps	14:8	R	1Fh	N/A (Hard-coded)
	Number of gains steps (number of possible settings - 1).			
Rsvd1	7	R	0h	N/A (Hard-coded)
	Reserved.			
Offset	6:0	R	17h	N/A (Hard-coded)
	Indicates which step is 0dB			

### 7.22.2. Mixer (NID = 1Bh): ConLst

Reg	Byte 4 (Bits 31:24)	Byte 3 (Bits 23:16)	Byte 2 (Bits 15:8)	Byte 1 (Bits 7:0)
Set				
Get	F000Eh			

Field Name	Bits	R/W	Default	Reset
Rsvd	31:8	R	000000h	N/A (Hard-coded)
	Reserved.			
LForm	7	R	0h	N/A (Hard-coded)
	Connection list format: 1 = long-form (15-bit) NID entries, 0 = short-form (7-bit) NID entries.			
ConL	6:0	R	05h	N/A (Hard-coded)
	Number of NID entries in connection list.			

### 7.22.3. Mixer (NID = 1Bh): ConLstEntry4

Reg	Byte 4 (Bits 31:24)	Byte 3 (Bits 23:16)	Byte 2 (Bits 15:8)	Byte 1 (Bits 7:0)
Set				
Get	F0204h			

Field Name	Bits	R/W	Default	Reset
ConL7	31:24	R	00h	N/A (Hard-coded)
	Unused list entry.			
ConL6	23:16	R	00h	N/A (Hard-coded)
	Unused list entry.			
ConL5	15:8	R	00h	N/A (Hard-coded)
	Reserved			
ConL4	7:0	R	0FEh	N/A (Hard-coded)
	Port F Pin Widget (0x0F).			

#### 7.22.4. Mixer (NID = 1Bh): ConLstEntry0

Reg	Byte 4 (Bits 31:24)	Byte 3 (Bits 23:16)	Byte 2 (Bits 15:8)	Byte 1 (Bits 7:0)
Set				
Get	F0200h			

Field Name	Bits	R/W	Default	Reset
ConL3	31:24	R	0Ch	N/A (Hard-coded)
	Port C Pin widget (0x0C). Uses InAmpLeft3/InAmpRight3 controls.			
ConL2	23:16	R	0Ah	N/A (Hard-coded)
	Port A Pin widget (0x0A). Uses InAmpLeft2/InAmpRight2 controls.			
ConL1	15:8	R	14h	N/A (Hard-coded)
	DAC1 widget (0x14). Uses InAmpLeft1/InAmpRight1 controls.			
ConL0	7:0	R	13h	N/A (Hard-coded)
	DAC0 widget (0x13). Uses InAmpLeft0/InAmpRight0 controls.			

#### 7.22.5. Mixer (NID = 1Bh): InAmpLeft0

Reg	Byte 4 (Bits 31:24)	Byte 3 (Bits 23:16)	Byte 2 (Bits 15:8)	Byte 1 (Bits 7:0)
Set				360h
Get	B2000h			

Field Name	Bits	R/W	Default	Reset
Rsvd2	31:8	R	000000h	N/A (Hard-coded)
	Reserved.			
Mute	7	RW	1h	POR - DAFG - ULR
	Amp mute: 1 = muted, 0 = not muted.			
Rsvd1	6:5	R	0h	N/A (Hard-coded)
	Reserved.			
Gain	4:0	RW	17h	POR - DAFG - ULR
	Amp gain step number (see InAmpCap parameter pertaining to this widget).			

#### 7.22.6. Mixer (NID = 1Bh): InAmpRight0

Reg	Byte 4 (Bits 31:24)	Byte 3 (Bits 23:16)	Byte 2 (Bits 15:8)	Byte 1 (Bits 7:0)
Set				350h
Get	B0000h			

Field Name	Bits	R/W	Default	Reset
Rsvd2	31:8	R	000000h	N/A (Hard-coded)
	Reserved.			
Mute	7	RW	1h	POR - DAFG - ULR
	Amp mute: 1 = muted, 0 = not muted.			
Rsvd1	6:5	R	0h	N/A (Hard-coded)
	Reserved.			
Gain	4:0	RW	17h	POR - DAFG - ULR
	Amp gain step number (see InAmpCap parameter pertaining to this widget).			

#### 7.22.7. Mixer (NID = 1Bh): InAmpLeft1

Reg	Byte 4 (Bits 31:24)	Byte 3 (Bits 23:16)	Byte 2 (Bits 15:8)	Byte 1 (Bits 7:0)
Set				361h
Get	B2001h			



Field Name	Bits	R/W	Default	Reset
Rsvd2	31:8	R	000000h	N/A (Hard-coded)
	Reserved.			
Mute	7	RW	1h	POR - DAFG - ULR
	Amp mute: 1 = muted, 0 = not muted.			
Rsvd1	6:5	R	0h	N/A (Hard-coded)
	Reserved.			
Gain	4:0	RW	17h	POR - DAFG - ULR
	Amp gain step number (see InAmpCap parameter pertaining to this widget).			

#### 7.22.8. Mixer (NID = 1Bh): InAmpRight1

Reg	Byte 4 (Bits 31:24)	Byte 3 (Bits 23:16)	Byte 2 (Bits 15:8)	Byte 1 (Bits 7:0)
Set				351h
Get	B0001h			

Field Name	Bits	R/W	Default	Reset
Rsvd2	31:8	R	000000h	N/A (Hard-coded)
	Reserved.			
Mute	7	RW	1h	POR - DAFG - ULR
	Amp mute: 1 = muted, 0 = not muted.			
Rsvd1	6:5	R	0h	N/A (Hard-coded)
	Reserved.			
Gain	4:0	RW	17h	POR - DAFG - ULR
	Amp gain step number (see InAmpCap parameter pertaining to this widget).			

#### 7.22.9. Mixer (NID = 1Bh): InAmpLeft2

Reg	Byte 4 (Bits 31:24)	Byte 3 (Bits 23:16)	Byte 2 (Bits 15:8)	Byte 1 (Bits 7:0)
Set				362h
Get	B2002h			

Field Name	Bits	R/W	Default	Reset
Rsvd2	31:8	R	000000h	N/A (Hard-coded)
	Reserved.			
Mute	7	RW	1h	POR - DAFG - ULR
	Amp mute: 1 = muted, 0 = not muted.			
Rsvd1	6:5	R	0h	N/A (Hard-coded)
	Reserved.			
Gain	4:0	RW	17h	POR - DAFG - ULR
	Amp gain step number (see InAmpCap parameter pertaining to this widget).			

#### 7.22.10. Mixer (NID = 1Bh): InAmpRight2

Reg	Byte 4 (Bits 31:24)	Byte 3 (Bits 23:16)	Byte 2 (Bits 15:8)	Byte 1 (Bits 7:0)
Set				352h
Get	B0002h			

Field Name	Bits	R/W	Default	Reset
Rsvd2	31:8	R	000000h	N/A (Hard-coded)
	Reserved.			
Mute	7	RW	1h	POR - DAFG - ULR
	Amp mute: 1 = muted, 0 = not muted.			
Rsvd1	6:5	R	0h	N/A (Hard-coded)
	Reserved.			
Gain	4:0	RW	17h	POR - DAFG - ULR
	Amp gain step number (see InAmpCap parameter pertaining to this widget).			

#### 7.22.11. Mixer (NID = 1Bh): InAmpLeft3

Reg	Byte 4 (Bits 31:24)	Byte 3 (Bits 23:16)	Byte 2 (Bits 15:8)	Byte 1 (Bits 7:0)
Set				363h
Get	B2003h			

Field Name	Bits	R/W	Default	Reset
Rsvd2	31:8	R	000000h	N/A (Hard-coded)
	Reserved.			
Mute	7	RW	1h	POR - DAFG - ULR
	Amp mute: 1 = muted, 0 = not muted.			
Rsvd1	6:5	R	0h	N/A (Hard-coded)
	Reserved.			
Gain	4:0	RW	17h	POR - DAFG - ULR
	Amp gain step number (see InAmpCap parameter pertaining to this widget).			

#### 7.22.12. Mixer (NID = 1Bh): InAmpRight3

Reg	Byte 4 (Bits 31:24)	Byte 3 (Bits 23:16)	Byte 2 (Bits 15:8)	Byte 1 (Bits 7:0)
Set				353h
Get	B0003h			

Field Name	Bits	R/W	Default	Reset
Rsvd2	31:8	R	000000h	N/A (Hard-coded)
	Reserved.			
Mute	7	RW	1h	POR - DAFG - ULR
	Amp mute: 1 = muted, 0 = not muted.			
Rsvd1	6:5	R	0h	N/A (Hard-coded)
	Reserved.			
Gain	4:0	RW	17h	POR - DAFG - ULR
	Amp gain step number (see InAmpCap parameter pertaining to this widget).			

#### 7.22.13. Mixer (NID = 1Bh): InAmpLeft4

Reg	Byte 4 (Bits 31:24)	Byte 3 (Bits 23:16)	Byte 2 (Bits 15:8)	Byte 1 (Bits 7:0)
Set				364h
Get	B2004h			

Field Name	Bits	R/W	Default	Reset
Rsvd2	31:8	R	000000h	N/A (Hard-coded)
	Reserved.			
Mute	7	RW	1h	POR - DAFG - ULR
	Amp mute: 1 = muted, 0 = not muted.			
Rsvd1	6:5	R	0h	N/A (Hard-coded)
	Reserved.			
Gain	4:0	RW	17h	POR - DAFG - ULR
	Amp gain step number (see InAmpCap parameter pertaining to this widget).			

#### 7.22.14. Mixer (NID = 1Bh): InAmpRight4

Reg	Byte 4 (Bits 31:24)	Byte 3 (Bits 23:16)	Byte 2 (Bits 15:8)	Byte 1 (Bits 7:0)
Set				354h
Get	B0004h			

Field Name	Bits	R/W	Default	Reset
Rsvd2	31:8	R	000000h	N/A (Hard-coded)
	Reserved.			
Mute	7	RW	1h	POR - DAFG - ULR
	Amp mute: 1 = muted, 0 = not muted.			
Rsvd1	6:5	R	0h	N/A (Hard-coded)
	Reserved.			
Gain	4:0	RW	17h	POR - DAFG - ULR
	Amp gain step number (see InAmpCap parameter pertaining to this widget).			

#### 7.22.15. Mixer (NID = 1Bh): InAmpLeft5

Reg	Byte 4 (Bits 31:24)	Byte 3 (Bits 23:16)	Byte 2 (Bits 15:8)	Byte 1 (Bits 7:0)
Set				365h
Get	B2005h			

Field Name	Bits	R/W	Default	Reset
Rsvd2	31:8	R	000000h	N/A (Hard-coded)
	Reserved.			
Mute	7	RW	1h	POR - DAFG - ULR
	Amp mute: 1 = muted, 0 = not muted.			
Rsvd1	6:5	R	0h	N/A (Hard-coded)
	Reserved.			
Gain	4:0	RW	17h	POR - DAFG - ULR
	Amp gain step number (see InAmpCap parameter pertaining to this widget).			

#### 7.22.16. Mixer (NID = 1Bh): InAmpRight5

Reg	Byte 4 (Bits 31:24)	Byte 3 (Bits 23:16)	Byte 2 (Bits 15:8)	Byte 1 (Bits 7:0)
Set				355h
Get	B0005h			

Field Name	Bits	R/W	Default	Reset
Rsvd2	31:8	R	000000h	N/A (Hard-coded)
	Reserved.			
Mute	7	RW	1h	POR - DAFG - ULR
	Amp mute: 1 = muted, 0 = not muted.			
Rsvd1	6:5	R	0h	N/A (Hard-coded)
	Reserved.			
Gain	4:0	RW	17h	POR - DAFG - ULR
	Amp gain step number (see InAmpCap parameter pertaining to this widget).			

#### 7.22.17. Mixer (NID = 1Bh): PwrState

Reg	Byte 4 (Bits 31:24)	Byte 3 (Bits 23:16)	Byte 2 (Bits 15:8)	Byte 1 (Bits 7:0)
Set				705h
Get	F0500h			

Field Name	Bits	R/W	Default	Reset
Rsvd4	31:11	R	000000h	N/A (Hard-coded)
	Reserved.			
SettingsReset	10	R	1h	POR - DAFG - ULR
	Indicates if any persistent settings in this Widget have been reset. Cleared by PwrState 'Get', or a 'Set' to any Verb in this Widget.			
Rsvd3	9	R	0h	N/A (Hard-coded)
	Reserved.			
Error	8	R	0h	POR - DAFG - ULR
	Error indicator: 1 = cannot enter requested power state, 0 = no problem with requested power state.			
Rsvd2	7:6	R	0h	N/A (Hard-coded)
	Reserved.			
Act	5:4	R	3h	POR - DAFG - LR
	Actual power state of this widget.			
Rsvd1	3:2	R	0h	N/A (Hard-coded)
	Reserved.			
Set	1:0	RW	0h	POR - DAFG - LR
	Current power state setting for this widget.			

### 7.23. MixerOutVol (NID = 1Ch): WCap

Reg	Byte 4 (Bits 31:24)	Byte 3 (Bits 23:16)	Byte 2 (Bits 15:8)	Byte 1 (Bits 7:0)
Set				
Get	F0009h			

Field Name	Bits	R/W	Default	Reset
Rsvd2	31:24	R	00h	N/A (Hard-coded)
	Reserved.			

# 92HD99

## SINGLE CHIP PC AUDIO SYSTEM, CODEC+SPEAKER AMPLIFIER+CAPLESS HP+LDO

Field Name	Bits	R/W	Default	Reset
Type	23:20	R	3h	N/A (Hard-coded)
Widget type: 0h = Out Converter 1h = In Converter 2h = Summing (Mixer) 3h = Selector (Mux) 4h = Pin Complex 5h = Power 6h = Volume Knob 7h = Beep Generator 8h-Eh = Reserved Fh = Vendor Defined				
Delay	19:16	R	0h	N/A (Hard-coded)
Number of sample delays through widget.				
Rsvd1	15:12	R	0h	N/A (Hard-coded)
Reserved.				
SwapCap	11	R	0h	N/A (Hard-coded)
Left/right swap support: 1 = yes, 0 = no.				
PwrCntrl	10	R	1h	N/A (Hard-coded)
Power state support: 1 = yes, 0 = no.				
Dig	9	R	0h	N/A (Hard-coded)
Digital stream support: 1 = yes (digital), 0 = no (analog).				
ConnList	8	R	1h	N/A (Hard-coded)
Connection list present: 1 = yes, 0 = no.				
UnSolCap	7	R	0h	N/A (Hard-coded)
Unsolicited response support: 1 = yes, 0 = no.				
ProcWidget	6	R	0h	N/A (Hard-coded)
Processing state support: 1 = yes, 0 = no.				
Stripe	5	R	0h	N/A (Hard-coded)
Striping support: 1 = yes, 0 = no.				
FormatOvrd	4	R	0h	N/A (Hard-coded)
Stream format override: 1 = yes, 0 = no.				

Field Name	Bits	R/W	Default	Reset
AmpParOvrd	3	R	1h	N/A (Hard-coded)
Amplifier capabilities override: 1 = yes, no.				
OutAmpPrsnt	2	R	1h	N/A (Hard-coded)
Output amp present: 1 = yes, 0 = no.				
InAmpPrsnt	1	R	0h	N/A (Hard-coded)
Input amp present: 1 = yes, 0 = no.				
Stereo	0	R	1h	N/A (Hard-coded)
Stereo stream support: 1 = yes (stereo), 0 = no (mono).				

### 7.23.1. MixerOutVol (NID = 1Ch): ConLst

Reg	Byte 4 (Bits 31:24)	Byte 3 (Bits 23:16)	Byte 2 (Bits 15:8)	Byte 1 (Bits 7:0)
Set				
Get	F000Eh			

Field Name	Bits	R/W	Default	Reset
Rsvd	31:8	R	000000h	N/A (Hard-coded)
Reserved.				
LForm	7	R	0h	N/A (Hard-coded)
Connection list format: 1 = long-form (15-bit) NID entries, 0 = short-form (7-bit) NID entries.				
ConL	6:0	R	01h	N/A (Hard-coded)
Number of NID entries in connection list.				

### 7.23.2. MixerOutVol (NID = 1Ch): ConLstEntry0

Reg	Byte 4 (Bits 31:24)	Byte 3 (Bits 23:16)	Byte 2 (Bits 15:8)	Byte 1 (Bits 7:0)
Set				
Get	F0200h			



Field Name	Bits	R/W	Default	Reset
ConL3	31:24	R	00h	N/A (Hard-coded)
	Unused list entry.			
ConL2	23:16	R	00h	N/A (Hard-coded)
	Unused list entry.			
ConL1	15:8	R	00h	N/A (Hard-coded)
	Unused list entry.			
ConL0	7:0	R	1Bh	N/A (Hard-coded)
	Mixer Summing widget (0x1B)			

### 7.23.3. MixerOutVol (NID = 1Ch): OutAmpCap

Reg	Byte 4 (Bits 31:24)	Byte 3 (Bits 23:16)	Byte 2 (Bits 15:8)	Byte 1 (Bits 7:0)
Set				
Get	F0012h			

Field Name	Bits	R/W	Default	Reset
Mute	31	R	1h	N/A (Hard-coded)
	Mute support: 1 = yes, 0 = no.			
Rsvd3	30:23	R	00h	N/A (Hard-coded)
	Reserved.			
StepSize	22:16	R	05h	N/A (Hard-coded)
	Size of each step in the gain range: 0 to 127 = .25dB to 32dB, in .25dB steps.			
Rsvd2	15	R	0h	N/A (Hard-coded)
	Reserved.			
NumSteps	14:8	R	1Fh	N/A (Hard-coded)
	Number of gains steps (number of possible settings - 1).			
Rsvd1	7	R	0h	N/A (Hard-coded)
	Reserved.			

Field Name	Bits	R/W	Default	Reset
Offset	6:0	R	1Fh	N/A (Hard-coded)
Indicates which step is 0dB				

#### 7.23.4. MixerOutVol (NID = 1Ch): OutAmpLeft

Reg	Byte 4 (Bits 31:24)	Byte 3 (Bits 23:16)	Byte 2 (Bits 15:8)	Byte 1 (Bits 7:0)
Set				3A0h
Get	BA000h			

Field Name	Bits	R/W	Default	Reset
Rsvd2	31:8	R	000000h	N/A (Hard-coded)
Reserved.				
Mute	7	RW	1h	POR - DAFG - ULR
Amp mute: 1 = muted, 0 = not muted.				
Rsvd1	6:5	R	0h	N/A (Hard-coded)
Reserved.				
Gain	4:0	RW	1Fh	POR - DAFG - ULR
Amp gain step number (see OutAmpCap parameter pertaining to this widget).				

#### 7.23.5. MixerOutVol (NID = 1Ch): OutAmpRight

Reg	Byte 4 (Bits 31:24)	Byte 3 (Bits 23:16)	Byte 2 (Bits 15:8)	Byte 1 (Bits 7:0)
Set				390h
Get	B8000h			

Field Name	Bits	R/W	Default	Reset
Rsvd2	31:8	R	000000h	N/A (Hard-coded)
Reserved.				
Mute	7	RW	1h	POR - DAFG - ULR
Amp mute: 1 = muted, 0 = not muted.				

Field Name	Bits	R/W	Default	Reset
Rsvd1	6:5	R	0h	N/A (Hard-coded)
	Reserved.			
Gain	4:0	RW	1Fh	POR - DAFG - ULR
	Amp gain step number (see OutAmpCap parameter pertaining to this widget).			

### 7.23.6. MixerOutVol (NID = 1Ch): PwrState

Reg	Byte 4 (Bits 31:24)	Byte 3 (Bits 23:16)	Byte 2 (Bits 15:8)	Byte 1 (Bits 7:0)
Set				705h
Get	F0500h			

Field Name	Bits	R/W	Default	Reset
Rsvd4	31:11	R	000000h	N/A (Hard-coded)
	Reserved.			
SettingsReset	10	R	1h	POR - DAFG - ULR
	Indicates if any persistent settings in this Widget have been reset. Cleared by PwrState 'Get', or a 'Set' to any Verb in this Widget.			
Rsvd3	9	R	0h	N/A (Hard-coded)
	Reserved.			
Error	8	R	0h	POR - DAFG - ULR
	Error indicator: 1 = cannot enter requested power state, 0 = no problem with requested power state.			
Rsvd2	7:6	R	0h	N/A (Hard-coded)
	Reserved.			
Act	5:4	R	3h	POR - DAFG - LR
	Actual power state of this widget.			
Rsvd1	3:2	R	0h	N/A (Hard-coded)
	Reserved.			
Set	1:0	RW	0h	POR - DAFG - LR
	Current power state setting for this widget.			

**7.24. (NID = 1Dh): Vendor Reserved**

**7.25. (NID = 1Eh): Vendor Reserved**

**7.26. (NID = 1Fh): Vendor Reserved**

**7.27. (NID = 20h): Vendor Reserved**

## 7.28. DigBeep (NID = 21h): WCap

Reg	Byte 4 (Bits 31:24)	Byte 3 (Bits 23:16)	Byte 2 (Bits 15:8)	Byte 1 (Bits 7:0)
Set				
Get	F0009h			

Field Name	Bits	R/W	Default	Reset
Rsvd4	31:24	R	00h	N/A (Hard-coded)
	Reserved.			
Type	23:20	R	7h	N/A (Hard-coded)
	Widget type: 0h = Out Converter 1h = In Converter 2h = Summing (Mixer) 3h = Selector (Mux) 4h = Pin Complex 5h = Power 6h = Volume Knob 7h = Beep Generator 8h-Eh = Reserved Fh = Vendor Defined			
Rsvd3	19:11	R	0h	N/A (Hard-coded)
	Reserved.			
PwrCntrl	10	R	1h	N/A (Hard-coded)
	Power state support: 1 = yes, 0 = no."			
Rsvd2	9:4	R	0h	N/A (Hard-coded)
	Reserved			
AmpParOvr	3	R	1h	N/A (Hard-coded)
	Amplifier capabilities override: 1 = yes, no.			
OutAmpPrsnt	2	R	1h	N/A (Hard-coded)
	Output amp present: 1 = yes, 0 = no.			
Rsvd1	1:0	R	0h	N/A (Hard-coded)
	Reserved.			

**7.28.1. DigBeep (NID = 21h): OutAmpCap**

Reg	Byte 4 (Bits 31:24)	Byte 3 (Bits 23:16)	Byte 2 (Bits 15:8)	Byte 1 (Bits 7:0)
Set				
Get	F0012h			

Field Name	Bits	R/W	Default	Reset
Mute	31	R	1h	N/A (Hard-coded)
	Mute support: 1 = yes, 0 = no.			
Rsvd3	30:23	R	00h	N/A (Hard-coded)
	Reserved.			
StepSize	22:16	R	17h	N/A (Hard-coded)
	Size of each step in the gain range: 0 to 127 = .25dB to 32dB, in .25dB steps.			
Rsvd2	15	R	0h	N/A (Hard-coded)
	Reserved.			
NumSteps	14:8	R	03h	N/A (Hard-coded)
	Number of gains steps (number of possible settings - 1).			
Rsvd1	7	R	0h	N/A (Hard-coded)
	Reserved.			
Offset	6:0	R	03h	N/A (Hard-coded)
	Indicates which step is 0dB			

**7.28.2. DigBeep (NID = 21h): OutAmpLeft**

Reg	Byte 4 (Bits 31:24)	Byte 3 (Bits 23:16)	Byte 2 (Bits 15:8)	Byte 1 (Bits 7:0)
Set				3A0h
Get	BA000h			

Field Name	Bits	R/W	Default	Reset
Rsvd2	31:8	R	000000h	N/A (Hard-coded)
	Reserved.			

Field Name	Bits	R/W	Default	Reset
Mute	7	RW	0h	POR - DAFG - ULR
	Amp mute: 1 = muted, 0 = not muted.			
Rsvd1	6:2	R	00h	N/A (Hard-coded)
	Reserved.			
Gain	1:0	RW	1h	POR - DAFG - ULR
	Amp gain step number (see OutAmpCap parameter pertaining to this widget).			

### 7.28.3. DigBeep (NID = 21h): PwrState

Reg	Byte 4 (Bits 31:24)	Byte 3 (Bits 23:16)	Byte 2 (Bits 15:8)	Byte 1 (Bits 7:0)
Set				705h
Get	F0500h			

Field Name	Bits	R/W	Default	Reset
Rsvd4	31:11	R	000000h	N/A (Hard-coded)
	Reserved.			
SettingsReset	10	R	1h	POR - DAFG - ULR
	Indicates if any persistent settings in this Widget have been reset. Cleared by PwrState 'Get', or a 'Set' to any Verb in this Widget.			
Rsvd3	9	R	0h	N/A (Hard-coded)
	Reserved.			
Error	8	R	0h	POR - DAFG - ULR
	Error indicator: 1 = cannot enter requested power state, 0 = no problem with requested power state.			
Rsvd2	7:6	R	0h	N/A (Hard-coded)
	Reserved.			
Act	5:4	R	3h	POR - DAFG - LR
	Actual power state of this widget.			
Rsvd1	3:2	R	0h	N/A (Hard-coded)
	Reserved.			

Field Name	Bits	R/W	Default	Reset
Set	1:0	RW	0h	POR - DAFG - LR
Current power state setting for this widget.				

#### 7.28.4. DigBeep (NID = 21h): Gen

Reg	Byte 4 (Bits 31:24)	Byte 3 (Bits 23:16)	Byte 2 (Bits 15:8)	Byte 1 (Bits 7:0)
Set				70Ah
Get	F0A00h			

Field Name	Bits	R/W	Default	Reset
Rsvd	31:8	R	000000h	N/A (Hard-coded)
Reserved.				
Divider	7:0	RW	00h	POR - DAFG - LR
Enable internal PC-Beep generation. Divider == 00h disables internal PC Beep generation and enables normal operation of the codec. Divider != 00h generates the beep tone on all Pin Complexes that are currently configured as outputs. The HD Audio spec states that the beep tone frequency = (48kHz HD Audio SYNC rate) / (4*Divider), producing tones from 47 Hz to 12 kHz (logarithmic scale).				

#### 7.28.5. DigBeep (NID = 21h): Gain

Reg	Byte 4 (Bits 31:24)	Byte 3 (Bits 23:16)	Byte 2 (Bits 15:8)	Byte 1 (Bits 7:0)
Set				77Ah
Get	F7A00h			

Field Name	Bits	R/W	Default	Reset
Rsvd	31:3	R	000000h	N/A (Hard-coded)
Reserved.				
Divider	2:0	RW	05h	POR - DAFG - LR
Digital PC Beep Gain adjust in digital side 0h = -9dB, 1h = -6dB, 2h = -3dB, 3h = 0dB, 4h = +3db, 5h = +6db				



## 7.29. AdvancedFunctions (NID = 22h): WCap

Reg	Byte 4 (Bits 31:24)	Byte 3 (Bits 23:16)	Byte 2 (Bits 15:8)	Byte 1 (Bits 7:0)
Set				
Get	F0009h			

This register is reset by POR.

Field Name	Bits	R/W	Default	Reset
Rsvd2	31:24	R	00h	N/A (Hard-coded)
	Reserved.			
Type	23:20	R	Fh	N/A (Hard-coded)
	Widget type: 0h = Out Converter 1h = In Converter 2h = Summing (Mixer) 3h = Selector (Mux) 4h = Pin Complex 5h = Power 6h = Volume Knob 7h = Beep Generator 8h-Eh = Reserved Fh = Vendor Defined			
Delay	19:16	R	0h	N/A (Hard-coded)
	Number of sample delays through widget.			
Rsvd1	15:12	R	0h	N/A (Hard-coded)
	Reserved.			
SwapCap	11	R	0h	N/A (Hard-coded)
	Left/right swap support: 1 = yes, 0 = no.			
PwrCntrl	10	R	0h	N/A (Hard-coded)
	Power state support: 1 = yes, 0 = no.			
Dig	9	R	0h	N/A (Hard-coded)
	Digital stream support: 1 = yes (digital), 0 = no (analog).			
ConnList	8	R	0h	N/A (Hard-coded)
	Connection list present: 1 = yes, 0 = no.			
UnSolCap	7	R	0h	N/A (Hard-coded)
	Unsolicited response support: 1 = yes, 0 = no.			

Field Name	Bits	R/W	Default	Reset
ProcWidget	6	R	0h	N/A (Hard-coded)
	Processing state support: 1 = yes, 0 = no.			
Stripe	5	R	0h	N/A (Hard-coded)
	Striping support: 1 = yes, 0 = no.			
FormatOvrđ	4	R	0h	N/A (Hard-coded)
	Stream format override: 1 = yes, 0 = no.			
AmpParOvrđ	3	R	0h	N/A (Hard-coded)
	Amplifier capabilities override: 1 = yes, no.			
OutAmpPrsnt	2	R	0h	N/A (Hard-coded)
	Output amp present: 1 = yes, 0 = no.			
InAmpPrsnt	1	R	0h	N/A (Hard-coded)
	Input amp present: 1 = yes, 0 = no.			
Stereo	0	R	1h	N/A (Hard-coded)
	Stereo stream support: 1 = yes (stereo), 0 = no (mono).			

All registers are available when in normal mode through the HD Audio interface. Most are implemented using vendor defined verbs but some (volume controls specifically) are supported through standard verbs at the pin widgets

#### 7.29.1. AdvancedFunctions (NID = 22h): Cntrl0

Reg	Byte 4 (Bits 31:24)	Byte 3 (Bits 23:16)	Byte 2 (Bits 15:8)	Byte 1 (Bits 7:0)
Set				770h:&7AFh
Get	F7700h: 7AF0h			

This register is reset by POR.

Field Name	Bits	R/W	Default	Reset
Rsvd	31:8	R	000000h	N/A (Hard-coded)
	Reserved.			
Value	7:0	RW	0h	POR - DAFG - ULR
	Cntrl register value of module			

## 7.29.1.1. SPKVOL L/R Registers

Prior to WC revision, this register reset by POR/DAFG/ULR. WC revision, reset by POR only. Writing to NID22h verb 77F will cause reset on all silicon revisions.

Register Address	Bit	Label	Type	Default	Description
verb F71/771 (Left) verb F72/772 (Right) verb 773 (Left and Right - write only)	7:0	VOL[7:0]	RW	30	+36 to -91.5dB in 0.75dB steps 0x00 = +36dB 0x01 = +35.25dB ... 0x2F = +0.75dB 0x30 = 0dB 0x31 = -0.75dB ... 0xA9 = -90.75 0xAA to 0xFE = -91.5dB 0xFF = mute

## 7.29.1.2. PWRM Register

Prior to WC revision, this register reset by POR/DAFG/ULR. WC revision, reset by POR only. Writing to NID22h verb 77F will cause reset on all silicon revisions.

Register Address	Bit	Label	Type	Default	Description
verb F79/779	7	RSVD	RO	0	Reserved
	6	RSVD	RO	0	Reserved
	5	RSVD	RO	0	Reserved
	4	HPPWD	RW	0	Headphone ports are forced off in Aux Audio Mode (including charge pump)
	3	SPKRON	RW	0	BTL (port D) is forced on in Aux Audio Mode
	2	DMICPWD	RW	0	DMIC powered down in Aux Audio Mode (including DAC)
	1	RSVD	RW	0	Reserved
	0	RSVD	RW	0	Reserved

## 7.29.1.3. RESET Register

Register Address	Bit	Label	Type	Default	Description
verb F7F/77F	7:0	RESET	RW	0	Writing causes registers to revert to their default values (similar to a function group reset)

## 7.29.1.4. STATUS Register

Prior to WC revision, this register reset by POR/DAFG/ULR. WC revision, reset by POR only. Writing to NID22h verb 77F will cause reset on all silicon revisions

Register Address	Bit	Label	Type	Default	Description
verb F80/780	7	limit1latch	RO	0	Latched version of limit1, clear via GAINCTRL_LO[7]
	6	limit0latch	RO	0	Latched version of limit0, clear via GAINCTRL_LO[7]
	5:3	Reserved	RO	0x0	RESERVED
	2	limit1	RO	0	Set (1) if regz saturation after gain multiply for CH1. may change on a sample by sample basis.
	1	limit0	RO	0	Set (1) if regz saturation after gain multiply for CH0. may change on a sample by sample basis.
	0	zerodet_flag	RO	0	Set when input zero detect of long string of zeroes.

## 7.29.1.5. INIT Register

Prior to WC revision, this register reset by POR/DAFG/ULR. WC revision, reset by POR only. Writing to NID22h verb 77F will cause reset on all silicon revisions

Register Address	Bit	Label	Type	Default	Description
verb F81/781	7:4	Reserved	RO	0	RESERVED
	3	anabeep_dcbyb	RW	0	1 = bypass analog Beep DC filter
	2:1	anabeep_dc_coef f	RW	0x2	0: dc_coef = 24'h004000; 1: dc_coef = 24'h001000; 2: dc_coef = 24'h000400; 3: dc_coef = 24'h000100;
	0	Initialize	RW	0	1= Initialize/soft reset data path. Must be set when changing the config0 or config1 registers.

## 7.29.1.6. CONFIG Register

Prior to WC revision, this register reset by POR/DAFG/ULR. WC revision, reset by POR only. Writing to NID22h verb 77F will cause reset on all silicon revisions.

Register Address	Bit	Label	Type	Default	Description
verb F82/782	7	BPFBYBYP	RW	0	1= Bypass MonoOut band-pass filter
	6	PREBYBYP	RW	1	1= Bypass BTL EQ filter prescale
	5	EQBYBYP	RW	1	1= Bypass BTL EQ filter
	4	BTL_dcbyp	RW	0	1 = bypass BTL DC filter
	3:1	Reserved	RO	0	RESERVED
	0	HPFBYP	RW	0	1= Bypass BTL high-pass filter (not DC removal filter)

## 7.29.1.7. PWM4 Register

Prior to WC revision, this register reset by POR/DAFG/ULR. WC revision, reset by POR only. Writing to NID22h verb 77F will cause reset on all silicon revisions.

Register Address	Bit	Label	Type	Default	Description
verb F83/783	7	sc_status_clear_right	RWC	0	Write once operation will clear sc_fault_status_right
	6	sc_status_clear_left	RWC	0	Write once operation will clear sc_fault_status_left
	5	Reserved	RO	0	RESERVED
	4	sc_Fault_status_right	RO	0	1 = Fault occurs on right channel
	3	sc_Fault_status_left	RO	0	1 = Fault occurs on left channel
	2:1	scdly_set	RW	00	Used for short circuit detection; designer will set the value
	0	evenbit	RW	0	1=Noise Shaper output data are even

## 7.29.1.8. PWM3 Register

Prior to WC revision, this register reset by POR/DAFG/ULR. WC revision, reset by POR only. Writing to NID22h verb 77F will cause reset on all silicon revisions.

Register Address	Bit	Label	Type	Default	Description
verb F84/784	7:6	outctrl	RW	0	pwm output muxing 0 = normal 1 = swap 0/1 2 = ch0 on both 3 = ch1 on both
	5:0	cvalue	RW	0x2	Tristate constant value filed, must be even and not 0

## 7.29.1.9. PWM2 Register

Prior to WC revision, this register reset by POR/DAFG/ULR. WC revision, reset by POR only. Writing to NID22h verb 77F will cause reset on all silicon revisions.

Register Address	Bit	Label	Type	Default	Description
verb F85/785	7:2	dvalue	RW	0x10	dvalue constant field.
	1	pwm_outflip	RW	0	1= swap pwm a/b output pair for all channels
	0	pwm_outmode	RW	1	1= tristate, 0 = binary

## 7.29.1.10. PWM1Register

Prior to WC revision, this register reset by POR/DAFG/ULR. WC revision, reset by POR only. Writing to NID22h verb 77F will cause reset on all silicon revisions.

Register Address	Bit	Label	Type	Default	Description
verb F86/786	7	Reserved	RO	0	RESERVED
	6:2	dithpos	RW	0	Dither position, where dither inserted after NS 0,1,2 = dither bits 2:0 4 = dither bits 3:1 5 = dither bits 4:1 ... 19 = dither bits 19:17
	1	dither_range	RW	0	1= dither -1 to +1, 0 = dither -3 to +3
	0	dithclr	RW	0	1 = disable dither

## 7.29.1.11. PWM0 Register

Prior to WC revision, this register reset by POR/DAFG/ULR. WC revision, reset by POR only. Writing to NID22h verb 77F will cause reset on all silicon revisions.

Register Address	Bit	Label	Type	Default	Description
verb F87/787	7:6	PhaseOffset	RW	01	PWM ch1 offset from ch0 at 8x sample rate by: 00 = 0 degrees 01 = 90 degrees 10 = 180 degrees 11 = NA
	5	clk320mode	R	1	1 = PCA clock 320 mode 0 = PCA clock 294 mode
	4	roundup	RW	1	1= roundup, 0 = truncate for quantizer
	3	bfclr	RW	0	1 = disable binomial filter
	2	fourthorder	RW	0	1 = fourth order binomial filter, 0 = 3rd order binomial filter
	1	add3_sel	RW	0	1 = 24-bit Noise Shaper output (pre-quantizer), 0 = 8/9/10-bit quantizer output
	0	Btl_test_mode	RW	0	1 = power stage test mode

## 7.29.1.12. LMTCTRL Register

Control operation of the volume Limiter (Compressor).

Prior to WC revision, this register reset by POR/DAFG/ULR. WC revision, reset by POR only. Writing to NID22h verb 77F will cause reset on all silicon revisions.

Register Address	Bit	Label	Type	Default	Description
verb F88/788	7:4	–	RO	0	Reserved for future use.
	3	zerocross	RW	0	1 = only change limiter gain value on zero cross.
	2:1	stepsize	RW	0	Gain stepsize when incrementing or decrementing: 0 - 0.75 dB, 1 - 1.5 dB, 2 - 3.0 dB, 3 - 6.0 dB
	0	limiter_en	RW	0	1 = enable limiter (compressor)

## 7.29.1.13. LMTATKTIME (0x19), LMTHOLDTIME (0x1A), LMTRELTIME (0x1B) Registers

These 8-bit registers set the timer values between incrementing/decrementing the Compressor attenuation values. There is one register each for Attack, Hold, and Release times, the configuration parameters are the same for all three and are shown in the table below.

Prior to WC revision, these registers reset by POR/DAFG/ULR. WC revision, reset by POR only. Writing to NID22h verb 77F will cause reset on all silicon revisions..

Register Address	Bit	Label	Type	Default	Description
verb F89/789	7	ATK10ms	RW	0	1 = value in bits 6:0 is in 10ms units, otherwise 1ms units.
	6:0	LMTAT[6:0]	RW	0	Timer value in units of 1 or 10ms.

Register Address	Bit	Label	Type	Default	Description
verb F8A/78A	7	HOLD10ms	RW	0	1 = value in bits 6:0 is in 10ms units, otherwise 1ms units.
	6:0	LMTHT[6:0]	RW	0	Timer value in units of 1 or 10ms.

Register Address	Bit	Label	Type	Default	Description
verb F8B/78B	7	REL10ms	RW	0	1 = value in bits 6:0 is in 10ms units, otherwise 1ms units.
	6:0	LMTRT[6:0]	RW	0	Timer value in units of 1 or 10ms.

## 7.29.1.14. LMTATKTH (0x1D–LO, 0x1C–HI), LMTRELTH (0x1F–LO, 0x1E–HI) Registers

These 16-bit registers set the threshold values. When in attack phase and the Attack Threshold is exceeded the Compressor attenuation is incremented by stepsize (see LMTCTRL). When in release phase and the Release Threshold is not exceeded the Compressor attenuation is incremented by stepsize (but not above 0)

Prior to WC revision, these registers reset by POR/DAFG/ULR. WC revision, reset by POR only. Writing to NID22h verb 77F will cause reset on all silicon revisions..

Register Address	Bit	Label	Type	Default	Description
verb F8C/78C	7:0	LATKTH[15:8]	RW	7F	8'hFF would equal threshold level of +2.0dB. Each step below this 8-bit full scale value reduces threshold level by 0.0078 dB.

## 92HD99

### SINGLE CHIP PC AUDIO SYSTEM, CODEC+SPEAKER AMPLIFIER+CAPLESS HP+LDO

Register Address	Bit	Label	Type	Default	Description
verb F8D/78D	7:0	LATKTH[7:0]	RW	FF	Always 0. It isn't necessary to provide threshold resolution to the point where these lower 8 bits would be used.

Register Address	Bit	Label	Type	Default	Description
verb F8E/78E	7:0	LRELTH[15:8]	RW	0	8'hFF would equal threshold level of +2.0dB. Each step below this 8-bit full scale value reduces threshold level by 0.0078 dB.

Register Address	Bit	Label	Type	Default	Description
verb F8F/78F	7:0	LRELTH[7:0]	RW	0	Always 0. It isn't necessary to provide threshold resolution to the point where these lower 8 bits would be used.

#### 7.29.1.15. GAINCTRL\_HI Register

Prior to WC revision, this register reset by POR/DAFG/ULR. WC revision, reset by POR only. Writing to NID22h verb 77F will cause reset on all silicon revisions.

Register Address	Bit	Label	Type	Default	Description
verb F90/790	7:5	Reserved	RO	0	RESERVED
	4:3	zerodetlen	RW	0x2	enable mute if input consecutive zeros exceeds this length: 00 = 32 01 = 1000 10 = 2000 11 = 4000
	2:0	step_time	RW	0x5	step time units = 1<<step_time, units in GAINCTRL_LO bit 5

#### 7.29.1.16. GAINCTRL\_LO Register

Prior to WC revision, this register reset by POR/DAFG/ULR. WC revision, reset by POR only. Writing to NID22h verb 77F will cause reset on all silicon revisions.

Register Address	Bit	Label	Type	Default	Description
verb F91/791	7	clr_latch	RW	0	1 = clear limit 0/1 latches, see STATUS register
	6	RSVD	RO	0	Reserved
	5	step_10ms	RW	0	1 = units for step_time are 10ms 0 = units for step_time are 1ms
	4	stepped_change	RW	0	1 = step volume progressively to new setting
	3	disable_gain	RW	0	1 = disable all gain functions (bypass gain multiply)
	2	auto_mute	RW	1	1 = auto mute if detect long strings of zeros on input
	1	change_mode	RW	0	1 = change gain immediately 0 = change on zero cross
	0	mute_mode	RW	1	1 = hard mute after reset, 0 = soft mute



## 7.29.1.17. MUTE Register

Prior to WC revision, this register reset by POR/DAFG/ULR. WC revision, reset by POR only. Writing to NID22h verb 77F will cause reset on all silicon revisions.

Register Address	Bit	Label	Type	Default	Description
verb F92/792	7:3	Reserved	RO	0x0	RESERVED
	2	Mute	RW	0	1 = mute all channels
	1	mute1	RW	0	1 = mute ch1
	0	mute0	RW	0	1 = mute ch0

## 7.29.1.18. ATTEN Register

Prior to WC revision, this register reset by POR/DAFG/ULR. WC revision, reset by POR only. Writing to NID22h verb 77F will cause reset on all silicon revisions.

Register Address	Bit	Label	Type	Default	Description
verb F93/793	7:0	atten	RW	0x0	Attenuation. Each bit represents 0.5dB of attenuation to be applied to the channel. The range will be -125dB to 2dB as follows: 0x00: +2dB 0x01: +1.5dB 0x02: +1.0dB ... 0x47: -33.5dB 0x48: -34.0dB 0x49: -34.5dB ... 0xFE: -125dB 0xFF: Hard Master Mute

## 7.29.1.19. DC\_COEF\_SEL Register

Prior to WC revision, this register reset by POR/DAFG/ULR. WC revision, reset by POR only. Writing to NID22h verb 77F will cause reset on all silicon revisions.

Register Address	Bit	Label	Type	Default	Description
verb F94/794	7:3	Reserved	RO	0	RESERVED
	2:0	dc_coef_sel	RW	0x5	0:dc_coef = 24'h100000; //2 <sup>-3</sup> = 0.125 1:dc_coef = 24'h040000; 2:dc_coef = 24'h010000; 3:dc_coef = 24'h004000; 4:dc_coef = 24'h001000; 5:dc_coef = 24'h000400; 6:dc_coef = 24'h000100; //2 <sup>-15</sup> = 0.000330517 7:dc_coef = 24'h000040; //2 <sup>-17</sup>

## 7.29.1.20. BTL High-Pass Filter COEF\_SEL Register

Prior to WC revision, this register reset by POR/DAFG/ULR. WC revision, reset by POR only. Writing to NID22h verb 77F will cause reset on all silicon revisions.

Register Address	Bit	Label	Type	Default	Description
verb F95/795	7:3	Reserved	RO	0	RESERVED
	2:0	hp_coef_sel	RW	0x2	Select IIR coefficients for BTL amplifier high pass filter corner frequency 000 = 100Hz 001 = 200Hz <b>010 = 300Hz</b> 011 = 400Hz 100 = 500Hz 101 = 750Hz 110 = 1000Hz 111 = 2000Hz

## 7.29.1.21. BTL Class-D Power Stage Register Settings

Prior to WC revision, these registers reset by POR/DAFG/ULR. WC revision, reset by POR only. Writing to NID22h verb 77F will cause NOT generate a reset.

Register Address	Bit	Label	Type	Default	Description
verb F97/797	7	ENABLE	RW	1	1 = Enable BTL Power stage
	6	TRC_ESD	RO	0	1 = ESD trigger detected 0 = No trigger
	5	STRENDRV	RW	0	1 = Strengthen pre-drive 0 = Normal
	4:3	SCTHR	RW	01	Short circuit threshold current 00 = 10% of PVDD 01 = 14% of PVDD 10 = 16% of PVDD 11 = 20% of PVDD
	2:0	DEADTIME	RW	001	Dead time for output FETs 000 = 0.5ns 001 = 1.0ns 010 = 1.5ns 011 = 2ns 100 = 4ns 101 = 8ns 110 = 8ns 111 = 8ns

## 92HD99

### SINGLE CHIP PC AUDIO SYSTEM, CODEC+SPEAKER AMPLIFIER+CAPLESS HP+LDO

Register Address	Bit	Label	Type	Default	Description
verb F98/798	7	TEST_EN	RW	0	1 = Enable short circuit test
	6	SC_DIS	RW	0	1 = disable short circuit protection
	5	RSVD	RW	0	Reserved
	4	FAULT_SC	RO	0	1 = Fault
	3	RSVD	RW	0	Reserved
	2	PNSEL	RW	0	1=PFET tested, 0=NFET tested
	1	FORCE_SC	RW	0	1 = force short circuit
	0	TEST	RW	0	1 = Pos PFET / Neg NFET on, 0 = Pos NFET / Neg PFET on

Register Address	Bit	Label	Type	Default	Description
verb F99/799	7	ENABLE	RW	1	1 = Enable BTL Power stage
	6	TRC_ESD	RO	0	1 = ESD trigger detected 0 = No trigger
	5	STRENDRV	RW	0	1 = Strengthen pre-drive 0 = Normal
	4:3	SCTHR	RW	01	Short circuit threshold current 00 = 10% of PVDD 01 = 14% of PVDD 10 = 16% of PVDD 11 = 20% of PVDD
	2:0	DEADTIME	RW	001	Dead time for output FETs 000 = 0.5ns 001 = 1.0ns 010 = 1.5ns 011 = 2ns 100 = 4ns 101 = 8ns 110 = 8ns 111 = 8ns

Register Address	Bit	Label	Type	Default	Description
verb F9A/79A	7	TEST_EN	RW	0	1 = Enable short circuit test
	6	SC_DIS	RW	0	1 = disable short circuit protection
	5	RSVD	RW	0	Reserved
	4	FAULT_SC	RO	0	1 = Fault
	3	RSVD	RW	0	Reserved
	2	PNSEL	RW	0	1=PFET tested, 0=NFET tested
	1	FORCE_SC	RW	0	1 = force short circuit
	0	TEST	RW	0	1 = Pos PFET / Neg NFET on, 0 = Pos NFET / Neg PFET on

## 7.29.1.22. LDO LEVEL CONTROL Register

Prior to WC revision, this register reset by POR/DAFG/ULR. WC revision, reset by POR only. Writing to NID22h verb 77F will cause NOT generate a reset.

Register Address	Bit	Label	Type	Default	Description
verb F9B/79B	7:3	Reserved	RO	0x0	RESERVED
	2	Lv_QUAD_BIAS	RW	0	
	1:0	Lv_reg_cntrl_bit	RW	0x0	Two bits are defined to program the output of the 1.8V LDO 00 = normal operation (3.3V in to 1.8V out) 01 = 1.8V*1.1 = 1.98V 10 = 1.8V*0.9 = 1.62V 11 = power down LDO/bypass. When disabled, the DVDD_Core pin must be supplied with a nominal 1.8V from an external source.

## 7.29.1.23. EQRAM

The EQ RAM is a 52 x 48-bit SRAM that contains the EQ coefficients.

Prior to WC revision, this register reset by POR/DAFG/ULR. WC revision, reset by POR only OR when a BIST is run under certain conditions, contact TSI for more information. Writing to NID22h verb 77F will cause NOT generate a reset.

Address	Channel RIGHT Coefficients (24bit)	Channel LEFT Coefficients (24bit)
EQRAM Bits	[47:24]	[23:00]
based on 44.1Khz sample rate		
0x00	EQ_COEF_F0_B0	EQ_COEF_F0_B0
0x01	EQ_COEF_F0_B1	EQ_COEF_F0_B1
0x02	EQ_COEF_F0_B2	EQ_COEF_F0_B2
0x03	EQ_COEF_F0_A1	EQ_COEF_F0_A1
0x04	EQ_COEF_F0_A2	EQ_COEF_F0_A2
0x05	EQ_COEF_F1_B0	EQ_COEF_F1_B0
0x06	EQ_COEF_F1_B1	EQ_COEF_F1_B1
0x07	EQ_COEF_F1_B2	EQ_COEF_F1_B2
0x08	EQ_COEF_F1_A1	EQ_COEF_F1_A1
0x09	EQ_COEF_F1_A2	EQ_COEF_F1_A2
0x0A	EQ_COEF_F2_B0	EQ_COEF_F2_B0
0x0B	EQ_COEF_F2_B1	EQ_COEF_F2_B1
0x0C	EQ_COEF_F2_B2	EQ_COEF_F2_B2
0x0D	EQ_COEF_F2_A1	EQ_COEF_F2_A1
0x0E	EQ_COEF_F2_A2	EQ_COEF_F2_A2
0x0F	EQ_COEF_F3_B0	EQ_COEF_F3_B0
0x10	EQ_COEF_F3_B1	EQ_COEF_F3_B1
0x11	EQ_COEF_F3_B2	EQ_COEF_F3_B2
0x12	EQ_COEF_F3_A1	EQ_COEF_F3_A1
0x13	EQ_COEF_F3_A2	EQ_COEF_F3_A2

Address	Channel RIGHT Coefficients (24bit)	Channel LEFT Coefficients (24bit)
EQRAM Bits	[47:24]	[23:00]
0x14	EQ_COEF_F4_B0	EQ_COEF_F4_B0
0x15	EQ_COEF_F4_B1	EQ_COEF_F4_B1
0x16	EQ_COEF_F4_B2	EQ_COEF_F4_B2
0x17	EQ_COEF_F4_A1	EQ_COEF_F4_A1
0x18	EQ_COEF_F4_A2	EQ_COEF_F4_A2
0x19	EQ_PRESCALE	EQ_PRESCALE
based on 48Khz sample rate		
0x1A	EQ_COEF_F0_B0	EQ_COEF_F0_B0
0x1B	EQ_COEF_F0_B1	EQ_COEF_F0_B1
0x1C	EQ_COEF_F0_B2	EQ_COEF_F0_B2
0x1D	EQ_COEF_F0_A1	EQ_COEF_F0_A1
0x1E	EQ_COEF_F0_A2	EQ_COEF_F0_A2
0x1F	EQ_COEF_F1_B0	EQ_COEF_F1_B0
0x20	EQ_COEF_F1_B1	EQ_COEF_F1_B1
0x21	EQ_COEF_F1_B2	EQ_COEF_F1_B2
0x22	EQ_COEF_F1_A1	EQ_COEF_F1_A1
0x23	EQ_COEF_F1_A2	EQ_COEF_F1_A2
0x24	EQ_COEF_F2_B0	EQ_COEF_F2_B0
0x25	EQ_COEF_F2_B1	EQ_COEF_F2_B1
0x26	EQ_COEF_F2_B2	EQ_COEF_F2_B2
0x27	EQ_COEF_F2_A1	EQ_COEF_F2_A1
0x28	EQ_COEF_F2_A2	EQ_COEF_F2_A2
0x29	EQ_COEF_F3_B0	EQ_COEF_F3_B0
0x2A	EQ_COEF_F3_B1	EQ_COEF_F3_B1
0x2B	EQ_COEF_F3_B2	EQ_COEF_F3_B2
0x2C	EQ_COEF_F3_A1	EQ_COEF_F3_A1
0x2D	EQ_COEF_F3_A2	EQ_COEF_F3_A2
0x2E	EQ_COEF_F4_B0	EQ_COEF_F4_B0
0x2F	EQ_COEF_F4_B1	EQ_COEF_F4_B1
0x30	EQ_COEF_F4_B2	EQ_COEF_F4_B2
0x31	EQ_COEF_F4_A1	EQ_COEF_F4_A1
0x32	EQ_COEF_F4_A2	EQ_COEF_F4_A2
0x33	EQ_PRESCALE	EQ_PRESCALE

The EQRAM is programmed indirectly through the Control Bus in the following manner:

- 1) Write the 48-bit write data to the EQRAM\_WRITE register
- 2) Write the target address to the EQ\_ADDRESS register
- 3) Set bit 7 of the EQRAM\_CTRL register

The write will occur when the EQRAM is not being accessed by the DSP audio processing routines. When complete the hardware will automatically clear this bit.

Reading back from the EQRAM is done in the following manner:

- 1) Write target address to EQ\_ADDR register
- 2) Set bit 6 of the EQRAM\_CTRL register

When the hardware completes the read it will automatically clear this bit.

- 3) When bit 6 of the EQRAM\_CTRL register has been cleared, read the 48bit data from the EQRAM\_READ register.

## 7.29.1.24. EQRAM Read Data (0x30–0x35), EQRAM Write Data (0x36–3B) Registers

These two 48-bit registers (addressed as 12 8-bit registers) are 48-bit data holding registers used when doing indirect writes/reads to the EQRAM.

Prior to WC revision, these registers reset by POR/DAFG/ULR. WC revision, reset by POR only Writing to NID22h verb 77F will cause NOT generate a reset to EQRAMREAD registers, it will however work for EQRAMWRITE registers.]]

Register Address	Bit	Label	Type	Default	Description
EQRAM_READ[47:40] verb FA0/7A0	7:0	EQRD[47:40]	RW	0x00	48-bit data register, contains the contents of the most recent EQRAM address read from the RAM. The address read will have been specified by the EQRAM Address fields.

Register Address	Bit	Label	Type	Default	Description
EQRAM_READ[39:32] verb FA1/7A1	7:0	EQRD[39:32]	RW	0x00	48-bit data register, contains the contents of the most recent EQRAM address read from the RAM. The address read will have been specified by the EQRAM Address fields.

Register Address	Bit	Label	Type	Default	Description
EQRAM_READ[31:24] verb FA2/7A2	7:0	EQRD[31:24]	RW	0x00	48-bit data register, contains the contents of the most recent EQRAM address read from the RAM. The address read will have been specified by the EQRAM Address fields.

Register Address	Bit	Label	Type	Default	Description
EQRAM_READ[23:16] verb FA3/7A3	7:0	EQRD[23:16]	RW	0x00	48-bit data register, contains the contents of the most recent EQRAM address read from the RAM. The address read will have been specified by the EQRAM Address fields.

Register Address	Bit	Label	Type	Default	Description
EQRAM_READ[15:8] verb FA4/7A4	7:0	EQRD[15:8]	RW	0x00	48-bit data register, contains the contents of the most recent EQRAM address read from the RAM. The address read will have been specified by the EQRAM Address fields.

Register Address	Bit	Label	Type	Default	Description
EQRAM_READ[7:0] verb FA5/7A5	7:0	EQRD[7:0]	RW	0x00	48-bit data register, contains the contents of the most recent EQRAM address read from the RAM. The address read will have been specified by the EQRAM Address fields.

Register Address	Bit	Label	Type	Default	Description
EQRAM_WRITE[47:40] verb FA6/7A6	7:0	EQWD[47:40]	RW	0x00	48-bit data register, contains the values to be written to the EQRAM. The address written will have be specified by the EQRAM Address fields.

Register Address	Bit	Label	Type	Default	Description
EQRAM_WRITE[39:32] verb FA7/7A7	7:0	EQWD[39:32]	RW	0x00	48-bit data register, contains the values to be written to the EQRAM. The address written will have be specified by the EQRAM Address fields.

## 92HD99

### SINGLE CHIP PC AUDIO SYSTEM, CODEC+SPEAKER AMPLIFIER+CAPLESS HP+LDO

Register Address	Bit	Label	Type	Default	Description
EQRAM_WRITE[31:24] verb FA8/7A8	7:0	EQWD[31:24]	RW	0x00	48-bit data register, contains the values to be written to the EQRAM. The address written will have be specified by the EQRAM Address fields.

Register Address	Bit	Label	Type	Default	Description
EQRAM_WRITE[23:16] verb FA9/7A9	7:0	EQWD[23:16]	RW	0x00	48-bit data register, contains the values to be written to the EQRAM. The address written will have be specified by the EQRAM Address fields.

Register Address	Bit	Label	Type	Default	Description
EQRAM_WRITE[15:8] verb FAA/7AA	7:0	EQWD[15:8]	RW	0x00	48-bit data register, contains the values to be written to the EQRAM. The address written will have be specified by the EQRAM Address fields.

Register Address	Bit	Label	Type	Default	Description
EQRAM_WRITE[7:0] verb FAB/7AB	7:0	EQWD[7:0]	RW	0x00	48-bit data register, contains the values to be written to the EQRAM. The address written will have be specified by the EQRAM Address fields.

#### 7.29.1.25. EQRAM Address Register

This 8-bit register provides the address to the internal RAM when doing indirect writes/reads to the EQRAM.

Prior to WC revision, this register reset by POR/DAFG/ULR. WC revision, reset by POR only. Writing to NID22h verb 77F will generate a reset for all revisions.

Register Address	Bit	Label	Type	Default	Description
verb FAC/7AC	7:6	RSVD	RO	0x00	Reserved
	5:0	EQADD[5:0]	RW	0x00	Contains the address (between 0x00 and 0x33) of the EQRAM to be accessed by a read or write. This is not a byte address--it is the address of the 48-bit data item to be accessed from the EQRAM.

#### 7.29.1.26. EQRAM Control Register

This control register provides the write/read enable when doing indirect writes/reads to the EQRAM

Prior to WC revision, this register reset by POR/DAFG/ULR. WC revision, reset by POR only. Writing to NID22h verb 77F will generate a reset for all revisions.

Register Address	Bit	Label	Type	Default	Description
verb FAD/7AD	7	EQRAM_wr	RW	0	1 = write to EQRAM, cleared by HW when done
	6	EQRAM_rd	RW	0	1 = read from EQRAM, cleared by HW when done
	5:0	RSVD	RO	0	Reserved

8. PINOUT AND PACKAGING



Figure 18. 40QFN Pin Assignment



## 92HD99

### SINGLE CHIP PC AUDIO SYSTEM, CODEC+SPEAKER AMPLIFIER+CAPLESS HP+LDO

#### 8.0.1. 40QFN Pin Table

Pin Name	Pin Function	I/O	Internal Pull-up/Pull-down	40 pin location
DVDD_CORE	1.8V Digital Core Regulator Filter Cap	O(Digital)	None	1
DMIC_CLK/GPIO1	Digital Mic Clock Output/GPIO1	I/O(Digital)	60K Pull-down	2
DMIC0/GPIO2	Digital Mic 01 Input/GPIO2	I/O(Digital)	60K Pull-down	3
SDATA_OUT	HD Audio Serial Data output from controller	I/O(Digital)	None	4
BITCLK	HD Audio Bit Clock	I(Digital)	None	5
SDATA_IN	HD Audio Serial Data Input to controller	O(Digital)	None	6
DVDD	Digital Vdd= 3.3V	I(Digital)	None	7
SYNC	HD Audio Frame Sync	I(Digital)	None	8
RESET#	HD Audio Reset	I(Digital)	None	9
PCBEEP	PC Beep	I(Analog)	None	10
SENSE_A	Jack insertion detection Ports A,B,C,	I(Analog)	None	11
SENSE_B	Jack insertion detection Port F, DMIC0	I(Analog)	None	12
PORTF_L	Port F Left	I/O(Analog)	None	13
PORTF_R	Port F Right	I/O(Analog)	None	14
PORTC_L	Port C Left	I/O(Analog)	None	15
PORTC_R	Port C Right	I/O(Analog)	None	16
VREFFILT	Analog Virtual Ground	O(Analog)	None	17
CAP2	Reference filter Cap	O(Analog)	None	18
VREFOUT-A	Reference Voltage out drive (intended for mic bias)	O(Analog)	None	19
VREFOUT-C/GPIO4	Reference Voltage out drive (intended for mic bias) or general purpose I/O	I/O(Analog)	None	20
AVDD1	Analog Vdd=5.0V or 3.3V	I(Analog)	None	21
PORTA_L (HP0)	Port A Output Left	I/O(Analog)	None	22
PORTA_R (HP0)	Port A Output Right	I/O(Analog)	None	23
AVSS	Analog Ground	I(Analog)	None	24
PORTB_L (HP1)	Port B Output Left	I/O(Analog)	None	25
PORTB_R (HP1)	Port B Output Right	I/O(Analog)	None	26
AVSS	Analog Ground	I(Analog)	None	27
V-	Negative analog supply	O(Analog)	None	28
CAP-	Charge pump cap -	O(Analog)	None	29
CAP+	Charge pump cap +	O(Analog)	None	30
VREG	Linear Regulator Output (2.5V) filter cap	O(Analog)	None	31
AVDD2	Analog Supply for VREG	I(Analog)	None	32
PVDD	Analog Supply for Class-D amp	I(Analog)	None	33
PORTD_+L	BTL amp Left +	O(Analog)	None	34
PORTD_-L	BTL amp Left -	O(Analog)	None	35
PVSS	Analog Ground	I(Analog)	None	36

Table 29. 40QFN Pin Description

# 92HD99

## SINGLE CHIP PC AUDIO SYSTEM, CODEC+SPEAKER AMPLIFIER+CAPLESS HP+LDO

Pin Name	Pin Function	I/O	Internal Pull-up/Pull-down	40 pin location
PORTD_-R	BTL amp Right -	O(Analog)	None	37
PORTD_+R	BTL amp Right +	O(Analog)	None	38
PVDD	Analog Supply for Class-D amp	I(Analog)	None	39
EAPD	EAPD	I/O (Digital)	60K Pull-up	40

Table 29. 40QFN Pin Description

### 8.0.2. 40QFN Package Outline and Package Dimensions

Package dimensions are kept current with JEDEC Publication No. 95



Figure 19. 40QFN Package Diagram

8.1. Standard Reflow Profile Data

Note: These devices can be hand soldered at 360 °C for 3 to 5 seconds.

**FROM:** IPC / JEDEC J-STD-020C “Moisture/Reflow Sensitivity Classification for Nonhermetic Solid State Surface Mount Devices” ([www.jedec.org/download](http://www.jedec.org/download)).

Profile Feature	Pb Free Assembly
Average Ramp-Up Rate ( $T_{s_{max}} - T_p$ )	3 °C / second max
Preheat: Temperature Min ( $T_{s_{min}}$ ) Temperature Max ( $T_{s_{max}}$ ) Time ( $t_{s_{min}} - t_{s_{max}}$ )	150 °C 200 °C 60 - 180 seconds
Time maintained above: Temperature ( $T_L$ ) Time ( $t_L$ )	217 °C 60 - 150 seconds
Peak / Classification Temperature ( $T_p$ )	See “Package Classification Reflow Temperatures”
Time within 5 °C of actual Peak Temperature ( $t_p$ )	20 - 40 seconds
Ramp-Down rate	6 °C / second max
Time 25 °C to Peak Temperature	8 minutes max

Note: All temperatures refer to topside of the package, measured on the package body surface.

Table 30. Standard Reflow Profile



**9. DISCLAIMER**

While the information presented herein has been checked for both accuracy and reliability, manufacturer assumes no responsibility for either its use or for the infringement of any patents or other rights of third parties, which would result from its use. No other circuits, patents, or licenses are implied. This product is intended for use in normal commercial applications. Any other applications, such as those requiring extended temperature range, high reliability, or other extraordinary environmental requirements, are not recommended without additional processing by manufacturer. Manufacturer reserves the right to change any circuitry or specifications without notice. Manufacturer does not authorize or warrant any product for use in life support devices or critical medical instruments.

**10. DOCUMENT REVISION HISTORY**

Revision	Date	Description of Change
0.8	April 2010	initial release
0.85	May 2010	updated 40QFN package drawing for different DAP size.
0.86	June 2010	Aux mode section added, corrected package code in orderable part numbers
0.9	September 2010	Added changes for YA silicon revision (ZA/ZB prior settings referenced) AFG EAPD bit added for PortE Headphone control. AFG ComJack bits added to select debounce time. Removed SCS support. Updated 40QFN package diagram. Updated conditions of performance characteristics, added HDA signaling voltage to condition for power measurements. Default changed on BTL/HD_Mode from 0 to 1. Corrected Combo Jack diagram. Added Pin Configuration Default Settings.
0.91	October 2010	Updated LDO Level Control values. Corrected step size and thermal trip in BTL section. Updated SPKVOL L/R step size to .75dB. Added additional verb for updating speaker L and R volume at the same time (to match HDA implementation). Widget 22h verbs added/reordered. Added description text for High pass filter feature.
0.92	May 2011	Corrected Sense A/B description and table.
0.93	June 2011	Corrected front page bullet for BTL voltage and corrected table 1 pin numbers for BTL.
1.0	October 2011	Corrected Left vs Right channel for the EQ coefficients to match silicon. Updated electrical characteristics for typical values. Removed Preliminary. Removed comments related to ZA and ZB silicon since they were non-production. Added WB silicon widget items: ComboJackTiming in the AFG and ScStableTimeSel added to AFG AnaBTL. Added PVDD value for the digital maximum supply voltage and footnote to the GPIO characteristics for the Input Low and High Voltage.
1.1	November 2011	Added feature bullet and description section for microphone input mute which is available only on silicon revisions WB and beyond.
1.2	January 2012	Corrections for 022FB0 / 0227B0 to 022FB6 / 0227B6 as they are not reachable via NID22 but must be accessed through the Port Nodes. Updated NID22 registers with reset information, which is different for WC silicon revision.
1.3	March 2012	Added ComboJackTime widget and EAPD widget details.
1.4	June 2012	Added THD+N setting to Class D Output power and 3W typical line.
1.5	February 2013	Added Industrial temp package option for revisions WC and beyond. Correct 40QFN Tcase.
1.6	Septmeber 2014	Released in TSI format

**92HD99**

**SINGLE CHIP PC AUDIO SYSTEM, CODEC+SPEAKER AMPLIFIER+CAPLESS HP+LDO**

---



[www.temposemi.com](http://www.temposemi.com)  
8627 N. MoPac Expwy Suite 130  
Austin, Texas 78759

DISCLAIMER Tempo Semiconductor, Inc. (TSI) and its subsidiaries reserve the right to modify the products and/or specifications described herein at any time and at TSI's sole discretion. All information in this document, including descriptions of product features and performance, is subject to change without notice. Performance specifications and the operating parameters of the described products are determined in the independent state and are not guaranteed to perform the same way when installed in customer products. The information contained herein is provided without representation or warranty of any kind, whether express or implied, including, but not limited to, the suitability of TSI's products for any particular purpose, an implied warranty of merchantability, or non-infringement of the intellectual property rights of others. This document is presented only as a guide and does not convey any license under intellectual property rights of TSI or any third parties.

TSI's products are not intended for use in life support systems or similar devices where the failure or malfunction of an TSI product can be reasonably expected to significantly affect the health or safety of users. Anyone using an TSI product in such a manner does so at their own risk, absent an express, written agreement by TSI.

Tempo Semiconductor, TSI and the TSI logo are registered trademarks of TSI. Other trademarks and service marks used herein, including protected names, logos and designs, are the property of TSI or their respective third party owners.

Copyright 2014. All rights reserved.



Компания «ЭлектроПласт» предлагает заключение долгосрочных отношений при поставках импортных электронных компонентов на взаимовыгодных условиях!

Наши преимущества:

- Оперативные поставки широкого спектра электронных компонентов отечественного и импортного производства напрямую от производителей и с крупнейших мировых складов;
- Поставка более 17-ти миллионов наименований электронных компонентов;
- Поставка сложных, дефицитных, либо снятых с производства позиций;
- Оперативные сроки поставки под заказ (от 5 рабочих дней);
- Экспресс доставка в любую точку России;
- Техническая поддержка проекта, помощь в подборе аналогов, поставка прототипов;
- Система менеджмента качества сертифицирована по Международному стандарту ISO 9001;
- Лицензия ФСБ на осуществление работ с использованием сведений, составляющих государственную тайну;
- Поставка специализированных компонентов (Xilinx, Altera, Analog Devices, Intersil, Interpoint, Microsemi, Aeroflex, Peregrine, Syfer, Eurofarad, Texas Instrument, Miteq, Cobham, E2V, MA-COM, Hittite, Mini-Circuits, General Dynamics и др.);

Помимо этого, одним из направлений компании «ЭлектроПласт» является направление «Источники питания». Мы предлагаем Вам помощь Конструкторского отдела:

- Подбор оптимального решения, техническое обоснование при выборе компонента;
- Подбор аналогов;
- Консультации по применению компонента;
- Поставка образцов и прототипов;
- Техническая поддержка проекта;
- Защита от снятия компонента с производства.



#### Как с нами связаться

**Телефон:** 8 (812) 309 58 32 (многоканальный)

**Факс:** 8 (812) 320-02-42

**Электронная почта:** [org@eplast1.ru](mailto:org@eplast1.ru)

**Адрес:** 198099, г. Санкт-Петербург, ул. Калинина, дом 2, корпус 4, литера А.