

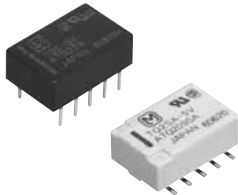

**5 mm Low profile,
2 Form C and 2 A (surface-
mount type) relays**

TQ RELAYS



RoHS compliant

FEATURES

- 1. Flat compact size**
14.0 (L) × 9.0 (W) × 5.0 (H) mm
.551 (L) × .354 (W) × .197 (H) inch
- 2. Nominal operating power:
High sensitivity of 140mW (2 Form C single side stable type)**
- 3. Suitable for SMD automatic insertion (SA type)**
With a height of 5.6 mm .220 inch, the relays meet JIS C 0806 specifications.
- 4. DIL terminal array enables use of IC sockets**
- 5. Low thermal electromotive force (approx. 5 μV)
[approx. 2 μV (surface-mount type)]**
- 6. Latching types also available**
- 7. Self-clinching terminal also available**

- 8. A range of surface-mount types is also available**
SA: Low-profile surface-mount terminal type
SL: High connection reliability surface-mount terminal type
SS: Space saving surface-mount terminal type
- 9. M.B.B. contact types available**

TYPICAL APPLICATIONS

1. Telephone-related equipment
2. Communications
3. Measurement equipment
4. OA equipment
5. Industrial machines

ORDERING INFORMATION

TQ **2** - - - - -

Contact arrangement
2: 2 Form C

Terminal shape
Nil: Standard PC board terminal
H: Self-clinching terminal
SA: SA type
SL: SL type
SS: SS type

Operating function
Nil: Single side stable
L: 1 coil latching
L2: 2 coil latching

MBB function
Nil: Standard (B.B.M.) type
2M: 2M.B.B. type

Nominal coil voltage (DC)*
1.5 (SMD only), 3, 4.5, 5, 6, 9, 12, 24, 48V

Packing style
Nil: Tube packing
X: Tape and reel (picked from 1/2/3/4/5-pin side)
Z: Tape and reel packing (picked from the 6/7/8/9/10-pin side)

Notes: 1. *48 V coil type: Single side stable only
2. In case of 5 V transistor drive circuit, it is recommended to use 4.5 V type relay.

TYPES

■ Standard PC board terminal and self-clinching terminal

1. Standard (B.B.M.) type

1) Standard PC board terminal

| Contact arrangement | Nominal coil voltage | Single side stable | 1 coil latching | 2 coil latching |
|---------------------|----------------------|--------------------|-----------------|-----------------|
| | | Part No. | Part No. | Part No. |
| 2 Form C | 3 V DC | TQ2-3V | TQ2-L-3V | TQ2-L2-3V |
| | 4.5 V DC | TQ2-4.5V | TQ2-L-4.5V | TQ2-L2-4.5V |
| | 5 V DC | TQ2-5V | TQ2-L-5V | TQ2-L2-5V |
| | 6 V DC | TQ2-6V | TQ2-L-6V | TQ2-L2-6V |
| | 9 V DC | TQ2-9V | TQ2-L-9V | TQ2-L2-9V |
| | 12 V DC | TQ2-12V | TQ2-L-12V | TQ2-L2-12V |
| | 24 V DC | TQ2-24V | TQ2-L-24V | TQ2-L2-24V |
| | 48 V DC | TQ2-48V | — | — |

Standard packing (2 Form C): Tube: 50 pcs.; Case: 1,000 pcs.

2) Self-clinching terminal

| Contact arrangement | Nominal coil voltage | Single side stable | 1 coil latching | 2 coil latching |
|---------------------|----------------------|--------------------|-----------------|-----------------|
| | | Part No. | Part No. | Part No. |
| 2 Form C | 3 V DC | TQ2H-3V | TQ2H-L-3V | TQ2H-L2-3V |
| | 4.5 V DC | TQ2H-4.5V | TQ2H-L-4.5V | TQ2H-L2-4.5V |
| | 5 V DC | TQ2H-5V | TQ2H-L-5V | TQ2H-L2-5V |
| | 6 V DC | TQ2H-6V | TQ2H-L-6V | TQ2H-L2-6V |
| | 9 V DC | TQ2H-9V | TQ2H-L-9V | TQ2H-L2-9V |
| | 12 V DC | TQ2H-12V | TQ2H-L-12V | TQ2H-L2-12V |
| | 24 V DC | TQ2H-24V | TQ2H-L-24V | TQ2H-L2-24V |
| | 48 V DC | TQ2H-48V | — | — |

Note: Types ("*-3" to the end of part No.) designed to withstand strong vibration caused, for example, by the use of terminal cutters, can also be ordered. However, please contact us if you need parts for use in low level load.

2. M.B.B. type

1) Standard PC board terminal

| Contact arrangement | Nominal coil voltage | Single side stable |
|---------------------|----------------------|--------------------|
| | | Part No. |
| 2 Form C | 3 V DC | TQ2-2M-3V |
| | 4.5 V DC | TQ2-2M-4.5V |
| | 5 V DC | TQ2-2M-5V |
| | 6 V DC | TQ2-2M-6V |
| | 9 V DC | TQ2-2M-9V |
| | 12 V DC | TQ2-2M-12V |
| | 24 V DC | TQ2-2M-24V |

Standard packing: Tube: 50 pcs.; Case: 1,000 pcs.

2) Self-clinching terminal

| Contact arrangement | Nominal coil voltage | Single side stable |
|---------------------|----------------------|--------------------|
| | | Part No. |
| 2 Form C | 3 V DC | TQ2H-2M-3V |
| | 4.5 V DC | TQ2H-2M-4.5V |
| | 5 V DC | TQ2H-2M-5V |
| | 6 V DC | TQ2H-2M-6V |
| | 9 V DC | TQ2H-2M-9V |
| | 12 V DC | TQ2H-2M-12V |
| | 24 V DC | TQ2H-2M-24V |

Standard packing: Tube: 50 pcs.; Case: 1,000 pcs.

Notes: 1. Latching types are available by request. Please consult us for details.

2. UL/CSA approved (UL file No.:E 43149, CSA file No.: LR26550)

3. Types ("*-1" to the end of part No.) designed to withstand strong vibration caused, for example, by the use of terminal cutters, can also be ordered. However, please contact us if you need parts for use in low level load and low thermal power.

■ Surface-mount terminal

1) Tube packing

| Contact arrangement | Nominal coil voltage | Single side stable | 1 coil latching | 2 coil latching |
|---------------------|----------------------|--------------------|-----------------|-----------------|
| | | Part No. | Part No. | Part No. |
| 2c | 1.5 V DC | TQ2S□-1.5V | TQ2S□-L-1.5V | TQ2S□-L2-1.5V |
| | 3 V DC | TQ2S□-3V | TQ2S□-L-3V | TQ2S□-L2-3V |
| | 4.5 V DC | TQ2S□-4.5V | TQ2S□-L-4.5V | TQ2S□-L2-4.5V |
| | 5 V DC | TQ2S□-5V | TQ2S□-L-5V | TQ2S□-L2-5V |
| | 6 V DC | TQ2S□-6V | TQ2S□-L-6V | TQ2S□-L2-6V |
| | 9 V DC | TQ2S□-9V | TQ2S□-L-9V | TQ2S□-L2-9V |
| | 12 V DC | TQ2S□-12V | TQ2S□-L-12V | TQ2S□-L2-12V |
| | 24 V DC | TQ2S□-24V | TQ2S□-L-24V | TQ2S□-L2-24V |
| | 48 V DC | TQ2S□-48V | — | — |

□: For each surface-mounted terminal identification, input the following letter. SA type: A, SL type: L, SS type: S
Standard packing: Tube: 50 pcs.; Case: 1,000 pcs.

2) Tape and reel packing

| Contact arrangement | Nominal coil voltage | Single side stable | 1 coil latching | 2 coil latching |
|---------------------|----------------------|--------------------|-----------------|-----------------|
| | | Part No. | Part No. | Part No. |
| 2 Form C | 1.5 V DC | TQ2S□-1.5V-Z | TQ2S□-L-1.5V-Z | TQ2S□-L2-1.5V-Z |
| | 3 V DC | TQ2S□-3V-Z | TQ2S□-L-3V-Z | TQ2S□-L2-3V-Z |
| | 4.5 V DC | TQ2S□-4.5V-Z | TQ2S□-L-4.5V-Z | TQ2S□-L2-4.5V-Z |
| | 5 V DC | TQ2S□-5V-Z | TQ2S□-L-5V-Z | TQ2S□-L2-5V-Z |
| | 6 V DC | TQ2S□-6V-Z | TQ2S□-L-6V-Z | TQ2S□-L2-6V-Z |
| | 9 V DC | TQ2S□-9V-Z | TQ2S□-L-9V-Z | TQ2S□-L2-9V-Z |
| | 12 V DC | TQ2S□-12V-Z | TQ2S□-L-12V-Z | TQ2S□-L2-12V-Z |
| | 24 V DC | TQ2S□-24V-Z | TQ2S□-L-24V-Z | TQ2S□-L2-24V-Z |
| | 48 V DC | TQ2S□-48V-Z | — | — |

□: For each surface-mounted terminal identification, input the following letter. SA type: A, SL type: L, SS type: S
Standard packing: Tape and reel: 500 pcs.; Case: 1,000 pcs.

Note: Tape and reel packing symbol "-Z" is not marked on the relay. "X" type tape and reel packing (picked from 1/2/3/4-pin side) is also available.

RATING

■ Standard PC board terminal and self-clinching terminal

1. Coil data

[Standard (B.B.M.) type]

1) Single side stable (2 Form C)

| Nominal coil voltage | Pick-up voltage (at 20°C 68°F) | Drop-out voltage (at 20°C 68°F) | Nominal operating current [±10%] (at 20°C 68°F) | Coil resistance [±10%] (at 20°C 68°F) | Nominal operating power | Max. applied voltage (at 20°C 68°F) |
|----------------------|--|--|---|---------------------------------------|-------------------------|-------------------------------------|
| 3 V DC | 75%V or less of nominal voltage* (Initial) | 10%V or more of nominal voltage* (Initial) | 46.7 mA | 64.3 Ω | 140 mW | 150%V of nominal voltage |
| 4.5 V DC | | | 31.1 mA | 144.6 Ω | | |
| 5 V DC | | | 28.1 mA | 178 Ω | | |
| 6 V DC | | | 23.3 mA | 257 Ω | | |
| 9 V DC | | | 15.5 mA | 579 Ω | | |
| 12 V DC | | | 11.7 mA | 1,028 Ω | | |
| 24 V DC | | | 8.3 mA | 2,880 Ω | 200 mW | |
| 48 V DC | | | 6.25 mA | 7,680 Ω | 300 mW | 120%V of nominal voltage |

2) 1 coil latching (2 Form C)

| Nominal coil voltage | Set voltage (at 20°C 68°F) | Reset voltage (at 20°C 68°F) | Nominal operating current [±10%] (at 20°C 68°F) | Coil resistance [±10%] (at 20°C 68°F) | Nominal operating power | Max. applied voltage (at 20°C 68°F) |
|----------------------|--|--|---|---------------------------------------|-------------------------|-------------------------------------|
| 3 V DC | 75%V or less of nominal voltage* (Initial) | 75%V or less of nominal voltage* (Initial) | 33.3 mA | 90 Ω | 100 mW | 150%V of nominal voltage |
| 4.5 V DC | | | 22.2 mA | 202.5 Ω | | |
| 5 V DC | | | 20 mA | 250 Ω | | |
| 6 V DC | | | 16.7 mA | 360 Ω | | |
| 9 V DC | | | 11.1 mA | 810 Ω | | |
| 12 V DC | | | 8.3 mA | 1,440 Ω | | |
| 24 V DC | | | 6.3 mA | 3,840 Ω | 150 mW | |

3) 2 coil latching (2 Form C)

| Nominal coil voltage | Set voltage (at 20°C 68°F) | Reset voltage (at 20°C 68°F) | Nominal operating current [±10%] (at 20°C 68°F) | | Coil resistance [±10%] (at 20°C 68°F) | | Nominal operating power | | Max. applied voltage (at 20°C 68°F) |
|----------------------|--|--|---|------------|---------------------------------------|------------|-------------------------|------------|-------------------------------------|
| | | | Set coil | Reset coil | Set coil | Reset coil | Set coil | Reset coil | |
| 3 V DC | 75%V or less of nominal voltage* (Initial) | 75%V or less of nominal voltage* (Initial) | 66.7 mA | 66.7 mA | 45 Ω | 45 Ω | 200 mW | 200 mW | 150%V of nominal voltage |
| 4.5 V DC | | | 44.4 mA | 44.4 mA | 101.2 Ω | 101.2 Ω | | | |
| 5 V DC | | | 40 mA | 40 mA | 125 Ω | 125 Ω | | | |
| 6 V DC | | | 33.3 mA | 33.3 mA | 180 Ω | 180 Ω | | | |
| 9 V DC | | | 22.2 mA | 22.2 mA | 405 Ω | 405 Ω | | | |
| 12 V DC | | | 16.7 mA | 16.7 mA | 720 Ω | 720 Ω | | | |
| 24 V DC | | | 12.5 mA | 12.5 mA | 1,920 Ω | 1,920 Ω | 300 mW | 300 mW | 120%V of nominal voltage |

[M.B.B. type]

| Nominal coil voltage | Pick-up voltage (at 20°C 68°F) | Drop-out voltage (at 20°C 68°F) | Nominal operating current [±10%] (at 20°C 68°F) | | Coil resistance [±10%] (at 20°C 68°F) | | Nominal operating power | Max. applied voltage (at 20°C 68°F) |
|----------------------|--|--|---|------------|---------------------------------------|------------|-------------------------|-------------------------------------|
| | | | Set coil | Reset coil | Set coil | Reset coil | | |
| 3 V DC | 80%V or less of nominal voltage* (Initial) | 10%V or more of nominal voltage* (Initial) | 66.7 mA | | 45 Ω | | 200 mW | 150%V of nominal voltage |
| 4.5 V DC | | | 44.4 mA | | 101 Ω | | | |
| 5 V DC | | | 40 mA | | 125 Ω | | | |
| 6 V DC | | | 33.3 mA | | 180 Ω | | | |
| 9 V DC | | | 22.2 mA | | 405 Ω | | | |
| 12 V DC | | | 16.7 mA | | 720 Ω | | | |
| 24 V DC | | | 8.3 mA | | 2,880 Ω | | | |

*Pulse drive (JIS C 5442-1986)

2. Specifications

| Characteristics | Item | Specifications | |
|--|--|--|---|
| Contact | Arrangement | 2 Form C, 2 Form D (M.B.B.) | |
| | Initial contact resistance, max. | Max. 50mΩ (By voltage drop 6 V DC 1A) | |
| | Contact material | Ag+Au clad | |
| Rating | Nominal switching capacity | 1 A 30 V DC, 0.5 A 125 V AC (resistive load) | |
| | Max. switching power | 30 W (DC), 62.5 V A (AC) (resistive load) | |
| | Max. switching voltage | 110 V DC, 125 V AC | |
| | Max. switching current | 1 A | |
| | Min. switching capacity (Reference value)** | 10μA 10mV DC | |
| | Nominal operating power | Single side stable 1 coil latching 2 coil latching | Standard (B.B.M) type: 140 mW (3 to 12 V DC), 200 mW (24 V DC), 300 mW (48 V DC) M.B.B. type: 200 mW 100 mW (3 to 12 V DC), 150 mW (24 V DC) 200 mW (3 to 12 V DC), 300 mW (24 V DC) |
| Electrical characteristics | Insulation resistance (Initial) | Min. 1,000MΩ (at 500V DC) Measurement at same location as "Initial breakdown voltage" section. | |
| | Breakdown voltage (Initial) | Between open contacts | Standard (B.B.M) type: 750 Vrms for 1min. (Detection current: 10 mA), M.B.B. type: 300 Vrms for 1 min. (Detection current: 10 mA) |
| | | Between contact and coil | 1,000 Vrms for 1min. (Detection current: 10 mA) |
| | | Between contact sets | 1,000 Vrms for 1min. (Detection current: 10 mA) |
| | Temperature rise (at 20°C 68°F) | Max. 50°C (By resistive method, nominal coil voltage applied to the coil; contact carrying current: 1A.) | |
| | Operate time [Set time] (at 20°C 68°F) | Max. 3 ms [Max. 3 ms] (Nominal coil voltage applied to the coil, excluding contact bounce time.) | |
| Release time [Reset time] (at 20°C 68°F) | Max. 3 ms [Max. 3 ms] (Nominal coil voltage applied to the coil, excluding contact bounce time.) (without diode) | | |
| Mechanical characteristics | Shock resistance | Functional | Min. 490 m/s ² (Half-wave pulse of sine wave: 11 ms; detection time: 10μs.) |
| | | Destructive | Min. 980 m/s ² (Half-wave pulse of sine wave: 6 ms.) |
| | Vibration resistance | Functional | 10 to 55 Hz at double amplitude of 3 mm (Detection time: 10μs.) |
| Destructive | | 10 to 55 Hz at double amplitude of 5 mm | |
| Expected life | Mechanical (at 180 cpm) | Standard (B.B.M) type: Min. 10 ⁸ , M.B.B. type: Min. 10 ⁷ | |
| | Electrical (at 20 cpm) | Standard (B.B.M) type: Min. 2×10 ⁵ (1 A 30 V DC resistive), Min. 10 ⁵ (0.5 A 125 V AC resistive) M.B.B. type: Min. 10 ⁵ (1 A 30 V DC resistive) | |
| Conditions | Conditions for operation, transport and storage** | Standard (B.B.M) type: Ambient temperature: -40°C to +70°C -40°F to +158°F; Humidity: 5 to 85% R.H. (Not freezing and condensing at low temperature) M.B.B. type: Ambient temperature: -40°C to +50°C -40°F to +122°F; Humidity: 5 to 85% R.H. (Not freezing and condensing at low temperature) | |
| | Max. operating speed (at rated load) | 20 cpm | |
| Unit weight | | Approx. 1.5 g .053 oz | |

Notes: *1 This value can change due to the switching frequency, environmental conditions, and desired reliability level, therefore it is recommended to check this with the actual load. TX/TX-S/TX-D relay AgPd contact type are available for low level load switching (10V DC, 10mA max. level).

*2 Refer to "AMBIENT ENVIRONMENT" in GENERAL APPLICATION GUIDELINES.

■ Surface-mount terminal

1. Coil data

1) Single side stable

| Nominal coil voltage | Pick-up voltage (at 20°C 68°F) | Drop-out voltage (at 20°C 68°F) | Nominal operating current (at 20°C 68°F) | Coil resistance [±10%] (at 20°C 68°F) | Nominal operating power | Max. applied voltage (at 20°C 68°F) |
|----------------------|--|--|--|---------------------------------------|-------------------------|-------------------------------------|
| 1.5 V DC | 75%V or less of nominal voltage* (Initial) | 10%V or more of nominal voltage* (Initial) | 93.8 mA | 16 Ω | 140 mW | 150%V of nominal voltage |
| 3 V DC | | | 46.7 mA | 64.3 Ω | | |
| 4.5 V DC | | | 31 mA | 145 Ω | | |
| 5 V DC | | | 28.1 mA | 178 Ω | | |
| 6 V DC | | | 23.3 mA | 257 Ω | | |
| 9 V DC | | | 15.5 mA | 579 Ω | | |
| 12 V DC | | | 11.7 mA | 1,028 Ω | 200 mW | |
| 24 V DC | | | 8.3 mA | 2,880 Ω | | |
| 48 V DC | | | | | 6.3 mA | 7,680 Ω |

2) 1 coil latching

| Nominal coil voltage | Set voltage (at 20°C 68°F) | Reset voltage (at 20°C 68°F) | Nominal operating current (at 20°C 68°F) | Coil resistance [±10%] (at 20°C 68°F) | Nominal operating power | Max. applied voltage (at 20°C 68°F) |
|----------------------|--|--|--|---------------------------------------|-------------------------|-------------------------------------|
| 1.5 V DC | 75%V or less of nominal voltage* (Initial) | 75%V or less of nominal voltage* (Initial) | 46.9 mA | 32 Ω | 70 mW | 150%V of nominal voltage |
| 3 V DC | | | 23.3 mA | 128.6 Ω | | |
| 4.5 V DC | | | 15.6 mA | 289.3 Ω | | |
| 5 V DC | | | 14 mA | 357 Ω | | |
| 6 V DC | | | 11.7 mA | 514 Ω | | |
| 9 V DC | | | 7.8 mA | 1,157 Ω | | |
| 12 V DC | | | 5.8 mA | 2,057 Ω | 100 mW | |
| 24 V DC | | | 4.2 mA | 5,760 Ω | | |

3) 2 coil latching

| Nominal coil voltage | Set voltage (at 20°C 68°F) | Reset voltage (at 20°C 68°F) | Nominal operating current (at 20°C 68°F) | | Coil resistance [±10%] (at 20°C 68°F) | | Nominal operating power | | Max. applied voltage (at 20°C 68°F) |
|----------------------|--|--|--|------------|---------------------------------------|------------|-------------------------|------------|-------------------------------------|
| | | | Set coil | Reset coil | Set coil | Reset coil | Set coil | Reset coil | |
| 1.5 V DC | 75%V or less of nominal voltage* (Initial) | 75%V or less of nominal voltage* (Initial) | 93.8 mA | 93.8 mA | 16 Ω | 16 Ω | 140 mW | 140 mW | 150%V of nominal voltage |
| 3 V DC | | | 46.7 mA | 46.7 mA | 64.3 Ω | 64.3 Ω | | | |
| 4.5 V DC | | | 31 mA | 31 mA | 145 Ω | 145 Ω | | | |
| 5 V DC | | | 28.1 mA | 28.1 mA | 178 Ω | 178 Ω | | | |
| 6 V DC | | | 23.3 mA | 23.3 mA | 257 Ω | 257 Ω | | | |
| 9 V DC | | | 15.5 mA | 15.5 mA | 579 Ω | 579 Ω | | | |
| 12 V DC | | | 11.7 mA | 11.7 mA | 1,028 Ω | 1,028 Ω | 200 mW | 200 mW | |
| 24 V DC | | | 8.3 mA | 8.3 mA | 2,880 Ω | 2,880 Ω | | | |

*Pulse drive (JIS C 5442-1986)

2. Specifications

| Characteristics | Item | Specifications | |
|--|--|---|---|
| Contact | Arrangement | 2 Form C | |
| | Initial contact resistance, max. | Max. 75 mΩ (By voltage drop 6 V DC 1A) | |
| | Contact material | AgNi type+Au clad | |
| Rating | Nominal switching capacity | 2 A 30 V DC, 0.5 A 125 V AC (resistive load) | |
| | Max. switching power | 60 W (DC), 62.5 VA (AC) (resistive load) | |
| | Max. switching voltage | 220 V DC, 125 V AC | |
| | Max. switching current | 2 A | |
| | Min. switching capacity (Reference value)*1 | 10μA 10mV DC | |
| | Nominal operating power | Single side stable | 140 mW (1.5 to 12 V DC), 200 mW (24 V DC), 300 mW (48 V DC) |
| | | 1 coil latching | 70 mW (1.5 to 12 V DC), 100 mW (24 V DC) |
| 2 coil latching | | 140 mW (1.5 to 12 V DC), 200 mW (24 V DC) | |
| Electrical characteristics | Insulation resistance (Initial) | Min. 1,000MΩ (at 500V DC) Measurement at same location as "Initial breakdown voltage" section. | |
| | Breakdown voltage (Initial) | Between open contacts | 1,000 Vrms for 1 min. (Detection current: 10 mA) |
| | | Between contact and coil | 1,500 Vrms for 1 min. (Detection current: 10 mA) |
| | | Between contact sets | 1,500 Vrms for 1 min. (Detection current: 10 mA) |
| | Surge breakdown voltage (Initial) | Between open contacts | 1,500 V (10×160μs) (FCC Part 68) |
| | | Between contacts and coil | 2,500 V (2×10μs) (Bellcore) |
| | Temperature rise (at 20°C 68°F) | Max. 50°C (By resistive method, nominal coil voltage applied to the coil; contact carrying current: 2A.) | |
| | Operate time [Set time] (at 20°C 68°F) | Max. 4 ms [Max. 4 ms] (Nominal coil voltage applied to the coil, excluding contact bounce time.) | |
| Release time [Reset time] (at 20°C 68°F) | Max. 4 ms [Max. 4 ms] (Nominal coil voltage applied to the coil, excluding contact bounce time.) (without diode) | | |
| Mechanical characteristics | Shock resistance | Functional | Min. 750 m/s ² (Half-wave pulse of sine wave: 6 ms; detection time: 10μs.) |
| | | Destructive | Min. 1,000 m/s ² (Half-wave pulse of sine wave: 6 ms.) |
| | Vibration resistance | Functional | 10 to 55 Hz at double amplitude of 3.3 mm (Detection time: 10μs.) |
| | | Destructive | 10 to 55 Hz at double amplitude of 5 mm |
| Expected life | Mechanical | Min. 10 ⁸ (at 180 cpm) | |
| | Electrical | Min. 10 ⁵ (2 A 30 V DC resistive), Min. 2×10 ⁵ (1 A 30 V DC resistive), Min. 10 ⁵ (0.5 A 125 V AC resistive) (at 20 cpm) | |
| Conditions | Conditions for operation, transport and storage*2 | Ambient temperature: -40°C to +85°C -40°F to +185°F, Max. -40°C to +70°C (2A) Max. -40°F to +158°F (2A); Humidity: 5 to 85% R.H. (Not freezing and condensing at low temperature) | |
| | Max. operating speed (at rated load) | 20 cpm | |
| Unit weight | | Approx. 2 g .071 oz | |

Notes: *1 This value can change due to the switching frequency, environmental conditions, and desired reliability level, therefore it is recommended to check this with the actual load. (TX/TX-S/TX-D relay AgPd contact type are available for low level load switching [10V DC, 10mA max. level])

*2 Refer to "AMBIENT ENVIRONMENT" in GENERAL APPLICATION GUIDELINES.

REFERENCE DATA

Standard PC board terminal and self-clinching terminal

1. Maximum switching capacity



2. Life curve



3. Mechanical life

Tested sample: TQ2-12V, 10 pcs.



4.-(1) Electrical life (DC load)

Tested sample: TQ2-12V, 6 pcs.
Condition: 1 A 30 V DC resistive load, 20 cpm
Change of pick-up and drop-out voltage

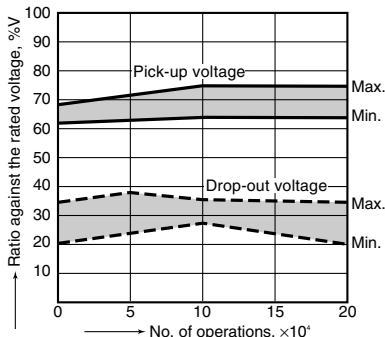

Change of contact resistance

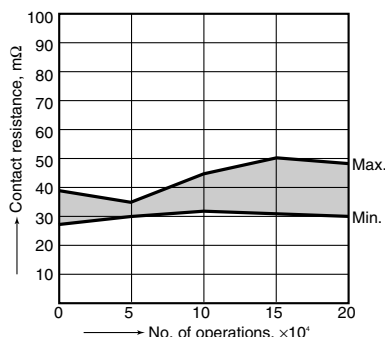

4.-(2) Electrical life (AC load)

Tested sample: TQ2-12V, 6 pcs.
Condition: 0.5 A 125 V AC resistive load, 20 cpm
Change of pick-up and drop-out voltage

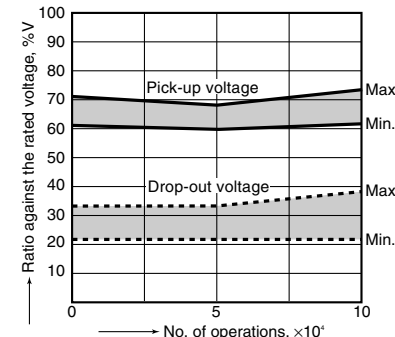

5. Coil temperature rise (2C)

Tested sample: TQ2-12V
Measured portion: Inside the coil
Ambient temperature: 30°C 86°F

Change of contact resistance

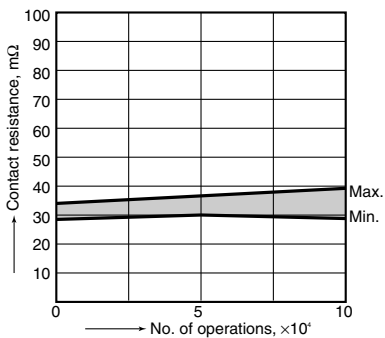

5. Coil temperature rise (2C)

Tested sample: TQ2-12V
Measured portion: Inside the coil
Ambient temperature: 30°C 86°F

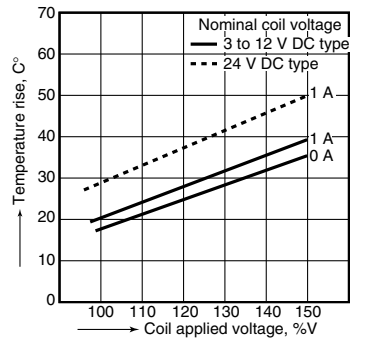

6. Ambient temperature characteristics

Tested sample: TQ2-12V, 5 pcs.

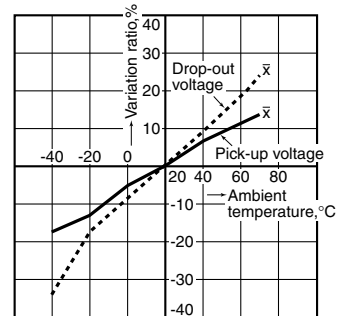

7.-(1) High-frequency characteristics (Isolation)

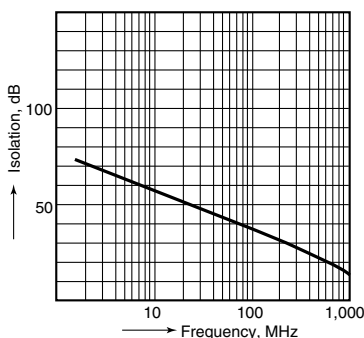

7.-(2) High-frequency characteristics (Insertion loss)

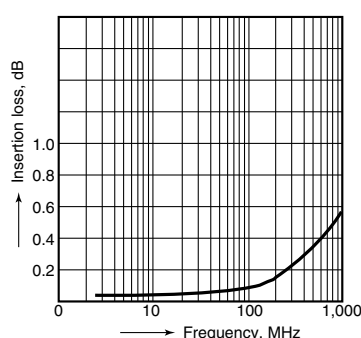

8. Malfunctional shock (single side stable)

Tested sample: TQ2-12V, 6 pcs.

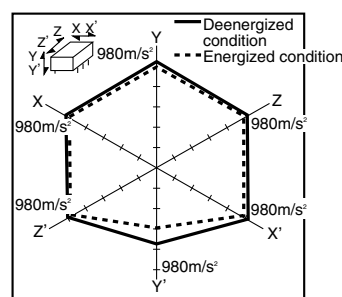

9.-(1) Influence of adjacent mounting

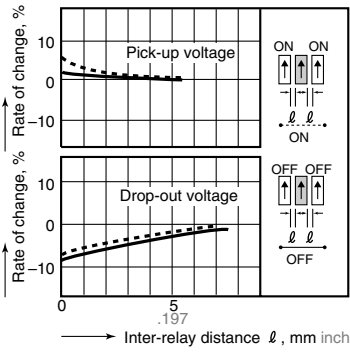

9.-(2) Influence of adjacent mounting



10. Contact reliability
(1 mA 5 V DC resistive load)
Tested sample: TQ2-12V
Condition: Detection level 10 W

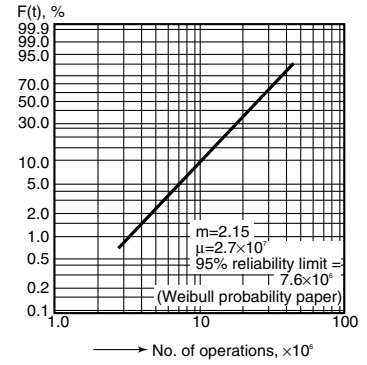

11. Actual load test (35 mA 48 V DC wire spring relay load)

Circuit

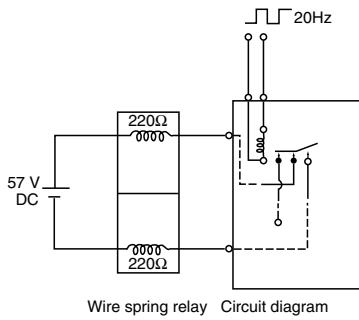

Change of pick-up and drop-out voltage

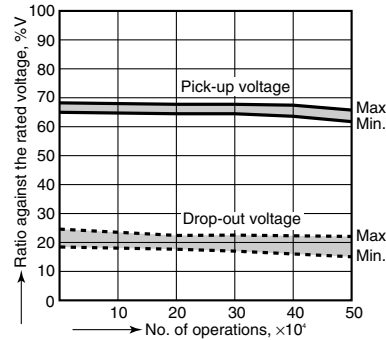

Change of contact resistance

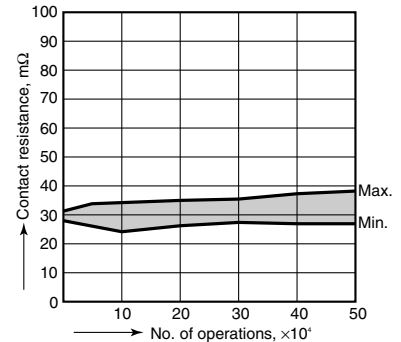

12. 0.1 A 53 V DC resistive load test

Change of pick-up and drop-out voltage

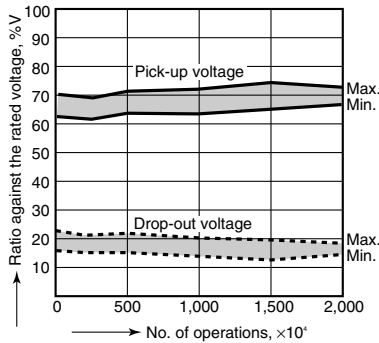

Change of contact resistance



13. Distribution of M.B.B. time

Tested sample: TQ2-2M-5V, 85 pcs.

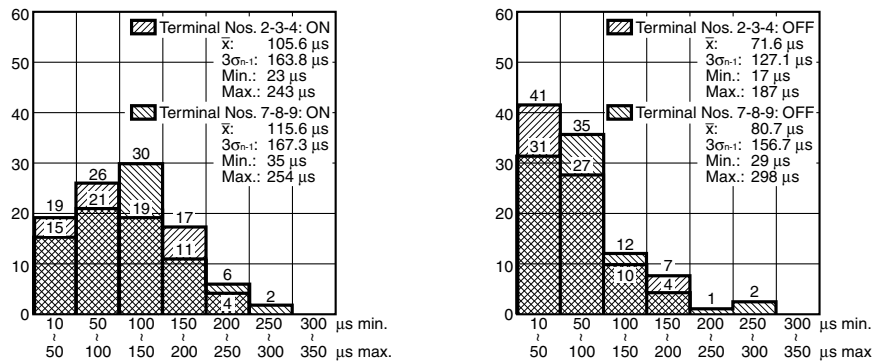

■ Surface-mount terminal

1. Maximum switching capacity



2. Life curve

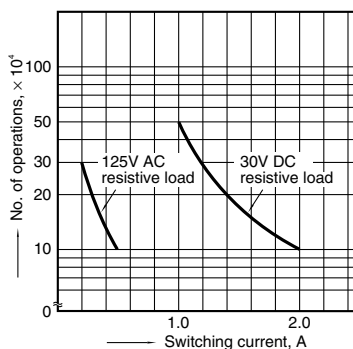

3. Mechanical life (mounting by IRS method)

Tested sample: TQ2SA-12V, 10 pcs.

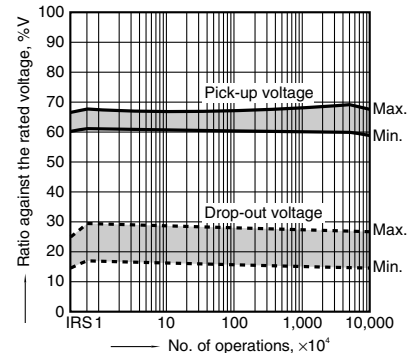

4.-(1) Electrical life (2 A 30 V DC resistive load)

Tested sample: TQ2SA-12V, 6 pcs.

Operating speed: 20 cpm

Change of pick-up and drop-out voltage

(mounting by IRS method)



Change of contact resistance (mounting by IRS method)

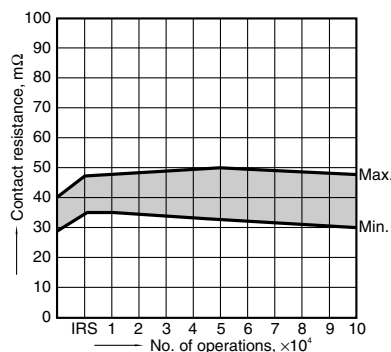

4.-(2) Electrical life (0.5 A 125 V AC resistive load)

Tested sample: TQ2SA-12V, 6 pcs

Operating speed: 20 cpm

Change of pick-up and drop-out voltage

(mounting by IRS method)

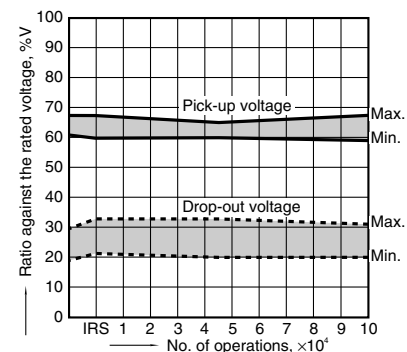

Change of contact resistance (mounting by IRS method)



5. Coil temperature rise

Tested sample: TQ2SA-12V, 6 pcs.

Point measured: Inside the coil

Ambient temperature: 25°C 77°F

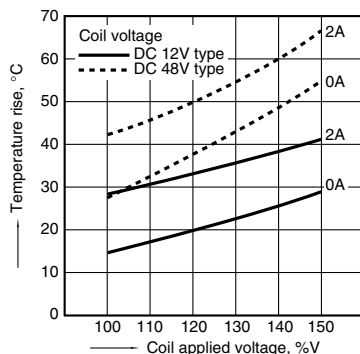

6. Operate/release time

Tested sample: TQ2SA-12V, 6 pcs.

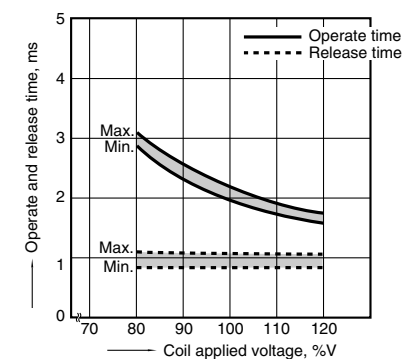

7. Ambient temperature characteristics

Tested sample: TQ2SA-12V, 5 pcs.



8.-(1) High-frequency characteristics (Isolation)



8.-(2) High-frequency characteristics (Insertion loss)



9. Malfunctional shock (single side stable)
Tested sample: TQ2SA-12V, 6 pcs



10.-(1) Influence of adjacent mounting
Tested sample: TQ2SA-12V, 5 pcs.

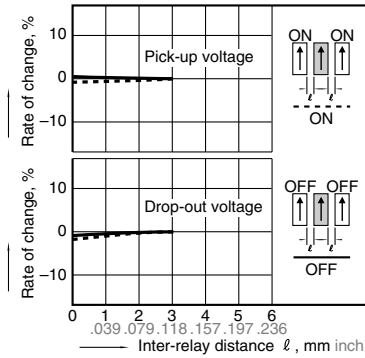

10.-(2) Influence of adjacent mounting
Tested sample: TQ2SA-12V, 6 pcs.



11. Pulse dialing test
(35 mA 48 V DC wire spring relay load)
Tested sample: TQ2SA-12V, 6 pcs.
Circuit



Change of pick-up and drop-out voltage
(mounting by IRS method)



Change of contact resistance
(mounting by IRS method)



DIMENSIONS (mm inch)

The CAD data of the products with a **CAD Data** mark can be downloaded from: <http://industrial.panasonic.com/ac/e/>

1. Standard PC board terminal and Self-clinching terminal

CAD Data



External dimensions
Standard PC board terminal



PC board pattern (Bottom view)



Tolerance: $\pm 0.1 \pm .004$

Self-clinching terminal



General tolerance: $\pm 0.3 \pm .012$

Schematic (Bottom view)

Single side stable



(Deenergized condition)

1-coil latching

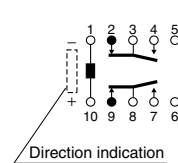

(Reset condition)

2-coil latching

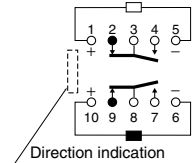

(Reset condition)

2. Surface-mount terminal

CAD Data



| Type | External dimensions (General tolerance: $\pm 0.3 \pm 0.12$) | Suggested mounting pad (Top view) (Tolerance: $\pm 0.1 \pm 0.04$) |
|---------|--|--|
| SA type | | |
| SL type | | |
| SS type | | |

Schematic (Top view)



NOTES

1. Packing style

1) The relay is packed in a tube with the relay orientation mark on the left side, as shown in the figure below.

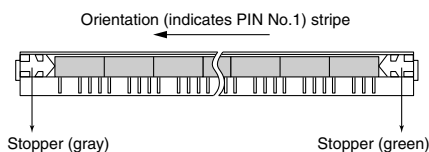

2) Tape and reel packing (surface-mount terminal type)

(1) Tape dimensions

(i) SA type

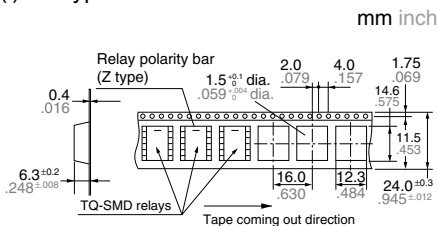

(ii) SL, SS type



(2) Dimensions of plastic reel

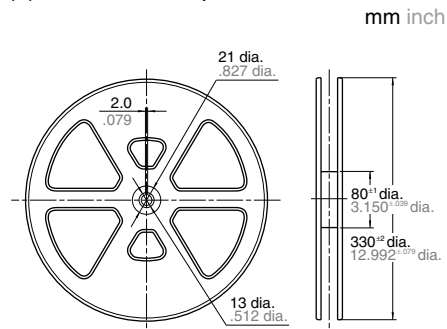

2. Automatic insertion

To maintain the internal function of the relay, the chucking pressure should not exceed the values below.

- Chucking pressure in the direction A: 9.8 N {1 kgf} or less
- Chucking pressure in the direction B: 9.8 N {1 kgf} or less
- Chucking pressure in the direction C: 9.8 N {1 kgf} or less

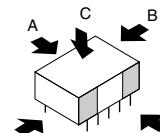

Please chuck the portion. Avoid chucking the center of the relay. In addition, excessive chucking pressure to the pinpoint of the relay should be avoided.

For general cautions for use, please refer to the "Cautions for use of Signal Relays" or "General Application Guidelines".

Mouser Electronics

Authorized Distributor

Click to View Pricing, Inventory, Delivery & Lifecycle Information:

Panasonic:

[TQ2-L2-3V](#) [TQ2-4.5V](#) [TQ2-L2-5V](#) [TQ2-5V](#) [TQ2-12V](#) [TQ2-24V](#) [TQ4-24V](#) [TQ2SS-1.5V](#) [TQ4-6V](#) [TQ4-L2-12V](#)
[TQ2-3V](#) [TQ4-3V](#) [TQ4-4.5V](#) [TQ2-L-5V](#) [TQ2H-5V](#) [TQ4-5V](#) [TQ2-6V](#) [TQ2-9V](#) [TQ2-L2-12V](#) [TQ4-12V](#) [TQ2-L2-24V](#)
[TQ2-L-3V](#) [TQ4-L2-5V](#) [TQ2-L2-4.5V](#) [TQ2-L2-6V](#) [TQ2-L2-9V](#) [TQ2-48V](#) [TQ2-L-4.5V](#) [TQ4-L2-24V](#)



Компания «ЭлектроПласт» предлагает заключение долгосрочных отношений при поставках импортных электронных компонентов на взаимовыгодных условиях!

Наши преимущества:

- Оперативные поставки широкого спектра электронных компонентов отечественного и импортного производства напрямую от производителей и с крупнейших мировых складов;
- Поставка более 17-ти миллионов наименований электронных компонентов;
- Поставка сложных, дефицитных, либо снятых с производства позиций;
- Оперативные сроки поставки под заказ (от 5 рабочих дней);
- Экспресс доставка в любую точку России;
- Техническая поддержка проекта, помощь в подборе аналогов, поставка прототипов;
- Система менеджмента качества сертифицирована по Международному стандарту ISO 9001;
- Лицензия ФСБ на осуществление работ с использованием сведений, составляющих государственную тайну;
- Поставка специализированных компонентов (Xilinx, Altera, Analog Devices, Intersil, Interpoint, Microsemi, Aeroflex, Peregrine, Syfer, Eurofarad, Texas Instrument, Miteq, Cobham, E2V, MA-COM, Hittite, Mini-Circuits, General Dynamics и др.);

Помимо этого, одним из направлений компании «ЭлектроПласт» является направление «Источники питания». Мы предлагаем Вам помощь Конструкторского отдела:

- Подбор оптимального решения, техническое обоснование при выборе компонента;
- Подбор аналогов;
- Консультации по применению компонента;
- Поставка образцов и прототипов;
- Техническая поддержка проекта;
- Защита от снятия компонента с производства.



Как с нами связаться

Телефон: 8 (812) 309 58 32 (многоканальный)

Факс: 8 (812) 320-02-42

Электронная почта: org@eplast1.ru

Адрес: 198099, г. Санкт-Петербург, ул. Калинина, дом 2, корпус 4, литера А.