

THIS DRAWING IS UNPUBLISHED. RELEASED FOR PUBLICATION 20
 © COPYRIGHT 20 BY - ALL RIGHTS RESERVED.

REVISIONS				
P	LTR	DESCRIPTION	DATE	APVD
	E12	REVISED PER ECO-13-016361	19OCT2013	KH MM

1 MATERIALS AND FINISH
 HOUSING: PA 6-6, UL 94-V0, COLOR: GREEN.
 CLAMP: BRASS, NICKEL PLATED.
 CONTACT SPRING : PHOSPHOR BRONZE, TIN PLATED.
 CLAMPING SCREW: M3, BRASS, NICKEL PLATED.

2. WIRE SIZE RANGE: 12 - 30 AWG

3 NOT CUMULATIVE TOLERANCE.

4 CHARACTERS MARKED IN PERMANENT WHITE COLOR.

5 PARTS SHOWN WITH INTEGRATED KEYING FEATURE LOCATED AS SHOWN.

6 CHARACTERS MARKED IN PERMANENT BLACK COLOR.

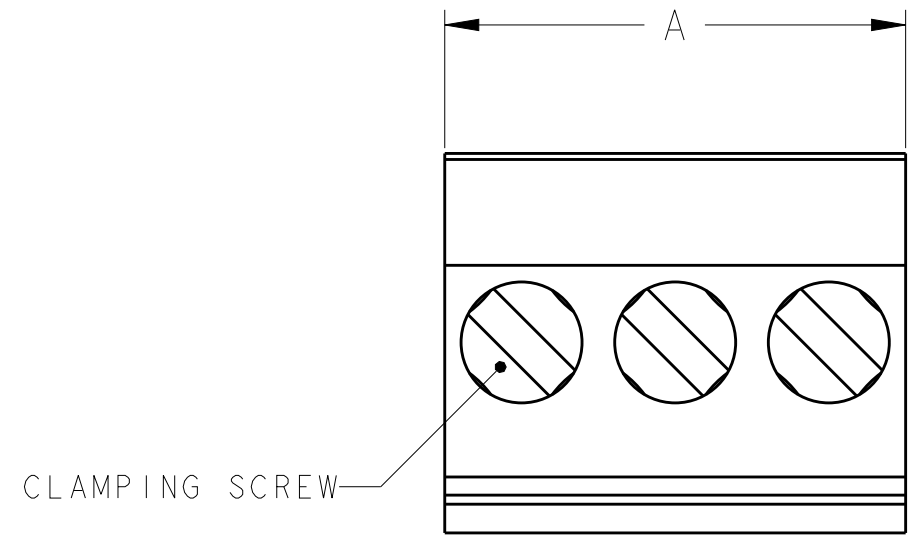

CLAMPING SCREW

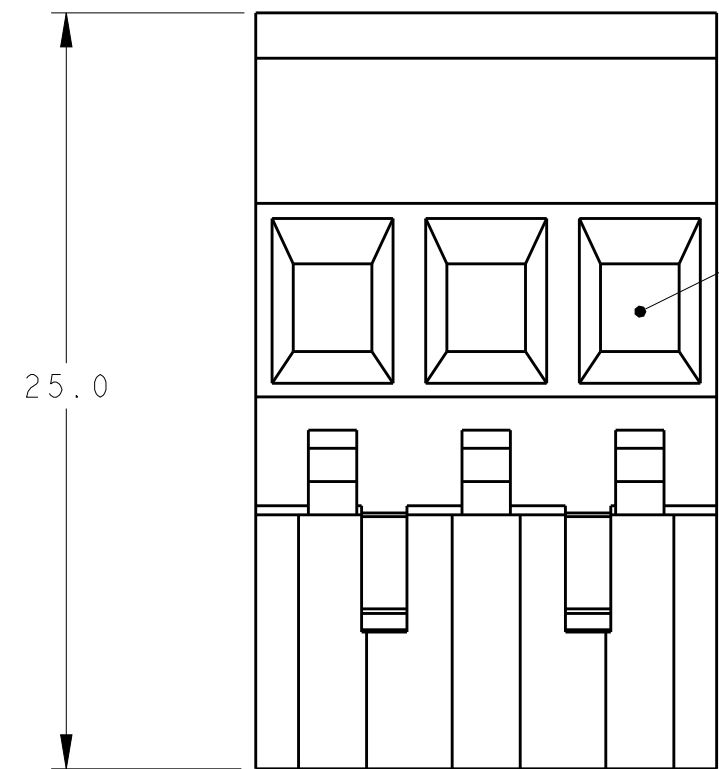

WIRE ENTRY

RETENTION LATCH

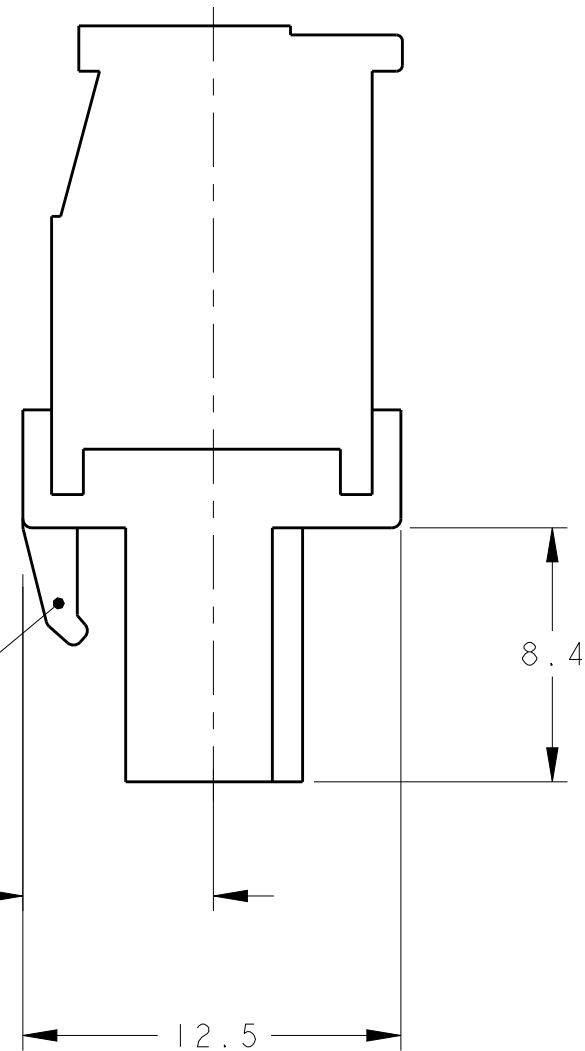

POLARIZATION KEY SLOT

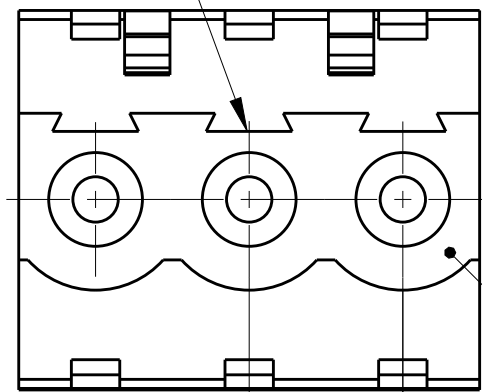

MATING FACE

2.54 REF TYP

3
 5.08±0.05 TYP

SEE DETAIL A-D	106.68	21	4-284047-1
SEE DETAIL A-C	106.68	21	4-284047-0
SEE DETAIL A-B	76.20	15	3-284047-9
SEE DETAIL A-A	76.20	15	3-284047-8
SEE DETAIL Z	121.92	24	3-284047-7
5 SEE DETAIL X	81.28	16	3-284047-6
5 SEE DETAIL W	81.28	16	3-284047-5
5 SEE DETAIL V	60.96	12	3-284047-4
5 SEE DETAIL U	60.96	12	3-284047-3
5 SEE DETAIL T	121.92	24	3-284047-2
5 SEE DETAIL S	121.92	24	3-284047-1
5 SEE DETAIL R	91.44	18	3-284047-0
5 SEE DETAIL P	91.44	18	2-284047-9
SEE DETAIL N	24.40	5	2-284047-8
SEE DETAIL M	20.32	4	2-284047-7
SEE DETAIL L	10.16	2	2-284047-6
-	127.00	25	2-284047-5
-	121.92	24	2-284047-4
-	116.84	23	2-284047-3
-	111.76	22	2-284047-2
-	106.68	21	2-284047-1
-	101.60	20	2-284047-0
-	96.52	19	1-284047-9
-	91.44	18	1-284047-8
-	86.36	17	1-284047-7
-	81.28	16	1-284047-6
-	76.20	15	1-284047-5
-	71.12	14	1-284047-4
-	66.04	13	1-284047-3
-	60.96	12	1-284047-2
-	55.88	11	1-284047-1
-	50.80	10	1-284047-0
-	45.72	9	284047-9
-	40.64	8	284047-8
-	35.56	7	284047-7
-	30.48	6	284047-6
-	25.40	5	284047-5
-	20.32	4	284047-4
-	15.24	3	284047-3
-	10.16	2	284047-2

MARKING	A	NO OF POSN	PART NUMBER
---------	---	------------	-------------

THIS DRAWING IS A CONTROLLED DOCUMENT.		DWN S. WELDON 05FEB2003
DIMENSIONS: mm		CHK C. RICHARD 05FEB2003
TOLERANCES UNLESS OTHERWISE SPECIFIED:		APVD C. RICHARD 05FEB2003
0 PLC ±-	±3	PRODUCT SPEC
1 PLC ±.3	±.25	APPLICATION SPEC
2 PLC ±-	±-	WEIGHT
3 PLC ±-	±-	CUSTOMER DRAWING
4 PLC ±-	±2	SCALE
ANGLES	±2	SHEET
FINISH		OF

STE TE Connectivity

NAME: TERMINAL BLOCK, VERTICAL PLUG, STACKING, RIGHT HAND, 5.08mm PITCH

SIZE: A2 CAGE CODE: 0779 DRAWING NO: C-284047 RESTRICTED TO: -

SCALE: 1:1 SHEET: 1 OF 8 REV: E12

THIS DRAWING IS UNPUBLISHED. RELEASED FOR PUBLICATION 20
 © COPYRIGHT 20 BY - ALL RIGHTS RESERVED.

REVISIONS				
P	LTR	DESCRIPTION	DATE	APVD
-		SEE SHEET 1	-	-

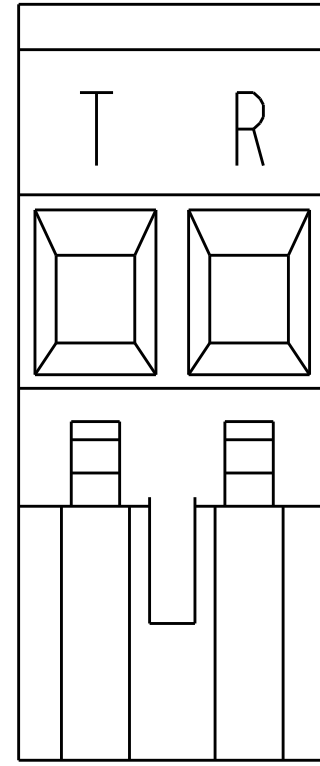

SEE DETAIL L

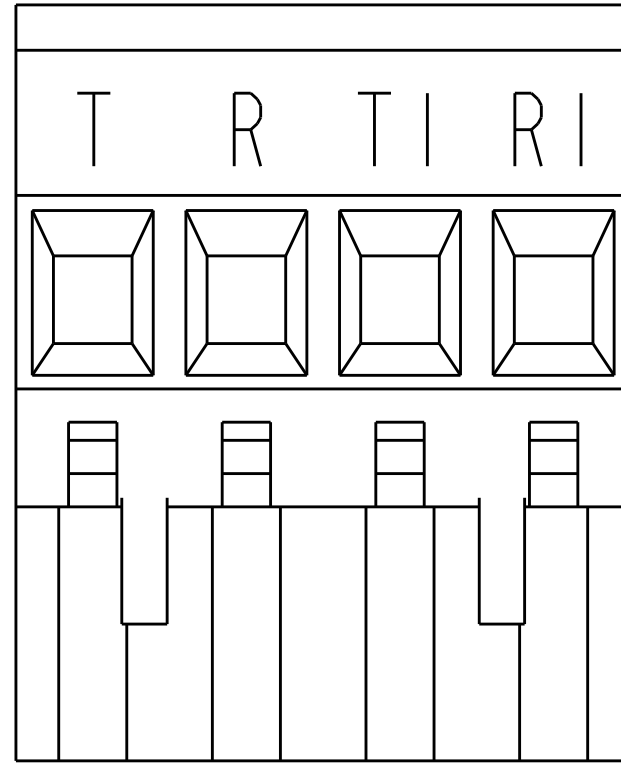

SEE DETAIL M

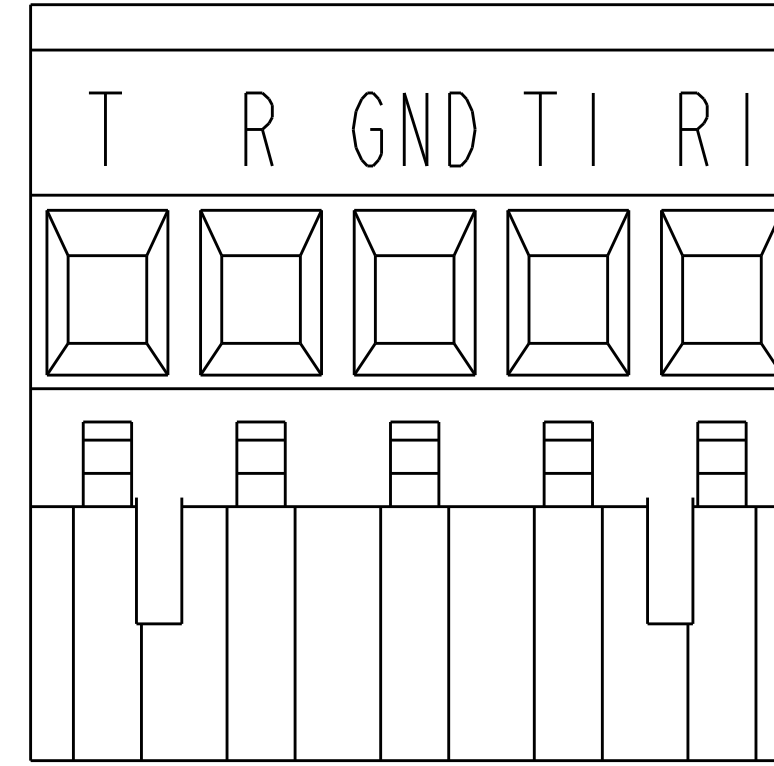

SEE DETAIL N

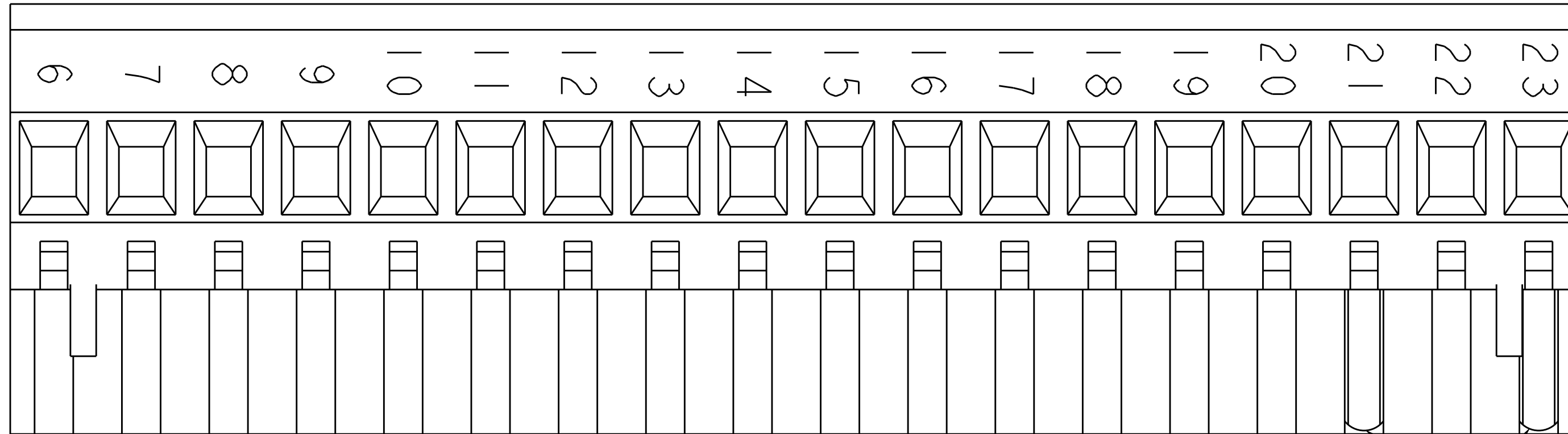

SEE DETAIL P



CODING KEY

THIS DRAWING IS A CONTROLLED DOCUMENT.		DWN S. WELDON 05FEB2003	TE Connectivity
DIMENSIONS:		CHK C. RICHARD 05FEB2003	
TOLERANCES UNLESS OTHERWISE SPECIFIED:		APVD C. RICHARD 05FEB2003	
mm		PRODUCT SPEC	
		APPLICATION SPEC	NAME TERMINAL BLOCK, VERTICAL PLUG, STACKING, RIGHT HAND, 5.08mm PITCH
MATERIAL	0 PLC ±- 1 PLC ±.3 2 PLC ±.25 3 PLC ±- 4 PLC ±- ANGLES ±2 FINISH	WEIGHT	SIZE A20779
		CUSTOMER DRAWING	CAGE CODE C-284047
			DRAWING NO SCALE 1:1
			SHEET 2 OF 8
			REV E12

THIS DRAWING IS UNPUBLISHED. RELEASED FOR PUBLICATION 20
 © COPYRIGHT 20 BY - ALL RIGHTS RESERVED.

REVISIONS				
P	LTR	DESCRIPTION	DATE	APVD
-	-	SEE SHEET 1	-	-

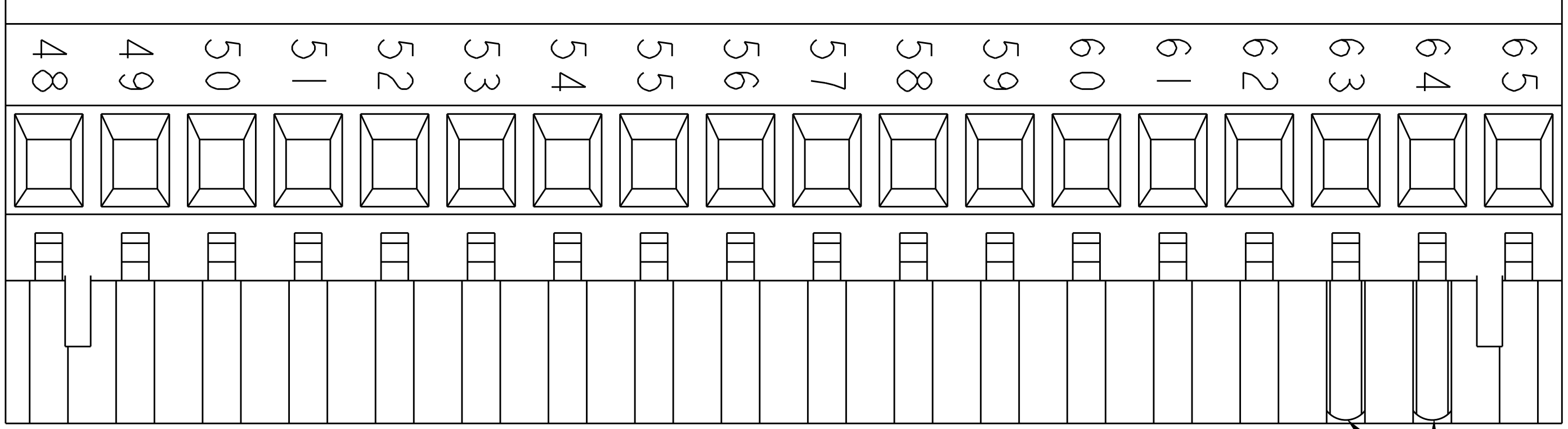

SEE DETAIL R

CODING KEY

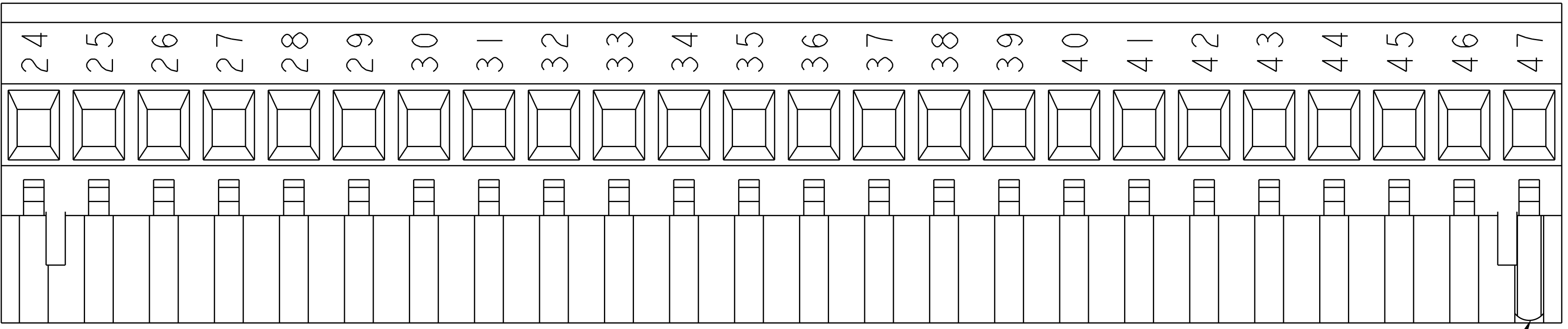

SEE DETAIL S

CODING KEY

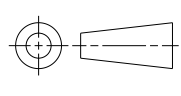
THIS DRAWING IS A CONTROLLED DOCUMENT.		DWN S. WELDON 05FEB2003	 TE Connectivity
DIMENSIONS: mm		CHK C. RICHARD 05FEB2003	
		APVD C. RICHARD 05FEB2003	
TOLERANCES UNLESS OTHERWISE SPECIFIED:		PRODUCT SPEC	
0 PLC ±.3		APPLICATION SPEC	NAME TERMINAL BLOCK, VERTICAL PLUG, STACKING, RIGHT HAND, 5.08mm PITCH
1 PLC ±.3		WEIGHT	SIZE A2
2 PLC ±.25		CUSTOMER DRAWING	CAGE CODE C-284047
3 PLC ±.		SCALE 1:1	DRAWING NO. 3 OF 8
4 PLC ±.		SHEET	RESTRICTED TO
ANGLES ±2		REV E12	
FINISH			

THIS DRAWING IS UNPUBLISHED. RELEASED FOR PUBLICATION 20
 © COPYRIGHT 20 BY - ALL RIGHTS RESERVED.

REVISIONS				
P	LTR	DESCRIPTION	DATE	APVD
-		SEE SHEET 1	-	-

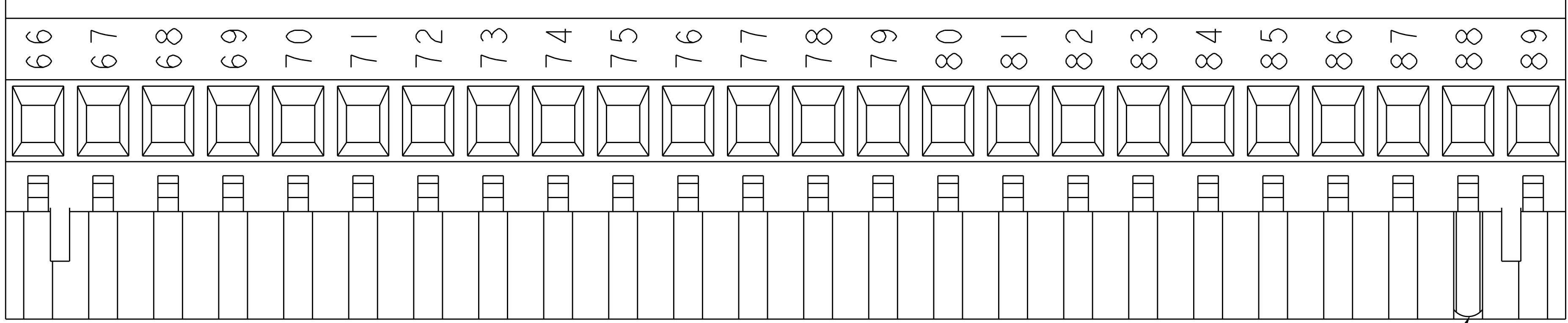

SEE DETAIL T

CODING KEY

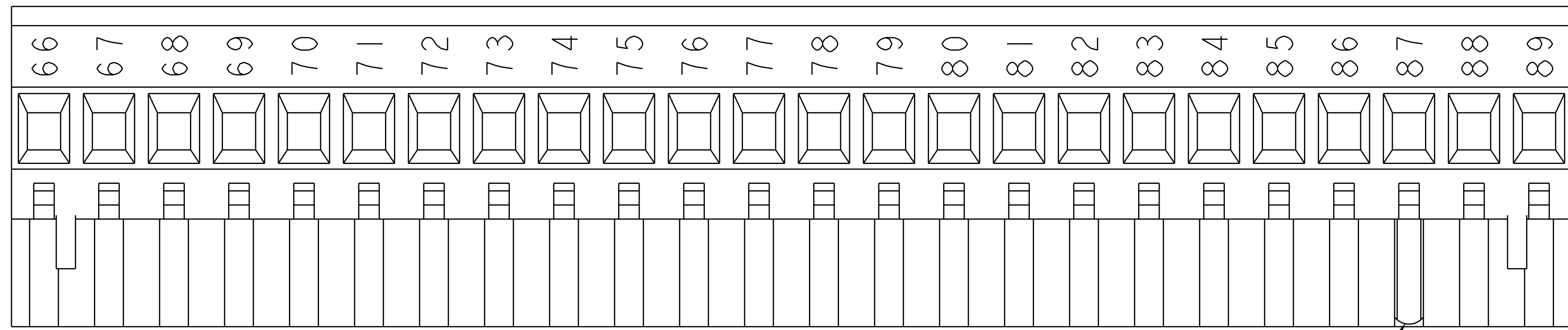

SEE DETAIL Z

CODING KEY

THIS DRAWING IS A CONTROLLED DOCUMENT.		DWN S. WELDON 05FEB2003	TE Connectivity	
		CHK C. RICHARD 05FEB2003		
		APVD C. RICHARD 05FEB2003	NAME	
		PRODUCT SPEC	TERMINAL BLOCK, VERTICAL PLUG, STACKING, RIGHT HAND, 5.08mm PITCH	
		APPLICATION SPEC	SIZE	RESTRICTED TO
		WEIGHT	A20779	
		CUSTOMER DRAWING	CAGE CODE	
			G-284047	
			DRAWING NO	
			SCALE	
			1:1	
			SHEET	
			4 OF 8	
			REV	
			E12	

THIS DRAWING IS UNPUBLISHED. RELEASED FOR PUBLICATION 20
 © COPYRIGHT 20 BY - ALL RIGHTS RESERVED.

REVISIONS				
P	LTR	DESCRIPTION	DATE	APVD
-		SEE SHEET 1	-	-

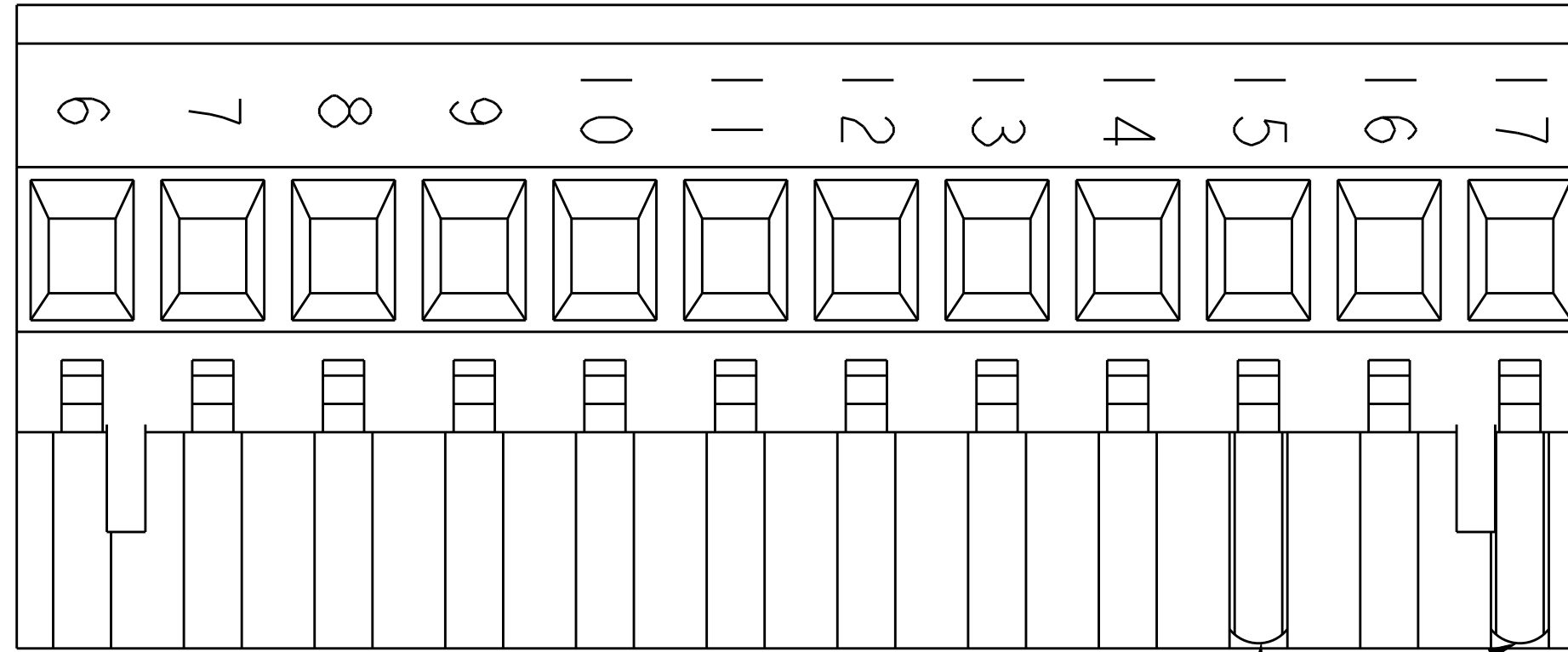

SEE DETAIL U



CODING KEY

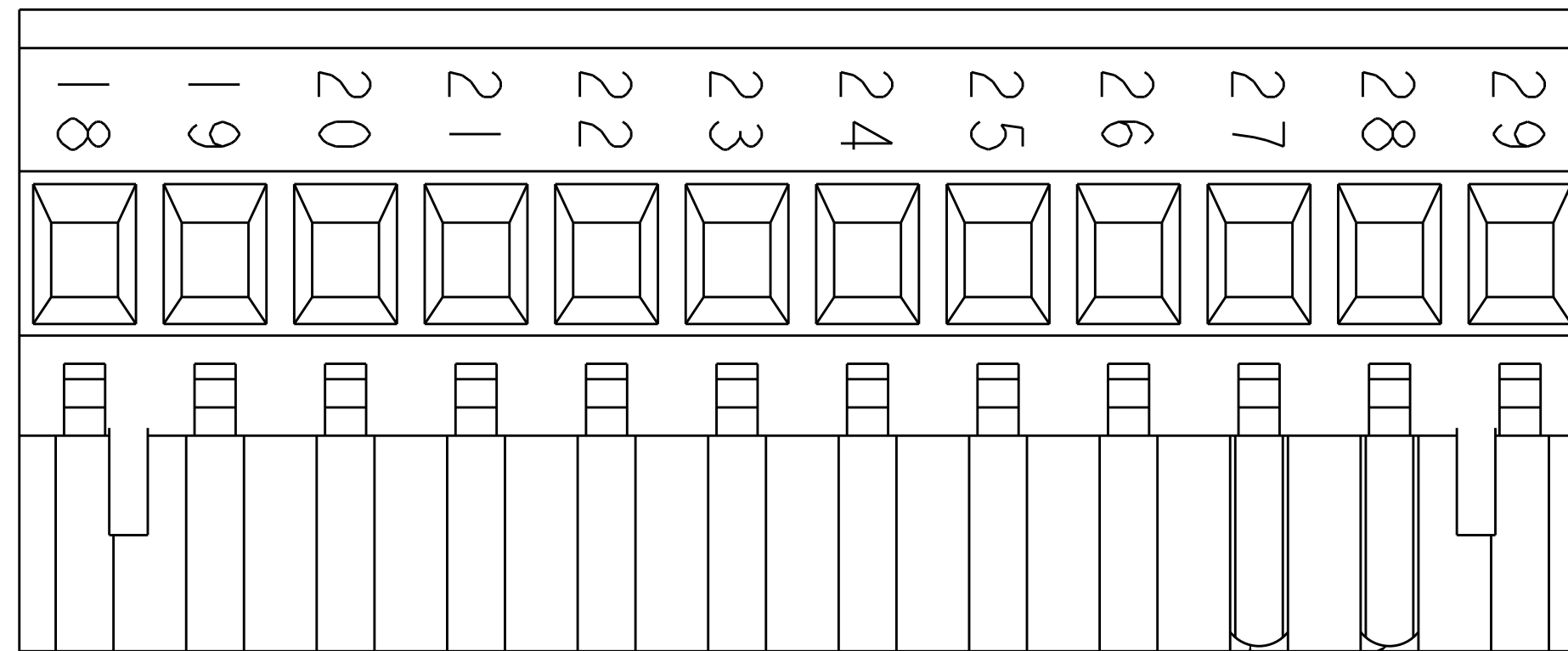

SEE DETAIL V



CODING KEY

THIS DRAWING IS A CONTROLLED DOCUMENT.		DWN S. WELDON 05FEB2003	TE Connectivity
DIMENSIONS:		CHK C. RICHARD 05FEB2003	
TOLERANCES UNLESS OTHERWISE SPECIFIED:		APVD C. RICHARD 05FEB2003	
mm		PRODUCT SPEC	
		APPLICATION SPEC	NAME TERMINAL BLOCK, VERTICAL PLUG, STACKING, RIGHT HAND, 5.08mm PITCH
MATERIAL	0 PLC ±- 1 PLC ±.3 2 PLC ±.25 3 PLC ±- 4 PLC ±- ANGLES ±2 FINISH	WEIGHT	SIZE CAGE CODE DRAWING NO RESTRICTED TO A20779 C-284047 -
		CUSTOMER DRAWING	SCALE 1:1 SHEET 5 OF 8 REV E12

THIS DRAWING IS UNPUBLISHED. RELEASED FOR PUBLICATION 20
 © COPYRIGHT 20 BY - ALL RIGHTS RESERVED.

REVISIONS				
P	LTR	DESCRIPTION	DATE	APVD
-	-	SEE SHEET 1	-	-

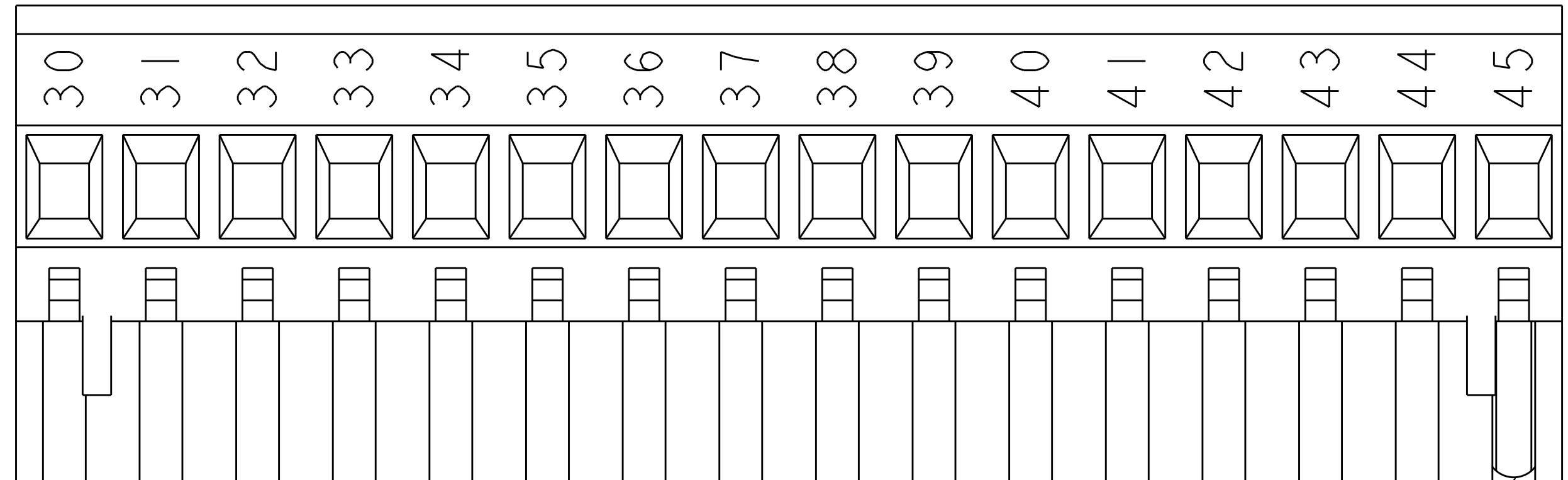

SEE DETAIL W



CODING KEY

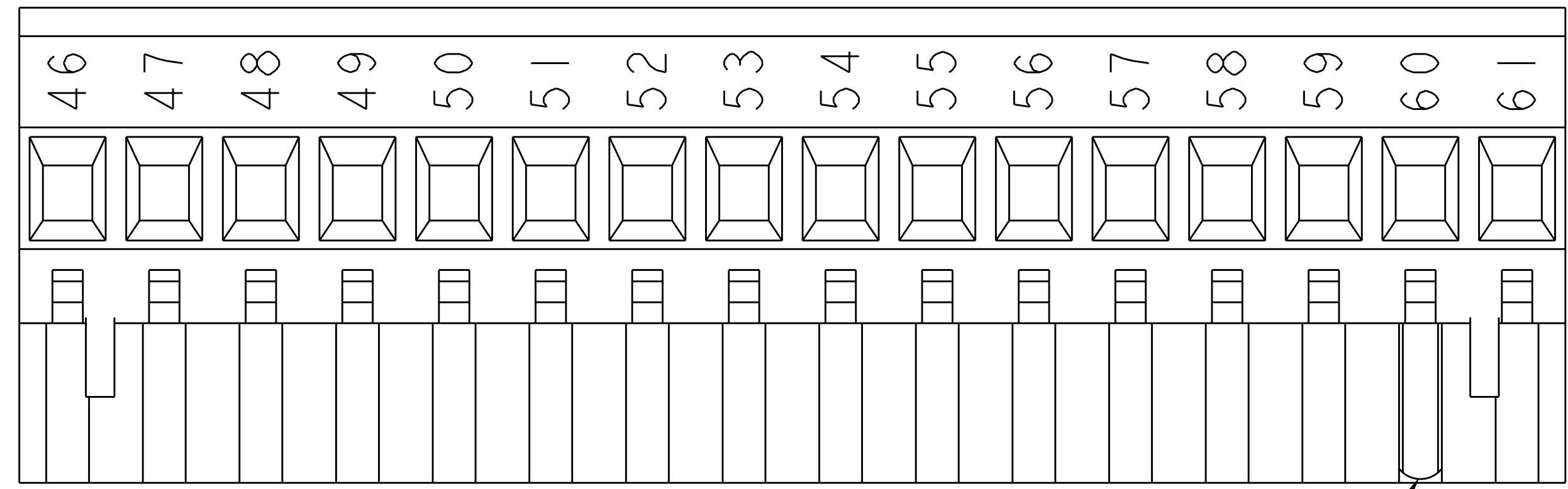

SEE DETAIL X



CODING KEY

THIS DRAWING IS A CONTROLLED DOCUMENT.		DWN S. WELDON 05FEB2003	 TE Connectivity
DIMENSIONS: mm		CHK C. RICHARD 05FEB2003	
TOLERANCES UNLESS OTHERWISE SPECIFIED:		APVD C. RICHARD 05FEB2003	
0 PLC ±- 1 PLC ±.3 2 PLC ±.25 3 PLC ±- 4 PLC ±- ANGLES ±2 FINISH -		PRODUCT SPEC - APPLICATION SPEC - WEIGHT -	
MATERIAL -		NAME TERMINAL BLOCK, VERTICAL PLUG, STACKING, RIGHT HAND, 5.08mm PITCH SIZE A2 CAGE CODE G-284047 DRAWING NO. RESTRICTED TO - CUSTOMER DRAWING SCALE 1:1 SHEET 6 OF 8 REV E12	

THIS DRAWING IS UNPUBLISHED. RELEASED FOR PUBLICATION 20
 © COPYRIGHT 20 BY - ALL RIGHTS RESERVED.

REVISIONS				
P	LTR	DESCRIPTION	DATE	APVD
-		SEE SHEET 1	-	-

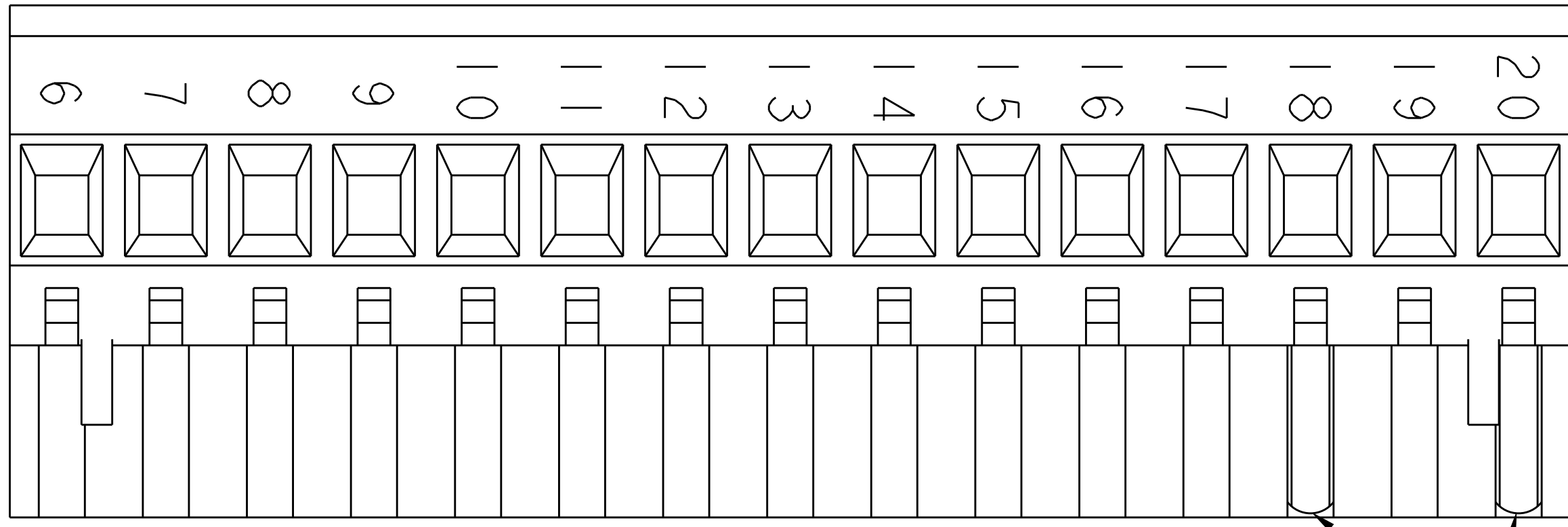

SEE DETAIL A-A

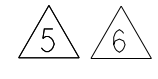

CODING KEY

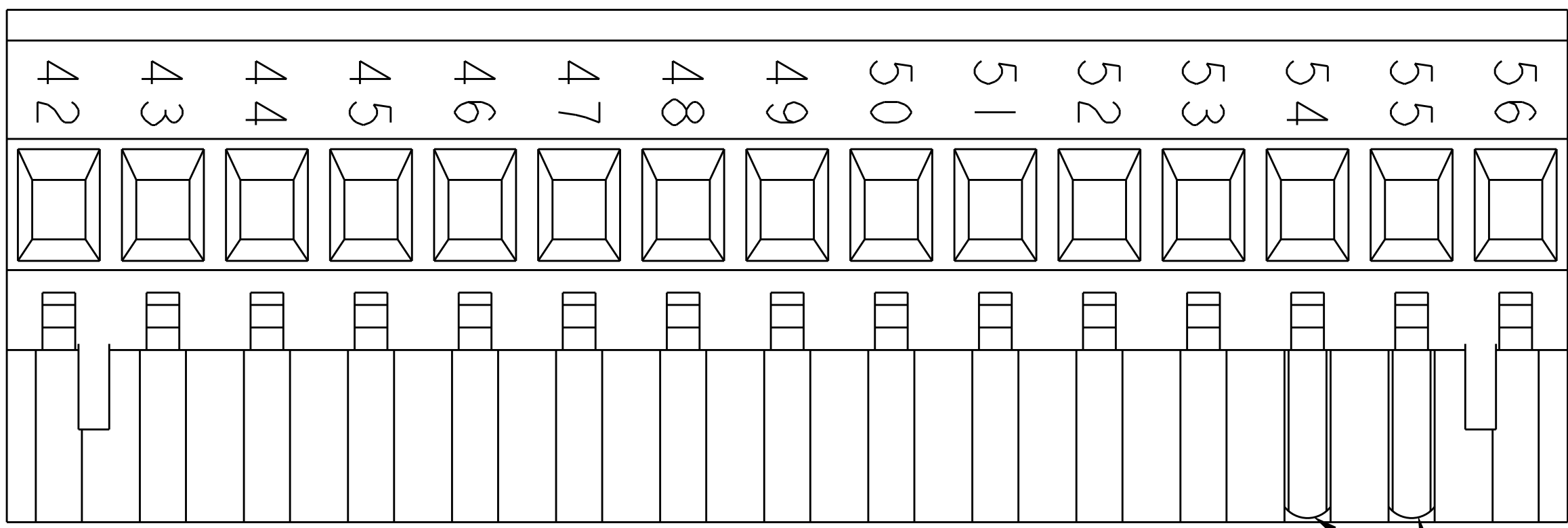

SEE DETAIL A-B

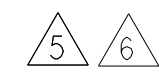

CODING KEY

THIS DRAWING IS A CONTROLLED DOCUMENT.		DWN S. WELDON 05FEB2003	TE Connectivity	
		CHK C. RICHARD 05FEB2003		
		APVD C. RICHARD 05FEB2003	NAME	
DIMENSIONS: mm 		PRODUCT SPEC	TERMINAL BLOCK, VERTICAL PLUG, STACKING, RIGHT HAND, 5.08mm PITCH	
TOLERANCES UNLESS OTHERWISE SPECIFIED: 0 PLC ±- 1 PLC ±.3 2 PLC ±.25 3 PLC ±- 4 PLC ±- ANGLES ±2 FINISH -		APPLICATION SPEC	SIZE	RESTRICTED TO
MATERIAL -		WEIGHT -	A20779	
		CUSTOMER DRAWING	DRAWING NO C-284047	
		SCALE 1:1	SHEET 7 OF 8	REV E12

THIS DRAWING IS UNPUBLISHED. RELEASED FOR PUBLICATION 20
 © COPYRIGHT 20 BY - ALL RIGHTS RESERVED.

REVISIONS				
P	LTR	DESCRIPTION	DATE	APVD
-		SEE SHEET 1	-	-

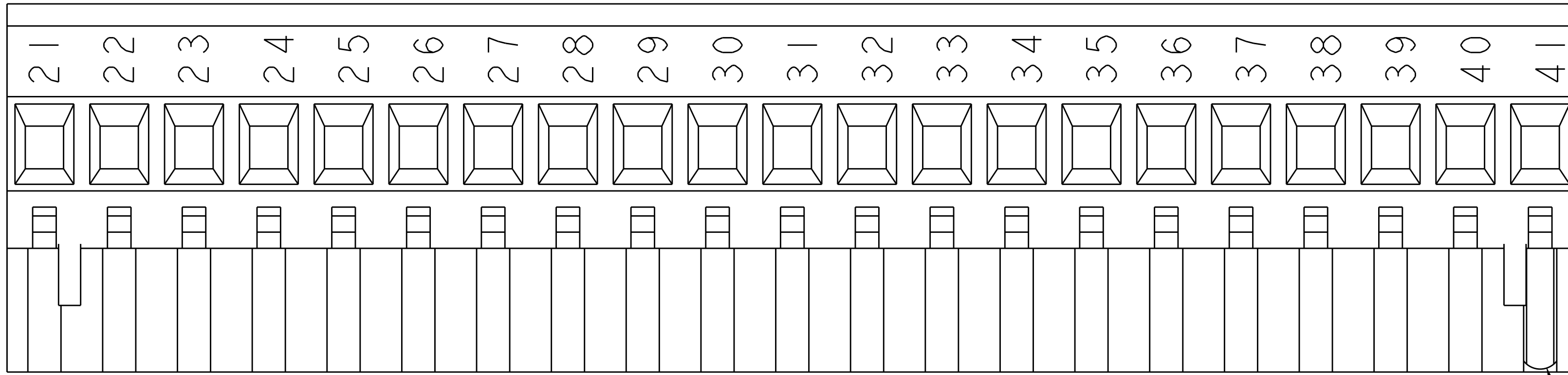

SEE DETAIL A-C



CODING KEY

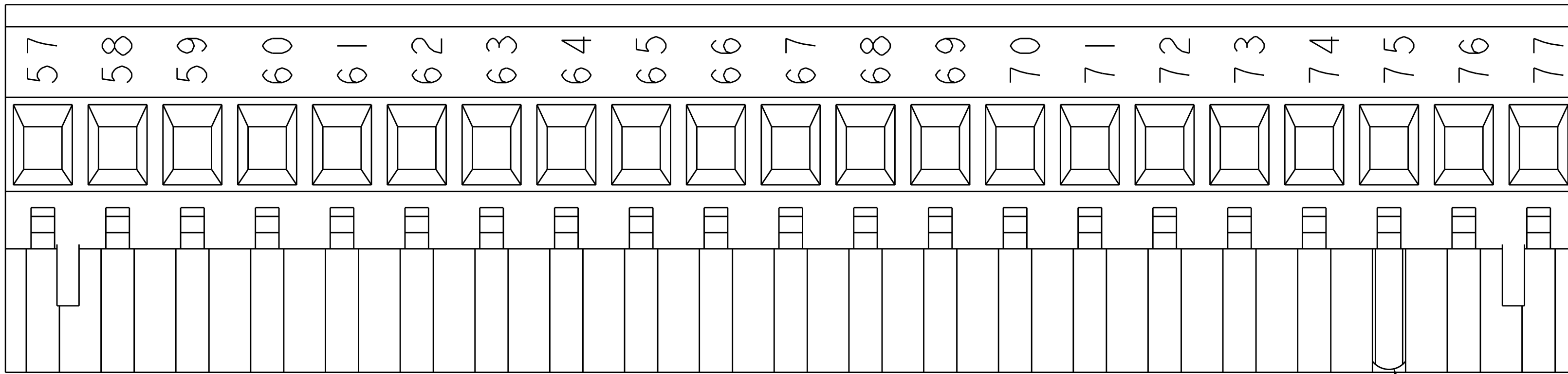

SEE DETAIL A-D

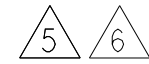

CODING KEY

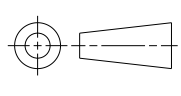
THIS DRAWING IS A CONTROLLED DOCUMENT.		DWN S. WELDON 05FEB2003	 TE Connectivity
		CHK C. RICHARD 05FEB2003	
		APVD C. RICHARD 05FEB2003	
		PRODUCT SPEC	
DIMENSIONS: mm 		APPLICATION SPEC	NAME TERMINAL BLOCK, VERTICAL PLUG, STACKING, RIGHT HAND, 5.08mm PITCH
TOLERANCES UNLESS OTHERWISE SPECIFIED: 0 PLC ±- 1 PLC ±.3 2 PLC ±.25 3 PLC ±- 4 PLC ±- ANGLES ±2 FINISH		WEIGHT	SIZE CAGE CODE DRAWING NO RESTRICTED TO A200779 C-284047 -
MATERIAL		CUSTOMER DRAWING	SCALE 1:1 SHEET 8 OF 8 REV E12



Компания «ЭлектроПласт» предлагает заключение долгосрочных отношений при поставках импортных электронных компонентов на взаимовыгодных условиях!

Наши преимущества:

- Оперативные поставки широкого спектра электронных компонентов отечественного и импортного производства напрямую от производителей и с крупнейших мировых складов;
- Поставка более 17-ти миллионов наименований электронных компонентов;
- Поставка сложных, дефицитных, либо снятых с производства позиций;
- Оперативные сроки поставки под заказ (от 5 рабочих дней);
- Экспресс доставка в любую точку России;
- Техническая поддержка проекта, помощь в подборе аналогов, поставка прототипов;
- Система менеджмента качества сертифицирована по Международному стандарту ISO 9001;
- Лицензия ФСБ на осуществление работ с использованием сведений, составляющих государственную тайну;
- Поставка специализированных компонентов (Xilinx, Altera, Analog Devices, Intersil, Interpoint, Microsemi, Aeroflex, Peregrine, Syfer, Eurofarad, Texas Instrument, Miteq, Cobham, E2V, MA-COM, Hittite, Mini-Circuits, General Dynamics и др.);

Помимо этого, одним из направлений компании «ЭлектроПласт» является направление «Источники питания». Мы предлагаем Вам помощь Конструкторского отдела:

- Подбор оптимального решения, техническое обоснование при выборе компонента;
- Подбор аналогов;
- Консультации по применению компонента;
- Поставка образцов и прототипов;
- Техническая поддержка проекта;
- Защита от снятия компонента с производства.



Как с нами связаться

Телефон: 8 (812) 309 58 32 (многоканальный)

Факс: 8 (812) 320-02-42

Электронная почта: org@eplast1.ru

Адрес: 198099, г. Санкт-Петербург, ул. Калинина, дом 2, корпус 4, литера А.