

# 8020 Series Snap-acting Momentary Pushbutton Switches

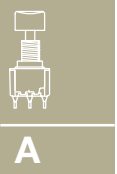

Pushbutton

## Features/Benefits

- Positive tactile feel
- Multi-positions available
- Wide variety of termination options
- Epoxy terminal seal compatible with bottom wash cleaning
- RoHS compliant models available



Models Available

## Typical Applications

- Instrumentation
- Computer peripherals
- Telecommunications equipment



## Specifications

CONTACT RATING: B contact material (8X25 Models): 0.4 VA max. @ 20 V AC or DC maximum. G contact material (8X21, U8X1 Models): 1 AMP @ 120 V AC or 28 V DC or 0.4 VA max. @ 20 V AC or DC max. Note: Break-before-makecontacts. Multi-pole contacts do not make and break simultaneously. See page A-43 for additional ratings.

ELECTRICAL LIFE: 60,000 make-and-break cycles at full load.

CONTACT RESISTANCE: Below 50 mΩ typ. initial @ 2-4 V DC, 100 mA, for both silver and gold plated contacts.

INSULATION RESISTANCE: 10<sup>9</sup>Ω min.

DIELECTRIC STRENGTH: 1,000 Vrms min. @ sea level.

OPERATING TEMPERATURE: 8X2X MODELS: -30°C to 75°C.  
U8X1 MODELS: -30°C to 65°C.

CAP INSTALLATION FORCE: 10 lbs. max. permissible.

SOLDERABILITY: Per MIL-STD-202F method 208D, or EIA RS-186E method 9 (1 hour steam aging).

**NOTE:** Any models supplied with B, P, R, or G contact material are RoHS compliant.

**NOTE:** Specifications and materials listed above are for switches with standard options. For information on specific and custom switches, consult Customer Service Center.

## Materials

CASE: Glass filled nylon 6/6 or diallyl phthalate (DAP), flame retardant (UL 94V-0).

PLUNGER: Glass filled nylon or glass filled polyester (PBT) (UL 94V-0).

CAP & FRAME: Nylon, black, standard.

BUSHING: Brass or zinc, nickel plated.

HOUSING: Stainless steel.

SWITCH SUPPORT: Brass or steel, matte-tin plated.

N.O. & N.C. CONTACTS: 8X21, U8X1 MODELS: G contact material: Coin silver, with gold plate over nickel plate. See page A-43 for additional contact materials.

8X25 MODELS: B contact material: Copper alloy, with gold plate over nickel plate. See page A-43 for additional contact materials.

COMMON CONTACT & ALL TERMINALS: Copper alloy, with gold plate over nickel plate.

TERMINAL SEAL: Epoxy. Refer to soldering and cleaning Technical Data Chapter.

HARDWARE: Nut & Locking Ring: Brass, nickel plated;  
Lockwasher: Steel, nickel plated.

## Build-A-Switch

To order, simply select desired option from each category and place in the appropriate box. Available options are shown and described on pages A-30 thru A-45. For additional options not shown in catalog, consult Customer Service Center. All models have epoxy terminal seal and are compatible with all "bottom-wash" PCB cleaning methods.



### Switch Function

- 8121** SPDT On-Mom. 1 Amp
- 8125** SPDT On-Mom. 0.4VA
- 8221** DPDT On-Mom. 1 Amp
- 8225** DPDT On-Mom. 0.4VA
- 8321** 3PDT On-Mom. 1 Amp
- 8325** 3PDT On-Mom. 0.4VA
- 8421** 4PDT On-Mom. 1 Amp
- 8425** 4PDT On-Mom. 0.4VA

**Note:** UL models available, see page A-30 and A-31.

### Actuator or Plunger

- S** Plunger
- NONE** Snap-in
- J80** Snap-in
- J81** Snap-in w/frame
- J82** Snap-in w/frame for LED
- J83** Snap-in w/frame & flush cap
- J84** Snap-in w/frame for LED, flush cap
- J85** Snap-in w/frame & LED
- J95** PC w/V-bracket & LED
- L** Plunger
- M** Snap-fitting plunger

### Bushing

- D9** .280" high, keyway
- H** .250" high, flat
- NONE** No bushing choice required
- D** .280" high, keyway
- D2** .288" high, flat
- D3** .180" high
- D8** .288" high, flat
- H9** .250" high, flat, hi torque
- Y** .350" high, keyway
- Y3** 6.35mm high, keyway, hi torque
- Y4** .378" high, flat, hi torque
- Y9** .350" high, keyway

### Contact Material

- B** Gold
- P** Gold, matte-tin
- G** Gold over silver
- R** Gold over silver, matte-tin

### Seal

- E** Epoxy
- I** Epoxy potted base

### Cap Color

- 2** Black
- NONE** Models without caps
- 1** White
- 3** Red
- 4** Orange
- 5** Yellow
- 6** Green
- 7** Blue
- 9** Gray

### Frame Color

- 2** Black
- NONE** Models without frame
- 1** White
- 3** Red
- 5** Yellow
- 6** Green
- 9** Gray

### LED Color

- 3** Red
- NONE** Models without LED
- 5** Yellow
- 6** Green

### Terminations

- A** Right angle, PC thru-hole
- AV2** Vertical right angle, PC thru-hole
- C** PC Thru-hole
- Z** Solder lug
- A2** Right angle, PC thru-hole
- A3** Right angle, snap-in, PC thru-hole
- A4** Right angle, PC thru-hole, reversed terminals
- A6** Right angle, PC thru-hole
- AV1** Vertical right angle, PC thru-hole
- AV3** Vertical right angle, snap-in, PC thru-hole
- R** Right angle with PCB
- R2** Right angle with PCB, reversed terminals
- V2** .555" high, V-bracket
- V3** .460" high, V-bracket
- V4** .630" high, V-bracket
- V6** .460" high, V-bracket
- V7** .630" high, V-bracket
- V8** .953" high, V-bracket
- V9** 1.150" high, V-bracket
- V31** .460" high, snap-in V-bracket
- V61** .460" high, snap-in V-bracket
- W** .750" long, wire wrap
- W1** .964" long, wire wrap
- W3** .425" long, wire wrap
- W4** 1.062" long, wire wrap
- Z3** Quick connect



Dimensions are shown: Inches (mm)  
Specifications and dimensions subject to change



# 8020 Series Snap-acting Momentary Pushbutton Switches

## SWITCH FUNCTION

Pushbutton  
A

NO. POLES	MODEL NO.	UL/CSA* MODEL NO.	SWITCH FUNCTION		CONNECTED TERMINALS		SCHEMATIC
			POS. 1	POS. 2	POS. 1	POS. 2	
SP	8121	U811	ON	MOM.	1-3	1-2	
	8125		ON	MOM.			
<p><b>SPDT</b></p> <p>Part number shown: 8121SHZGE</p> <p>Terminal Nos. For Reference Only</p>							
DP	8221	U821	ON	MOM.	1-3,4-6	1-2,4-5	
	8225		ON	MOM.			
<p><b>DPDT</b></p> <p>Part number shown: 8221SHZGE</p> <p>Terminal Nos. For Reference Only</p>							
3P	8321	U831	ON	MOM.	1-3,4-6,7-9	1-2,4-5,7-8	
	8325		ON	MOM.			
<p><b>3PDT</b></p> <p>Part number shown: 8321SHZGE</p> <p>Terminal Nos. For Reference Only</p>							

MOM. = Momentary

\*U811 thru U841 model numbers with all options (except R, R2 terminations) when ordered with G or R contact material.

8X25 models must be ordered with B or P contact material.

8X21 and U8X1 models must be ordered with G or R contact material.



Dimensions are shown: Inches (mm)  
Specifications and dimensions subject to change

www.ck-components.com

# 8020 Series Snap-acting Momentary Pushbutton Switches



A

Pushbutton

## SWITCH FUNCTION

NO. POLES	MODEL NO.	UL/CSA* MODEL NO.	SWITCH FUNCTION		CONNECTED TERMINALS		SCHEMATIC
			POS. 1	POS. 2	POS. 1	POS. 2	
4P	8421	U841	ON	MOM.	1-3,4-6,7-9,10-12	1-2,4-5,7-8,10-11	
	8425		ON	MOM.			

### 4PDT

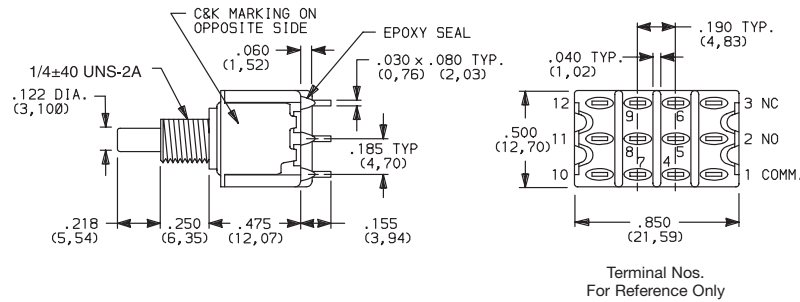

Part number shown: 8421SHZGE

Terminal Nos. For Reference Only

MOM. = Momentary

\* U811 thru U841 model numbers with all options (except R, R2 terminations) when ordered with G or R contact material.

8X25 models must be ordered with B or P contact material.

8X21 and U8X1 models must be ordered with G or R contact material.

## ACTUATOR—SNAP-IN FRONT MOUNT

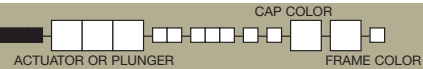

OPTION CODE	CAP AND FRAME COLOR
2	BLACK
NONE	No Frame Color (J80 option)
1	WHITE
3	RED
4	ORANGE
5	YELLOW
6	GREEN
7	BLUE
9	GRAY

Other colors available, consult Customer Service Center. Cap and Frame Finish: matte.

NOTE: Caps and frames available separately, see pages A-44 and A-45.

### J80 SNAP-IN

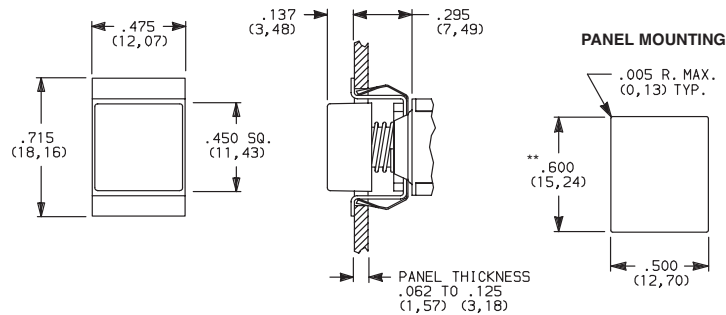

NOTE: No frame color choice required.

\*\* Increase this dim. to .620/.625 (15,75/15,88) for .091/.125 (2,31/3,18) thk. panels.

### J81 SNAP-IN WITH FRAME

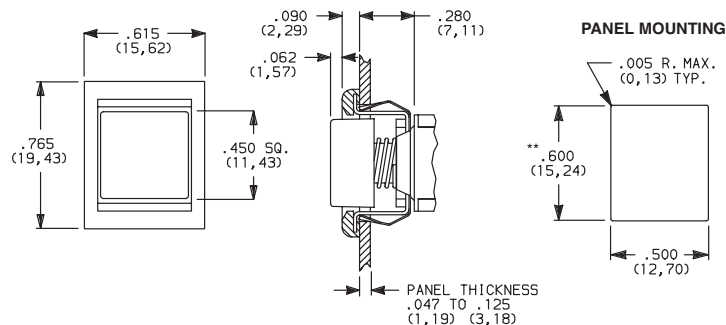

NOTE: Available with C, W-W4, Z or Z3 terminations and SPDT and DPDT models only.

\*\* Increase this dim. to .620/.625 (15,75/15,88) for .091/.125 (2,31/3,18) thk. panels.

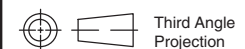

Third Angle Projection



Dimensions are shown: Inches (mm)  
Specifications and dimensions subject to change



# 8020 Series Snap-acting Momentary Pushbutton Switches

Pushbutton  
A

## ACTUATOR—SNAP-IN FRONT MOUNT



### J83 SNAP-IN WITH FRAME AND FLUSH CAP

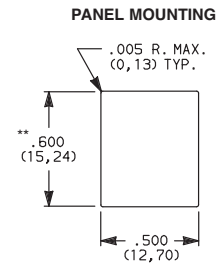
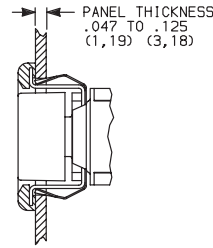
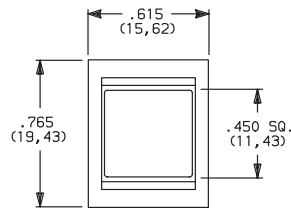

### J82 SNAP-IN WITH FRAME FOR LED

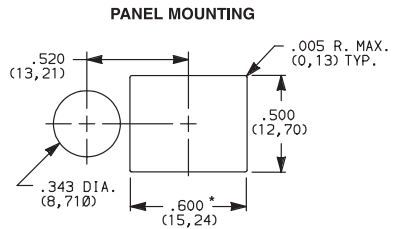
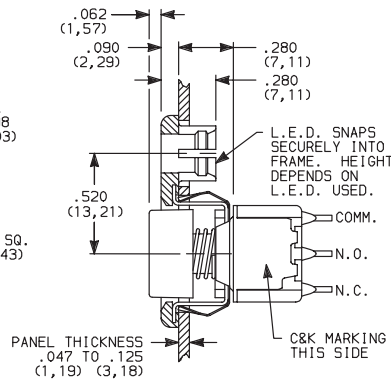
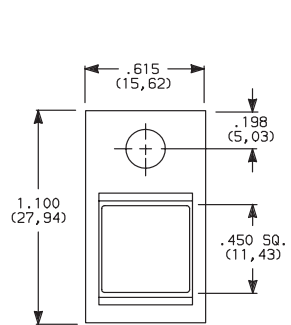

\* Increase this dim. to .620/.625 (15,75/15,88) for .091/.125 (2,31/3,18) thk. panels.

LED not included.  
For LED information, see page A-45.

### J84 SNAP-IN WITH FRAME FOR LED, FLUSH CAP

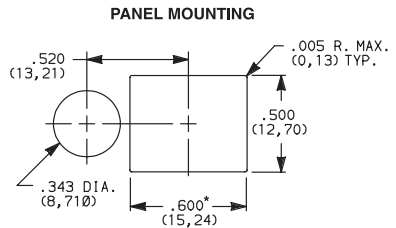
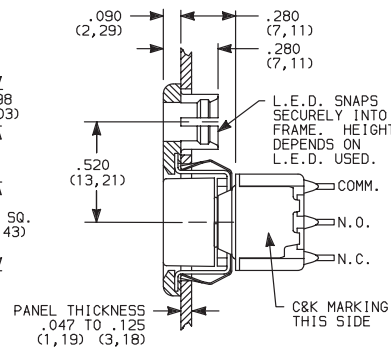
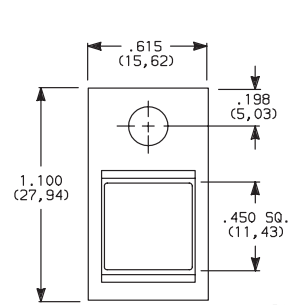

\* Increase this dim. to .620/.625 (15,75/15,88) for .091/.125 (2,31/3,18) thk. panels.

LED not included.  
For LED information, see page A-45.

OPTION CODE	CAP AND FRAME COLOR
2	BLACK
1	WHITE
3	RED
4	ORANGE
5	YELLOW
6	GREEN
7	BLUE
9	GRAY

Other colors available, consult Customer Service Center.  
Cap and Frame Finish: matte.

Available with C, W-W4, Z or Z3 terminations and SPDT and DPDT models only.

**NOTE:** Caps and frames available separately, see pages A-44 and A-45.



Dimensions are shown: Inches (mm)  
Specifications and dimensions subject to change

# 8020 Series Snap-acting Momentary Pushbutton Switches



A

Pushbutton

## ACTUATOR—SNAP-IN FRONT MOUNT

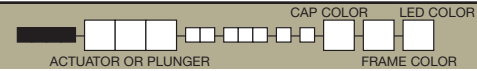

### J85 SNAP-IN WITH FRAME AND LED

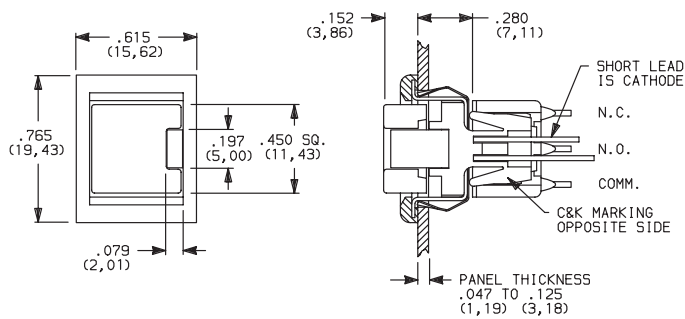

### PANEL MOUNTING

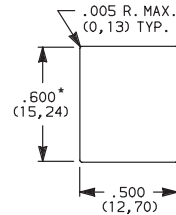

\* Increase this dim. to .620/.625 (15,75/15,88) for .091/.125 (2,31/3,18) thk. panels.



8121J85ZGE223  
SPST

Available with C, W-W4, Z or Z3 terminations and SPDT models only. For LED information see page A-45.

**NOTE:** Caps & frames available separately, see pages A-44 and A-45.

OPTION CODE	CAP AND FRAME COLOR
2	BLACK
1	WHITE
3	RED
4	ORANGE
5	YELLOW
6	GREEN
7	BLUE
9	GRAY

OPTION CODE	LED COLOR
3	RED
5	YELLOW
6	GREEN

For LED information see page A-45.

## ACTUATOR—PC MOUNT

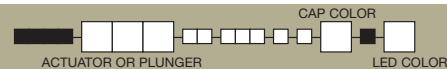

### J95 PC WITH V-BRACKET AND LED

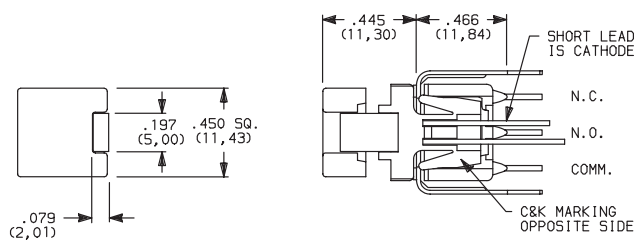

### PC MOUNTING

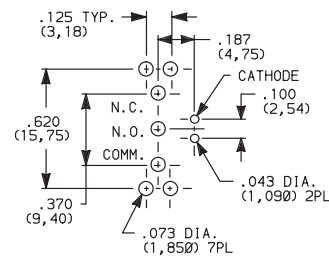

8121J95V3GE23  
SPST

OPTION CODE	CAP AND FRAME COLOR
2	BLACK
1	WHITE
3	RED
4	ORANGE
5	YELLOW
6	GREEN
7	BLUE
9	GRAY

OPTION CODE	LED COLOR
3	RED
5	YELLOW
6	GREEN

For LED information see page A-45.

**NOTE:** Caps available separately, see page A-44. Available with V3 terminations and SPDT models only.

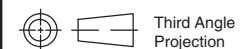

Third Angle Projection



Dimensions are shown: Inches (mm)  
Specifications and dimensions subject to change

www.ck-components.com



# 8020 Series Snap-acting Momentary Pushbutton Switches

Pushbutton

A

## PLUNGER



### S PLUNGER

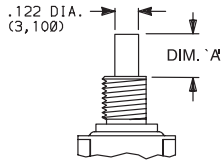

**NONE** NO PLUNGER CHOICE REQUIRED (JXX ACTUATORS)

### L PLUNGER

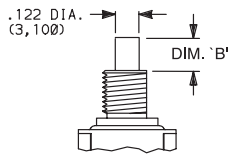

### M SNAP-FITTING PLUNGER

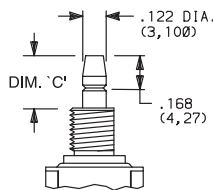

AVAILABLE BUSHINGS	DIM. 'A' FOR C, W-W4, Z & Z3 TERMINATIONS	DIM. 'A' FOR A, A2, A3, A4, A6, AV-A3, R & R2 TERMINATIONS	DIM. 'A' FOR V3-V61 TERMINATIONS
D, D9	.244 (6,20)	.228 (5,79)	.224 (5,69)
H, H9	.218 (5,54)	.202 (5,13)	.198 (5,03)
Y, Y9	.203 (5,16)	.187 (4,75)	.183 (4,65)
Y3	(5,54)	(5,13)	(5,03)
Y4	.185 (4,70)	.169 (4,29)	.165 (4,19)
D2, D8	N/A	.232 (5,89)	.228 (5,79)
D3	N/A	.162 (4,11)	.158 (4,01)

AVAILABLE BUSHINGS	DIM. 'B' FOR C, W-W4, Z & Z3 TERMINATIONS	DIM. 'B' FOR A, A2, A3, A4, A6, AV-A3, R & R2 TERMINATIONS	DIM. 'B' FOR V3-V61 TERMINATIONS
Y, Y9	.178 (4,52)	.162 (4,11)	.158 (4,01)
Y4	.090 (2,29)	.074 (1,88)	.070 (1,78)

AVAILABLE BUSHINGS	DIM. 'C' FOR C, W-W4, Z & Z3 TERMINATIONS	DIM. 'C' FOR A, A2, A3, A4, A6, AV-A3, R & R2 TERMINATIONS	DIM. 'C' FOR V3-V61 TERMINATIONS
D, D9	.297 (7,54)	.281 (7,14)	.277 (7,04)
H, H9	.267 (6,78)	.251 (6,38)	.247 (6,27)
Y, Y9	.259 (6,58)	.243 (6,17)	.239 (6,07)
Y3	(6,78)	(6,37)	(6,27)
Y4	.259 (6,58)	.243 (6,17)	.239 (6,07)
D2, D8	N/A	.273 (6,93)	.269 (6,83)
D3	N/A	.361 (9,17)	.357 (9,07)

N/A = NOT AVAILABLE

**NOTE:** When selecting plunger option, bushing selection must also be made, see next page. No plunger option is required when any JXX actuator option is selected. Additional plunger lengths are available on SPDT and DPDT models, consult Customer Service Center. Not all plunger lengths sufficient for use with caps, see page A-44.

## BUSHING

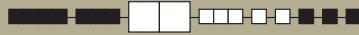

**NONE** NO BUSHING CHOICE REQUIRED (JXX ACTUATORS)

**D** .280" HIGH THREADED, KEYWAY  
**D9** .280" HIGH UNTHREADED, KEYWAY

**H** .250" HIGH THREADED, FLAT  
**H9** .250" HIGH UNTHREADED, FLAT

**Y** .350" HIGH THREADED, KEYWAY  
**Y9** .350" HIGH UNTHREADED, KEYWAY

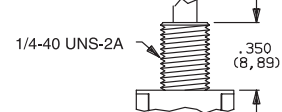
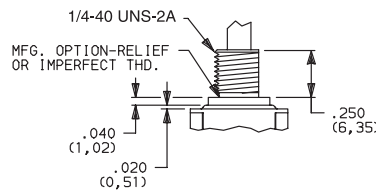
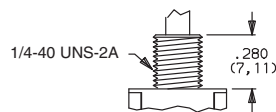
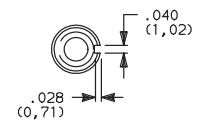
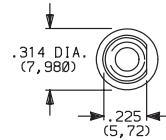
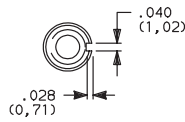

D9 bushing standard with A-A6, R, R2 AV-AV3 terminations.

H bushing standard with C, W-W4, Z or Z3 terminations. H, H9 bushings not available on single pole models with A3-A6, R, R2 terminations.

**Will withstand 12 in./lbs. of torque with no distortion.**



Dimensions are shown: Inches (mm)  
Specifications and dimensions subject to change



# 8020 Series Snap-acting Momentary Pushbutton Switches



A Pushbutton

## BUSHING

**Y3** 6.35mm THREADED, KEYWAY

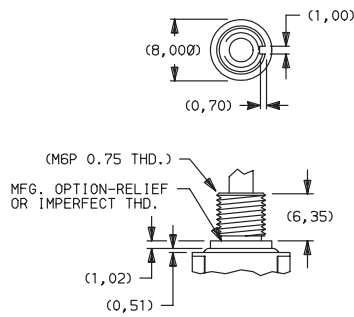

**Y4** .378" HIGH THREADED, FLAT

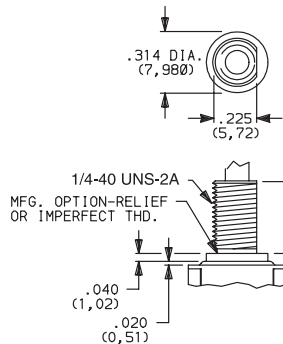

**D2** .288" HIGH THREADED, FLAT  
**D8** .288" HIGH UNTHREADED, FLAT

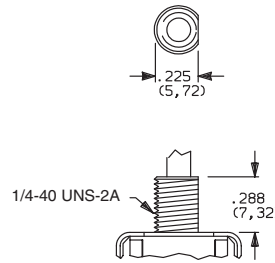

**D3** .180" HIGH UNTHREADED

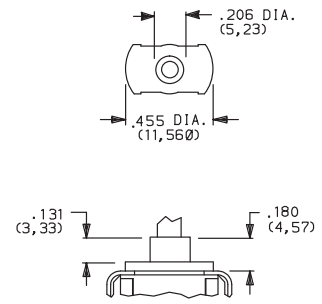

Y3 & Y4 bushings not available on single pole models with A3-A6, R, R2 terminations. Will withstand 12 in./lbs. of torque with no distortion.

D2, D8 bushings not available with C, W-W4, Z, Z3 terminations.

D3 bushing available with A, A2, A3, AV, AV2, AV3 and V2-V61 terminations only.

**NOTE:** No bushing option choice required when JXX actuator option is selected. When selecting bushing option, plunger selection must also be made, see previous page. Plunger lengths vary with bushing and termination options selected.

## PANEL MOUNTING

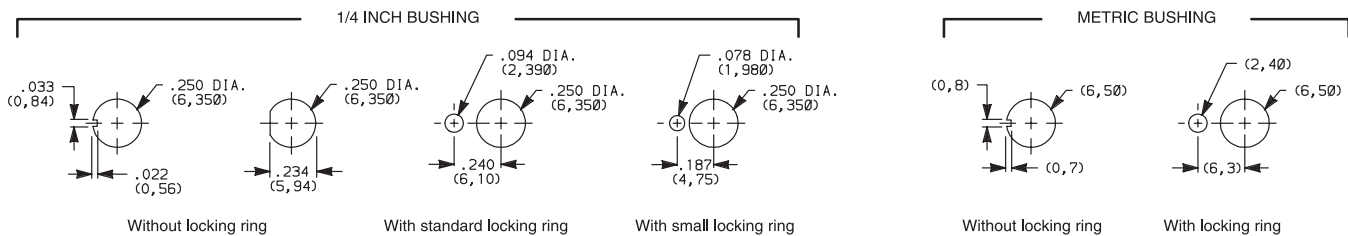

**NOTE:** Two mounting nuts, locking ring and lockwasher supplied standard with threaded bushings. Optional mounting nut and locking ring styles available, see section "Technical Data and Additional Hardware".

## TERMINATIONS

**Z** SOLDER LUG

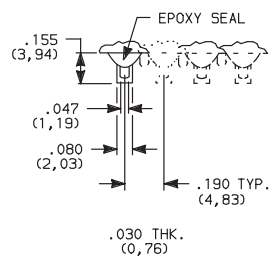

Not available with J95 actuator, P or R contact material.

SPDT thru 4PDT

**C** PC THRU-HOLE

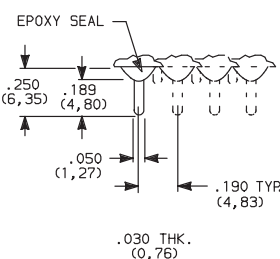

PC MOUNTING

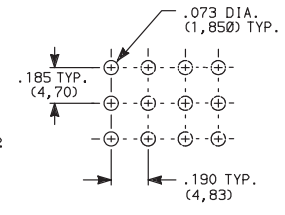

Not available with J95 actuator option.

SPDT thru 4PDT

**Z3** QUICK CONNECT

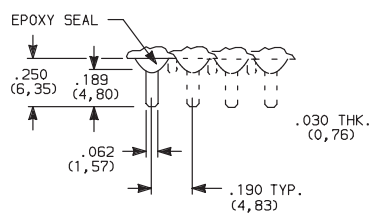

Not available with J95 actuator, P or R contact material. Mating quick connector available, order part number 530100000, page A-44.

SPDT thru 4PDT

**W W1, W3, W4** WIRE WRAP

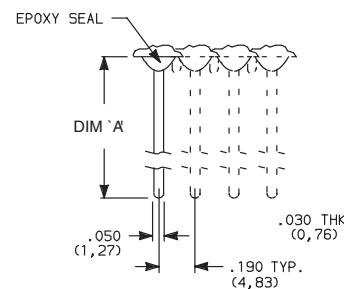

OPTION CODE	DIM 'A'
<b>W</b>	.750 (19,05)
<b>W1</b>	.964 (24,49)
<b>W3</b>	.425 (10,80)
<b>W4</b>	1.062 (26,97)

Not available with J95 actuator option.

SPDT thru 4PDT

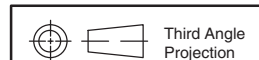

Third Angle Projection



Dimensions are shown: Inches (mm)  
Specifications and dimensions subject to change



# 8020 Series Snap-acting Momentary Pushbutton Switches

## TERMINATIONS



A

Pushbutton

**A** RIGHT ANGLE, PC THRU-HOLE



**8121SD9AGE  
SPDT**

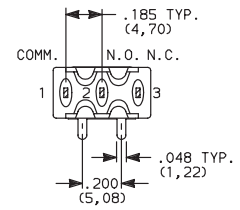
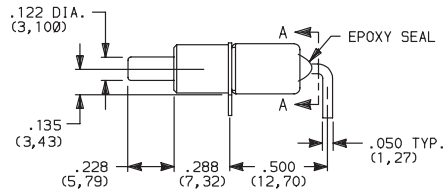
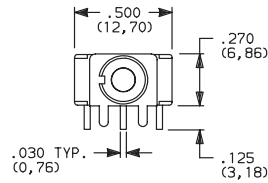

SECTION A-A

Terminal Nos.  
For Reference Only.

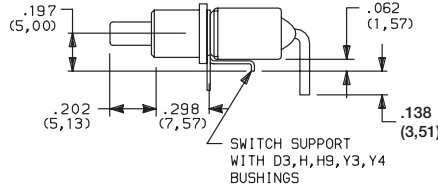

Part Number 8121SH9AGE

**A3** RIGHT ANGLE, SNAP-IN, PC THRU-HOLE

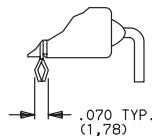
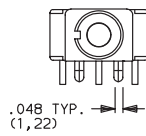

PC MOUNTING

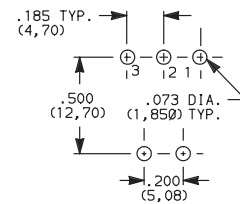

Not available with JXX actuators and I seal.  
Terminal bend radii and lead-in manufacturing option.

**A** RIGHT ANGLE, PC THRU-HOLE



**8221SD9AGE  
DPDT**

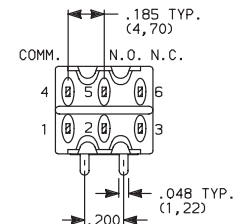
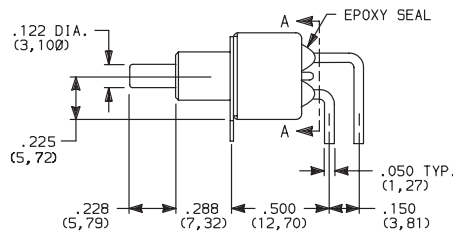
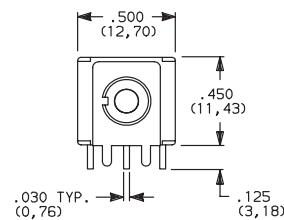

SECTION A-A

**A3** RIGHT ANGLE, SNAP-IN, PC THRU-HOLE

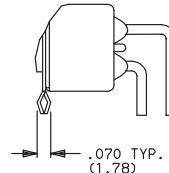
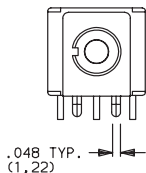

PC MOUNTING

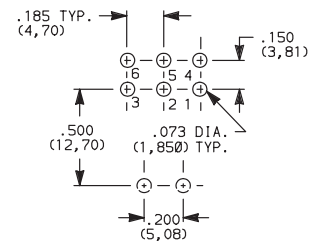

Not available with JXX actuators and I seal option.  
Terminal bend radii and lead-in manufacturing option.



Dimensions are shown: Inches (mm)  
Specifications and dimensions subject to change



# 8020 Series Snap-acting Momentary Pushbutton Switches



A

Pushbutton

## TERMINATIONS

### A RIGHT ANGLE, PC THRU-HOLE

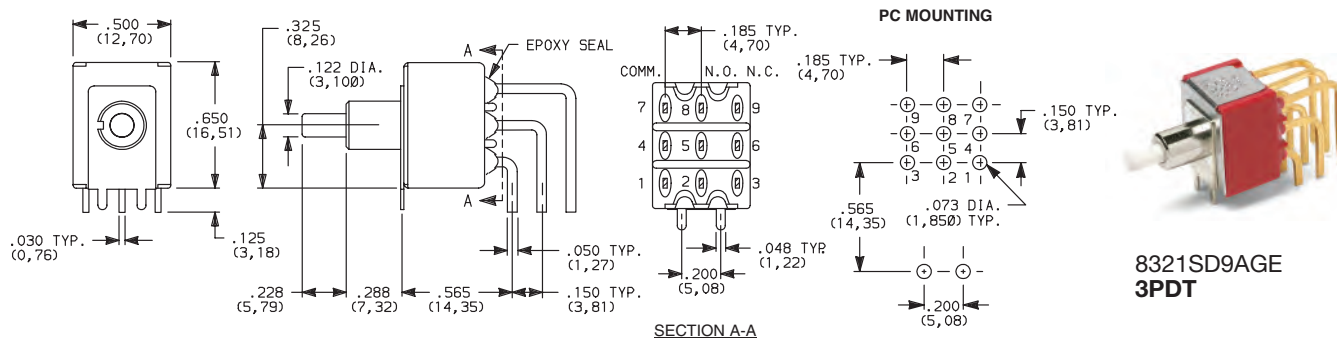

Not available with JXX actuators and I seal option.  
Terminal bend radii and lead-in manufacturing option.

### A2 RIGHT ANGLE, PC THRU-HOLE

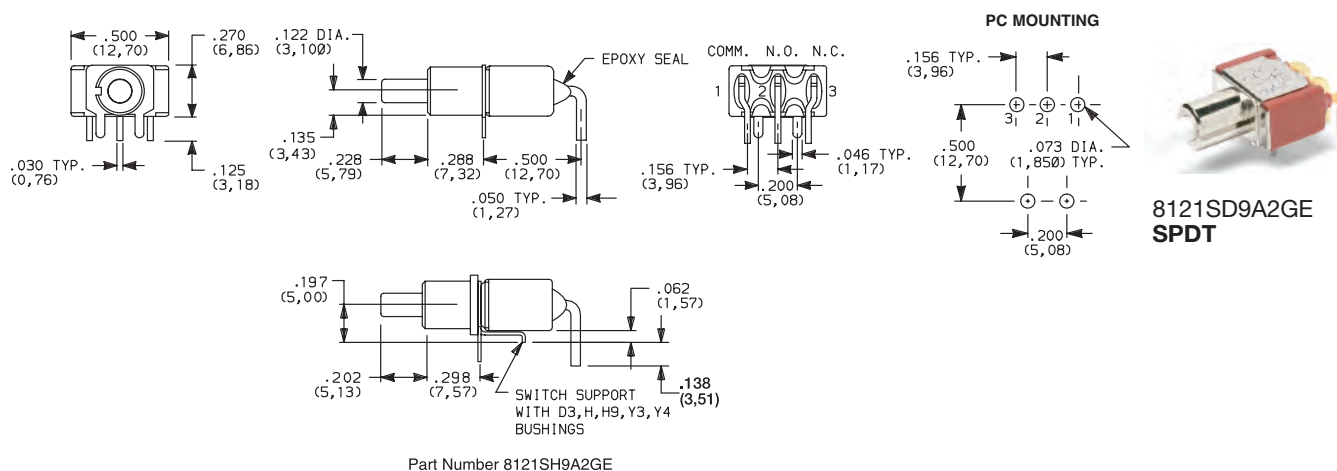

Part Number 8121SH9A2GE

Not available with JXX actuators, I seal option.  
Terminal bend radii and lead-in manufacturing option.

### A4 RIGHT ANGLE, PC THRU-HOLE, REVERSED TERMINALS

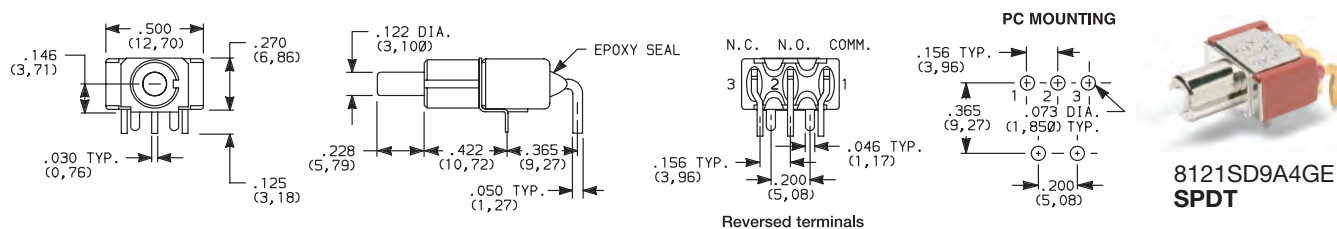

Reversed terminals

Not available with JXX actuators, D3, H, H9, Y3, Y4 bushings and I seal.  
Terminal bend radii and lead-in manufacturing option.

The A4 and R2 termination options are functionally identical and fit the same PC mounting pattern. The switches, however, are shifted relative to the mounting holes. The PC pattern must clear the switch support legs. Unlike the R2, the A4 option is available with UL/CSA.



Third Angle Projection



Dimensions are shown: Inches (mm)  
Specifications and dimensions subject to change



# 8020 Series Snap-acting Momentary Pushbutton Switches

## TERMINATIONS



A

Pushbutton

### A6 RIGHT ANGLE, PC THRU-HOLE



8121SD9A6GE  
SPDT

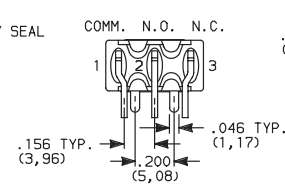
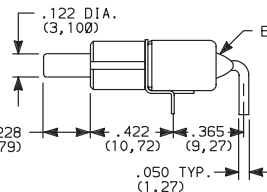
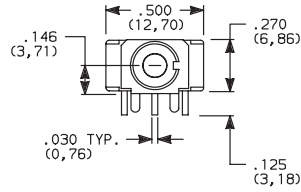

### PC MOUNTING

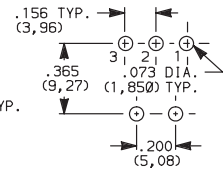

Not available with JXX actuators, D3, H, H9, Y3, Y4 bushings and I seal. Terminal bend radii and lead-in manufacturing option.

The A6 and R termination options are functionally identical and fit the same PC mounting pattern. The switches, however, are shifted relative to the mounting holes. The PC pattern must clear the switch support legs. Unlike the R, the A6 option is available with UL/CSA.

### R RIGHT ANGLE WITH PCB



8121SD9RGE  
SPDT

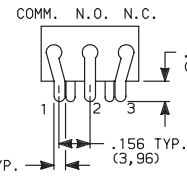
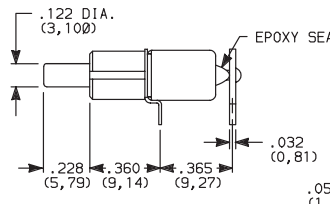
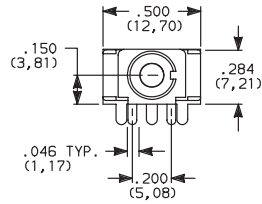

### PC MOUNTING

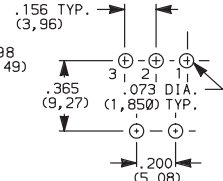

Not available with JXX actuators, D3, H, H9, Y3, Y4 bushings, I seal option. R termination not UL/CSA approved.

### R2 RIGHT ANGLE WITH PCB, REVERSED TERMINALS



8121SD9R2GE  
SPDT

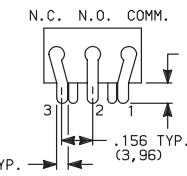
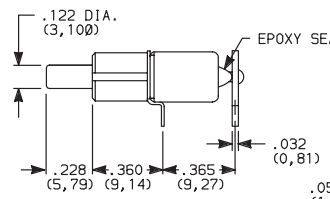
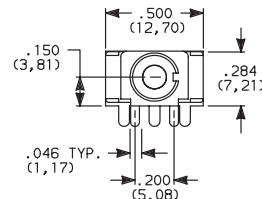

### PC MOUNTING

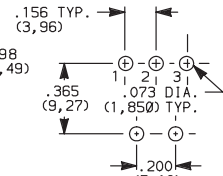

Reversed terminals

Not available with JXX actuators, D3, H, H9, Y3, Y4 bushings, I seal option. R2 termination not UL/CSA approved.

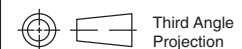

Dimensions are shown: Inches (mm)  
Specifications and dimensions subject to change

# 8020 Series Snap-acting Momentary Pushbutton Switches



A

Pushbutton

## TERMINATIONS

**AV2** VERTICAL RIGHT ANGLE, PC THRU-HOLE, .150" PITCH

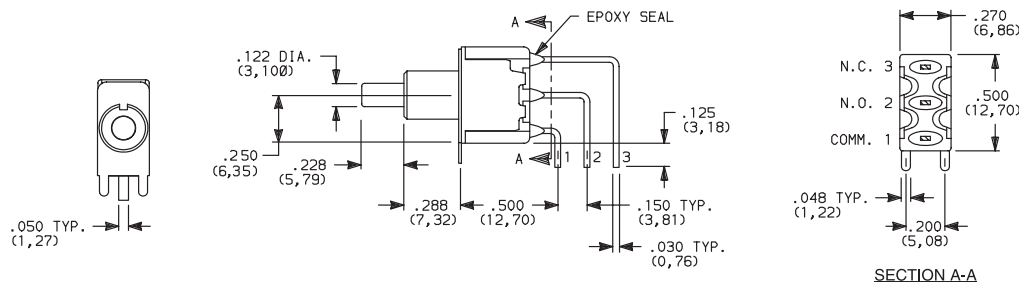

8121SD9AV2GE  
SPDT

**AV3** VERTICAL RIGHT ANGLE, SNAP-IN, PC THRU-HOLE, .150" PITCH

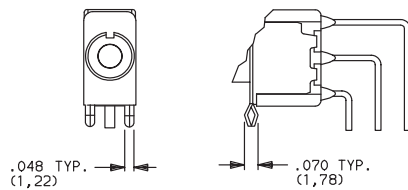

**AV1** VERTICAL RIGHT ANGLE, EXTENDED, PC THRU-HOLE, .150" PITCH

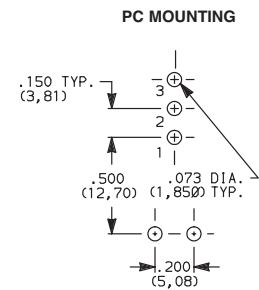
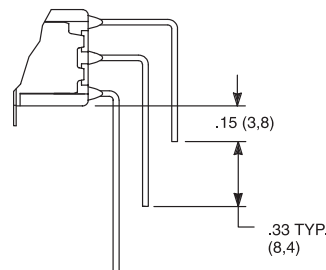

Not available with JXX actuators and I seal.  
Terminal bend radii and lead-in manufacturing option.

**AV2** VERTICAL RIGHT ANGLE, PC THRU-HOLE, .150" PITCH

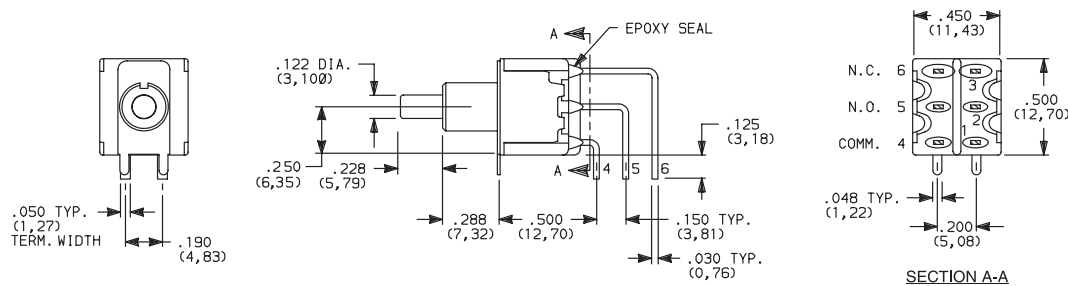

8221SD9AV2GE  
DPDT

**AV3** VERTICAL RIGHT ANGLE, SNAP-IN, PC THRU-HOLE, .150" PITCH

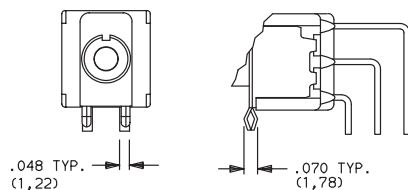

**AV1** VERTICAL RIGHT ANGLE, EXTENDED, PC THRU-HOLE, .150" PITCH

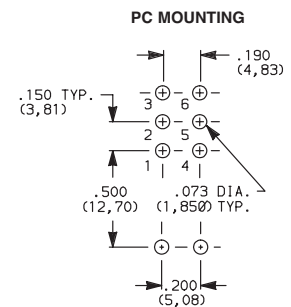
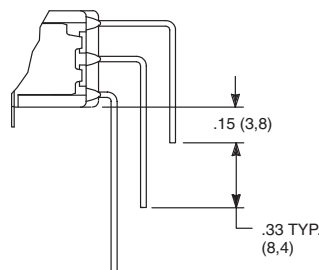

Not available with JXX actuators and I seal.  
Terminal bend radii and lead-in manufacturing option.



Third Angle Projection



Dimensions are shown: Inches (mm)  
Specifications and dimensions subject to change

www.ck-components.com



# 8020 Series Snap-acting Momentary Pushbutton Switches

## TERMINATIONS



Pushbutton  
A

**AV2** VERTICAL RIGHT ANGLE, PC THRU-HOLE, 150° PITCH



**8321SD9AV2GE**  
**3PDT**

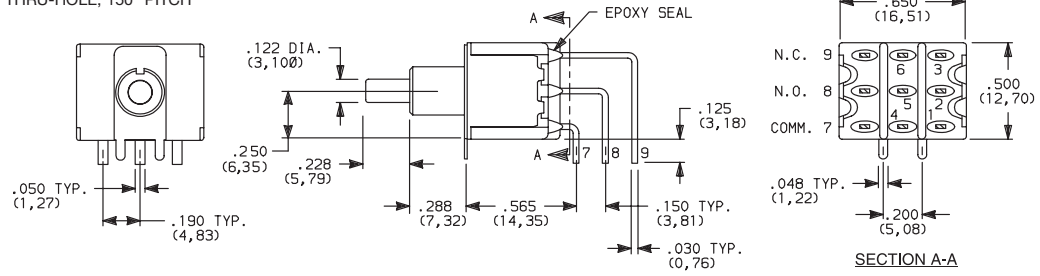

**AV3** VERTICAL RIGHT ANGLE, SNAP-IN, PC THRU-HOLE, .150° PITCH

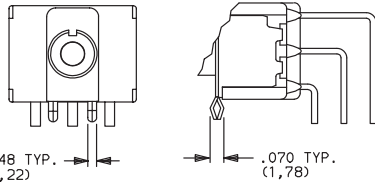

Not available with JXX actuators and I seal.  
Terminal bend radii and lead-in manufacturing option.

**AV1** VERTICAL RIGHT ANGLE, EXTENDED, PC THRU-HOLE, .150° PITCH

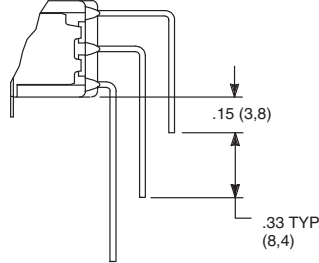

SECTION A-A

PC MOUNTING

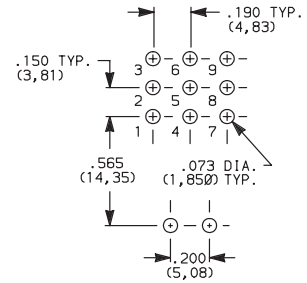

**AV2** VERTICAL RIGHT ANGLE, PC THRU-HOLE, 150° PITCH



**8421SD9AV2GE**  
**4PDT**

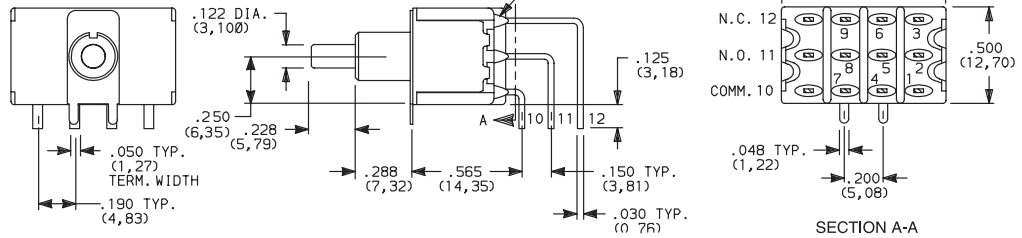

**AV3** VERTICAL RIGHT ANGLE, SNAP-IN, PC THRU-HOLE, .150° PITCH

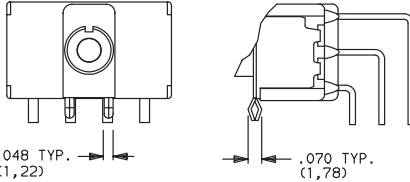

Not available with JXX actuators and I seal.  
Terminal bend radii and lead-in manufacturing option.

**AV1** VERTICAL RIGHT ANGLE, EXTENDED, PC THRU-HOLE, .150° PITCH

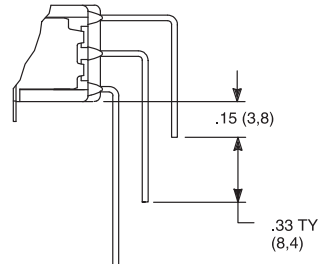

SECTION A-A

PC MOUNTING

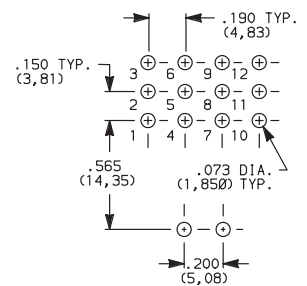

**V2, V6, V7, V8** VERTICAL MOUNT, V-BRACKET

**V61** VERTICAL MOUNT, V-BRACKET, SNAP-IN



**8121SD3\_GE**  
**SPDT**

Not available with JXX actuators and I seal.

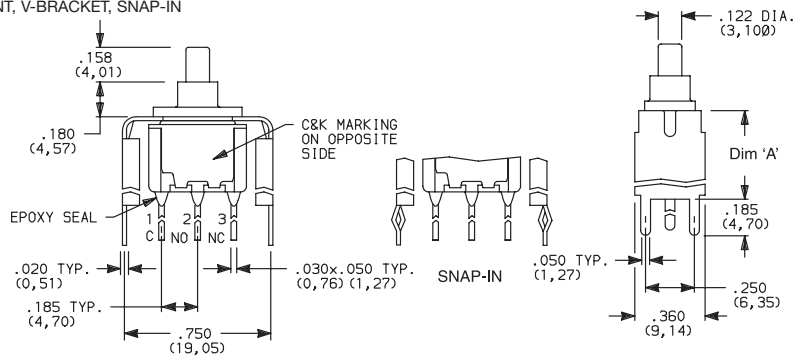

PC MOUNTING

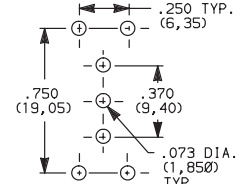

OPTION CODE	DIM 'A'
V2	.555 (14,10)
V6, V61	.460 (11,68)
V7	.630 (16,00)
V8	.953 (24,21)



Dimensions are shown: Inches (mm)  
Specifications and dimensions subject to change

# 8020 Series Snap-acting Momentary Pushbutton Switches



A

Pushbutton

## TERMINATIONS

**V2, V6, V7, V8** VERTICAL MOUNT, V-BRACKET

**V61** VERTICAL MOUNT, V-BRACKET, SNAP-IN

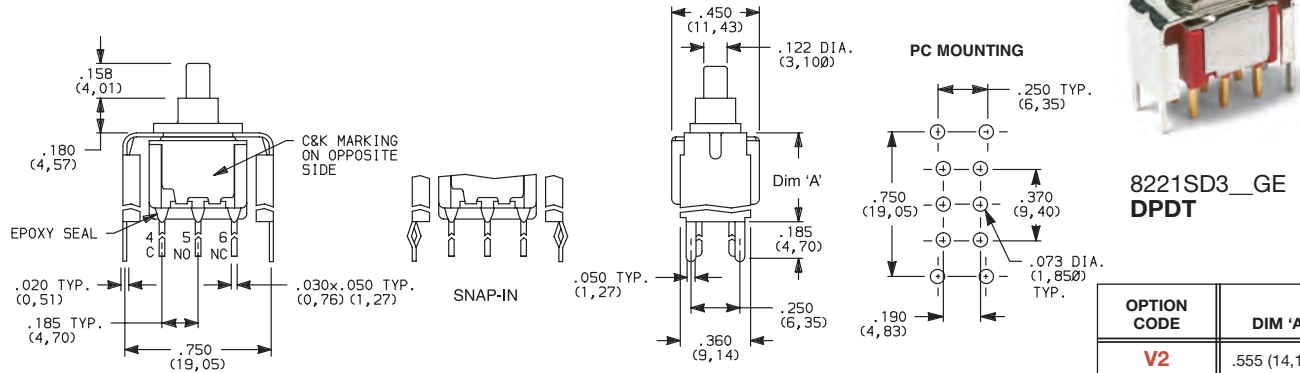

**8221SD3\_GE DPDT**

OPTION CODE	DIM 'A'
<b>V2</b>	.555 (14,10)
<b>V6, V61</b>	.460 (11,68)
<b>V7</b>	.630 (16,00)
<b>V8</b>	.953 (24,21)

Not available with JXX actuators and I seal.

**V2, V7, V8** VERTICAL MOUNT, V-BRACKET

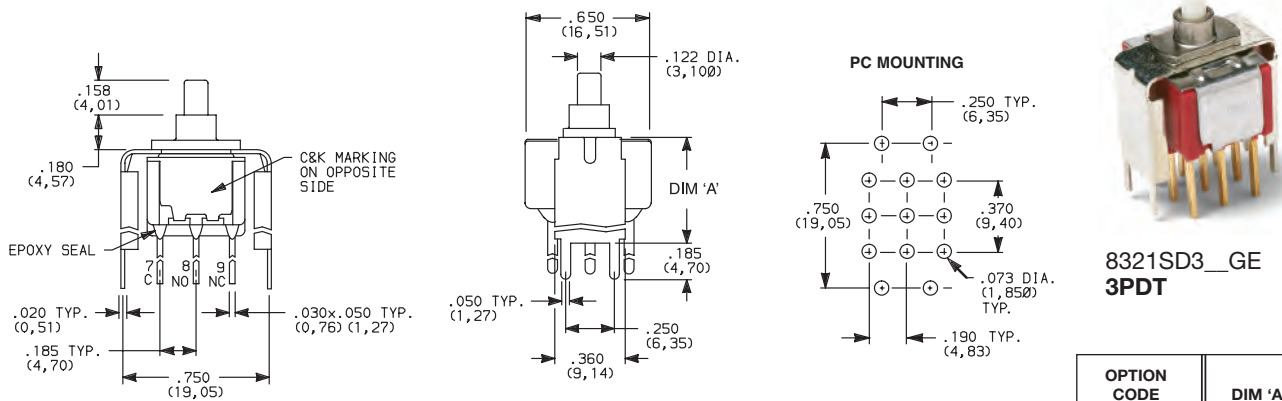

**8321SD3\_GE 3PDT**

OPTION CODE	DIM 'A'
<b>V2</b>	.555 (14,10)
<b>V7</b>	.630 (16,00)
<b>V8</b>	.953 (24,21)

Not available with JXX actuators and I seal.

**V2, V7, V8** VERTICAL MOUNT, V-BRACKET

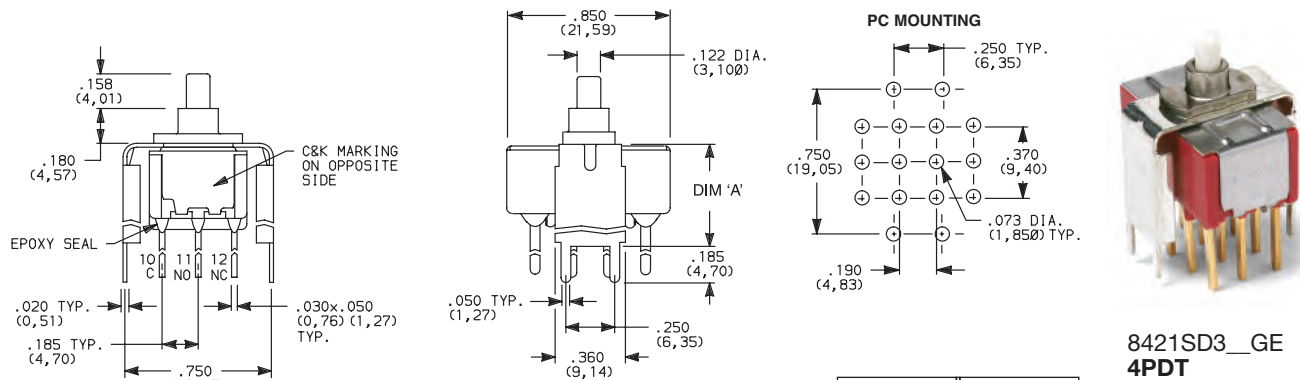

**8421SD3\_GE 4PDT**

OPTION CODE	DIM 'A'
<b>V2</b>	.555 (14,10)
<b>V7</b>	.630 (16,00)
<b>V8</b>	.953 (24,21)

Not available with JXX actuators and I seal.



Dimensions are shown: Inches (mm)  
Specifications and dimensions subject to change



# 8020 Series Snap-acting Momentary Pushbutton Switches

## TERMINATIONS



Pushbutton A

**V3, V4, V9** VERTICAL MOUNT, V-BRACKET

**V31** VERTICAL MOUNT, V-BRACKET, SNAP-IN



8121SD3\_GE  
SPDT

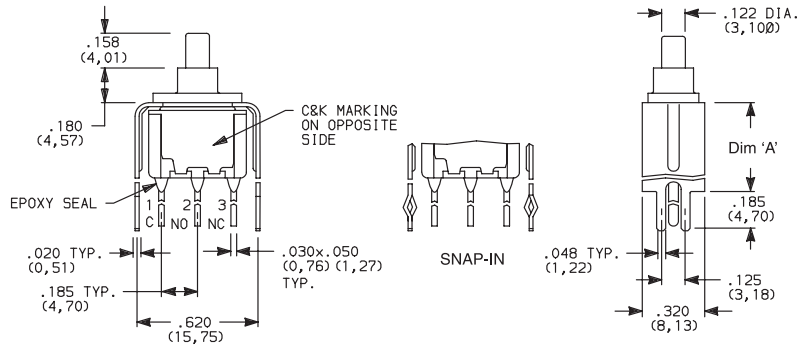

### PC MOUNTING

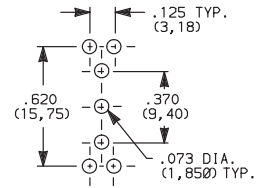

OPTION CODE	DIM 'A'
<b>V3, V31</b>	.460 (11,68)
<b>V4</b>	.630 (16,00)
<b>V9</b>	1.150 (29,21)

Not available with J8X actuators and I seal.

**V3, V4, V9** VERTICAL MOUNT, V-BRACKET

**V31** VERTICAL MOUNT, V-BRACKET, SNAP-IN



8221SD3\_GE  
DPDT

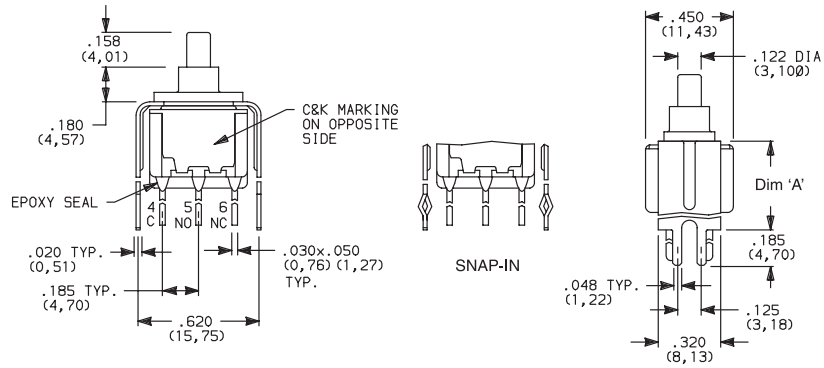

### PC MOUNTING

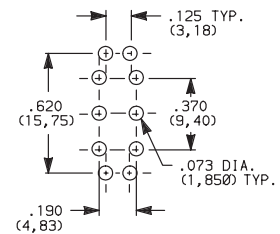

OPTION CODE	DIM 'A'
<b>V3, V31</b>	.460 (11,68)
<b>V4</b>	.630 (16,00)
<b>V9</b>	1.150 (29,21)

Not available with J8X actuators and I seal.

**V4, V9** VERTICAL MOUNT, V-BRACKET



8321SD3V4GE  
3PDT

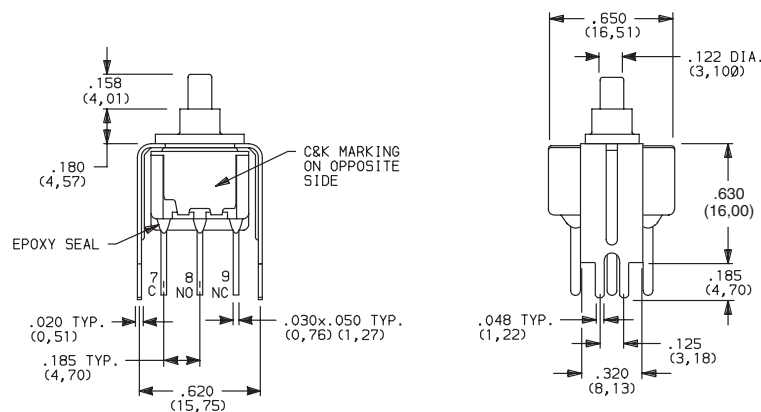

### PC MOUNTING

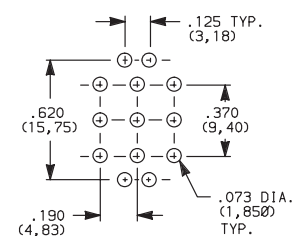

OPTION CODE	DIM 'A'
<b>V4</b>	.630 (16,00)
<b>V9</b>	1.150 (29,21)

Not available with JXX actuators and I seal.



Dimensions are shown: Inches (mm)  
Specifications and dimensions subject to change



# 8020 Series Snap-acting Momentary Pushbutton Switches



A

Pushbutton

## TERMINATIONS

**V4, V9** VERTICAL MOUNT, V-BRACKET

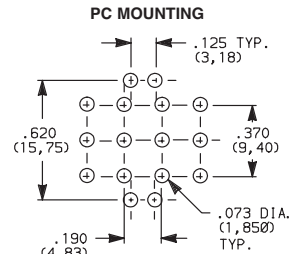
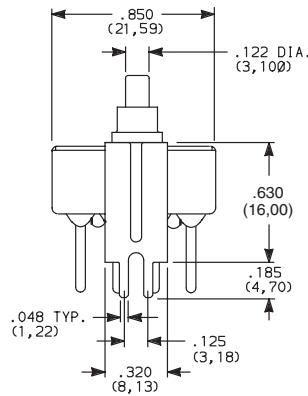
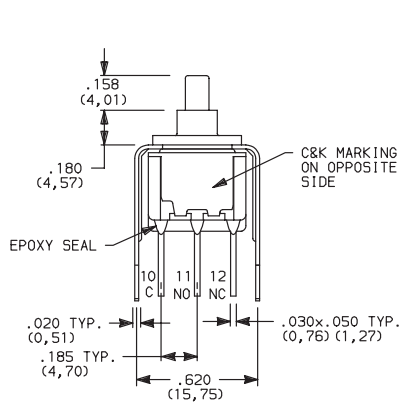

8421SD3V4GE  
4PDT

OPTION CODE	DIM 'A'
<b>V4</b>	.630 (16,00)
<b>V9</b>	1.150 (29,21)

Not available with JXX actuators and I seal.

## CONTACT MATERIAL

OPTION CODE	CONTACT MATERIAL	TERMINAL PLATING	RATINGS	
<b>B</b>	GOLD <sup>1</sup>	GOLD <sup>1</sup>	LOW LEVEL/DRY CIRCUIT	8x25 MODELS ONLY: 0.4 MAX. @ 20 V AC OR DC MAX.
<b>P</b>		MATTE-TIN <sup>4</sup>		
<b>G</b>	GOLD OVER SILVER <sup>2,3</sup>	GOLD <sup>3</sup>	LOW LEVEL/DRY CIRCUIT OR POWER	8X21, U8X1 MODELS ONLY: 0.4 VA MAX @ 20 V AC OR DC MAX. OR 1 AMP @ 120 V AC OR 28 V DC.
<b>R</b>		MATTE-TIN <sup>4</sup>		

\* Note: See Technical Data section of this catalog for RoHS compliant and compatible definitions and specifications.

- <sup>1</sup> ALL CONTACTS & TERMINALS: Copper alloy, with gold plate over nickel plate.
- <sup>2</sup> N.O. AND N.C. CONTACTS: Coin silver, with gold plate over nickel plate.
- <sup>3</sup> COMMON CONTACTS & ALL TERMINALS: Copper alloy, with gold plate over nickel plate.
- <sup>4</sup> TERMINALS: Copper alloy, with matte-tin over nickel plate.

**NOTE:** Any models supplied with B, P, R or G contact material are RoHS compliant.

U811-U841 models with all options (except R, R2 terminations) when ordered with mandatory G or R contact material.

B or P contact material must be ordered with 8X25 models.

G or R contact material must be ordered with 8X21, U8X1 models.

P or R contact material not available with Z, Z3 terminations.

## SEAL

**E** EPOXY SEAL

**I** EPOXY POTTED BASE

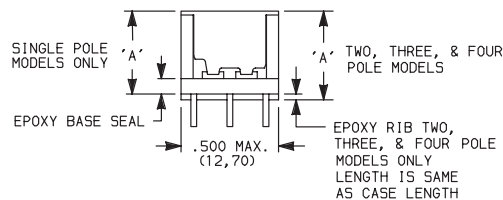
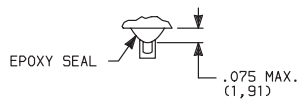

NO. POLES	DIM 'A'
SP	.410 (10,41)
DP	.440 (11,18)
3P	.505 (12,83)
4P	.505 (12,83)

**NOTE:** Available with C, W-W4, Z, Z3 terminations only.



Third Angle Projection



Dimensions are shown: Inches (mm)  
Specifications and dimensions subject to change

www.ck-components.com





# 8020 Series Snap-acting Momentary Pushbutton Switches

Pushbutton  
A

## AVAILABLE HARDWARE

Cap

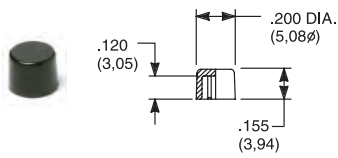

**PART NO.**

- 708901000 WHITE
- 708902000 BLACK
- 708903000 RED
- 708904000 ORANGE
- 708905000 YELLOW
- 708906000 GREEN
- 708907000 BLUE
- 708909000 GRAY

Material: Nylon  
Finish: Gloss

Cap

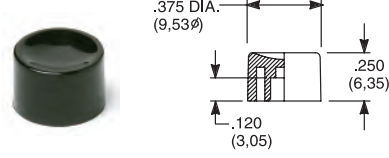

**PART NO.**

- 752701000 WHITE
- 752702000 BLACK
- 752703000 RED
- 752704000 ORANGE
- 752705000 YELLOW
- 752706000 GREEN
- 752707000 BLUE
- 752709000 GRAY

Material: Nylon  
Finish: Gloss

Cap

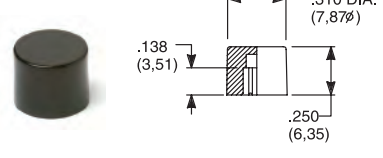

**PART NO.**

- 801801000 WHITE
- 801802000 BLACK
- 801803000 RED
- 801804000 ORANGE
- 801805000 YELLOW
- 801806000 GREEN
- 801807000 BLUE
- 801809000 GRAY

Material: Nylon  
Finish: Gloss

Cap, Snap-fitting plunger

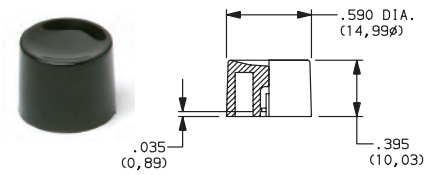

**PART NO.**

- 452D01000 WHITE
- 452D02000 BLACK
- 452D03000 RED
- 452D04000 ORANGE
- 452D05000 YELLOW
- 452D06000 GREEN
- 452D07000 BLUE
- 452D09000 GRAY

Material: Nylon  
Finish: Gloss

Cap, Snap-fitting plunger

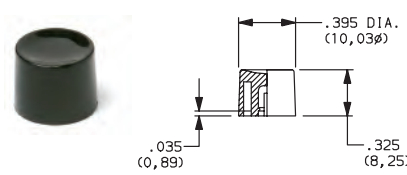

**PART NO.**

- 894101000 WHITE
- 894102000 BLACK
- 894103000 RED
- 894104000 ORANGE
- 894105000 YELLOW
- 894106000 GREEN
- 894107000 BLUE
- 894109000 GRAY

Material: Nylon  
Finish: Gloss

Cap, J80, J81, J82, J83 & J84 options only

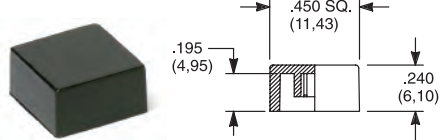

**PART NO.**

- 484601000 WHITE
- 484602000 BLACK
- 484603000 RED
- 484604000 ORANGE
- 484605000 YELLOW
- 484606000 GREEN
- 484607000 BLUE
- 484609000 GRAY

Material: Nylon  
Finish: Gloss

**PART NO.**

- 798201000 WHITE
- 798202263 BLACK
- 798203000 RED
- 798204000 ORANGE
- 798205000 YELLOW
- 798206000 GREEN
- 798207000 BLUE
- 798209000 GRAY

Material: Nylon  
Finish: Matte

Frame



**PART NO.**

- 615602263 BLACK

Material: Nylon  
Finish: Matte

Frame



**PART NO.**

- 613302263 BLACK

Material: Nylon  
Finish: Matte

Cap, J85 & J95 options only

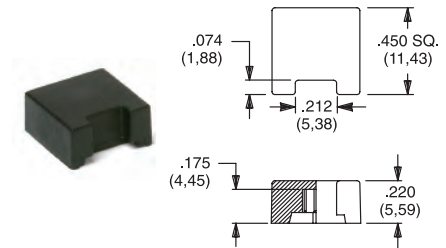

**PART NO.**

- 459701000 WHITE
- 459702000 BLACK
- 459703000 RED
- 459704000 ORANGE
- 459705000 YELLOW
- 459706000 GREEN
- 459707000 BLUE
- 459709000 GRAY

Material: Nylon  
Finish: Gloss

**PART NO.**

- 476801000 WHITE
- 476802000 BLACK
- 476803000 RED
- 476804000 ORANGE
- 476805000 YELLOW
- 476806000 GREEN
- 476807000 BLUE
- 476809000 GRAY

Material: Nylon  
Finish: Matte

Fits Z3 Termination female connector



**PART NO.**

- 530100000

Available in loose pieces.

NOTE: Additional nuts, locking rings and lockwashers available separately, see section "Technical Data and Additional Hardware".  
Other cap & frame colors available, consult Customer Service Center.



Dimensions are shown: Inches (mm)  
Specifications and dimensions subject to change



# 8020 Series Snap-acting Momentary Pushbutton Switches



A Pushbutton

## AVAILABLE HARDWARE

Frames snap into panel opening and are independent from switch mounting. Accurate positioning of the PC mounted switch relative to the panel opening is necessary to provide proper clearance between actuator and frame. Available in two basic styles and four panel thicknesses .047-.125 in. Material: Nylon. Finish: Matte.

### TYPICAL APPLICATION

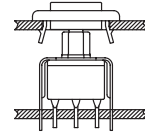

.047" (1,19) PANEL THK.	.062" (1,57) PANEL THK.	.090" (2,29) PANEL THK.	.125" (3,18) PANEL THK.
<b>PART NO.</b> 432502263	<b>PART NO.</b> 432602263	<b>PART NO.</b> 432702263	<b>PART NO.</b> 432802263 BLACK

### PANEL MOUNTING

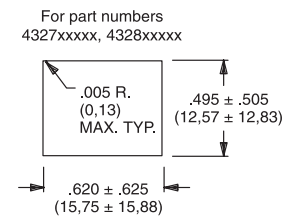
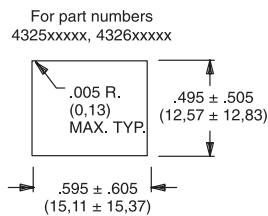

### Panel Inserts

Above frames (part nos. 432XXXXXX) are also available with insert which accepts LED for indicator light assembly. Order insert separately from frame. Blank insert panel (without hole for LED) also available. **LED not included.**

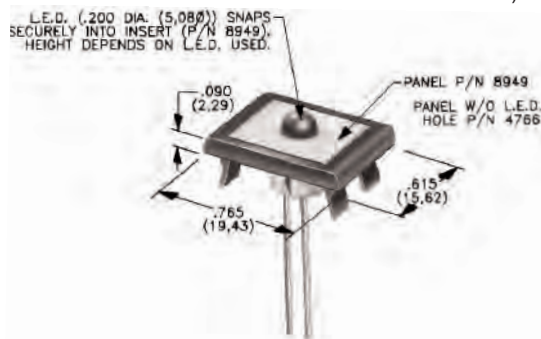

PANEL INSERT WITH HOLE FOR LED

**PART NO.**  
894902000

BLANK PANEL INSERT WITHOUT HOLE FOR LED

**PART NO.**  
476602000 BLACK

Special colors, custom markings available, consult Customer Service Center.

### LED INFORMATION

SWITCHES WITH LED SUPPLIED: J85, J95 OPTIONS:

Rectangular LEDs are supplied on 8020 Series pushbutton switches with J85 and J95 options. These LEDs are factory installed and are not replaceable. The following specifications apply:

OPTION CODE	COLOR	TYP. INTENSITY	TYP. FORWARD VOLTAGE	TYP. FORWARD CURRENT	MAX RATINGS AT 25°C AMBIENT TEMPERATURE		
					FORWARD VOLTAGE	CONTINUOUS FORWARD CURRENT	POWER DISSIPATION
6	Green	1.0 mcd	2.1 V	20 mA	2.5 V	50 mA	125 mW
3	Red*	0.5 mcd		10 mA		30 mA	75 mW
5	Yellow	4.0 mcd		20 mA		50 mA	125 mW

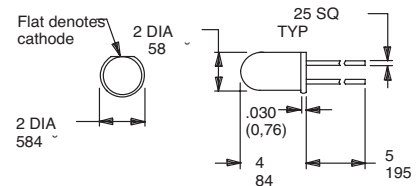

Suggested LED for J82 & J84 options  
Dimensions for reference only

**Process Information:** Soldering to LED leads must be completed within 5 seconds at 500°F (260°C) maximum.

**Caution:** Circuit elements must limit forward current of LED to 50mA max. continuous.  
\* Extra-bright red LED available (typ. intensity 4.5 mcd), consult Customer Service Center.  
LEDs are not supplied with J82, J84 options. LED snaps into switch frame surrounding actuator and is wired externally.

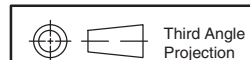

Dimensions are shown: Inches (mm)  
Specifications and dimensions subject to change





Компания «ЭлектроПласт» предлагает заключение долгосрочных отношений при поставках импортных электронных компонентов на взаимовыгодных условиях!

Наши преимущества:

- Оперативные поставки широкого спектра электронных компонентов отечественного и импортного производства напрямую от производителей и с крупнейших мировых складов;
- Поставка более 17-ти миллионов наименований электронных компонентов;
- Поставка сложных, дефицитных, либо снятых с производства позиций;
- Оперативные сроки поставки под заказ (от 5 рабочих дней);
- Экспресс доставка в любую точку России;
- Техническая поддержка проекта, помощь в подборе аналогов, поставка прототипов;
- Система менеджмента качества сертифицирована по Международному стандарту ISO 9001;
- Лицензия ФСБ на осуществление работ с использованием сведений, составляющих государственную тайну;
- Поставка специализированных компонентов (Xilinx, Altera, Analog Devices, Intersil, Interpoint, Microsemi, Aeroflex, Peregrine, Syfer, Eurofarad, Texas Instrument, Miteq, Cobham, E2V, MA-COM, Hittite, Mini-Circuits, General Dynamics и др.);

Помимо этого, одним из направлений компании «ЭлектроПласт» является направление «Источники питания». Мы предлагаем Вам помощь Конструкторского отдела:

- Подбор оптимального решения, техническое обоснование при выборе компонента;
- Подбор аналогов;
- Консультации по применению компонента;
- Поставка образцов и прототипов;
- Техническая поддержка проекта;
- Защита от снятия компонента с производства.



#### Как с нами связаться

**Телефон:** 8 (812) 309 58 32 (многоканальный)

**Факс:** 8 (812) 320-02-42

**Электронная почта:** [org@eplast1.ru](mailto:org@eplast1.ru)

**Адрес:** 198099, г. Санкт-Петербург, ул. Калинина, дом 2, корпус 4, литера А.