



FEATURES

- Input voltage range: 36V~75V
- Output voltage range (trim and PMBUS) 8V~13.2V
- Fully regulated from 36 to 75Vin
- High efficiency : 95.0% @ 48Vin/42A
- Size: 58.4mm x 36.8mm x 12.7mm (2.3" x 1.45" x 0.50")
- Industry standard DOSA compliant pin out
- Fully protected: Input UVLO, Output OCP and OVP, OTP
- Droop current sharing
- 1500V isolation
- No minimum load required
- Fixed frequency operation
- ISO 9001, TL 9000, ISO 14001, QS9000, OHSAS18001 certified manufacturing facility
- UL/CUL 60950-1 (US & Canada)

Delphi Series Q48SC12042, Quarter Brick Family DC/DC Power Modules: 36~75Vin, 12Vout, 500W

The Delphi series Q48SC12042, quarter brick, 36~75V input, single output 12V, are full digital control DC/DC converter, and are the latest offering from a world leader in power system and technology and manufacturing — Delta Electronics, Inc. This product provides up to 500 watts of power at 36~75V input in an industry standard, DOSA compliant footprint and pin out. The Q48SC12042 offers more than 95.0% high efficiency at 48V input, 12V output and 42A load. There is a built-in digital PWM controller in the Q48SC12042 series, which is used to complete the Vo feedback, PWM signal generation, droop or active current sharing, fault protection, output voltage trim, on/off control and PMBUS communications, and so on. With the digital control, many design and application flexibility, advanced performance, and reliability are obtained. The Q48SC12042 can be connected in parallel directly for higher power without adding external oring-fet.

OPTIONS

- Positive or Negative On/Off logic
- Droop current sharing
- Digital pins

APPLICATIONS

- Datacom / Networking
- Wireless networks
- Optical network equipment
- Server and data storage
- Industrial / Test equipment

TECHNICAL SPECIFICATIONS

($T_A=25^{\circ}\text{C}$, airflow rate=400 LFM, $V_{in}=48\text{Vdc}$, nominal V_{out} unless otherwise noted.)

| PARAMETER | NOTES and CONDITIONS | Q48SC12042 | | | |
|--|---|------------|------|----------|--------------------|
| | | Min. | Typ. | Max. | Units |
| ABSOLUTE MAXIMUM RATINGS | | | | | |
| Input Voltage | | | | | |
| Continuous | | 0 | | 75 | Vdc |
| Transient (100ms) | 100ms | | | 100 | Vdc |
| On/off Pin Voltage | | -50 | | 50 | V |
| Other Pin Voltage | Trim/Current Sharing, C2, Data, SMBAlert, Clock, Addr1, Addr0 | -0.3 | | 3.6 | V |
| Output negative voltage | | | | 0.3 | V |
| Operating ambient Temperature | | -40 | | 85 | $^{\circ}\text{C}$ |
| Storage Temperature | | -55 | | 125 | $^{\circ}\text{C}$ |
| Input/Output Isolation Voltage | | | | 1500 | Vdc |
| INPUT CHARACTERISTICS | | | | | |
| Operating Input Voltage | | 36 | 48 | 75 | Vdc |
| Input Under-Voltage Lockout | | | | | |
| Turn-On Voltage Threshold (Adjustable via PMBus, VIN_ON) | | 34 | | 36 | Vdc |
| Turn-Off Voltage Threshold (Adjustable via PMBus, VIN_OFF) | | 31 | | 34 | Vdc |
| Lockout Hysteresis Voltage | | | 2 | | Vdc |
| Maximum Input Current | $V_{in}=36\text{V}$, 100% Load | | | 17.5 | A |
| No-Load Input Current | $V_{in}=48\text{V}$ | 80 | 110 | 140 | mA |
| Off Converter Input Current | $V_{in}=48\text{V}$ | 10 | 18 | 26 | mA |
| Input Capacitance | | 100 | | | μF |
| Inrush Current (I^t) | | | | 1 | A2S |
| Input Reflected-Ripple Current | P-P thru 12 μH inductor, 5Hz to 20MHz | | 60 | | mA |
| Input Voltage Ripple Rejection | 120Hz | | 50 | | dB |
| OUTPUT CHARACTERISTICS | | | | | |
| The module without droop current sharing option code | | | | | |
| Output Voltage Set Point (Adjustable via PMBus) | $V_{in}=48\text{V}$, $I_o=0\text{A}$, $T_a=25^{\circ}\text{C}$ | 11.88 | 12 | 12.12 | Vdc |
| Output Voltage Regulation | | | | | |
| Over Line | $V_{in}=36\text{V}$ to 75V, $I_o=100\%$ load | | | ± 40 | mV |
| Over Load | $V_{in}=36\text{V}$ to 75V, $I_o=I_{o,min}$ to $I_{o,max}$ | | | ± 40 | mV |
| Over temperature | $V_{in}=36\text{V}$ to 75V, $I_o=100\%$ load, $T_a=-40\text{C}$ to 85C | | | | mV |
| The module with droop current sharing option code | | | | | |
| Output Voltage Set Point (Adjustable via PMBus) | $V_{in}=48\text{V}$, $I_o=0\text{A}$, $T_a=25^{\circ}\text{C}$ | 12.28 | 12.4 | 12.52 | Vdc |
| Output Voltage Regulation | | | | | |
| Over Line | $V_{in}=36\text{V}$ to 75V, $I_o=100\%$ load | | | ± 40 | mV |
| Over Load | $V_{in}=36\text{V}$ to 75V, $I_o=I_{o,min}$ to $I_{o,max}$ | -750 | -500 | | mV |
| Over temperature | $V_{in}=36\text{V}$ to 75V, $I_o=100\%$ load, $T_a=-40\text{C}$ to 85C | | | | mV |
| Both with and without droop current sharing option code | | | | | |
| Output Voltage Trim and PMBUS Range | $V_{in}=36\text{V}$ to 75V, $P_{out} \leq \text{max rated power}$, $I_o \leq I_{o,max}$ | -33.3 | | 10 | % |
| Output Voltage Remote Sense Range (note 2) | $V_{in}=36\text{V}$ to 75V, $P_{out} \leq \text{max rated power}$, $I_o \leq I_{o,max}$ | 5.8 | | 10 | % |
| Output Over-Voltage Lockout (Adjustable via PMBus, VOUT_OV_FAULT_LIMIT) | | | 15.2 | | Vdc |
| Operating Output Current Range | Full input voltage range | 0 | | 42 | A |
| Output DC Current-Limit Inception | | 115 | | 135 | % |
| Output Capacitance | | 300 | | 15000 | μF |
| Output Voltage Ripple and Noise | $V_{in}=48\text{V}$, Full load, 20MHz bandwidth | | | | |
| Peak-to-Peak | $C_o=300\mu\text{F}/16\text{V}$ (polymer) + 10 $\mu\text{F}/16\text{V}$ (Tantalum Capacitor) + 1 $\mu\text{F}/16\text{V}$ (Ceramic) | | 75 | 110 | mV |
| RMS | $C_o=300\mu\text{F}/16\text{V}$ (polymer) + 10 $\mu\text{F}/16\text{V}$ (Tantalum Capacitor) + 1 $\mu\text{F}/16\text{V}$ (Ceramic) | | 22 | 32 | mV |
| DYNAMIC CHARACTERISTICS | | | | | |
| Output Voltage Current Transient | $V_{in}=48\text{V}$, Load Slew rate 0.1A/ μs with a 1 μF ceramic, a 10 μF tantalum, and a 300 μF polymer capacitor | | | | |
| Positive Step Change in Output Current | 50% $I_{o,max}$ to 75% $I_{o,max}$ | | 350 | 500 | mV |
| Negative Step Change in Output Current | 75% $I_{o,max}$ to 50% $I_{o,max}$ | -500 | -350 | | mV |
| Settling Time (within 1% V_{out} nominal) | | | 500 | | μs |
| Turn-On Transient (Adjustable via PMBus) | | | | | |
| Start-Up Time, From On/Off Control | From On/off to 90% V_o final value | | 55 | | ms |
| Start-Up Time, From Input | From Input to 90% V_o final value | | 75 | | ms |
| Output voltage Rise Time | From 10% V_o final value to 90% V_o final value | | 30 | | ms |
| EFFICIENCY | | | | | |
| 100% Load | $V_{in}=48\text{V}$ | | 95.0 | | % |
| 60% Load | $V_{in}=48\text{V}$ | | 96.0 | | % |
| ISOLATION CHARACTERISTICS | | | | | |
| Input to Output | | | | 1500 | Vdc |
| Isolation Resistance | | 10 | | | M Ω |
| Isolation Capacitance | | | 6800 | | pF |

TECHNICAL SPECIFICATIONS

($T_A=25^{\circ}\text{C}$, airflow rate=400 LFM, $V_{in}=48\text{Vdc}$, nominal V_{out} unless otherwise noted.)

| PARAMETER | NOTES and CONDITIONS | Q48SC12042 | | | |
|--|---|------------|------|------|--------------------|
| | | Min. | Typ. | Max. | Units |
| FEATURE CHARACTERISTICS | | | | | |
| Switching Frequency | | | 130 | | KHz |
| ON/OFF Control, Positive Remote On/Off logic | | | | | |
| Logic Low (Module On) | Von/off at Ion/off=1.0mA | -0.7 | | 0.8 | V |
| Logic High (Module Off) | Von/off at Ion/off=0.0 μA | 3.5 | | 50 | V |
| ON/OFF Current (for both remote on/off logic) | Ion/off at Von/off=0.0V | | | 0.5 | mA |
| GENERAL SPECIFICATIONS | | | | | |
| MTBF | Io=80% of Io max; $T_a=25^{\circ}\text{C}$; Airflow=300LFM | | 2.2 | | M |
| Weight | | | 65 | | grams |
| Over-Temperature Shutdown (With heat spreader) | Refer to Figure 21 for Hot spot location (48Vin,80% Io, 200LFM,Airflow from Vin+ to Vin-) | | 115 | | $^{\circ}\text{C}$ |
| Over-Temperature Shutdown (NTC resistor) | | | 125 | | $^{\circ}\text{C}$ |
| Note1: Please attach thermocouple on NTC resistor to test OTP function, the hot spots' temperature is just for reference. And the OTP is Adjustable via PMBus. | | | | | |
| Note2: Output voltage range 5.8% for remote sense-; Output voltage range 10% for remote sense+. | | | | | |

DIGITAL INTERFACE SPECIFICATIONS

($T_A=25^{\circ}\text{C}$, airflow rate=400 LFM, $V_{in}=48\text{Vdc}$, nominal V_{out} unless otherwise noted.)

| PARAMETER | NOTES and CONDITIONS | Q48SC12042 | | | |
|--|----------------------|------------|------------|------|--------------------|
| | | Min. | Typ. | Max. | Units |
| PMBUS SIGNAL INTERFACE CHARACTERISTICS | | | | | |
| Input High Voltage (CLK, DATA) | | 2.1 | | 3.3 | Vdc |
| Input Low Voltage (CLK, DATA) | | 0 | | 0.8 | Vdc |
| Input high level current (CLK, DATA) | | -10 | | 10 | μA |
| Input low level current (CLK, DATA) | | -10 | | 10 | μA |
| Output Low Voltage (SMBALERT#) | IOUT=2mA | | | 0.4 | Vdc |
| Output high level open drain leakage current (SMBALERT#) | VOU=3.6V | 0 | | 10 | μA |
| PMBus Operating frequency range | | | 100 or 400 | | kHz |
| Measurement System Characteristics | | | | | |
| Output current reading accuracy | 10.5A<IOUT<42A | -5 | 1.4 | 3 | % |
| | 1A<IOUT<10.5A | -1.7 | | 2.5 | A |
| VOU reading accuracy | | | 1 | | % |
| VIN reading accuracy | | -2 | | +2 | Vdc |
| Temperature sense range | | 0 | | | $^{\circ}\text{C}$ |
| Temperature reading accuracy | | -5 | | +5 | $^{\circ}\text{C}$ |

PIN DEFINATION

| Pin# | Name | Function | Pin# | Name | Function |
|------|----------|----------------------------|------|----------|--|
| 1 | VIN(+) | | 9 | VOUT(+) | |
| 2 | ON/OFF | Primary on/off control pin | 10 | C2 | PGOOD pin, and this pin also could be configured as secondary on/off control pin |
| 3 | Case | | 11 | SIG_GND | Signal ground |
| 4 | VIN(-) | | 12 | DATA | PMBus data line |
| 5 | VOUT(-) | | 13 | SMBALERT | PMBus SMBAlert line |
| 6 | SENSE(-) | Remote sense | 14 | CLOCK | PMBus clock line |
| 7 | TRIM | Trim ^{note 1} | 15 | ADDR1 | ADDR1 pin sets the high order digit of the address. |
| 8 | SENSE(+) | Remote sense | 16 | ADDR0 | ADDR0 pin sets the low order digit of the address. |

Note1: see the page 24.

SIMPLIFIED APPLICATION CIRCUIT



ELECTRICAL CHARACTERISTICS CURVES

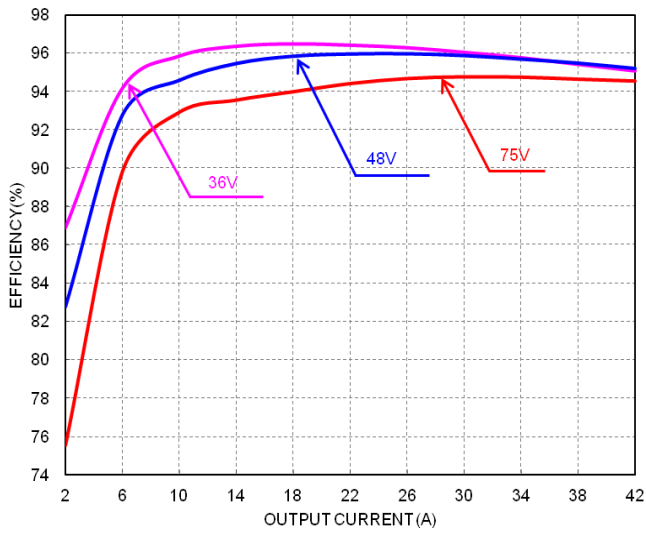

Figure 1: Efficiency vs. load current for minimum, nominal, and maximum input voltage at 25°C.

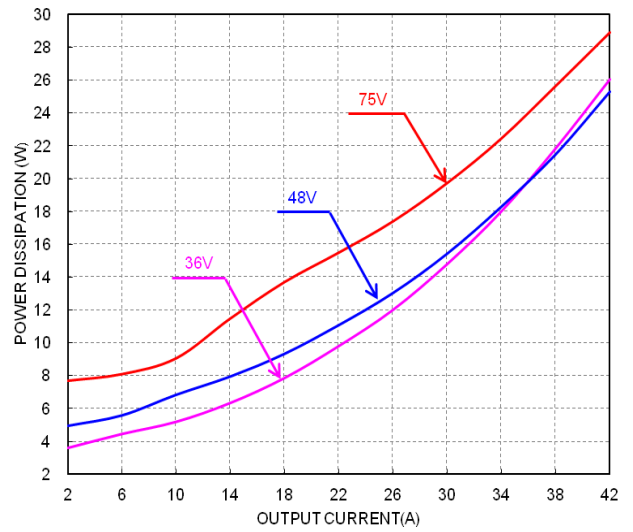

Figure 2: Power loss vs. load current for minimum, nominal, and maximum input voltage at 25°C.

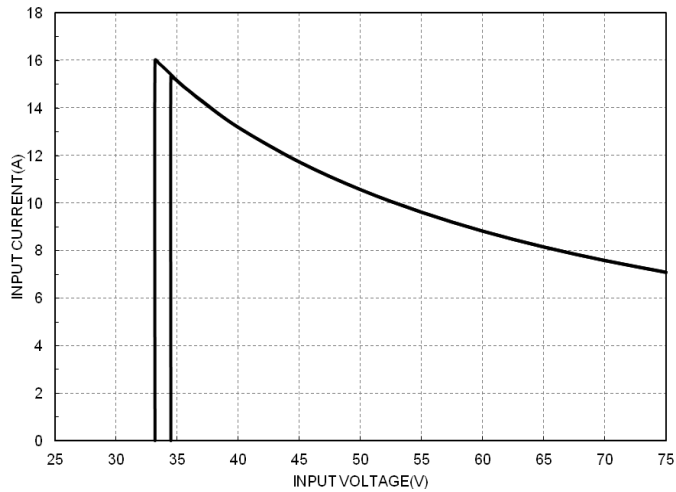

Figure 3: Typical full load input characteristics at room temperature.

ELECTRICAL CHARACTERISTICS CURVES

For Negative Remote ON/OFF Logic



Figure 4: Turn-on transient at zero load current) (20ms/div).
Top Trace: Vout; 5V/div; Bottom Trace: ON/OFF input: 5V/div.



Figure 5: Turn-on transient at full rated load current (20ms/div). Top Trace: Vout:5V/div; Bottom Trace: ON/OFF input:5V/div.

For Input Voltage Start up



Figure 6: Turn-on transient at zero load current (100 ms/div).
Top Trace: Vout; 5V/div; Bottom Trace: input voltage: 30V/div.



Figure 7: Turn-on transient at full rated load current (100 ms/div). Top Trace: Vout; 5V/div; Bottom Trace: input voltage: 30V/div.

ELECTRICAL CHARACTERISTICS CURVES

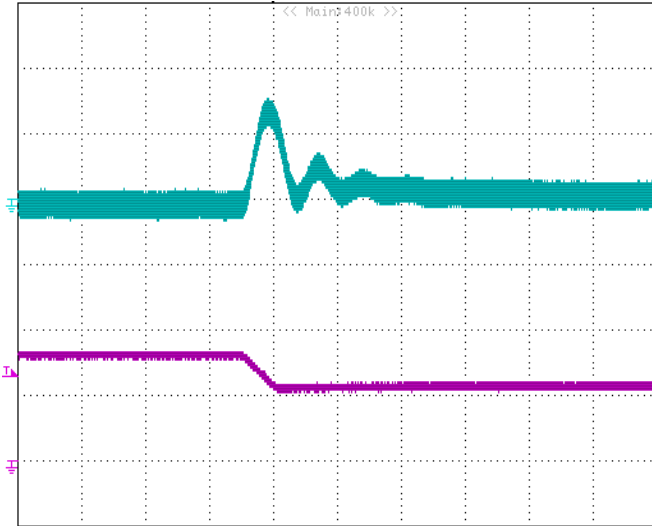

Figure 8: Output voltage response to step-change in load current (75%-50% of I_o , max; $di/dt = 0.1A/\mu s$, $V_{in}=48V$). Load cap: $300\mu F$, electrolytic capacitor ; $10\mu F$, tantalum capacitor and $1\mu F$ ceramic capacitor. Top Trace: V_{out} (200mV/div, 200us/div); Bottom Trace: I_o (20A/div, 200us/div). Scope measurement should be made using a BNC cable (length shorter than 20 inches). Position the load between 51 mm to 76 mm (2 inches to 3 inches) from the module..

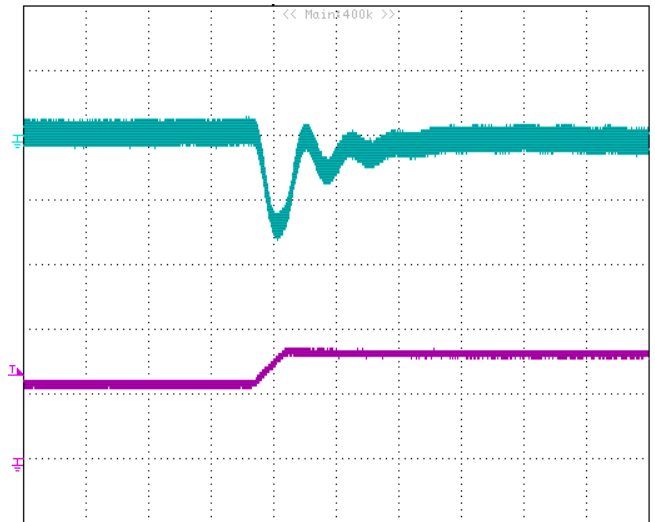

Figure 9: Output voltage response to step-change in load current (50%-75% of I_o , max; $di/dt = 0.1A/\mu s$, $V_{in}=48V$). Load cap: $300\mu F$, electrolytic capacitor ; $10\mu F$, tantalum capacitor and $1\mu F$ ceramic capacitor. Top Trace: V_{out} (200mV/div, 200us/div); Bottom Trace: I_o (20A/div, 200us/div). Scope measurement should be made using a BNC cable (length shorter than 20 inches). Position the load between 51 mm to 76 mm (2 inches to 3 inches) from the module..

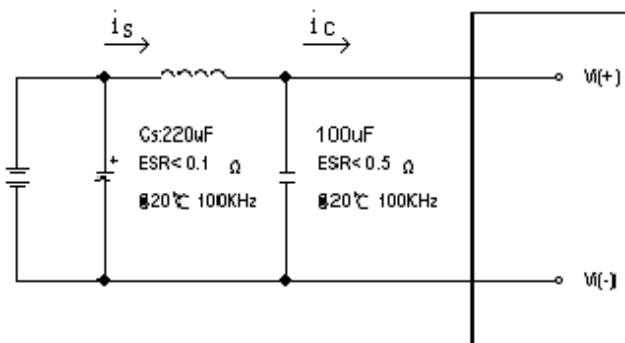

Figure 10: Test set-up diagram showing measurement points for Input Terminal Ripple Current and Input Reflected Ripple Current.

Note: Measured input reflected-ripple current with a simulated source Inductance (L_{TEST}) of $12\mu H$. Capacitor C_s offset possible battery impedance. Measure current as shown above.

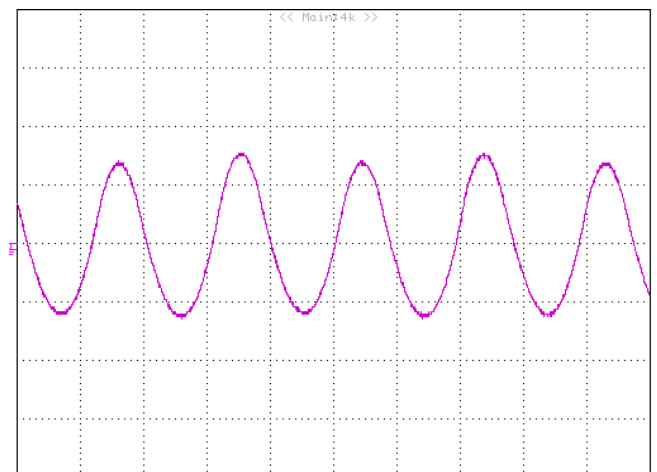

Figure 11: Input Terminal Ripple Current, i_c , at full rated output current and nominal input voltage with $12\mu H$ source impedance and $100\mu F$ electrolytic capacitor (1A/div, $2\mu s$ /div).

ELECTRICAL CHARACTERISTICS CURVES



Figure 12: Input reflected ripple current, i_s , through a $12\mu\text{H}$ source inductor at nominal input voltage and rated load current ($20\text{mA}/\text{div}$, $2\mu\text{s}/\text{div}$).



Figure 13: Output voltage noise and ripple measurement test setup.

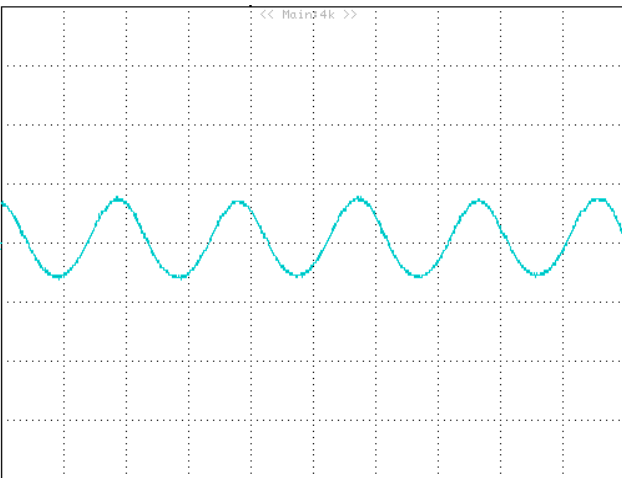

Figure 14: Output voltage ripple at nominal input voltage and rated load current ($I_o=42\text{A}$) ($50\text{mV}/\text{div}$, $2\mu\text{s}/\text{div}$)
Load capacitance: $300\mu\text{F}$ (Electrolytic) + $10\mu\text{F}$ (Tantalum) + $1\mu\text{F}$ (Ceramic) and min Co. Bandwidth: 20 MHz.

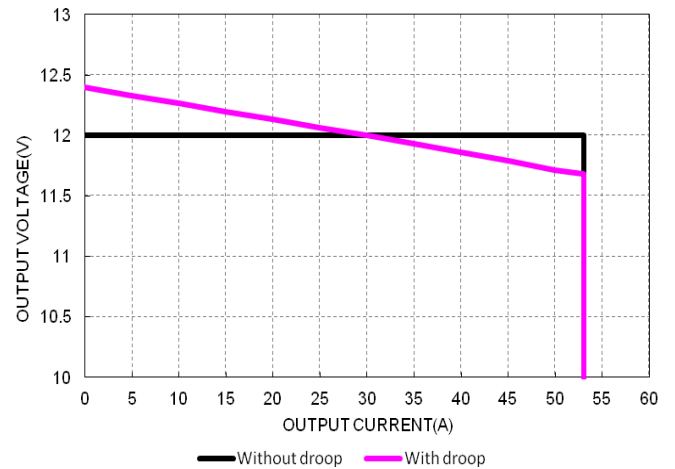

Figure 15: Output voltage vs. load current showing typical current limit curves and converter shutdown points.

Input Source Impedance

The impedance of the input source connecting to the DC/DC power modules will interact with the modules and affect the stability. A low ac-impedance input source is recommended. If the source inductance is more than a few μH , we advise adding a $100\mu\text{F}$ electrolytic capacitor (ESR $< 0.2 \Omega$ at 100 kHz) mounted close to the input of the module to improve the stability.

Layout and EMC Considerations

Delta's DC/DC power modules are designed to operate in a wide variety of systems and applications. For design assistance with EMC compliance and related PWB layout issues, please contact Delta's technical support team. An external input filter module is available for easier EMC compliance design. Below is the reference design for an input filter and tested result which can meet class B in CISPR 22.

Schematic:



Test result:



Safety Considerations

The power module must be installed in compliance with the spacing and separation requirements of the end-user's safety agency standard, i.e., UL60950-1, CSA C22.2 NO. 60950-1 2nd, IEC 60950-1 2nd : 2005, EN 60950-1 2nd: 2006+A11+A1: 2010, if the system in which the power module is to be used must meet safety agency requirements.

When the input source is SELV, the power module meets SELV (safety extra-low voltage) requirements. If the input source is a hazardous voltage which is greater than 60 Vdc and less than or equal to 75 Vdc, for the module's output to meet SELV requirements, all of the following must be met:

- The input source must be insulated from the ac mains by reinforced or double insulation.
- The input terminals of the module are not operator accessible.
- One Vout pin is grounded.
- A SELV reliability test is conducted on the system where the module is used, in combination with the module, to ensure hazardous voltage does not appear at the module's output.

When installed into a Class II equipment (without grounding), spacing consideration should be given to the end-use installation, as the spacing between the module and mounting surface have not been evaluated.

The power module has extra-low voltage (ELV) outputs when all inputs are ELV.

This power module is not internally fused. To achieve optimum safety and system protection, an input line fuse is highly recommended. The safety agencies require a normal-blow fuse with 50A maximum rating to be installed in the ungrounded lead. A lower rated fuse can be used based on the maximum inrush transient energy and maximum input current.

Soldering and Cleaning Considerations

Post solder cleaning is usually the final board assembly process before the board or system undergoes electrical testing. Inadequate cleaning and/or drying may lower the reliability of a power module and severely affect the finished circuit board assembly test. Adequate cleaning and/or drying is especially important for un-encapsulated and/or open frame type power modules. For assistance on appropriate soldering and cleaning procedures, please contact Delta's technical support team.

Over-Power Protection

The modules include an internal output over-power protection circuit, which will endure power limiting for an unlimited duration during output overload. If the output current exceeds the OCP set points, the modules will automatically shut down (hiccup mode).

The modules will try to restart after shutdown. If the overload condition still exists, the modules will shut down again. This restart trial will continue until the overload condition is corrected.

The OCP function could be changed via PMBUS. The command related to OCP function are IOUT_OC_WARN_LIMIT, IOUT_OC_FAULT_LIMIT and IOUT_OC_FAULT_RESPONSE.

Over-Temperature Protection

The over-temperature protection consists of circuitry that provides protection from thermal damage. If the temperature exceeds the over-temperature threshold, the modules will shut down, and enter the auto-restart mode.

For auto-restart mode, the module will monitor the module temperature after shutdown. Once the temperature of module is decreased by an OTP hysteresis, the module will restart.

The OTP function could be changed via PMBUS. The command related to OTP function are OT_WARN_LIMIT, OT_FAULT_LIMIT and OT_FAULT_RESPONSE.

Input Under Voltage Lockout

When Vin exceeds Vin turn on threshold, the module output is enabled, when Vin falls below Vin turn off threshold, the module output is disabled. Vin turn on threshold and Vin turn off threshold can be reconfigured via the PMBus interface.

The Vin UVP function could be changed via PMBUS. The command related to Vin UVP function are VIN_ON and VIN_OFF.

Output Overvoltage Protection

The module can detect and respond to output overvoltage conditions. If the overvoltage condition causes the output voltage to rise above the limit in the Specifications Table, the module will shut down.

The modules will try to restart after shutdown. If fault condition still exists, the modules will shut down again. This restart trial will continue until the fault condition is corrected.

The Vo OVP function could be changed via PMBUS. The command related to Vo OVP function are VOUT_OV_WARN_LIMIT, VOUT_OV_FAULT_LIMIT and VOUT_OV_FAULT_RESPONSE.

Input Over Voltage Lockout

The module can detect and respond to input overvoltage conditions. If the input voltage rises above the limit in the Specifications Table, the module will shut down.

The module is factory default configured for auto-restart operation. The auto-restart feature continually monitors the input voltage and will restart the module when the level falls 6V below the Input OVP level.

The Vin OVP function could be changed via PMBUS. The command related to Vin OVP function are VIN_OV_FAULT_LIMIT and VIN_OV_FAULT_RESPONSE.

Remote ON/OFF (ENABLE)

The remote ON/OFF (ENABLE) feature on the module is negative logic. The low logic turns the modules on. And the high logic, or floating, turns the modules off.

Remote ON/OFF (ENABLE) can be controlled by an external switch between the on/off terminal and the Vin(-) terminal. The switch can be an open collector or open drain.

For the negative logic, if the remote ON/OFF (ENABLE) feature is not used, please maintain the ENABLE pin to Vin(-).



Figure 16: Remote ON/OFF (ENABLE) implementation

Secondary Remote On/Off

Reference to the Vo(-) terminal, there is a C2 pin. The default configuration is set to PGOOD function. And such pin can be reconfigured as secondary remote on/off pin by the PMBus interface including either negative or positive logic. Negative logic turns the module on during a logic low and off during a logic high. Positive logic turns the modules on during a logic high and off during a logic low. The secondary remote on/off can be controlled by an external switch between the on/off terminal and the Vo(-) terminal. The switch can be an open collector or open drain.

MFR_C1_C2_ARA_CONFIG, MFR_C2_LOGIC, MFR_PGOOD_POLARITY are used to config C2 pin function.

Remote Sense

Remote sense minimizes the effects of distribution losses by regulating the voltage at the remote-sense connections (See Figure 17). The SENSE(-) pin should be always connected to VO(-) pin. The voltage between the remote-sense pins and the output terminals must not exceed the output voltage sense range given in the Feature Specifications

$$[VO(+)-VO(-)]-SENSE(+)\leq 0.5V$$

The output voltage can also be increased by the trim, the maximum increase for the output voltage is the sum of both. The amount of power delivered by the module is defined as the voltage at the output terminals multiplied by the output current. When using remote sense and trim, the output voltage of the module can be increased, which at the same output current, would increase the power output of the module. Care should be taken to ensure that the maximum output power of the module remains at or below the maximum rated power (Maximum rated power = Vo,set x Io,max)



Figure 17: Circuit Configuration for remote sense.

Configurable Control Pins

The module contains one configurable control pins C2, referenced to the module secondary SIG_GND. See Mechanical Views for pin locations. The following table list the default factory configurations for the functions assigned to the pin.

| Pin Designation/Function | Configuration |
|--------------------------|---------------------|
| C2 | |
| Power Good | Factory Default |
| On/Off | Optional Vias PMBUS |

Note1: Power Good is a Full-drive output, pull up to 3.3V internally,

Note2: On/Off is an Open-drian input

Output Voltage Adjustment (TRIM) ^{note1}

To increase or decrease the output voltage set point, connect an external resistor between the TRIM pin and either the Vo(+) or Vo(-). The TRIM pin should be left open if this feature is not used.

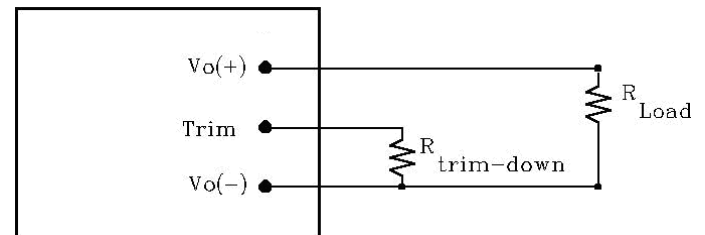

Figure 18: Circuit configuration for trim-down (decrease output voltage)

If the external resistor is connected between the TRIM and Vo (-) pins, the output voltage set point decreases (Fig. 18). The external resistor value required to obtain a percentage of output voltage change Δ% is defined as:

$$R_{trim_down} = \left[\frac{511}{\Delta} - 10.2 \right] (K\Omega)$$

Ex. When Trim-down -10% (12V×0.9=10.8V)

$$R_{trim_down} = \left[\frac{511}{10} - 10.2 \right] (K\Omega) = 40.9(K\Omega)$$



Figure 19: Circuit configuration for trim-up (increase output voltage)

If the external resistor is connected between the TRIM and Vo (+) the output voltage set point increases (Fig.19) The external resistor value required to obtain a percentage output voltage change $\Delta\%$ is defined as:

$$R_{trim_up} = \frac{5.11V_o(100 + \Delta)}{1.225\Delta} - \frac{511}{\Delta} - 10.2(K\Omega)$$

Ex. When Trim-up +10% (12V \times 1.1=13.2V)

$$R_{trim_up} = \frac{5.11 \times 12 \times (100 + 10)}{1.225 \times 10} - \frac{511}{10} - 10.2 = 489.3(K\Omega)$$

Care should be taken to ensure that the maximum output power of the module remains at or below the maximum rated power.

Note1: see the last page.

Power Good, PG*

The module provides a Power Good (PG) signal which is provided by the IC inside module, voltage level 3.3V, to indicate that the output voltage is within the normal output voltage range of the power module. The PG signal will be de-asserted to a low state if any condition such as overtemperature, overcurrent or loss of regulation occurs that would result in the output voltage going below the normal voltage range value.

The Vout PG function could be changed via PMBUS. The command related to POWER_GOOD_ON and POWER_GOOD_OFF.

Parallel and Droop Current Sharing

The modules are capable of operating in parallel, and realizing current sharing by droop current sharing method. There is about 500mV output voltage droop from 0A to full output Load, and there is no current sharing pin. By connecting the Vin pin and the Vo

pin of the parallel module together, the current sharing can be realized automatically.

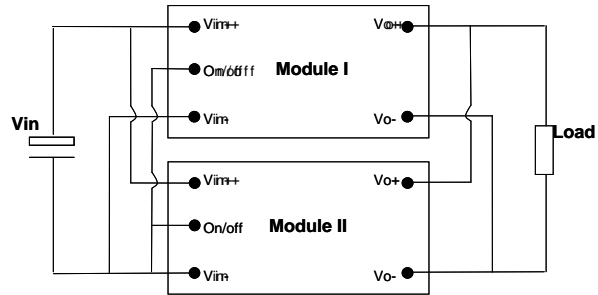

Figure 20: Parallel and droop current sharing configuration for no redundancy requirement system

If system has no redundancy requirement, the module can be parallel directly for higher power without adding external oring-fet; whereas, If the redundancy function is required, the external oring-fet should be added.

For a normal parallel operation the following precautions must be observed:

1. The current sharing accuracy equation is:

$$X\% = |I_o - (I_{total} / N)| / I_{rated}$$

Where, I_o is the output current of per module;

I_{total} is the total load current;

N is parallel module numbers;

I_{rated} is the rated full load current of per module.

2. To ensure a better steady current sharing accuracy, below design guideline should be followed:

a) The inputs of the converters must be connected to the same voltage source; and the PCB trace resistance from Input voltage source to V_{in+} and V_{in-} of each converter should be equalized as much as possible.

b) The PCB trace resistance from each converter's output to the load should be equalized as much as possible.

c) For accurate current sharing accuracy test, the module should be soldered in order to avoid the unbalance of the touch resistance between the modules to the test board.

3. To ensure the parallel module can start up monotonically without triggering the OCP circuit, below design guideline should be followed:

a) Before all the parallel module finished start up, the total load current should be lower than the rated current of 1 module.

b) The ON/OFF pin of the converters should be connected together to keep the parallel modules start up at the same time.

c) The under voltage lockout point will slightly vary from unit to unit. The dv/dt of the rising edge of the input source voltage must be greater than 1V/ms to ensure that the parallel module start up at the same time.

THERMAL CONSIDERATIONS

Thermal management is an important part of the system design. To ensure proper, reliable operation, sufficient cooling of the power module is needed over the entire temperature range of the module. Convection cooling is usually the dominant mode of heat transfer.

Hence, the choice of equipment to characterize the thermal performance of the power module is a wind tunnel.

Thermal Testing Setup

Delta's DC/DC power modules are characterized in heated vertical wind tunnels that simulate the thermal environments encountered in most electronics equipment. This type of equipment commonly uses vertically mounted circuit cards in cabinet racks in which the power modules are mounted.

The following figure shows the wind tunnel characterization setup. The power module is mounted on a 185mmX185mm,70µm (2Oz),6 layers test PWB and is vertically positioned within the wind tunnel. The space between the neighboring PWB and the top of the power module is constantly kept at 6.35mm (0.25").

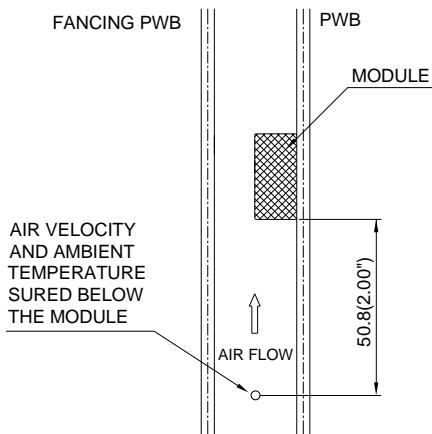

Note: Wind Tunnel Test Setup Figure Dimensions are in millimeters and (Inches)

Figure 21: Wind tunnel test setup

Thermal Derating

Heat can be removed by increasing airflow over the module. To enhance system reliability, the power module should always be operated below the maximum operating temperature. If the temperature exceeds the maximum module temperature, reliability of the unit may be affected.

THERMAL CURVES (WITH HEAT SPREADER)



Figure 22: * Hot spot's temperature measured point, the allowed maximum hot spot's temperature is defined at 102 °C



Figure 23: Output current vs. ambient temperature and air velocity @Vin=48V(Transverse Orientation, airflow from Vin+ to Vin-, with heat spreader)

DIGITAL FEATURE DESCRIPTIONS

The module has a digital PMBus interface to allow the module to be monitored, controlled and configured by the system. The module supports 4 PMBus signal lines, Data, Clock, SMBALERT (optional), Control (C2 pin, optional), and 2 Address line Addr0 and Addr1. More detail PMBus information can be found in the PMB Power Management Protocol Specification, Part I and part II, revision 1.2; which is shown in <http://pmbus.org>. Both 100kHz and 400kHz bus speeds are supported by the module. Connection for the PMBus interface should be following the High Power DC specifications given in section 3.1.3 in the SMBus specification V2.0 or the Low Power DC specifications in section 3.1.2. The complete SMBus specification is shown in <http://smbus.org>.

The module supports the Packet Error Checking (PEC) protocol. It can check the PEC byte provided by the PMBus master, and include a PEC byte in all message responses to the master. And the module also can communicate with the master that does not implement the PEC mechanism.

SMBALERT protocol is also supported by the module. SMBALERT line is also a wired-AND signal; by which the module can alert the PMBUS master via pulling the SMBALERT pin to an active low. There are only one way that the master and the module response to the alert of SMBALERT line.

This way is for the module used in a system that does not support Alert Response Address (ARA). The module is to retain its resistor programmed address, when it is in an ALERT active condition. The master will communicate with the slave module using the programmed address, and using the various READ_STATUS commands to find who cause for the SMBALERT. The CLEAR_FAULTS command will clear the SMBALERT.

The module contains a data flash used to store configuration settings, which will not be programmed into the device data flash automatically. The STORE_DEFAULT_ALL command must be used to commit the current settings are transfer from RAM to data flash as device defaults.

PMBUS Addressing

The Module has flexible PMBUS addressing capability. When connect different resistor from Addr0 and Addr1 pin to GND pin, 64 possible addresses can be acquired. The address is in the form of octal digits; Each pin offer one octal digit, and then combine together to form the decimal address as shown in below.

$$\text{Address} = 8 * \text{ADDR1} + \text{ADDR0}$$



Corresponded to each octal digit, the requested resistor values are shown in below, and +/-1% resistors accuracy can be accepted. If there is any resistances exceeding the requested range, address 127 will be return. 0-12 and 40, 44, 45, and 55 in decimal address can't be used, since they are reserved according to the SMBus specifications, and which will also return address 127.

| Octal digit | Resistor(Kohm) |
|-------------|----------------|
| 0 | 10 |
| 1 | 15.4 |
| 2 | 23.7 |
| 3 | 36.5 |
| 4 | 54.9 |
| 5 | 84.5 |
| 6 | 130 |
| 7 | 200 |

PMBus Data Format

The module receives and report date in LINEAR format. The Exponent of the data words is fixed at a reasonable value for the command; altering the exponent is not supported. DIRECT format is not supported by the module.

For commands that set or report any voltage thresholds related to the output voltage, the module supports the linear data format consisting of a two byte value with a 16-bit, unsigned mantissa, and a fixed exponent of -12. The format of the two data bytes is shown below:



The equation can be written as:

$$V_{out} = \text{Mantissa} \times 2^{(-12)}$$

For example, considering set V_{out} to 12V by $V_{OUT_COMMAND}$, the read/write data can be calculated refer to below process:

$$\text{Mantissa} = V_{out} / 2^{(-12)} = 12 / 2^{(-12)} = 49152;$$

Converter the calculated Mantissa to hexadecimal 0xC000.

For commands that set or report all other thresholds, including input voltages, output current, temperature, time and frequency, the supported linear data format is a two byte value with: an 11 bit, two's complement mantissa, and a 5 bit, two's complement exponent (scaling factor). The format of the two data bytes is shown as in below.

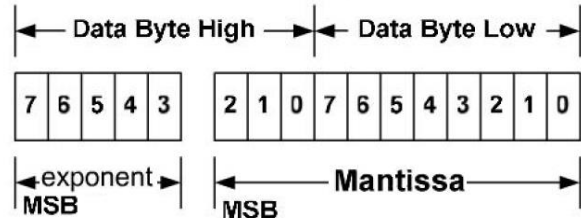

The equation can be written as:

$$\text{Value} = \text{Mantissa} \times 2^{(\text{exponent})}$$

For example, considering set the turn on threshold of input under voltage lockout to 34V by V_{IN_ON} command; the read/write data can be calculated refer to below process:

Get the exponent of V_{in} , -3; whose binary is 11101
 $\text{Mantissa} = V_{in} / 2^{(-3)} = 34 / 2^{(-3)} = 272;$

Converter the calculated Mantissa to hexadecimal 110, then converter to binary 00100010000; Combine the exponent and the mantissa, 11101 and 00100010000; Converter binary 1110100100010000 to hexadecimal E910.

SUPPORTED PMBUS COMMANDS

The main PMBus commands described in the PMBus 1.2 specification are supported by the module. Partial PMBus commands are fully supported; Partial PMBus commands have difference with the definition in PMBus 1.2 specification. All the supported PMBus commands are detail summarized in below table

| Command | Command Code | Command description | Transfer type | Compatible with standard PMBUS or not? | Data Format | Default value | Range limit | Data units | Exponent | Note |
|---------------------|--------------|--|---------------|--|------------------|---------------|--------------|------------|----------|--|
| OPERATION | 0x01 | Turn the module on or off by PMBUS command | R/W byte | Refer to below description; | Bit field | 0x80 | / | / | / | / |
| ON_OFF_CONFIG | 0x02 | Configures the combination of primary on/off pin and PMBUS command | Read byte | Yes | Bit field | 0x1D | / | / | / | 0x1D (Neg Logic); 0x1F (Pos Logic); |
| CLEAR_FAULTS | 0x03 | Clear any fault bits that have been set | Send byte | Yes | / | / | / | / | / | / |
| STORE_DEFAULT_ALL | 0x11 | Stores operating parameters from RAM to data flash | Send byte | Yes | / | / | / | / | / | This command is effective to the parameter of all command in this table. |
| RESTORE_DEFAULT_ALL | 0x12 | Restores operating parameters from data flash to RAM | Send byte | Yes | / | / | / | / | / | This command can't be issued when the power unit is running. |
| VOUT_MODE | 0x20 | Read Vo data format | Read byte | Yes | mode+exp | 0x14 | / | / | / | / |
| VOUT_COMMAND | 0x21 | Set the output voltage normal value | R/W word | Yes | Vout Linear | 12 | 6 ~13.2 | Volts | -12 | / |
| VOUT_MARGIN_HIGH | 0x25 | Set the output voltage margin high value | R/W word | Yes | Vout Linear | 12.6 | <13.0 | Volts | -12 | / |
| VOUT_MARGIN_LOW | 0x26 | Set the output voltage margin low value | R/W word | Yes | Vout Linear | 11.4 | >10.2 | Volts | -12 | / |
| FREQUENCY_SWITCH | 0x33 | Set the switching frequency | R/W word | Yes | Frequency linear | 130 | 120 ~ 180 | KHz | -2 | Write command need module off condition |

| Command | Command Code | Command description | Transfer type | Compatible with standard PMBUS or not? | Data Format | Default value | Range limit | Data units | Exponent | Note |
|------------------------|--------------|---|---------------|--|-------------|---------------|-------------|------------|----------|---|
| VIN_ON | 0x35 | Set the turn on voltage threshold of Vin under voltage lockout | R/W word | Yes | Vin Linear | 35 | 33~36 | V | -3 | VIN_ON should be higher than VIN_OFF |
| VIN_OFF | 0x36 | Set the turn off voltage threshold of Vin under voltage lockout | R/W word | Yes | Vin Linear | 33 | 31~34 | V | -3 | VIN_ON should be higher than VIN_OFF |
| VOUT_OV_FAULT_LIMIT | 0x40 | Set the output overvoltage fault threshold. | R/W word | Yes | Vout Linear | 15 | 11~16 | V | -12 | Must be higher than the value of VOUT_COMMAND and VOUT_OV_WARN_LIMIT; |
| VOUT_OV_FAULT_RESPONSE | 0x41 | Instructs what action to take in response to an output overvoltage fault. | Read byte | Refer to below description; | Bit field | 0xB8 | / | N/A | / | Default Hiccup mode |
| VOUT_OV_WARN_LIMIT | 0x42 | Set a threshold causing an output voltage high warning. | R/W word | Yes | Vout Linear | 14 | 11~16 | V | -12 | Must be the same or less than VOUT_OV_FAULT_LIMIT value |
| IOUT_OC_FAULT_LIMIT | 0x46 | Set the output overcurrent fault threshold. | R/W word | Yes | Iout Linear | 53 | 33~55 | A | -4 | Must be greater than IOUT_OC_WARN_LIMIT value |
| IOUT_OC_FAULT_RESPONSE | 0x47 | Instructs what action to take in response to an output overcurrent fault. | Read byte | Refer to below description; | Bit field | 0xF8 | / | N/A | / | Default Hiccup mode |
| IOUT_OC_WARN_LIMIT | 0x4A | Set a threshold causing an output current high warning. | R/W word | Yes | Iout Linear | 47 | 33~55 | A | -4 | Must be less than IOUT_OC_FAULT_LIMIT value |
| OT_FAULT_LIMIT | 0x4F | Set the over temperature fault threshold. | R/W word | Yes | TEMP Linear | 125 | 25~140 | Deg. C | -2 | Must be greater than OT_WARN_LIMIT value |
| OT_FAULT_RESPONSE | 0x50 | Instructs what action to take in response to an over temperature fault. | Read byte | Refer to below description; | Bit field | 0xB8 | / | N/A | / | Default Hiccup mode |

| Command | Command Code | Command description | Transfer type | Compatible with standard PMBUS or not? | Data Format | Default value | Range limit | Data units | Exponent | Note |
|-----------------------|--------------|---|---------------|--|-------------|---------------|-------------|------------|----------|---|
| OT_WARN_LIMIT | 0x51 | Set a threshold causing a temperature high warning. | R/W word | Yes | TEMP Linear | 100 | 25~140 | Deg.C | -2 | Must be less than OT_FAULT_LIMIT value |
| VIN_OV_FAULT_LIMIT | 0x55 | Set the input overvoltage fault threshold. | R/W word | Yes | Vin Linear | 100 | 48~100 | V | -3 | / |
| VIN_OV_FAULT_RESPONSE | 0x56 | Instructs what action to take in response to an input overvoltage fault. | Read byte | Refer to below description; | Bit field | 0XF8 | / | N/A | / | Default Hiccup mode |
| POWER_GOOD_ON | 0x5E | Sets the output voltage at which the bit 3 of STATUS_WORD high byte should be asserted. | R/W word | Yes | Vout Linear | 11 | 8 ~13.2 | V | -12 | Must be greater than POWER_GOOD_OFF value |
| POWER_GOOD_OFF | 0x5F | Sets the output voltage at which the bit 3 of STATUS_WORD high byte should be negated. | R/W word | Yes | Vout Linear | 9 | 8 ~13.2 | V | -12 | Must be less than POWER_GOOD_ON value |
| TON_DELAY | 0x60 | Sets the time from a start condition is received until the output voltage starts to rise | R/W word | Yes | Time Linear | 20 | 20~500 | ms | -1 | / |
| TON_RISE | 0x61 | Sets the time from the output starts to rise until the voltage has entered the regulation band. | R/W word | Yes | Time Linear | 30 | 15~500 | ms | -1 | / |
| STATUS_WORD | 0x79 | Returns the information with a summary of the module's fault/warning | Read word | Refer to below description; | Bit field | / | / | / | / | / |
| STATUS_VOLT | 0x7A | Returns the information of the module's output voltage related fault/warning | Read byte | Refer to below description; | Bit field | / | / | / | / | / |
| STATUS_CURRENT | 0x7B | Returns the information of the module's output current related fault/warning | Read byte | Refer to below description; | Bit field | / | / | / | / | / |

| Command | Command Code | Command description | Transfer type | Compatible with standard PMBUS or not? | Data Format | Default value | Range limit | Data units | Exponent | Note |
|----------------------|--------------|--|---------------|--|---------------------------|---------------|-------------|------------|----------|---|
| STATUS_INPUT | 0x7C | Returns the information of the module's input over voltage and under voltage fault | Read byte | Refer to below description; | Bit field | / | / | / | / | / |
| STATUS_TEMPERATURE | 0x7D | Returns the information of the module's temperature related fault/warning | Read byte | Refer to below description; | Bit field | / | / | / | / | / |
| STATUS_CMML | 0x7E | Returns the information of the module's communication related faults. | Read byte | Refer to below description; | Bit field | / | / | / | / | / |
| READ_VIN | 0x88 | Returns the input voltage of the module | Read word | Yes | Vin Linear | / | / | V | -3 | / |
| READ_VOULT | 0x8B | Returns the output voltage of the module | Read word | Yes | Vout Linear | / | / | V | -12 | / |
| READ_IOUT | 0x8C | Returns the output current of the module | Read word | Yes | Iout Linear | / | / | A | -4 | / |
| READ_TEMPERATURE_1 | 0x8D | Returns the module's hot spot temperature of the module | Read word | Yes | TEMP Linear | / | / | Deg.C | -2 | / |
| PMBUS_REVISION | 0x98 | Reads the revision of the PMBus | Read byte | Yes | Bit field | 0x42 | / | / | / | / |
| MFR_C1_C2_ARA_CONFIG | 0xE0 | Config C2 pin function | R/W byte | Refer to below description; | Bit field | 0x00 | / | / | / | / |
| MFR_C2_Configure | 0xE1 | Config C2 pin logic | R/W byte | Refer to below description; | Bit field | 0x00 | / | / | / | / |
| MFR_PGOOD_POLARITY | 0xE2 | Config Power Good logic | R/W byte | Refer to below description; | Bit field | 0x01 | / | / | / | Default Positive PGOOD logic |
| MFR_SERIAL | 0x9E | Reads the SN of module | Read block | / | Total 11 ASCII characters | 'xxxxxxxxxx' | / | / | / | The SN number of module use 11 ASCII characters |

OPERATION [0x01]

| Bit number | Purpose | Bit Value | Meaning | Default Settings, 0x80 |
|------------|---------------------------|-----------|---------------------------|------------------------|
| 7: | Enable/Disable the module | 1 | Output is enabled | 1 |
| | | 0 | Output is disabled | |
| 6: | Reserved | | | 0 |
| 5:4 | Margins | 00 | No margin | 00 |
| | | 01 | Margin low(Act on Fault) | |
| | | 10 | Margin high(Act on Fault) | |
| 3:0 | Reserved | | | 0000 |

VOUT_OV_FAULT_RESPONSE [0x41]

| Bit number | Purpose | Bit Value | Meaning | Default Settings, 0xB8 |
|------------|--------------------|-----------|---|------------------------|
| 7:6 | Response settings | 10 | Unit shuts down and responds according to the retry settings | 10 |
| 5:3 | Retry setting | 111 | Unit continuously restarts while fault is present until commanded off | 111 |
| | | 000 | Unit does not attempt to restart on fault | |
| 2:0 | Delay time setting | 000 | No delay supported | 000 |

IOUT_OC_FAULT_RESPONSE [0x47]

| Bit number | Purpose | Bit Value | Meaning | Default Settings, 0xF8 |
|------------|--------------------|-----------|---|------------------------|
| 7:6 | Response settings | 11 | Unit shuts down and responds according to the retry settings | 11, |
| 5:3 | Retry settings | 111 | Unit continuously restarts while fault is present until commanded off | 111 |
| | | 000 | Unit does not attempt to restart on fault | |
| 2:0 | Delay time setting | 000 | No delay supported | 000 |

OT_FAULT_RESPONSE [0x50]

| Bit number | Purpose | Bit Value | Meaning | Default Settings, 0xB8 |
|------------|--------------------|-----------|---|------------------------|
| 7:6 | Response settings | 10 | Unit shuts down and responds according to the retry settings | 10, |
| 5:3 | Retry settings | 111 | Unit continuously restarts while fault is present until commanded off | 111 |
| | | 000 | Unit does not attempt to restart on fault | |
| 2:0 | Delay time setting | 000 | No delay supported | 000 |

VIN_OV_FAULT_RESPONSE [0x56]

| Bit number | Purpose | Bit Value | Meaning | Default Settings, 0xF8 |
|------------|--------------------|-----------|---|------------------------|
| 7:6 | Response settings | 11 | Unit shuts down and responds according to the retry settings | 11 |
| 5:3 | Retry setting | 111 | Unit continuously restarts while fault is present until commanded off | 111 |
| | | 000 | Unit does not attempt to restart on fault | |
| 2:0 | Delay time setting | 000 | No delay supported | 000 |

STATUS_WORD [0x79]

High byte

| Bit number | Purpose | Bit Value | Meaning |
|------------|---|-----------|-------------|
| 7 | An output over voltage fault or warning | 1 | Occurred |
| | | 0 | No Occurred |
| 6 | An output over current fault or warning | 1 | Occurred |
| | | 0 | No Occurred |
| 5 | An input voltage fault, including over voltage and undervoltage | 1 | Occurred |
| | | 0 | No Occurred |
| 4 | Reserved | | |
| 3 | Power_Good | 1 | is negated |
| | | 0 | ok |
| 2:0 | Reserved | | |

Low byte

| Bit number | Purpose | Bit Value | Meaning |
|------------|---|-----------|-------------|
| 7 | Reserved | | |
| 6 | OFF (The unit is not providing power to the output, regardless of the reason) | 1 | Occurred |
| | | 0 | No Occurred |
| 5 | An output over voltage fault | 1 | Occurred |
| | | 0 | No Occurred |
| 4 | An output over current fault | 1 | Occurred |
| | | 0 | No Occurred |
| 3 | An input under voltage fault | 1 | Occurred |
| | | 0 | No Occurred |
| 2 | A temperature fault or warning | 1 | Occurred |
| | | 0 | No Occurred |
| 1 | CML (A communications, memory or logic fault) | 1 | Occurred; |
| | | 0 | No Occurred |
| 0 | Reserved | | |

STATUS_VOUT [0x7A]

| Bit number | Purpose | Bit Value | Meaning |
|------------|-----------------------------|-----------|-------------|
| 7 | Output over voltage fault | 1 | Occurred; |
| | | 0 | No Occurred |
| 6 | Output over voltage warning | 1 | Occurred; |
| | | 0 | No Occurred |
| 5:0 | Reserved | | |

STATUS_IOUT [0x7B]

| Bit number | Purpose | Bit Value | Meaning |
|------------|-----------------------------|-----------|-------------|
| 7 | Output over current fault | 1 | Occurred; |
| | | 0 | No Occurred |
| 6 | Reserved | | |
| 5 | Output over current warning | 1 | Occurred; |
| | | 0 | No Occurred |
| 4:0 | Reserved | | |

STATUS_INPUT [0x7C]

| Bit number | Purpose | Bit Value | Meaning |
|------------|---------------------------|-----------|-------------|
| 7 | Input over voltage fault | 1 | Occurred; |
| | | 0 | No Occurred |
| 6: 5 | Reserved | | |
| 4 | Input under voltage fault | 1 | Occurred; |
| | | 0 | No Occurred |
| 3:0 | Reserved | | |

STATUS_TEMPERATURE [0x7D]

| Bit number | Purpose | Bit Value | Meaning |
|------------|--------------------------|-----------|-------------|
| 7 | Over temperature fault | 1 | Occurred; |
| | | 0 | No Occurred |
| 6 | Over temperature warning | 1 | Occurred; |
| | | 0 | No Occurred |
| 5:0 | Reserved | | |

STATUS_CML [0x7E]

| Bit number | Purpose | Bit Value | Meaning |
|------------|--------------------------------------|-----------|-------------|
| 7 | Invalid/Unsupported Command Received | 1 | Occurred; |
| | | 0 | No Occurred |
| 6 | Invalid/Unsupported Data Received | 1 | Occurred; |
| | | 0 | No Occurred |
| 5 | Packet Error Check Failed | 1 | Occurred; |
| | | 0 | No Occurred |
| 4:0 | Reserved | | |

MFR_C1_C2_ARA_CONFIG [0xE0]

| Bit number | Purpose | Bit Value | Meaning |
|------------|-------------------|-----------|---|
| 7:5 | Reserved | 000 | Reserved |
| 4 | ARA | 0 | ARA not functional, module remains at resistor programmed address when SMBLAERT is asserted |
| 3:0 | PIN Configuration | 0000 | C2 pin: POWER_GOOD |
| | | 0010 | C2 pin: ON/OFF (Secondary) |

MFR_C2_Configure [0xE1]

| Bit number | Purpose | Bit Value | Meaning |
|------------|-----------------------------|-----------|--|
| 7:2 | Reserved | 000000 | Reserved |
| 1 | ON/OFF Configuration | 0 | Secondary side on/off pin state when mapped to C2 is ignored |
| | | 1 | AND – Primary and Secondary side on/off |
| 0 | Secondary Side ON/OFF Logic | 0 | Negative Logic (Low Enable: Input < 0.8V wrt Vout(-)) |
| | | 1 | Positive Logic (High Enable: Input > 2.0V wrt Vout(-)) |

MFR_PGOOD_POLARITY [0xE2]

| Bit number | Purpose | Bit Value | Meaning |
|------------|------------------|-----------|----------------------|
| 7:1 | Reserved | 0000000 | Reserved |
| 0 | Power Good Logic | 0 | Negative PGOOD logic |
| | | 1 | Positive PGOOD logic |

MECHANICAL DRAWING(WITH HEAT-SPREADER)

***For modules with through-hole pins and the optional heat spreader, they are intended for wave soldering assembly onto system boards, please do not subject such modules through reflow temperature profile.**

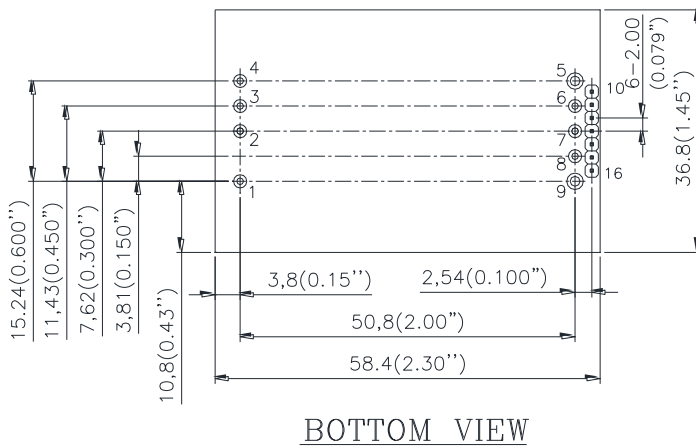

| PIN | NAME | OPTIONAL |
|-----|----------|----------|
| 1 | Vin(+) | |
| 2 | ON/OFF | |
| 3 | Case | YES |
| 4 | Vin(-) | |
| 5 | Vout(-) | |
| 6 | Sense(-) | YES |
| 7 | Trim | YES |
| 8 | Sense(+) | YES |
| 9 | Vout(+) | |
| 10 | C2 | YES |
| 11 | DGND | |
| 12 | PMBData | |
| 13 | SMBAlert | |
| 14 | PMBCLK | |
| 15 | Addr1 | |
| 16 | Addr0 | |

NOTES:
DIMENSIONS ARE IN MILLIMETERS AND (INCHES)
TOLERANCES: X.Xmm \pm 0.5mm(X.XX in. \pm 0.02 in.)
X.XXmm \pm 0.25mm(X.XXX in. \pm 0.010 in.)

Pin Specification:

Pins 1-4, 6-8
Pins 5,9
Pins 10-16

1.00mm (0.040") diameter (All pins are copper with matte Tin plating over Nickel under plating)
1.50mm (0.059") diameter (All pins are copper with matte Tin plating over Nickel under plating)
SQ 0.50mm(0.020") (All pins are copper with gold flash plating)

RECOMMENDED LAYOUT

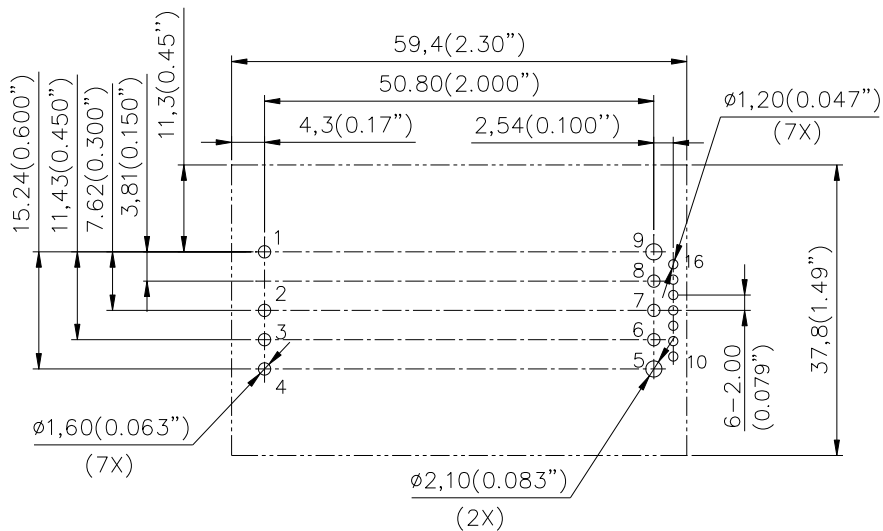

| PIN | NAME | OPTIONAL |
|-----|----------|----------|
| 1 | Vin(+) | |
| 2 | ON/OFF | |
| 3 | Case | YES |
| 4 | Vin(-) | |
| 5 | Vout(-) | |
| 6 | Sense(-) | YES |
| 7 | Trim | YES |
| 8 | Sense(+) | YES |
| 9 | Vout(+) | |
| 10 | C2 | YES |
| 11 | DGND | |
| 12 | PMBData | |
| 13 | SMBAlert | |
| 14 | PMBCLK | |
| 15 | Addr1 | |
| 16 | Addr0 | |



PART NUMBERING SYSTEM

| Q | 48 | S | C | 120 | 42 | N | R | D | H | | | | |
|-------------------|---------------|-------------------|-------------------|----------------|----------------|------------------------------|--|--|-------------|----------|-----------------|---------------|----------|
| Type of Product | Input Voltage | Number of Outputs | Product Series | Output Voltage | Output Current | ON/OFF Logic | Pin Length /Type | Pin assignment | Option Code | | | | |
| Q - Quarter Brick | 48 - 36~75V | S - Single | C - Series number | 120 - 12V | 42 - 42A | P - Positive N - Negative | R - 0.170" N - 0.145" K - 0.110" | D - Digital pins A - Analog pins I - IBC pins T - Trim pins | | Trim Pin | Current sharing | Heat spreader | Case pin |
| | | | | | | | | | H | Yes | No | Yes | No |
| | | | | | | | | | I | No | Droop | Yes | No |
| | | | | | | | | | J | No | No | Yes | No |
| | | | | | | | | | R | Yes | No | Yes | Yes |
| | | | | | | | | | S | No | Droop | Yes | Yes |
| | | | | | | | | | T | No | No | Yes | Yes |

Note for mechanical pins option:

1. D- Digital pins*: with digital pins & sense pins
2. A- Analog pins*: with sense pins, without digital pins
3. I- IBC pins*: without digital pins & sense pins
4. T- Trim pins: with digital pins, without sense pins

*There is no Power Good (PG) function, if customers need , please contact with Delta.

MODEL LIST

| MODEL NAME | INPUT | | OUTPUT | | EFF @ 100%LOAD |
|----------------|---------|-------|--------|-----|----------------|
| Q48SC12042NRDH | 36V~75V | 17.5A | 12V | 42A | 95.0% |
| Q48SC12042NRAH | 36V~75V | 17.5A | 12V | 42A | 95.0% |
| Q48SC12042NRDR | 36V~75V | 17.5A | 12V | 42A | 95.0% |
| Q48SC12042NRIJ | 36V~75V | 17.5A | 12V | 42A | 95.0% |

Note: If use VOUT_COMMAND of PMBUS to trim Vout set point, then the function of trim pin(6 pin) will be disabled immediately. And if need enable the function of trim pin(6pin) to trim Vout set point again, should turn off and turn on the input voltage of module to restart module.

CONTACT: www.deltaww.com/dcdc

Email: dcdc@deltaww.com

USA:

Telephone:
East Coast: 978-656-3993
West Coast: 510-668-5100
Fax: (978) 656 3964

Europe:

Phone: +31-20-655-0967
Fax: +31-20-655-0999

Asia & the rest of world:

Telephone: +886 3 4526107
ext 6220~6224
Fax: +886 3 4513485

WARRANTY

Delta offers a two (2) year limited warranty. Complete warranty information is listed on our web site or is available upon request from Delta.

Information furnished by Delta is believed to be accurate and reliable. However, no responsibility is assumed by Delta for its use, nor for any infringements of patents or other rights of third parties, which may result from its use. No license is granted by implication or otherwise under any patent or patent rights of Delta. Delta reserves the right to revise these specifications at any time, without notice.



Компания «ЭлектроПласт» предлагает заключение долгосрочных отношений при поставках импортных электронных компонентов на взаимовыгодных условиях!

Наши преимущества:

- Оперативные поставки широкого спектра электронных компонентов отечественного и импортного производства напрямую от производителей и с крупнейших мировых складов;
- Поставка более 17-ти миллионов наименований электронных компонентов;
- Поставка сложных, дефицитных, либо снятых с производства позиций;
- Оперативные сроки поставки под заказ (от 5 рабочих дней);
- Экспресс доставка в любую точку России;
- Техническая поддержка проекта, помощь в подборе аналогов, поставка прототипов;
- Система менеджмента качества сертифицирована по Международному стандарту ISO 9001;
- Лицензия ФСБ на осуществление работ с использованием сведений, составляющих государственную тайну;
- Поставка специализированных компонентов (Xilinx, Altera, Analog Devices, Intersil, Interpoint, Microsemi, Aeroflex, Peregrine, Syfer, Eurofarad, Texas Instrument, Miteq, Cobham, E2V, MA-COM, Hittite, Mini-Circuits, General Dynamics и др.);

Помимо этого, одним из направлений компании «ЭлектроПласт» является направление «Источники питания». Мы предлагаем Вам помощь Конструкторского отдела:

- Подбор оптимального решения, техническое обоснование при выборе компонента;
- Подбор аналогов;
- Консультации по применению компонента;
- Поставка образцов и прототипов;
- Техническая поддержка проекта;
- Защита от снятия компонента с производства.



Как с нами связаться

Телефон: 8 (812) 309 58 32 (многоканальный)

Факс: 8 (812) 320-02-42

Электронная почта: org@eplast1.ru

Адрес: 198099, г. Санкт-Петербург, ул. Калинина, дом 2, корпус 4, литера А.