

ZRB500
PRECISION 5V MICROPOWER VOLTAGE REFERENCE

Description

The ZRB500 uses a bandgap circuit design to achieve a precision micropower voltage reference of 5.0 volts. The device is available in small outline surface mount packages, ideal for applications where space saving is important, as well as packages for through hole requirements.

The ZRB500 design provides a stable voltage without an external capacitor and is stable with capacitive loads. The ZRB500 is recommended for operation between 50_A and 15mA and so is ideally suited to low power and battery powered applications.

Excellent performance is maintained to an absolute maximum of 25mA, however the rugged design and 20 volt processing allows the reference to withstand transient effects and currents up to 200mA. Superior switching capability allows the device to reach stable operating conditions in only a few microseconds.

Features

- ± 2% and 1% tolerance
- Operating current 50_A to 15mA
- Typical TC 15ppm/°C
- Transient response, stable in less than 10 μ s
- Industrial temperature range
- Small outline SOT23 style package
- Green molding compound (No Br, Sb)

Applications

- Battery powered and portable equipment
- Metering and measurement systems
- Instrumentation
- Test equipment
- Data acquisition systems
- Precision power supplies

Typical Application Circuit

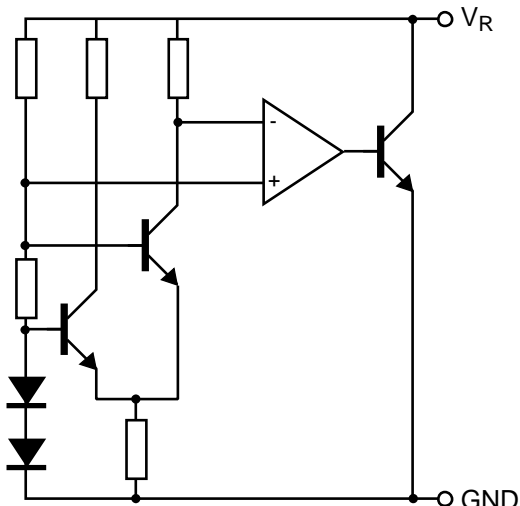

Pin Assignments

SOT23
package suffix - F

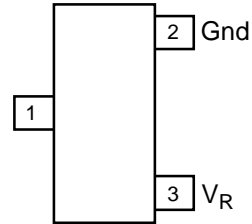

Pin 1 floating or connected to pin 2

E-Line, 2 pin
package suffix - Y

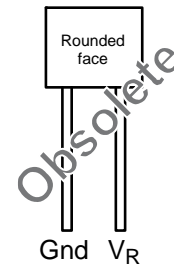

E-Line, 3 pin, rev
package suffix - R

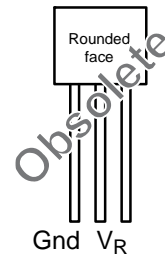

E-Line, 3 pin
package suffix - A

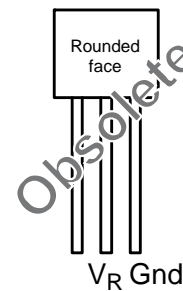

Absolute Maximum Ratings (Voltages to GND Unless Otherwise Stated)

Parameter	Rating	Unit
Reverse Current	25	mA
Forward Current	25	mA
Operating Temperature	-40 to 85	°C
Storage Temperature	-55 to 125	°C
Power Dissipation (T _{AMB} = 25°C) SOT23	330	mW

Electrical Characteristics (Test conditions: T_{amb} = 25°C, unless otherwise specified.)

Symbol	Parameter	Condition	Min.	Typ.	Max.	Tol. (%)	Unit
V _R	Reverse breakdown voltage	I _R = 150µA	4.95 4.90	5.0 5.0	5.05 5.10	1 2	V
I _{MIN}	Minimum operating current			30	50		µA
I _R	Recommended operating current		0.05		15		mA
T _C ^(*)	Average reverse breakdown voltage temperature coefficient	I _R (MIN) to I _R (MAX)		15	50		ppm/°C
R _S ^(†)	Slope resistance			0.33	1.5		Ω
Z _R	Reverse dynamic impedance	I _R = 1mA f = 100Hz I _{AC} = 0.1I _R		0.4	1		Ω
E _N	Wideband noise voltage	I _R = 150µA f = 10Hz to 10kHz		105			µV(rms)

Notes:

$$(*) T_C = \frac{(V_{R(MAX)} - V_{R(MIN)}) \times 1000000}{V_R \times (T_{(MAX)} - T_{(MIN)})}$$

Note: V_{R(MAX)} - V_{R(MIN)} is the maximum deviation in reference voltage measured over the full operating temperature range.

$$(†) R_S = \frac{V_R \text{ Change (I}_{R(MIN)} \text{ to I}_{R(MAX)})}{I_{R(MAX)} - I_{R(MIN)}}$$

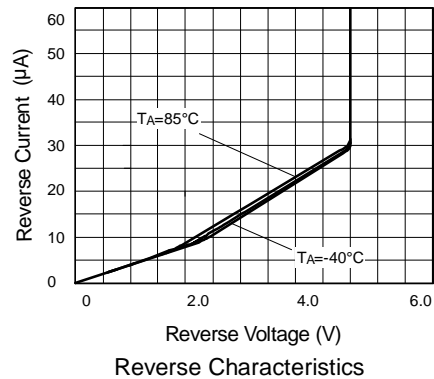

Typical Characteristics

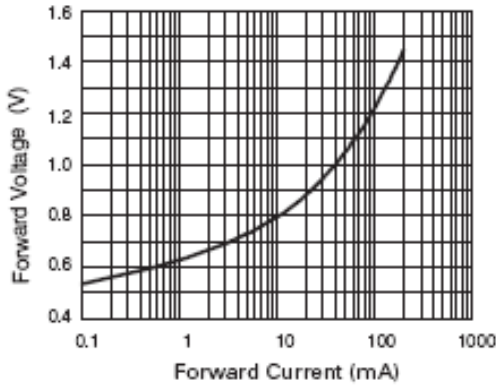

Forward Characteristics

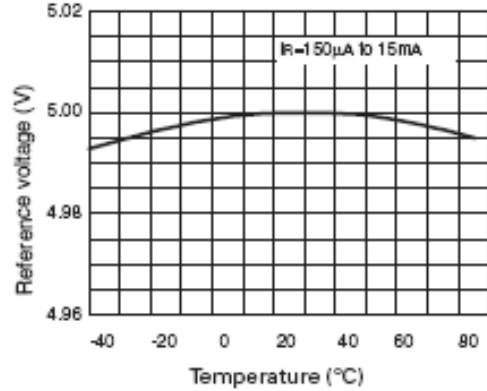

Temperature Drift

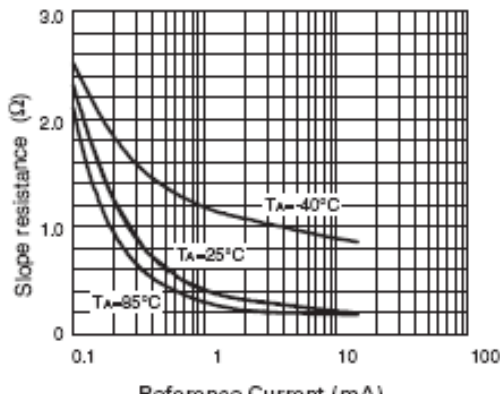

Slope Resistance v Current

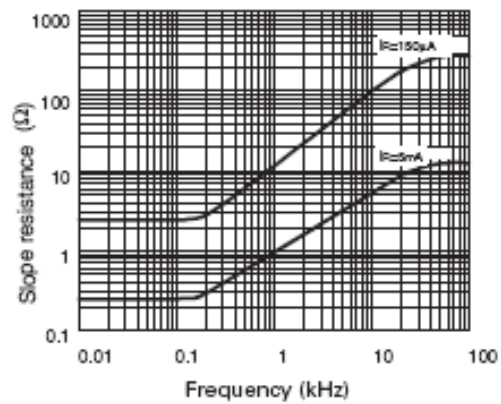

Slope Resistance v Frequency

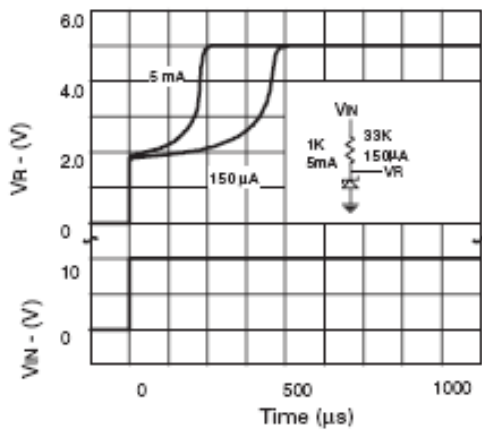

Transient Response (Single Pulse)

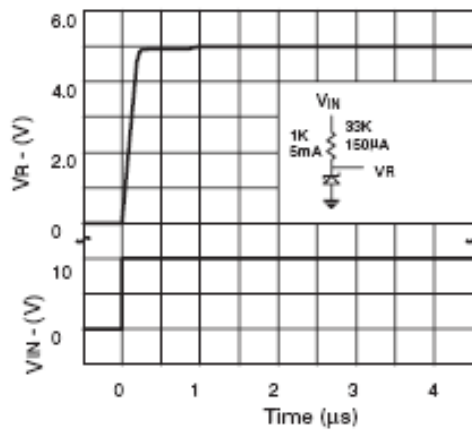

Transient Response (Repetitive Pulse)

Ordering Information*

Order Reference	Tol (%)	Device Mark	Status (*)	Reel Size (inches)	Quantity per reel	Tape Width (mm)
ZRB500F01TA	1	50I	Released	7	3000	8
ZRB500F02TA	2	50H	Released	7	3000	8
ZRB500F03TA	3	50G	Obsolete	7	3000	8

Notes: *All ZRB500A variants (E-Line 3-pin), ZRB500Y variants (E-Line 2-pin), ZRB500R variants (E-Line 3-pin reversed) and ZRB500N8 variants (SO-8) are obsolete no longer available for sale. The closest alternative is the SOT23.

Package Outline Dimensions

SOT23

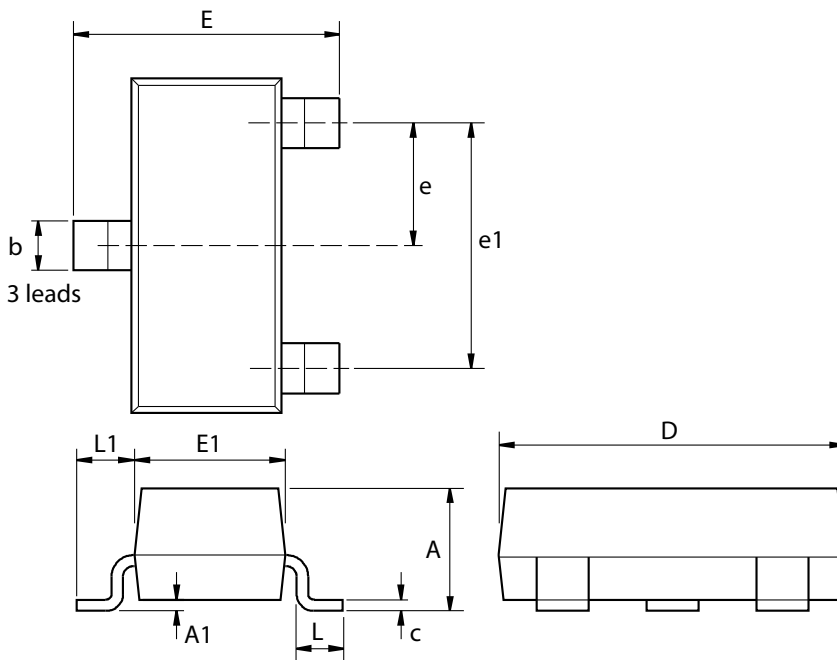

Dim.	Millimeters		Inches		Dim.	Millimeters		Inches	
	Min.	Max.	Min.	Max.		Min.	Max.	Min.	Max.
A	-	1.12	-	0.044	e1	1.90 NOM		0.075 NOM	
A1	0.01	0.10	0.0004	0.004	E	2.10	2.64	0.083	0.104
b	0.30	0.50	0.012	0.020	E1	1.20	1.40	0.047	0.055
c	0.085	0.20	0.003	0.008	L	0.25	0.60	0.0098	0.0236
D	2.80	3.04	0.110	0.120	L1	0.45	0.62	0.018	0.024
e	0.95 NOM		0.037 NOM		-	-	-	-	-

Note: Controlling dimensions are in millimeters. Approximate dimensions are provided in inches

Package Outline Dimensions

SO-8-EP

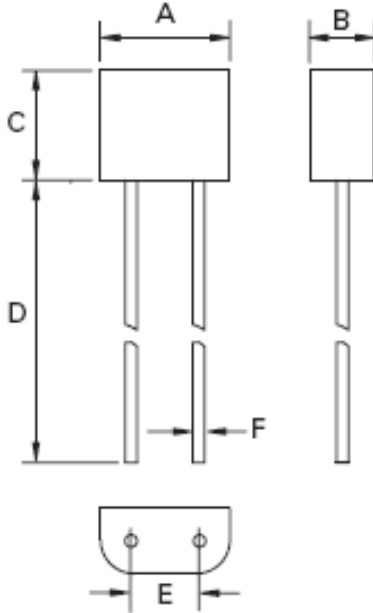

DIM	Millimeters		Inches	
	Min.	Max.	Min.	Max.
A	4.37	4.77	0.17	0.18
B	2.16	2.41	0.085	0.095
C	3.61	4.01	0.14	0.16
D	13.00	13.97	0.51	0.55
E	2.54 NOM		0.10 NOM	
F	0.37	0.495	0.015	0.019

Note: Controlling dimensions are in millimeters. Approximate dimensions are provided in inches

Package Outline Dimensions

E-Line, 3 pin rev.

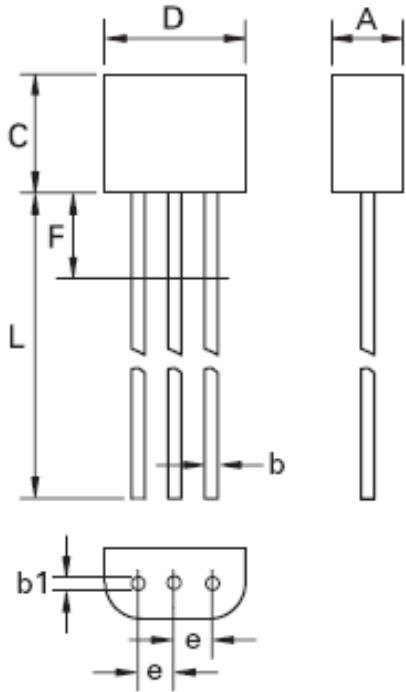

DIM	Millimeters		Inches	
	Min.	Max.	Min.	Max.
A	2.16	2.41	0.085	0.095
b	0.41	0.495	0.016	0.0195
b1	0.41	0.495	0.016	0.0195
D	4.37	4.77	0.172	0.188
E	3.61	4.01	0.142	0.158
e	1.27 NOM		0.050 NOM	
F	—	2.50	—	0.098
L	13.00	13.97	0.512	0.550

Note: Controlling dimensions are in millimeters. Approximate dimensions are provided in inches

Package Outline Dimensions

E-Line, 3 pin

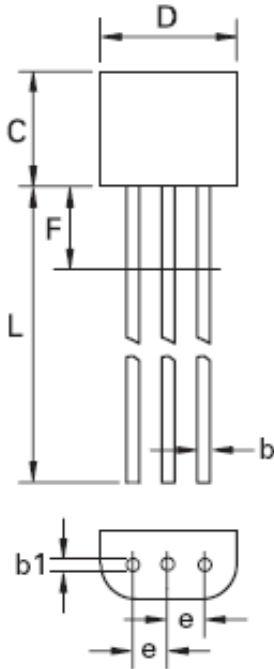

DIM	Millimeters		Inches	
	Min.	Max.	Min.	Max.
A	2.16	2.41	0.085	0.095
b	0.41	0.495	0.016	0.0195
b1	0.41	0.495	0.016	0.0195
D	4.37	4.77	0.172	0.188
E	3.61	4.01	0.142	0.158
e	1.27 NOM		0.050 NOM	
F	—	2.50	—	0.098
L	13.00	13.97	0.512	0.550

Note: Controlling dimensions are in millimeters. Approximate dimensions are provided in inches

Package Outline Dimensions

S08

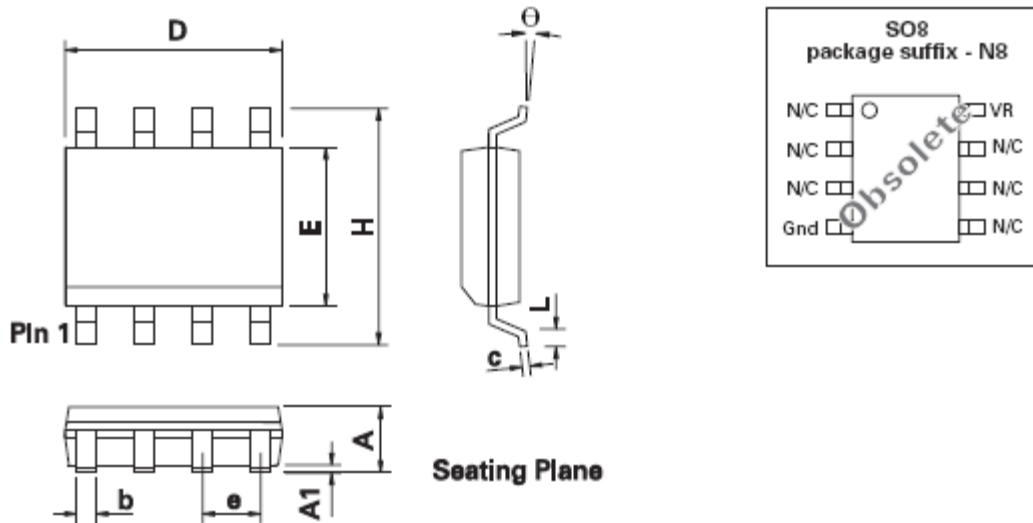

DIM	Inches		Millimeters		DIM	Inches		Millimeters	
	Min.	Max.	Min.	Max.		Min.	Max.	Min.	Max.
A	0.053	0.069	1.35	1.75	e	0.050 BSC		1.27 BSC	
A1	0.004	0.010	0.10	0.25	b	0.013	0.020	0.33	0.51
D	0.189	0.197	4.80	5.00	c	0.008	0.010	0.19	0.25
H	0.228	0.244	5.80	6.20	theta	0°	8°	0°	8°
E	0.150	0.157	3.80	4.00	h	0.010	0.020	0.25	0.50
L	0.016	0.050	0.40	1.27	-	-	-	-	-

Note: Controlling dimensions are in inches. Approximate dimensions are provided in millimeters

IMPORTANT NOTICE

DIODES INCORPORATED MAKES NO WARRANTY OF ANY KIND, EXPRESS OR IMPLIED, WITH REGARDS TO THIS DOCUMENT, INCLUDING, BUT NOT LIMITED TO, THE IMPLIED WARRANTIES OF MERCHANTABILITY AND FITNESS FOR A PARTICULAR PURPOSE (AND THEIR EQUIVALENTS UNDER THE LAWS OF ANY JURISDICTION).

Diodes Incorporated and its subsidiaries reserve the right to make modifications, enhancements, improvements, corrections or other changes without further notice to this document and any product described herein. Diodes Incorporated does not assume any liability arising out of the application or use of this document or any product described herein; neither does Diodes Incorporated convey any license under its patent or trademark rights, nor the rights of others. Any Customer or user of this document or products described herein in such applications shall assume all risks of such use and will agree to hold Diodes Incorporated and all the companies whose products are represented on Diodes Incorporated website, harmless against all damages.

Diodes Incorporated does not warrant or accept any liability whatsoever in respect of any products purchased through unauthorized sales channel.

Should Customers purchase or use Diodes Incorporated products for any unintended or unauthorized application, Customers shall indemnify and hold Diodes Incorporated and its representatives harmless against all claims, damages, expenses, and attorney fees arising out of, directly or indirectly, any claim of personal injury or death associated with such unintended or unauthorized application.

Products described herein may be covered by one or more United States, international or foreign patents pending. Product names and markings noted herein may also be covered by one or more United States, international or foreign trademarks.

LIFE SUPPORT

Diodes Incorporated products are specifically not authorized for use as critical components in life support devices or systems without the express written approval of the Chief Executive Officer of Diodes Incorporated. As used herein:

A. Life support devices or systems are devices or systems which:

1. are intended to implant into the body, or
2. support or sustain life and whose failure to perform when properly used in accordance with instructions for use provided in the labeling can be reasonably expected to result in significant injury to the user.

B. A critical component is any component in a life support device or system whose failure to perform can be reasonably expected to cause the failure of the life support device or to affect its safety or effectiveness.

Customers represent that they have all necessary expertise in the safety and regulatory ramifications of their life support devices or systems, and acknowledge and agree that they are solely responsible for all legal, regulatory and safety-related requirements concerning their products and any use of Diodes Incorporated products in such safety-critical, life support devices or systems, notwithstanding any devices- or systems-related information or support that may be provided by Diodes Incorporated. Further, Customers must fully indemnify Diodes Incorporated and its representatives against any damages arising out of the use of Diodes Incorporated products in such safety-critical, life support devices or systems.

Copyright © 2010, Diodes Incorporated

www.diodes.com



Компания «ЭлектроПласт» предлагает заключение долгосрочных отношений при поставках импортных электронных компонентов на взаимовыгодных условиях!

Наши преимущества:

- Оперативные поставки широкого спектра электронных компонентов отечественного и импортного производства напрямую от производителей и с крупнейших мировых складов;
- Поставка более 17-ти миллионов наименований электронных компонентов;
- Поставка сложных, дефицитных, либо снятых с производства позиций;
- Оперативные сроки поставки под заказ (от 5 рабочих дней);
- Экспресс доставка в любую точку России;
- Техническая поддержка проекта, помощь в подборе аналогов, поставка прототипов;
- Система менеджмента качества сертифицирована по Международному стандарту ISO 9001;
- Лицензия ФСБ на осуществление работ с использованием сведений, составляющих государственную тайну;
- Поставка специализированных компонентов (Xilinx, Altera, Analog Devices, Intersil, Interpoint, Microsemi, Aeroflex, Peregrine, Syfer, Eurofarad, Texas Instrument, Miteq, Cobham, E2V, MA-COM, Hittite, Mini-Circuits, General Dynamics и др.);

Помимо этого, одним из направлений компании «ЭлектроПласт» является направление «Источники питания». Мы предлагаем Вам помощь Конструкторского отдела:

- Подбор оптимального решения, техническое обоснование при выборе компонента;
- Подбор аналогов;
- Консультации по применению компонента;
- Поставка образцов и прототипов;
- Техническая поддержка проекта;
- Защита от снятия компонента с производства.



Как с нами связаться

Телефон: 8 (812) 309 58 32 (многоканальный)

Факс: 8 (812) 320-02-42

Электронная почта: org@eplast1.ru

Адрес: 198099, г. Санкт-Петербург, ул. Калинина, дом 2, корпус 4, литера А.