

Type DPL12 Series

Key Features

12mm rotary encoder

Incremental type

Push switch option

Various shaft lengths

LED color options

Detent Options



12mm rotary incremental encoder with LED for use in electronic equipment.

Can be supplied with or without switch with customization to standard options.

Characteristics – Electrical

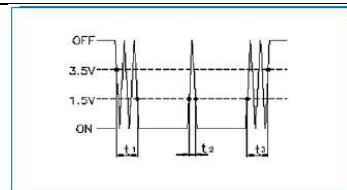

Pulse	24 / 360°
Contact Rating	0.5mA 5VDC
Dielectric Strength	300VAC / 1mA, 1 minute
Insulation Resistance (min)	100MΩ at 250VAC
Operating Speed (RPM)	60 RPM
Electrical Travel	Continuous
Rotational Noise	t ₂ = 2.0ms max (see below)
Chattering	t ₁ & t ₃ = 3.0ms max (see below)



Code off Area V=3.5V or more
Code on Area V=1.5V or less

LED	With Switch – Dual color (see below) No Switch – Single color (see below)
Color Options	Switch – 1 = Blue / Green, 2 = Blue / Orange, 3 = Green / Red No Switch – White, Red, Green, Blue
Switch Power Rating (where fitted)	5VDC 10mA
Switch contact Resistance	100MΩ max.
Operating Temperature	-10°C ~ +85°C
Storage Temperature	-40°C ~ +70°C

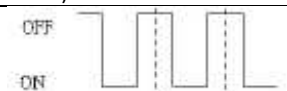
Electrical Characteristics

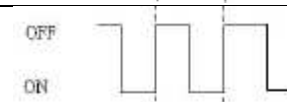
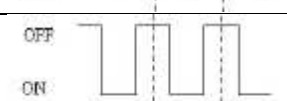
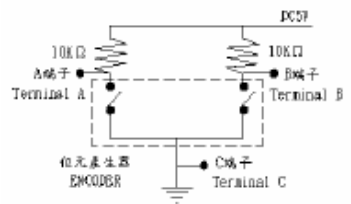
Item	Conditions		Specifications
Output Signal Format			2 Phase different signals (signal A & signal B) Details shown below (broken line shows detent position where fitted)
	C/W	A (Terminal A-C)	
		B (Terminal B-C)	
	C C/W	A (Terminal A-C)	
B (Terminal B-C)			
Resolution	Number of pulses in 360° rotation		24 pulses / 360° each phase
Switching Characteristics	Measurement shall be made under the following conditions: 1. Shaft rotational speed: 360°/S 2. Test Circuit: See below 		
Sliding Noise	Chattering Specified by the signal's passage time from 3.5V to 1.5V or from 1.5V to 3.5V of each switching position (Code OFF → ON or ON → OFF) NB To avoid chattering ($t_1 - t_3$) please consider masking time and adding C/R filters to your circuit for pulse count design.		$t_1, t_3 \leq 3\text{ms}$
	Bounce Specified by the time of voltage change exceed 1.5V in code ON area. When the bounce has code ON time less than 1ms between chattering (t_1 or t_3) the voltage change shall be regarded as part of chattering, When the code ON time between two bounces is less than 1ms they are regarded as one linked bounce		$T_2 \leq 2\text{ms}$

<p>Sliding Noise (continued)</p> 	<p>Sliding Noise The voltage change in OFF area</p> 	<p>3.5V min.</p>
<p>(t₁, t₃) Masking time to avoid chattering Code OFF area – The area in which the voltage is 3.5V or more Code ON area – The area in which the voltage is 1.5V or less</p>		
<p>Phase Difference</p>	<p>Measurement shall be made in the condition in which the shaft is rotated in 360° / S (constant speed)</p> <p>Rotational direction</p>  <p>Rotational Direction →</p> <p>Note: The test is conducted using equipment at constant speed 360° / S according to spec. The test result could be different under manual conditions. In order to prove the interoperability between the firmware and the encoder please test the part in real conditions</p>	<p>$\Delta T \geq 3.5\text{msec}$</p>
<p>Insulation Resistance</p>	<p>Measurement shall be made under the condition which a voltage of 250V D.C is applied between individual terminals and attaching plate</p>	<p>Between individual terminals and attaching Plate:100MΩ MIN</p>
<p>Dielectric Strength</p>	<p>A voltage of 300V A.C. shall be applied for 1 min or a voltage of 360 VA.C. shall be applied for 2 sec between individual terminals and attaching plate (Leak current : 1mA)</p>	<p>Without arcing or breakdown</p>
<p>Number and position of detents</p>		<p>24 detents Step angle: 15°±3°</p>
<p>Terminal Strength</p>	<p>Push and pull static load of 5Kgf shall be applied to the shaft in the axial direction for 10sec. (After soldering of the PC board)</p>	<p>Without damage to. or excessive play in shaft .No excessive abnormality in rotational feeling and electrical characteristics shall be satisfied.</p>
<p>Rotation play at the click position</p>	<p>Measure with jig for rotational angle</p>	<p>4°Max</p>

Endurance Characteristics

Item	Conditions	Specification
Rotational Life	The shaft of the encoder shall be rotated to 30,000 cycles at a speed of 600 ~ 1000 cycles per hour without electrical load, after which measurement shall be made (1 cycle : rotate 360° C.C.W. rotate 360° C.W.)	Chattering: $t_1, t_3 \leq 5\text{ms}$ Bounce: $t_2 \leq 3\text{ms}$ Phase-difference: $\Delta T \geq 2.5\text{msec}$ Where applicable detent feeling remains. All electrical specification shall be met

Soldering Condition

Item	Conditions	Specifications
Hand Soldering	Bit temperature: 350°C or less Dwell time: 3S max.	There shall be no deformation or cracks in molded part. No excessive abnormality in rotational feeling
Dip soldering	Preheating: PCB surface temp: 100°C or less Preheating time: 2 minutes Max. Soldering: Solder temperature: 260°C±5°C Immersion time: 5±1S 2 times max.	

Switch Electrical Characteristics (Where fitted)

Item	Conditions	Specification
Contact resistance	Measured by the electric current D.C. voltage drop method	100 mΩ MAX
Chattering	Switch is operated at the rate of 1 cycle 1 sec. The 1 cycle shall be OFF - ON - OFF	Less than 10 msec
Insulation Resistance	Measurement shall be made under the condition which a voltage of 250V D.C. is applied between individual terminals and attaching plate.	Between individual terminals and attaching plate. 100MΩ MIN .
Dielectric Strength	A voltage of 300V A.C. shall be applied for 1 min. or a voltage of 360V A.C. shall be applied for 2 sec between individual terminals and attaching plate. (Leak current : 1mA)	Without damage to parts arcing or breakdown.
Switch rating (Resistor load)		D.C.5V 10mA
Note	Shaft is insulated from switch terminal	

Switch Mechanical Characteristics (Where fitted)

Item	Conditions	Specification
Contact arrangement		S.P.S.T Push On
Switching stroke		0.5+0/-0.3mm

Switch Mechanical Characteristics (Continued)

Item	Conditions	Specification
Switch strength		450 ± 200gf

Switch Endurance Characteristics

Item	Conditions	Specification
Operating life	The shaft of switch shall be operated 20,000 times without electronic load, after which measurements shall be made	Switch contact resistance : 200mΩ MAX Switch strength: Relative to the previously Specified value +10% / -30%. Except above items specification as shown above

LED Common Specifications

Single color (No Switch)

Circuit



LED Characteristics

Reverse Voltage: 5V

Emitted Colour	Power Dissipation	DC Forward Current	Test Conditions IF = 20mA	
			Forward Voltage (V)	
			Typ.	Max.
Red	60mW	30mA	1.8	2.6
Lawn Green	100mW	30mA	2	2.6
Blue	72mW	20mA	3.2	3.6
Orange	100mW	30mA	2.1	2.6
White	72mW	20mA	3.2	3.6
Green	72mW	20mA	3.2	3.6
Dark Orange	100mW	30mA	2.1	2.6

Shaft Length – Without Switch

Type	Dim	Options (mm)		
K	L (from mounting surface)	24 only		
F	L (from mounting surface)	17.5	20	25
	F	5	7	12

Shaft Length – With Switch

Type	Dim	Options (mm)		
K	L (from mounting surface)	25 only		
F	L (from mounting surface)	18.5	21	26
	F	5	7	12

LED Color Codes

Switch Option	Code	Description
Switch (Dual Color)	1	Blue / Green
	2	Blue / Orange
	3	Green / Red
	4	Red / Green
	5	Green / Orange
	6	Blue / Red
	7	White / Red
	8	White / Green
No Switch (Single Color)	R	Red
	L	Lawn Green
	B	Blue
	O	Orange
	W	White
	G	Green
	D	Dark Orange

How To Order

DPL12	V	N	24	A	20	F	R
Common Part	Orientation	Detent	Pulses	Bush	Shaft Length	Shaft Style	LED Color
DPL12 – No Switch DPL12S – Switch	V – Vertical H – Horizontal	N – None 24 – 24 clicks	24 – 24 pulses	5mm	See relevant table	F – Flatted K – Knurled	See relevant table



Компания «ЭлектроПласт» предлагает заключение долгосрочных отношений при поставках импортных электронных компонентов на взаимовыгодных условиях!

Наши преимущества:

- Оперативные поставки широкого спектра электронных компонентов отечественного и импортного производства напрямую от производителей и с крупнейших мировых складов;
- Поставка более 17-ти миллионов наименований электронных компонентов;
- Поставка сложных, дефицитных, либо снятых с производства позиций;
- Оперативные сроки поставки под заказ (от 5 рабочих дней);
- Экспресс доставка в любую точку России;
- Техническая поддержка проекта, помощь в подборе аналогов, поставка прототипов;
- Система менеджмента качества сертифицирована по Международному стандарту ISO 9001;
- Лицензия ФСБ на осуществление работ с использованием сведений, составляющих государственную тайну;
- Поставка специализированных компонентов (Xilinx, Altera, Analog Devices, Intersil, Interpoint, Microsemi, Aeroflex, Peregrine, Syfer, Eurofarad, Texas Instrument, Miteq, Cobham, E2V, MA-COM, Hittite, Mini-Circuits, General Dynamics и др.);

Помимо этого, одним из направлений компании «ЭлектроПласт» является направление «Источники питания». Мы предлагаем Вам помощь Конструкторского отдела:

- Подбор оптимального решения, техническое обоснование при выборе компонента;
- Подбор аналогов;
- Консультации по применению компонента;
- Поставка образцов и прототипов;
- Техническая поддержка проекта;
- Защита от снятия компонента с производства.



Как с нами связаться

Телефон: 8 (812) 309 58 32 (многоканальный)

Факс: 8 (812) 320-02-42

Электронная почта: org@eplast1.ru

Адрес: 198099, г. Санкт-Петербург, ул. Калинина, дом 2, корпус 4, литера А.