

DATA SHEET

TRANSIENT VOLTAGE SUPPRESSORS

AC/DC POWER SUPPLY

P4KE series

RoHS compliant & Halogen free



Product specification— April 29, 2019 V.0



Transient Voltage Suppressors (TVS) Data Sheet

Features

- Glass passivated junction
- Low inductance
- Excellent clamping capability
- 400W peak pulse power capability at 10/1000 μ s waveform, repetition rate (duty cycle): 0.01%
- Fast response time
- Typical I_R less than 1 μ A above 12V
- High Temperature soldering guaranteed: 265 $^{\circ}$ C/10 seconds/.375", (9.5mm) lead length, 5lbs (2.3kg) tension
- Plastic package has underwriters laboratory flammability 94V-0
- Meets MSL level 1, per J-STD-020
- Safety certification: UL: E244458



Mechanical Data

- Case: JEDEC DO-41 Moulded plastic
- Terminal: Axial leads, solderable per MIL-STD-750, Method 2026
- Polarity: Color band denotes cathode except bi-directional models
- Mounting Position: Any
- Weight: 0.33g

Applications

- I/O interface
- AC/DC power supply
- Low frequency signal transmission line (RS232, RS485, etc.)

Maximum Ratings and Characteristics

Ratings at 25 $^{\circ}$ C ambient temperature unless otherwise specified.

Rating	Symbol	Value	Units
Peak pulse power dissipation at 10/1000 μ s waveform (Note1, Note2, Fig.1)	P_{PPM}	Minimum 400	Watts
Peak pulse current of at 10/1000 μ s waveform (Note 1, Fig.3)	I_{PPM}	See Table	Amps
Steady state power dissipation at $T_A=50^{\circ}$ C (Fig.5)	$P_{M(AV)}$	1.5	Watts
Peak forward surge current, 8.3ms single half sine-wave superimposed on rated load, (JEDEC Method) (Note3, Fig.6)	I_{FSM}	40	Amps
Operating junction and Storage Temperature Range.	T_J, T_{STG}	-65 to +150	$^{\circ}$ C
Typical thermal resistance junction to lead	$R_{\theta JL}$	60	$^{\circ}$ C/W
Typical thermal resistance junction to ambient	$R_{\theta JA}$	100	$^{\circ}$ C/W

Notes: 1. Non-repetitive current pulse, per Fig.3 and derated above $T_A=25^{\circ}$ C per Fig.2.

2. 8.3ms single half sine-wave, or equivalent square wave, duty cycle=4 pulses per minutes maximum.

Dimensions (DO-204AL/DO-41)

	Symbol	Millimeters		Inches	
		Min.	Max.	Min.	Max.
L	25.40	-	1.000	-	
T	4.10	5.20	0.160	0.205	
d	2.00	2.70	0.080	0.107	
s	0.71	0.86	0.028	0.034	

Part Number Code

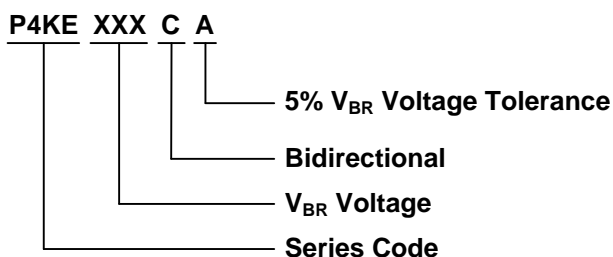

Ordering Code for different package

Box package: Add suffix “/B” at the end of the part number, such as P4KE10A/B

Reel package: Add suffix “/TR13” at the end of the part number, such as P4KE68CA/TR13

Electrical Characteristics ($T_A=25^{\circ}C$)

Part Number		Reverse Stand-Off Voltage	Breakdown Voltage @ I_T	Test Current	Maximum Clamping Voltage @ I_{PP}	Peak Pulse Current	Reverse Leakage @ V_{RWM}
Unidirectional	Bidirectional	$V_{RWM}(V)$	$V_{BR}(V)$	$I_T(mA)$	$V_C(V)$	$I_{PP}(A)$	$I_R(\mu A)$
P4KE6.8A	P4KE6.8CA	5.80	6.45~7.14	10	10.5	39.0	1000
P4KE7.5A	P4KE7.5CA	6.40	7.13~7.88	10	11.3	36.3	500
P4KE8.2A	P4KE8.2CA	7.02	7.79~8.61	10	12.1	33.9	200
P4KE9.1A	P4KE9.1CA	7.78	8.65~9.55	1	13.4	30.6	50
P4KE10A	P4KE10CA	8.55	9.50~10.50	1	14.5	28.3	10
P4KE11A	P4KE11CA	9.40	10.50~11.60	1	15.6	26.3	5
P4KE12A	P4KE12CA	10.20	11.40~12.60	1	16.7	24.6	5
P4KE13A	P4KE13CA	11.10	12.40~13.70	1	18.2	22.5	1
P4KE15A	P4KE15CA	12.80	14.30~15.80	1	21.2	19.3	1
P4KE16A	P4KE16CA	13.60	15.20~16.80	1	22.5	18.2	1
P4KE18A	P4KE18CA	15.30	17.10~18.90	1	25.2	16.1	1
P4KE20A	P4KE20CA	17.10	19.00~21.00	1	27.7	14.8	1
P4KE22A	P4KE22CA	18.80	20.90~23.10	1	30.6	13.4	1
P4KE24A	P4KE24CA	20.50	22.80~25.20	1	33.2	12.3	1

Transient Voltage Suppressors P4KE

Part Number		Reverse Stand-Off Voltage	Breakdown Voltage @ I_T	Test Current	Maximum Clamping Voltage @ I_{PP}	Peak Pulse Current	Reverse Leakage @ V_{RWM}
Unidirectional	Bidirectional	$V_{RWM}(V)$	$V_{BR}(V)$	$I_T(mA)$	$V_C(V)$	$I_{PP}(A)$	$I_R(\mu A)$
P4KE27A	P4KE27CA	23.10	25.70~28.40	1	37.5	10.9	1
P4KE30A	P4KE30CA	25.60	28.50~31.50	1	41.4	9.9	1
P4KE33A	P4KE33CA	28.20	31.40~34.70	1	45.7	9.0	1
P4KE36A	P4KE36CA	30.80	34.20~37.80	1	49.9	8.2	1
P4KE39A	P4KE39CA	33.30	37.10~41.00	1	53.9	7.6	1
P4KE43A	P4KE43CA	36.80	40.90~45.20	1	59.3	6.9	1
P4KE47A	P4KE47CA	40.20	44.70~49.40	1	64.8	6.3	1
P4KE51A	P4KE51CA	43.60	48.50~53.60	1	70.1	5.8	1
P4KE56A	P4KE56CA	47.80	53.20~58.80	1	77.0	5.3	1
P4KE62A	P4KE62CA	53.00	58.90~65.10	1	85.0	4.8	1
P4KE68A	P4KE68CA	58.10	64.60~71.40	1	92.0	4.5	1
P4KE75A	P4KE75CA	64.10	71.30~78.80	1	103.0	4.0	1
P4KE82A	P4KE82CA	70.10	77.90~86.10	1	113.0	3.6	1
P4KE91A	P4KE91CA	77.80	86.50~95.50	1	125.0	3.3	1
P4KE100A	P4KE100CA	85.50	95.00~105.00	1	137.0	3.0	1
P4KE110A	P4KE110CA	94.00	105.00~116.00	1	152.0	2.7	1
P4KE120A	P4KE120CA	102.00	114.00~126.00	1	165.0	2.5	1
P4KE130A	P4KE130CA	111.00	124.00~137.00	1	179.0	2.3	1
P4KE150A	P4KE150CA	128.00	143.00~158.00	1	207.0	2.0	1
P4KE160A	P4KE160CA	136.00	152.00~168.00	1	219.0	1.9	1
P4KE170A	P4KE170CA	145.00	162.00~179.00	1	234.0	1.8	1
P4KE180A	P4KE180CA	154.00	171.00~189.00	1	246.0	1.7	1
P4KE200A	P4KE200CA	171.00	190.00~210.00	1	274.0	1.5	1
P4KE220A	P4KE220CA	185.00	209.00~231.00	1	328.0	1.3	1
P4KE250A	P4KE250CA	214.00	237.00~263.00	1	344.0	1.2	1
P4KE300A	P4KE300CA	256.00	285.00~315.00	1	414.0	1.0	1
P4KE350A	P4KE350CA	300.00	332.00~368.00	1	482.0	0.85	1
P4KE400A	P4KE400CA	342.00	380.00~420.00	1	548.0	0.75	1
P4KE440A	P4KE440CA	376.00	418.00~462.00	1	602.0	0.68	1
P4KE480A	P4KE480CA	408.00	456.00~504.00	1	658.0	0.61	1
P4KE510A	P4KE510CA	434.00	485.00~535.00	1	698.0	0.57	1
P4KE530A	P4KE530CA	450.00	503.50~556.50	1	725.0	0.55	1
P4KE540A	P4KE540CA	459.00	513.00~567.00	1	740.0	0.54	1
P4KE550A	P4KE550CA	467.00	522.50~577.50	1	760.0	0.52	1

Notes: For bidirectional type having V_{RWM} of 10V and less, the I_R limit is double.

Ratings and Characteristic Curves ($T_A=25^{\circ}\text{C}$ unless otherwise noted)

Figure 1. Peak Pulse Power Rating Curve

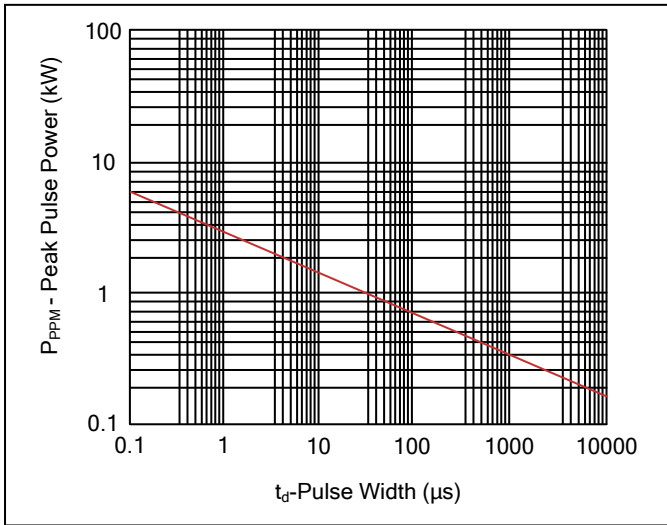

Figure 2. Pulse Derating Curve

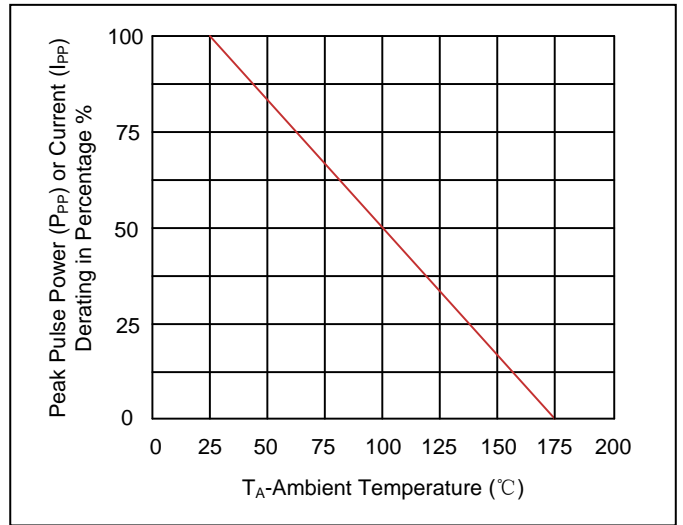

Figure 3. Pulse Waveform

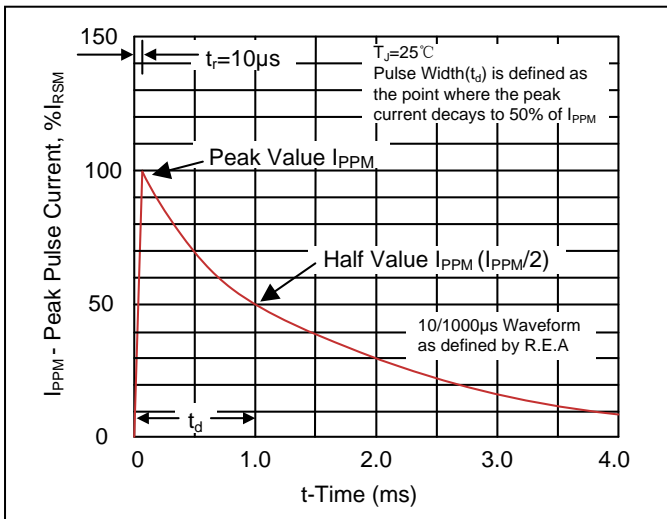

Figure 4. Typical Junction Capacitance

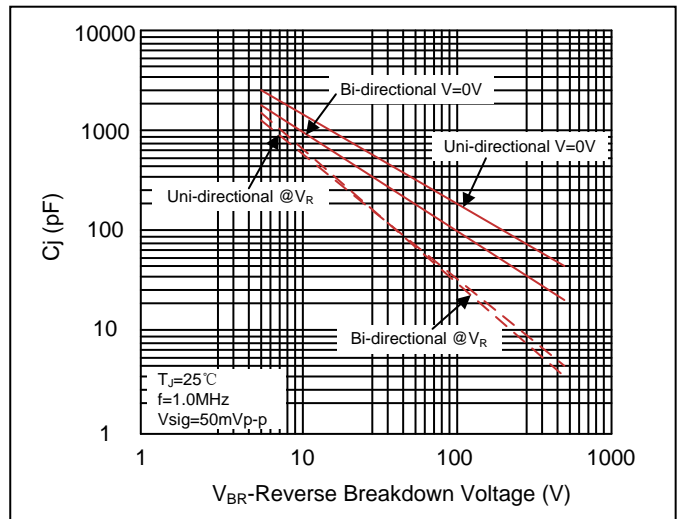

Figure 5. Steady State Power Dissipation Derating Curve

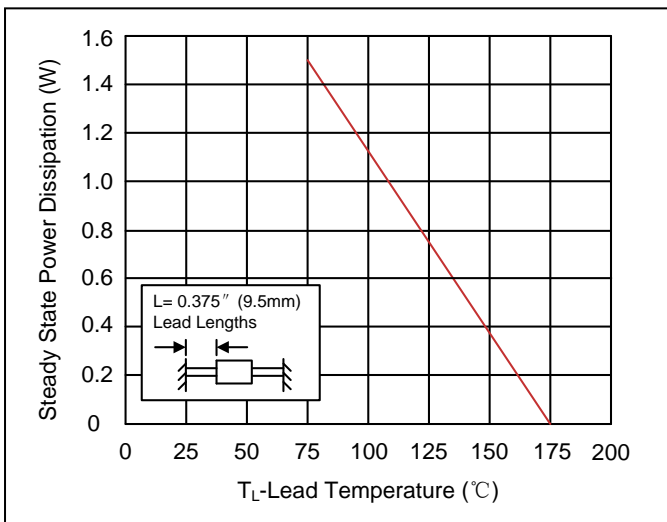
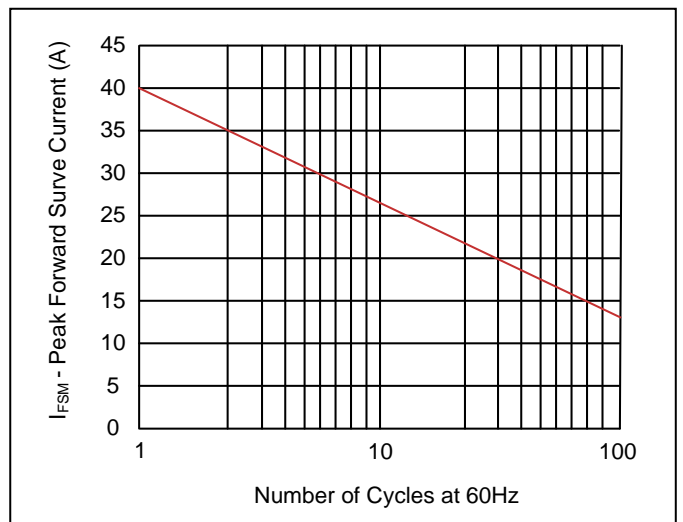
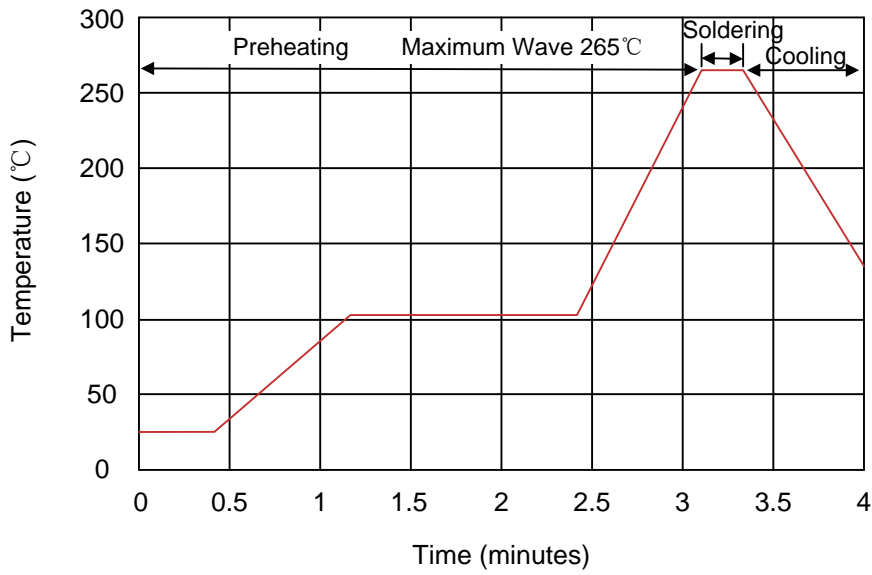

Figure 6. Maximum Non-Repetitive Forward Surge Current Uni-Directional Only



Recommended Soldering Conditions

Wave Soldering



Recommended Conditions

Item	Conditions
Peak Temperature	265°C
Dipping Time	10 seconds
Soldering	1 time

Marking Code

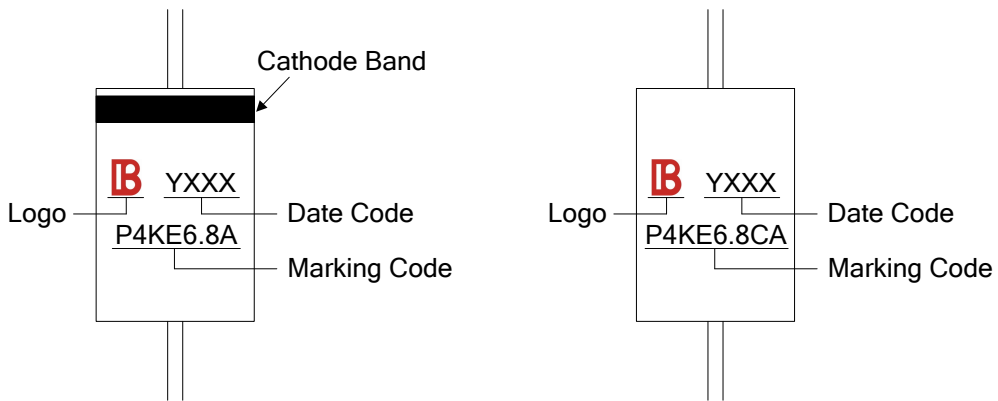

Packaging

Tape	Symbol	Dimension (mm)
	A	5.0±0.5
	B	53.0±1.0
	Z	1.2Max.
	T	6.0±0.4
	E	0.8Max.
	L1-L2	1.0Max.
		L
W		75.0±5.0
H		114.0±5.0
Quantity: 3000PCS		
	D	330.0±3.0
	D0	16.4±2.0
	D1	86.0±2.0
	W1	76.0±3.0
	Quantity: 5000PCS	



Компания «ЭлектроПласт» предлагает заключение долгосрочных отношений при поставках импортных электронных компонентов на взаимовыгодных условиях!

Наши преимущества:

- Оперативные поставки широкого спектра электронных компонентов отечественного и импортного производства напрямую от производителей и с крупнейших мировых складов;
- Поставка более 17-ти миллионов наименований электронных компонентов;
- Поставка сложных, дефицитных, либо снятых с производства позиций;
- Оперативные сроки поставки под заказ (от 5 рабочих дней);
- Экспресс доставка в любую точку России;
- Техническая поддержка проекта, помощь в подборе аналогов, поставка прототипов;
- Система менеджмента качества сертифицирована по Международному стандарту ISO 9001;
- Лицензия ФСБ на осуществление работ с использованием сведений, составляющих государственную тайну;
- Поставка специализированных компонентов (Xilinx, Altera, Analog Devices, Intersil, Interpoint, Microsemi, Aeroflex, Peregrine, Syfer, Eurofarad, Texas Instrument, Miteq, Cobham, E2V, MA-COM, Hittite, Mini-Circuits, General Dynamics и др.);

Помимо этого, одним из направлений компании «ЭлектроПласт» является направление «Источники питания». Мы предлагаем Вам помощь Конструкторского отдела:

- Подбор оптимального решения, техническое обоснование при выборе компонента;
- Подбор аналогов;
- Консультации по применению компонента;
- Поставка образцов и прототипов;
- Техническая поддержка проекта;
- Защита от снятия компонента с производства.



Как с нами связаться

Телефон: 8 (812) 309 58 32 (многоканальный)

Факс: 8 (812) 320-02-42

Электронная почта: org@eplast1.ru

Адрес: 198099, г. Санкт-Петербург, ул. Калинина, дом 2, корпус 4, литера А.