

# Optocoupler, Phototriac Output, Non-Zero Crossing, 1.5 kV/μs dV/dt, 600 V

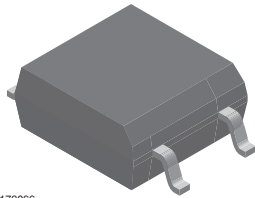

1179066

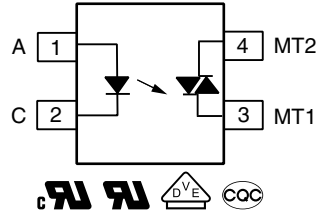

## FEATURES

- High static dV/dt > 1.5 kV/μs
- Input sensitivity  $I_{FT} = 5 \text{ mA}$  and  $10 \text{ mA}$
- On-state RMS current  $I_{T(RMS)} = 70 \text{ mA}$
- 600 V peak off-state blocking voltage
- Isolation test voltage  $3750 \text{ V}_{RMS}$
- Material categorization:  
For definitions of compliance please see [www.vishay.com/doc?99912](http://www.vishay.com/doc?99912)



## DESCRIPTION

The VOM3052 and VOM3053 phototriac consist a GaAs IRLED optically coupled to a photosensitive non-zero crossing TRIAC packaged in a SOP-4 package. It has a LED trigger current of 5 mA for VOM3053 and 10 mA for VOM3052.

The VOM3052 and VOM3053 phototriac isolate low-voltage logic from 120 V<sub>AC</sub>, 240 V<sub>AC</sub>, and 380 V<sub>AC</sub> lines to control resistive, inductive, or capacitive loads including motors, solenoids, high current thyristors or TRIAC and relays.

## APPLICATIONS

- Consumer appliances
- Triac drives
- Solid-state relays
- Industrial controls
- Office equipment
- Lighting controls

## AGENCY APPROVALS

- UL1577, file no. E52744, double protection
- cUL-file no. E52744, equivalent to CSA bulletin 5A
- VDE 0884-5, DIN EN 60747-5-5
- CQC: GB8898, GB4943

| ORDERING INFORMATION  |                          |               |
|---|--------------------------|---------------|
| <div style="display: flex; justify-content: space-around; align-items: center;"> <div style="border: 1px solid black; padding: 2px 5px;">V</div> <div style="border: 1px solid black; padding: 2px 5px;">O</div> <div style="border: 1px solid black; padding: 2px 5px;">M</div> <div style="border: 1px solid black; padding: 2px 5px;">3</div> <div style="border: 1px solid black; padding: 2px 5px;">0</div> <div style="border: 1px solid black; padding: 2px 5px;">5</div> <div style="border: 1px solid black; padding: 2px 5px;">X</div> <div style="border: 1px solid black; padding: 2px 5px;">T</div> </div> <p style="text-align: center; margin-top: 5px;">PART NUMBER</p> |                          |               |
| AGENCY CERTIFIED/PACKAGE  | TRIGGER CURRENT $I_{FT}$ |               |
| UL, cUL, CQC  | 5 mA                     | 10 mA         |
| SOP-4   | VOM3053T                 | VOM3052T      |
| VDE, UL, cUL, CQC   | 5 mA                     | 10 mA         |
| SOP-4   | VOM3053-X001T            | VOM3052-X001T |

### Notes

- For additional information on the available options refer to option information.
- The product is available only on tape and reel.



| ABSOLUTE MAXIMUM RATINGS ( $T_{amb} = 25\text{ }^{\circ}\text{C}$ , unless otherwise specified) |                             |      |              |               |                    |
|---|-----------------------------|------|--------------|---------------|--------------------|
| PARAMETER   | TEST CONDITION              | PART | SYMBOL       | VALUE         | UNIT               |
| <b>INPUT</b>  |                             |      |              |               |                    |
| Reverse voltage   |                             |      | $V_R$        | 6             | V                  |
| Forward current   |                             |      | $I_F$        | 60            | mA                 |
| Peak surge current  | 100 $\mu\text{s}$ , 200 pps |      | $I_{FSM}$    | 0.5           | A                  |
| Power dissipation   |                             |      | $P_{diss}$   | 100           | mW                 |
| <b>OUTPUT</b>   |                             |      |              |               |                    |
| Peak off-state voltage  |                             |      | $V_{DRM}$    | 600           | V                  |
| RMS on-state current  |                             |      | $I_{T(RMS)}$ | 70            | mA                 |
| Peak non-repetitive surge current   | PW = 100 ms, 120 pps        |      | $I_{TSM}$    | 1             | A                  |
| Power dissipation   |                             |      | $P_{diss}$   | 200           | mW                 |
| <b>COUPLER</b>  |                             |      |              |               |                    |
| Isolation test voltage  | t = 1 min                   |      | $V_{ISO}$    | 3750          | $V_{RMS}$          |
| Power dissipation   |                             |      | $P_{tot}$    | 300           | mW                 |
| Storage temperature range   |                             |      | $T_{stg}$    | - 55 to + 150 | $^{\circ}\text{C}$ |
| Ambient temperature range   |                             |      | $T_{amb}$    | - 40 to + 100 | $^{\circ}\text{C}$ |
| Soldering temperature <sup>(1)</sup>  |                             |      | $T_{sld}$    | 260           | $^{\circ}\text{C}$ |

Notes

- Stresses in excess of the Absolute Maximum Ratings can cause permanent damage to the device. Functional operation of the device is not implied at these or any other conditions in excess of those given in the operational sections of this document. Exposure to Absolute Maximum Ratings for extended periods of the time can adversely affect reliability.
- <sup>(1)</sup> Refer to "Assembly Instructions" for surface mounted devices ([www.vishay.com/doc?80054](http://www.vishay.com/doc?80054)).

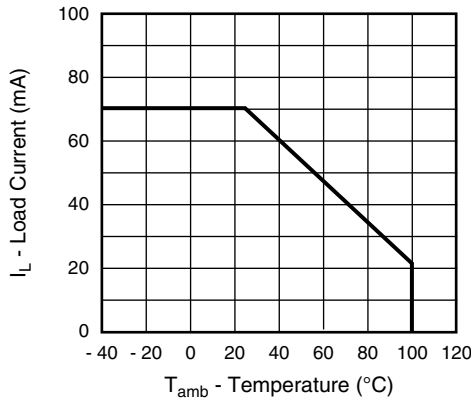

Fig. 1 - Recommended Operating Condition



| <b>ELECTRICAL CHARACTERISTICS</b> ( $T_{amb} = 25\text{ }^{\circ}\text{C}$ , unless otherwise specified) |   |         |               |      |      |      |                  |
|--|---|---------|---------------|------|------|------|------------------|
| PARAMETER  | TEST CONDITION  | PART    | SYMBOL        | MIN. | TYP. | MAX. | UNIT             |
| <b>INPUT</b>   |   |         |               |      |      |      |                  |
| Forward voltage  | $I_F = 10\text{ mA}$                                      |         | $V_F$         |      | 1.2  | 1.5  | V                |
| Reverse current  | $V_R = 6\text{ V}$  |         | $I_R$         |      |      | 10   | $\mu\text{A}$    |
| Input capacitance  | $V_F = 0\text{ V}$ , $f = 1\text{ MHz}$                   |         | $C_I$         |      | 25   |      | pF               |
| <b>OUTPUT</b>  |   |         |               |      |      |      |                  |
| Off-state current  | $V_D = V_{DRM}$   |         | $I_{DRM}$     |      |      | 100  | nA               |
| On-state voltage   | $I_T = 100\text{ mA}$                                     |         | $V_{TM}$      |      |      | 3    | V                |
| Critical rate of rise off-state voltage  | $V_D = 0.67 V_{DRM}$ , $T_J = 25\text{ }^{\circ}\text{C}$ |         | $dV/dt_{cr}$  | 1500 |      |      | V/ $\mu\text{s}$ |
| Critical rate of rise of voltage at current commutation  |   |         | $dV/dt_{crq}$ |      | 0.13 |      | V/ $\mu\text{s}$ |
| <b>COUPLER</b>   |   |         |               |      |      |      |                  |
| LED trigger current, current required to latch output  | $V_D = 3\text{ V}$  | VOM3053 | $I_{FT}$      |      |      | 5    | mA               |
|  |   | VOM3052 | $I_{FT}$      |      |      | 10   | mA               |
| Capacitance (input - output)   | $f = 1\text{ MHz}$ , $V_{IO} = 0\text{ V}$                |         | $C_{IO}$      |      | 0.8  |      | pF               |
| Peak off-state voltage   | $I_C = 100\text{ }\mu\text{A}$                            |         | $V_{DRM}$     | 600  |      |      | V                |
| Holding current  |   |         | $I_{hold}$    |      | 0.3  |      | mA               |

**Note**

- Minimum and maximum values were tested requirements. Typical values are characteristics of the device and are the result of engineering evaluations. Typical values are for information only and are not part of the testing requirements.

| <b>SAFETY AND INSULATION RATINGS</b>  |            |           |           |      |                    |  |
|---|------------|-----------|-----------|------|--------------------|--|
| PARAMETER   | SYMBOL     | MIN.      | TYP.      | MAX. | UNIT               |  |
| Climatic classification (according to IEC 68 part 1)                                      |            |           | 40/100/21 |      |                    |  |
| Pollution degree (DIN VDE 0109)   |            |           | 2         |      |                    |  |
| Comparative tracking index  | CTI        | 175       |           | 399  |                    |  |
| Peak transient overvoltage  | $V_{IOTM}$ |           |           | 6000 | $V_{peak}$         |  |
| Peak insulation voltage   | $V_{IORM}$ |           |           | 707  | $V_{peak}$         |  |
| Isolation resistance at $T_{amb} = 100\text{ }^{\circ}\text{C}$ , $V_{DC} = 500\text{ V}$ | $R_{IO}$   | $10^{11}$ |           |      | $\Omega$           |  |
| Isolation resistance at $T_{amb} = 25\text{ }^{\circ}\text{C}$ , $V_{DC} = 500\text{ V}$  | $R_{IO}$   | $10^{12}$ |           |      | $\Omega$           |  |
| Safety rating - power   | $P_{SO}$   |           |           | 400  | mW                 |  |
| Safety rating - input current   | $I_{SI}$   |           |           | 150  | mA                 |  |
| Safety rating - temperature   | $T_{SI}$   |           |           | 165  | $^{\circ}\text{C}$ |  |
| Creepage distance   |            | 5         |           |      | mm                 |  |
| Clearance distance  |            | 5         |           |      | mm                 |  |
| Insulation thickness  |            | 0.4       |           |      | mm                 |  |

**TYPICAL CHARACTERISTICS** ( $T_{amb} = 25\text{ }^{\circ}\text{C}$ , unless otherwise specified)

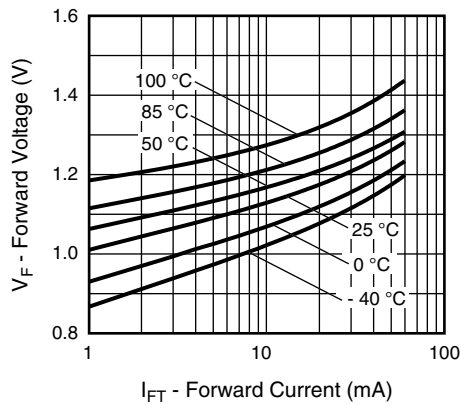

Fig. 2 - Forward Current vs. Forward Voltage

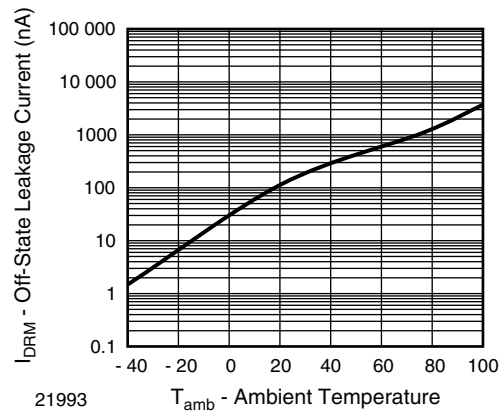

Fig. 5 - Off-State Leakage Current vs. Ambient Temperature

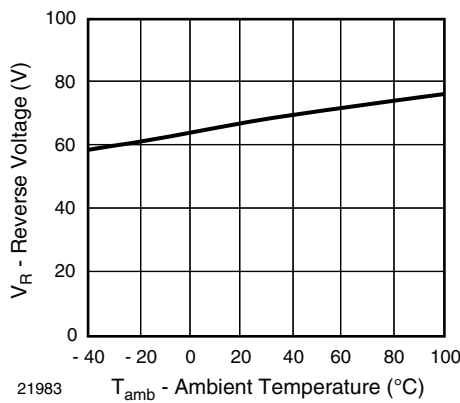

Fig. 3 - Reverse Voltage vs. Ambient Temperature

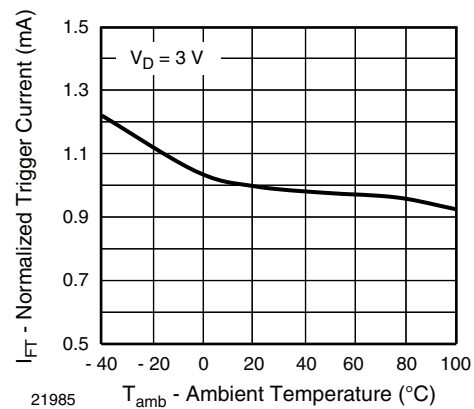

Fig. 6 - Normalized Trigger Current vs. Ambient Temperature

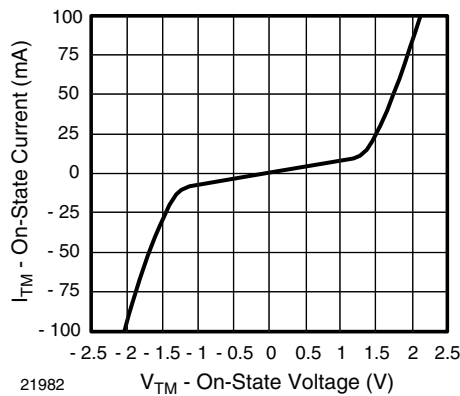

Fig. 4 - On-State Current vs. On-State Voltage

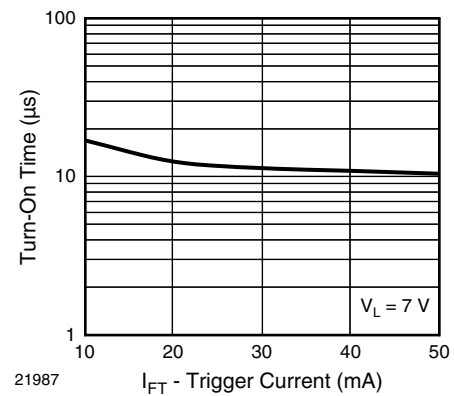

Fig. 7 - Trigger Current vs. Turn-On Time

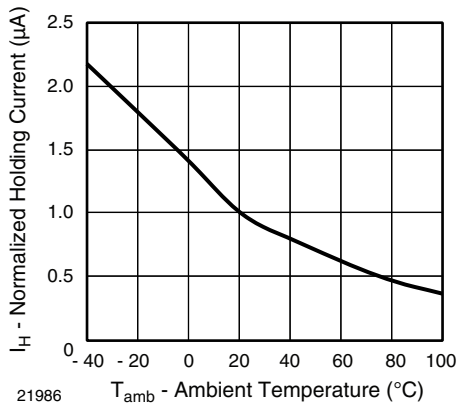

Fig. 8 - Normalized Holding Current vs. Ambient Temperature

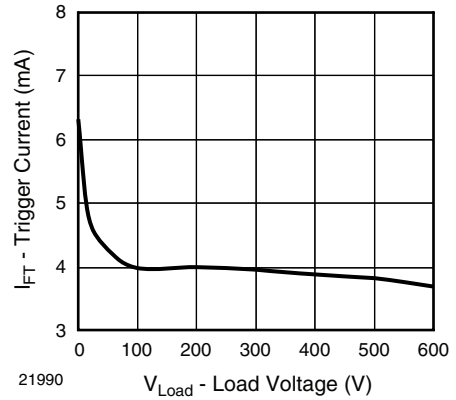

Fig. 11 - Trigger Current vs. Load Voltage

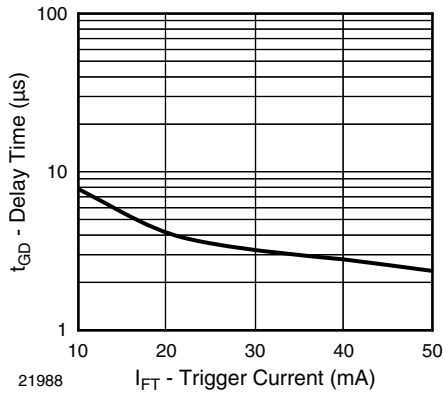

Fig. 9 - Trigger Current vs. Delay Time

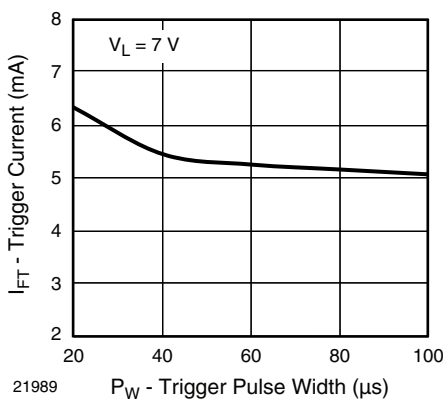
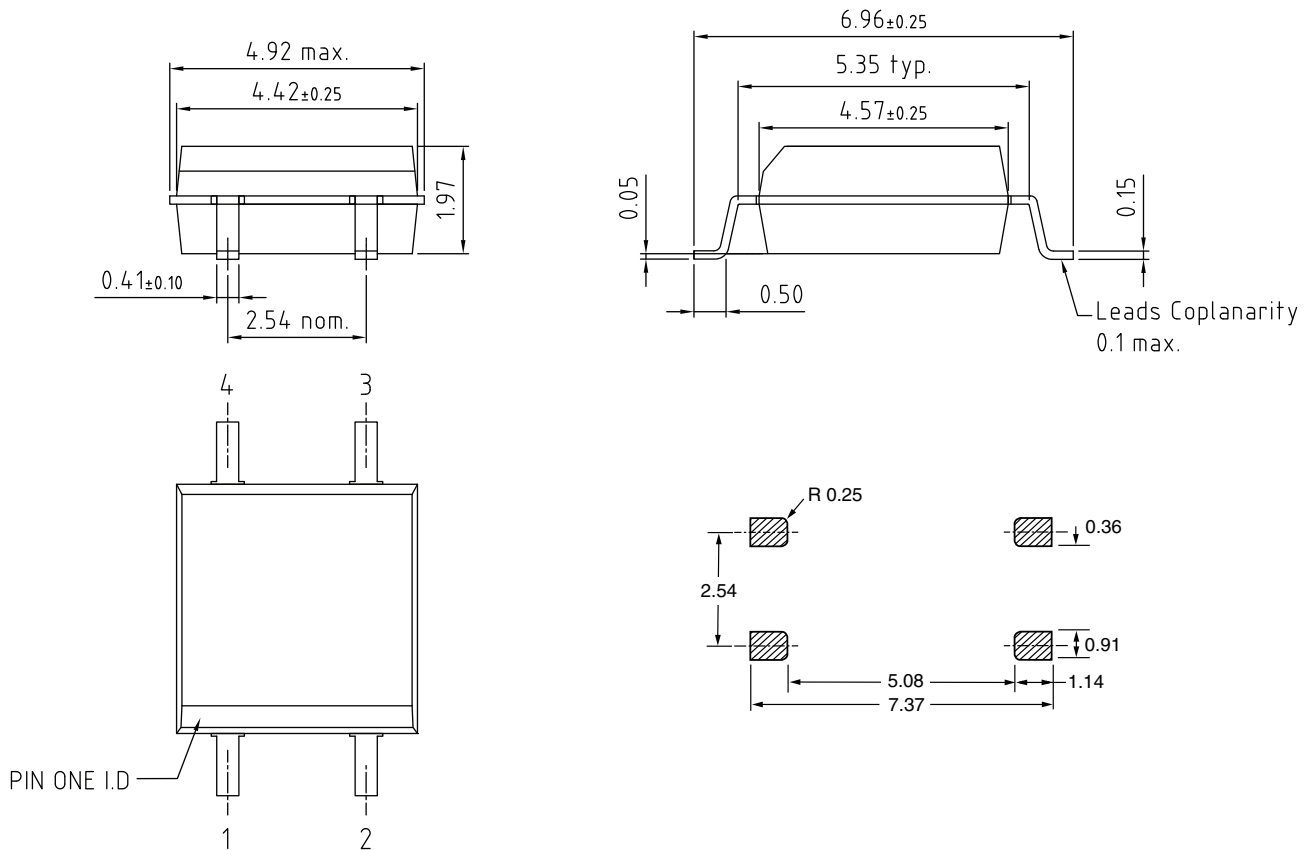
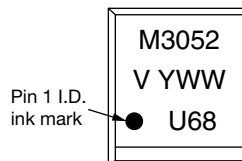

Fig. 10 - Trigger Current vs. Trigger Pulse Width

**PACKAGE DIMENSIONS** in millimeters



**PACKAGE MARKING** (example)



**TAPE AND REEL PACKAGING**

Dimensions in millimeters

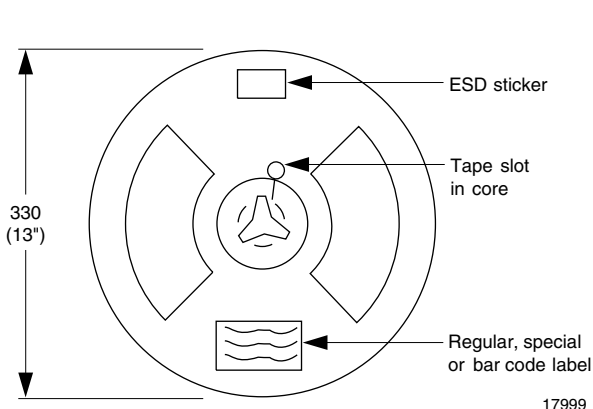

Fig. 12 - Tape and Reel Shipping Medium, 2000 units per reel

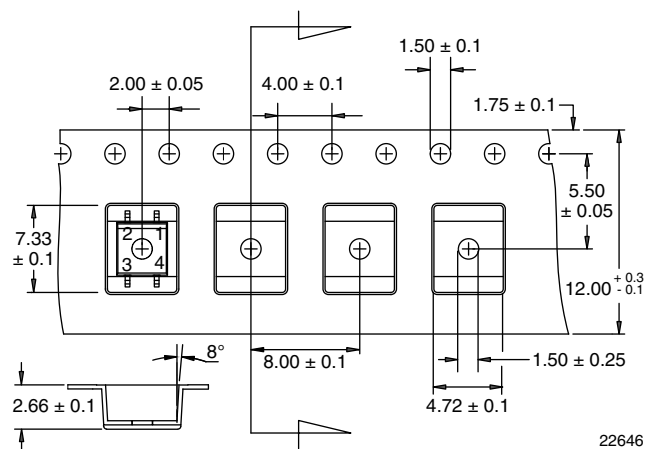

Fig. 13 - Tape Dimensions



## Disclaimer

ALL PRODUCT, PRODUCT SPECIFICATIONS AND DATA ARE SUBJECT TO CHANGE WITHOUT NOTICE TO IMPROVE RELIABILITY, FUNCTION OR DESIGN OR OTHERWISE.

Vishay Intertechnology, Inc., its affiliates, agents, and employees, and all persons acting on its or their behalf (collectively, "Vishay"), disclaim any and all liability for any errors, inaccuracies or incompleteness contained in any datasheet or in any other disclosure relating to any product.

Vishay makes no warranty, representation or guarantee regarding the suitability of the products for any particular purpose or the continuing production of any product. To the maximum extent permitted by applicable law, Vishay disclaims (i) any and all liability arising out of the application or use of any product, (ii) any and all liability, including without limitation special, consequential or incidental damages, and (iii) any and all implied warranties, including warranties of fitness for particular purpose, non-infringement and merchantability.

Statements regarding the suitability of products for certain types of applications are based on Vishay's knowledge of typical requirements that are often placed on Vishay products in generic applications. Such statements are not binding statements about the suitability of products for a particular application. It is the customer's responsibility to validate that a particular product with the properties described in the product specification is suitable for use in a particular application. Parameters provided in datasheets and/or specifications may vary in different applications and performance may vary over time. All operating parameters, including typical parameters, must be validated for each customer application by the customer's technical experts. Product specifications do not expand or otherwise modify Vishay's terms and conditions of purchase, including but not limited to the warranty expressed therein.

Except as expressly indicated in writing, Vishay products are not designed for use in medical, life-saving, or life-sustaining applications or for any other application in which the failure of the Vishay product could result in personal injury or death. Customers using or selling Vishay products not expressly indicated for use in such applications do so at their own risk. Please contact authorized Vishay personnel to obtain written terms and conditions regarding products designed for such applications.

No license, express or implied, by estoppel or otherwise, to any intellectual property rights is granted by this document or by any conduct of Vishay. Product names and markings noted herein may be trademarks of their respective owners.

## Material Category Policy

**Vishay Intertechnology, Inc. hereby certifies that all its products that are identified as RoHS-Compliant fulfill the definitions and restrictions defined under Directive 2011/65/EU of The European Parliament and of the Council of June 8, 2011 on the restriction of the use of certain hazardous substances in electrical and electronic equipment (EEE) - recast, unless otherwise specified as non-compliant.**

**Please note that some Vishay documentation may still make reference to RoHS Directive 2002/95/EC. We confirm that all the products identified as being compliant to Directive 2002/95/EC conform to Directive 2011/65/EU.**

**Vishay Intertechnology, Inc. hereby certifies that all its products that are identified as Halogen-Free follow Halogen-Free requirements as per JEDEC JS709A standards. Please note that some Vishay documentation may still make reference to the IEC 61249-2-21 definition. We confirm that all the products identified as being compliant to IEC 61249-2-21 conform to JEDEC JS709A standards.**



Компания «ЭлектроПласт» предлагает заключение долгосрочных отношений при поставках импортных электронных компонентов на взаимовыгодных условиях!

Наши преимущества:

- Оперативные поставки широкого спектра электронных компонентов отечественного и импортного производства напрямую от производителей и с крупнейших мировых складов;
- Поставка более 17-ти миллионов наименований электронных компонентов;
- Поставка сложных, дефицитных, либо снятых с производства позиций;
- Оперативные сроки поставки под заказ (от 5 рабочих дней);
- Экспресс доставка в любую точку России;
- Техническая поддержка проекта, помощь в подборе аналогов, поставка прототипов;
- Система менеджмента качества сертифицирована по Международному стандарту ISO 9001;
- Лицензия ФСБ на осуществление работ с использованием сведений, составляющих государственную тайну;
- Поставка специализированных компонентов (Xilinx, Altera, Analog Devices, Intersil, Interpoint, Microsemi, Aeroflex, Peregrine, Syfer, Eurofarad, Texas Instrument, Miteq, Cobham, E2V, MA-COM, Hittite, Mini-Circuits, General Dynamics и др.);

Помимо этого, одним из направлений компании «ЭлектроПласт» является направление «Источники питания». Мы предлагаем Вам помощь Конструкторского отдела:

- Подбор оптимального решения, техническое обоснование при выборе компонента;
- Подбор аналогов;
- Консультации по применению компонента;
- Поставка образцов и прототипов;
- Техническая поддержка проекта;
- Защита от снятия компонента с производства.



#### Как с нами связаться

**Телефон:** 8 (812) 309 58 32 (многоканальный)

**Факс:** 8 (812) 320-02-42

**Электронная почта:** [org@eplast1.ru](mailto:org@eplast1.ru)

**Адрес:** 198099, г. Санкт-Петербург, ул. Калинина, дом 2, корпус 4, литера А.