



## Overvoltage/Undervoltage Monitoring Relay for AC and DC Input

- Detect overvoltages or undervoltages (switch selectable) from 4 mV to 300 V.
- Detect undercurrent, reverse current, or overcurrent in DC circuits using shunt (SDV-FL).
- Detect three-phase AC current for under and/or overcurrent using current converter.
- Available in 7 supply voltage configurations.
- Single-function model with ON-delay, OFF-delay, or start-up lock settings (SDV-FH□T).
- Select either AC or DC voltage input.
- Polarity can be specified (SDV-FL) to enable easy reverse current detection.
- Selectable reset value range from 2% to 30% of operating value (SDV-F).
- LED operation indicator.
- UL/CSA approval (single-function models).



## Model Number Structure

### ■ Model Number Legend

SDV-□□□□□□  
1 2 3 4 5 6

#### 1. Voltage Sensor

#### 2. Operation

- F: Single-function (overvoltage or undervoltage detection)
- D: Dual-function (overvoltage and undervoltage detection)

#### 3. Operating Voltage Range

- L: 4 to 240 mV (DC input only) (For SDV-F only)
- M: 0.2 to 12 V (AC or DC input)
- H: 10 to 300 V (AC or DC input)

#### 4, 5. Control Power Supply Voltage

- 2: 24 VDC
- 3: 48 VDC
- 4: 100/110 VDC
- 5: 125 VDC
- 51: 200/220 VDC (Single-function models)
- 6: 100/110 VAC
- 61: 120 VAC (Single-function models)
- 7: 200/220 VAC
- 71: 240 VAC (Single-function models)

#### 6. Timing Function (SDV-FH Only (See Note))

- None: Not provided
- T: Provided

**Note:** SDV-FL and SDV-FM models can also be equipped with the timing function as a special specification. Ask your OMRON representative for details.

**Note:** Not possible for the SDV equipped with the timing function (SDV-FH□T).

**SDV-SH □□□□ (Order Separately)**

1      2 3 4 5

1. Shunt (For SDV-FL Only)

2, 3, 4, 5. Rated Current

**Available Models**

Rated current	Rated voltage	Model	Rated current	Rated voltage	Model
5 A	60 mV	SDV-SH5	75 A	60 mV	SDV-SH75
7.5 A		SDV-SH7.5	100 A		SDV-SH100
7.5 A	100 mV	SDV-SH7.5 100MV	150 A		SDV-SH150
10 A	60 mV	SDV-SH10	200 A		SDV-SH200
15 A		SDV-SH15	300 A		SDV-SH300
20 A		SDV-SH20	500 A		SDV-SH500
30 A		SDV-SH30	750 A		SDV-SH750
50 A		SDV-SH50	1,000 A		SDV-SH1000

**Note:** All the above listed shunts have an accuracy in the 1.0 class.**Connecting Socket (Order Separately)**

Applicable models	Socket	
	Type	Model
SDV-F□□/-FH□T	Front Connecting Socket	8PFA1
	Back Connecting Socket	PL08
SDV-D□□	Front Connecting Socket	14PFA
	Back Connecting Socket	PL15

**Ordering Information****Single-function Models****Overvoltage or Undervoltage Detection (Switch Selectable)**

Control power supply voltage	Input		
	DC	DC or AC (selectable)	
	Input voltage range		
	4 to 240 mV	0.2 to 12 V	10 to 300 V
24 VDC	SDV-FL2	SDV-FM2	SDV-FH2
48 VDC	SDV-FL3	SDV-FM3	SDV-FH3
100/110 VDC	SDV-FL4	SDV-FM4	SDV-FH4
125 VDC	SDV-FL5	SDV-FM5	SDV-FH5
200/220 VDC	---	---	SDV-FH51
100/110 VAC	SDV-FL6	SDV-FM6	SDV-FH6
120 VAC	---	---	SDV-FH61
200/220 VAC	SDV-FL7	SDV-FM7	SDV-FH7
240 VAC	---	---	SDV-FH71

**Dual-function Models****Overvoltage and Undervoltage Detection**

Control power supply voltage	Input: DC or AC (selectable)	
	Input voltage range	
	0.2 to 12 V	10 to 300 V
24 VDC	SDV-DM2	SDV-DH2
48 VDC	SDV-DM3	SDV-DH3
100/110 VDC	SDV-DM4	SDV-DH4
125 VDC	SDV-DM5	SDV-DH5
100/110 VAC	SDV-DM6	SDV-DH6
200/220 VAC	SDV-DM7	SDV-DH7
240 VAC	SDV-DM71	SDV-DH71

- Note:**
- Inquire about production of models with 120- and 240-VAC control power supply.
  - Inquire about models with special processing for high-temperature, high-humidity applications.
  - The ripple factor must be 5% or less for DC power supplies.

## Single-function Models with Timing Function

Control power supply voltage	Input: DC or AC (selectable); input voltage range: 10 to 300 V		
	Operating mode		
	ON-delay	OFF-delay	Startup lock
24 VDC	SDV-FH2T		
48 VDC	SDV-FH3T		
100/110 VDC	SDV-FH4T		
125 VDC	SDV-FH5T		
200/220 VDC	SDV-FH51T		
100/110 VAC	SDV-FH6T		
120 VAC	SDV-FH61T		
200/220 VAC	SDV-FH7T		
240 VAC	SDV-FH71T		

**Note:** SDV-FL and SDV-FM models can also be equipped with the timing function as a special specification. Ask your OMRON representative for details.

## Specifications

### Single-function Models

#### Overvoltage or Undervoltage Detection (Switch Selectable)

Model	Input voltage	Selectable operating range	Selectable reset value range	Control power supply
SDV-FL□	DC	4 to 240 mV (4 to 12 mV, 10 to 30 mV, 20 to 60 mV, 40 to 120 mV, 80 to 240 mV)	2% to 30% (related to operating value)	24, 48, 100/110, 125, 200/220 VDC (see note); 100/110, 200/220/240 VAC (50/60 Hz)
SDV-FM□	DC or AC (selectable)	0.2 to 12 V (0.2 to 0.6 V, 0.5 to 1.5 V, 1 to 3 V, 2 to 6 V, 4 to 12 V)		
SDV-FH□ SDV-FH□T		10 to 300 V (10 to 30 V, 25 to 75 V, 50 to 150 V, 100 to 300 V)		

**Note:** Ripple is 5% max. with DC power supplies.

### Dual-function Models

#### Overvoltage and Undervoltage Detection

Model	Input voltage	Selectable operating range		Reset value	Control power supply
		Intermediate voltage of dead band	Dead band voltage		
SDV-DM□	DC or AC (selectable)	0.2 to 12 V	0.2 to 0.6 V	0.02 to 0.1 V	Overvoltage: (Intermediate voltage of dead band + dead band voltage) – (dead band volt- age x 2/3) min.  Undervoltage: (Intermediate voltage of dead band – dead band voltage) + (dead band volt- age x 2/3) max.
			0.5 to 1.5 V	0.05 to 0.25 V	
			1 to 3 V	0.1 to 0.5 V	
			2 to 6 V	0.2 to 1 V	
			4 to 12 V	0.4 to 2 V	
SDV-DH□		10 to 300 V	10 to 30 V	1 to 5 V	
			25 to 75 V	2.5 to 12.5 V	
			50 to 150 V	5 to 25 V	
			100 to 300 V	10 to 50 V	

**Note:** 1. Inquire about production of models with 120- and 240-VAC control power supply.  
2. The ripple factor must be 5% or less for DC power supplies.

## ■ Ratings

Item	SDV-FL□	SDV-FM□	SDV-FH□/FH□T	SDV-DM□	SDV-DH□
Allowable continuous input overvoltage range	±10 VDC	±150 VDC 150 VAC	±350 VDC (±500 VDC for 1 min) 350 VAC (500 VAC for 1 min)	±150 VDC 150 VAC	±350 VDC (±500 VDC for 1 min) 350 VAC (500 VAC for 1 min)
Input impedance	1 kΩ	50 kΩ	2,500 kΩ	50 kΩ	2,500 kΩ
Control output	SPDT			SPST-NO and SPST-NC	
	Rated load: 5 A at 220 VAC ( $\cos\phi = 1$ ), 5 A at 24 VDC ( $\cos\phi = 1$ ), 2 A at 220 VAC ( $\cos\phi = 0.4$ ), 2 A at 24 VDC (L/R = 7 ms) Max. contact voltage: 250 VAC, 125 VDC Max. contact current: 5 A Max. switching capacity: 1,100 VA ( $\cos\phi = 1$ ), 120 W ( $\cos\phi = 1$ ), 440 VA ( $\cos\phi = 0.4$ ), 48 W (L/R = 7 ms)				
Power consumption	DC: 5 W max.; AC: 5 VA max.				
Ambient temperature	-10 to 55°C (with no icing)				
Control supply voltage (see note)	24, 48, 100/110, 125, 200/220 VDC; DC operating voltage range: 80% to 130% of control power supply 100/110/120, 200/220/240 VAC (50/60 Hz); AC operating voltage range: 85% to 110% of control power supply				

Note: The impedance value is a reference value; actual values may vary.

## ■ Characteristics

Item	SDV-F□□	SDV-FH□T	SDV-D□□
Operating value	100% operation for voltage setting		
Setting error	Operating value: ±2% of operating value (This is the ratio for the setting value.) Reset value: ±7% of reset value (This is the ratio for the setting value.)		±2% of intermediate voltage of dead band, ±1% of dead band voltage
Operating time	0.5 s max. (see note)		
Influence of temperature	0 to 40°C: ±2% max. of operating value (SDV-FL (operating value range: 4 to 12 mV) ±4% max. of operating value) -10 to 0°C, 40 to 55°C: ±4% max. of operating value (SDV-FL (operating value range: 4 to 12 mV) ±8% max. of operating value)		0 to 40°C: ±2% max. of dead band voltage -10 to 0°C, 40 to 55°C: ±4% max. of dead band voltage
Influence of control power	±1% max. of operating value DC operating voltage range: 80% to 130% AC operating voltage range: 85% to 110%		±1% max. of dead band voltage DC operating voltage range: 80% to 130% AC operating voltage range: 85% to 110%
Influence of frequency (Input frequency changed from 10 to 500 Hz for AC input)	±1% max. of operating value		±1% max. of dead band voltage
Influence of waveform (For commercial frequency, single-phase, full-wave AC input)	±3% max. of operating value		±3% max. of dead band voltage
Insulation resistance	10 MΩ min. (at 500 VDC) between the entire electric circuitry and external case, and between the input terminal and power terminal		
Dielectric strength	2,000 VAC for 1 min between the entire electric circuitry and external case, and between the input terminal and power terminal		
Impulse withstand voltage	±1.2 x 50 μs, 4,500 V between the entire electric circuitry and external case ±1.2 x 50 μs, 3,000 V between power terminals		
Vibration resistance	Destruction: 10 to 25 Hz, 2-mm double amplitude (2G max.) for 2 hrs each in 3 directions Malfunction: 16.7 Hz, 1-mm double amplitude for 10 min each in 3 directions		
Shock resistance	Destruction: 294 m/s <sup>2</sup> (30G) Malfunction: 98 m/s <sup>2</sup> (10G)		
Weight	Approx. 290 g	Approx. 350 g	Approx. 310 g

Note: Overvoltage: Operation when voltage is changed from 80% to 120% of the operating value.  
Undervoltage: Operation when voltage is changed from 120% to 80% of the operating value.

## Timing Function

Item	SDV-FH□T
Setting time	0.5 to 30.0 s (see note)
Operating time accuracy	±5% FS max.
Setting error	±15% FS max.
Reset time	5 s min.
Influence of temperature	±10% FS max.
Operating mode (set via DIP switch)	ON-delay, OFF-delay, Startup lock

**Note:** The time setting range when the startup lock is selected for the operating mode is approximately 1 to 30 s.

## Nomenclature



# Operation

## ■ Timing Charts

### Single-function Models

#### Overvoltage Detection



#### Undervoltage Detection



### Note

The reset time must be 5 s or longer to ensure accuracy of the timing operation.

### Single-function Model with Timing Function

SDV-FH□T

#### ON-delay Overvoltage Detection



#### ON-delay Undervoltage Detection

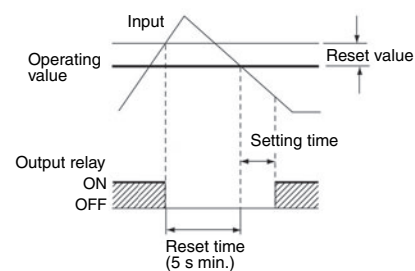

**OFF-delay Overvoltage Detection**



**OFF-delay Undervoltage Detection**



**Startup Lock**



**Note:** The output relays will be forced OFF from the control power supply is turned ON until the set time has expired.

**Dual-function Models  
SDV-D**

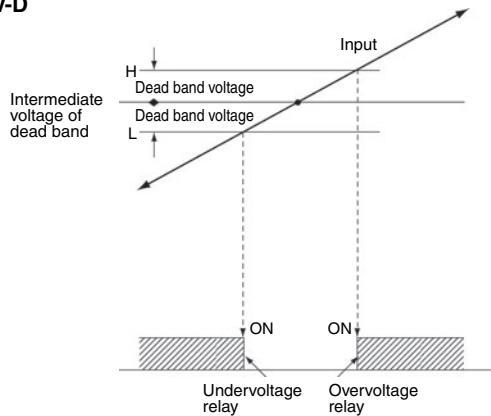

## ■ Setting

(Refer to *Examples of Mode Settings* for details on individual models.)

Set the desired values using the DIP switch and setting knobs on the front panel.

### Opening the DIP Switch Cover

Remove the cover of the compartment containing the DIP switch for various mode settings, and then set the DIP switch according to the SWITCH SELECTION table affixed to the side of the voltage sensor.



### Setting the DIP Switch

Set the DIP switch on the front panel for the required functions, operation inputs, and voltages. Set the switch to the top for ON settings and to the bottom for OFF settings.

- Function (SDV-F): Set to either overvoltage or undervoltage detection.
- Input: Set to either AC or DC input.
- Polarity (SDV-FL□ only): Set polarity or not to specify polarity.  
 “8(+), 7(-)”: Use polarity as shown for pin number.  
 “FREE”: Do not use polarity.
- Multiplying Factor: Set the voltage scale multiplying factor for the required operating voltage setting range.
- TIMER (SDV-FH□T): Select the timing function.  
 Set ON-delay, OFF-delay, lock timer (start lock timer), or TIMER OFF.  
 If TIMER OFF is set, the timing function will not be effective, and the single-function operation will be performed.

### Setting of Time (SDV-FH□T Only)

Use the time setting knob to set the desired time.

### Closing the DIP Switch Cover

Attach the cover to the compartment housing the DIP switch. Select the stickers for the settings that have been made and attach them to the cover.

### Setting Flowchart

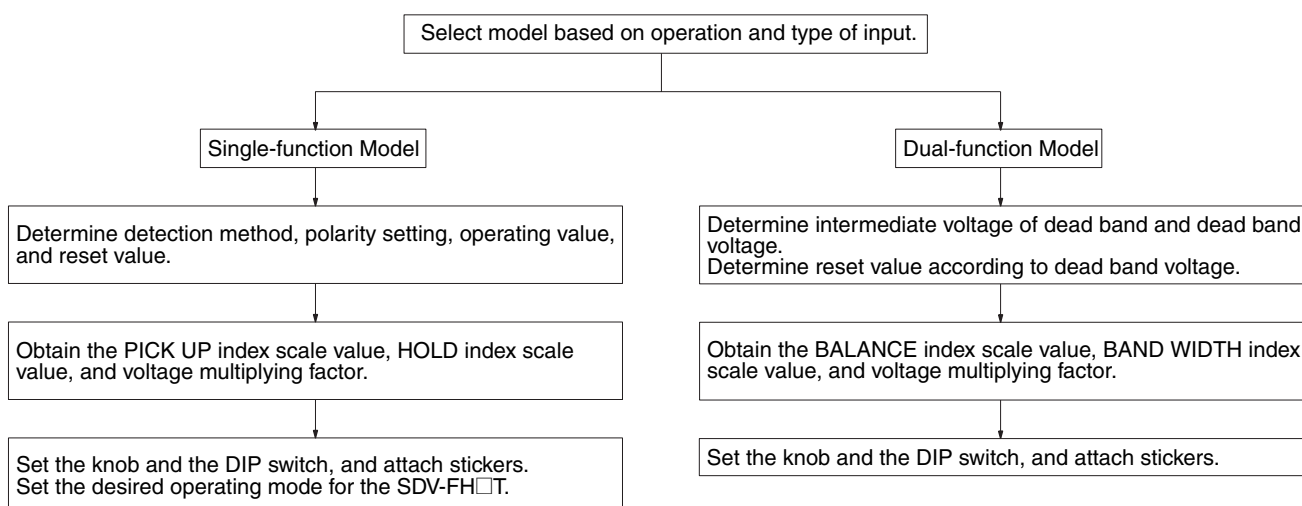



**SDV-FL**

**Switch Selection Table**

Switch	ON ●↑	1	2	3	4	5	6
	OFF ○↓	■	■	■	■	■	■
Function	Under	●					
	Over	○					
Polarity	8 (+) 7 (-)		●				
	Free		○				
Multiplying factor	x 4 mV	→		○	○	○	○
	x 10 mV	→		●	○	○	○
	x 20 mV	→		○	●	○	○
	x 40 mV	→		○	○	●	○
	x 80 mV	→		○	○	○	●

**Accessory Labels**

OVER POL. FREE	x4 mV
OVER 8 (+) POL. 7 (-)	x10 mV
UNDER POL. FREE	x20 mV
UNDER 8 (+) POL. 7 (-)	x40 mV
	x80 mV

**SDV-FM**

**Switch Selection Table**

Switch	ON ●↑	1	2	3	4	5	6
	OFF ○↓	■	■	■	■	■	■
Function	Under	●					
	Over	○					
Input	AC (20 to 500 Hz)		●				
	DC		○				
Multiplying factor	x 0.2 V	→		○	○	○	○
	x 0.5 V	→		●	○	○	○
	x 1 V	→		○	●	○	○
	x 2 V	→		○	○	●	○
	x 4 V	→		○	○	○	●

**Accessory Labels**

OVER INPUT DC	x0.2 V
OVER INPUT AC	x0.5 V
UNDER INPUT DC	x1 V
UNDER INPUT AC	x2 V
	x4 V

**SDV-FH**

**Switch Selection Table**

Switch	ON ●↑	1	2	3	4	5	6
	OFF ○↓	■	■	■	■	■	■
Function	Under	●					NO USE (see note)
	Over	○					
Input	AC (20 to 500 Hz)		●				
	DC		○				
Multiplying factor	x 10 V	→		○	○	○	
	x 25 V	→		●	○	○	
	x 50 V	→		○	●	○	
	x 100 V	→		○	○	●	

**Accessory Labels**

OVER INPUT DC	x10 V
OVER INPUT AC	x25 V
UNDER INPUT DC	x50 V
UNDER INPUT AC	x100 V

**Note:** "NO USE" indicates that DIP switch setting is not required and the positions of these switches are irrelevant to the operation of the voltage sensor.

## SDV-FH□T

## Switch Selection Table

Switch	ON ●↑	1	2	3	4	5	6	7	8	9	10	
	OFF ○↓	<input checked="" type="checkbox"/>	<input checked="" type="checkbox"/>	<input checked="" type="checkbox"/>	<input checked="" type="checkbox"/>	<input checked="" type="checkbox"/>	<input checked="" type="checkbox"/>	<input checked="" type="checkbox"/>	<input checked="" type="checkbox"/>	<input checked="" type="checkbox"/>	<input checked="" type="checkbox"/>	
Function	Under	●					NO USE (see note)				NO USE (see note)	
	Over	○										
Input	AC (20 to 500 Hz)	●										
	DC	○										
Multiplying factor	x 10 V	→		○	○	○						
	x 25 V	→		●	○	○						
	x 50 V	→		○	●	○						
	x 100 V	→		○	○	●						
Timer	ON-delay							→	●	●		●
	OFF-delay							→	●	●		○
	Lock timer						→	○	○	●		
	Timer OFF						→	○	○	○		

## Accessory Labels

OVER INPUT DC	x10 V
OVER INPUT AC	x25 V
UNDER INPUT DC	x50 V
UNDER INPUT AC	x100 V

Note: "NO USE" indicates that DIP switch setting is not required and the positions of these switches are irrelevant to the operation of the voltage sensor.

## SDV-DM□

## Switch Selection Table

Switch	ON ●↑	1	2	3	4	5
	OFF ○↓	<input checked="" type="checkbox"/>	<input checked="" type="checkbox"/>	<input checked="" type="checkbox"/>	<input checked="" type="checkbox"/>	<input checked="" type="checkbox"/>
Input	AC (20 to 500 Hz)	●				
	DC	○				
Multiplying factor	x 0.2 V	→	○	○	○	○
	x 0.5 V	→	●	○	○	○
	x 1 V	→	○	●	○	○
	x 2 V	→	○	○	●	○
	x 4 V	→	○	○	○	●

## Accessory Labels

OVER & UNDER INPUT DC	x0.2 V
OVER & UNDER INPUT AC	x0.5 V
	x1 V
	x2 V
	x4 V

## SDV-DH□

## Switch Selection Table

Switch	ON ●↑	1	2	3	4	5
	OFF ○↓	<input checked="" type="checkbox"/>	<input checked="" type="checkbox"/>	<input checked="" type="checkbox"/>	<input checked="" type="checkbox"/>	<input checked="" type="checkbox"/>
Input	AC (20 to 500 Hz)	●				
	DC	○				
Multiplying factor	x 10 V	→	○	○	○	NO USE (see note)
	x 25 V	→	●	○	○	
	x 50 V	→	○	●	○	
	x 100 V	→	○	○	●	

## Accessory Labels

OVER & UNDER INPUT DC	x10 V
OVER & UNDER INPUT AC	x25 V
	x50 V
	x100 V

Note: "NO USE" indicates that DIP switch setting is not required and the positions of these switches are irrelevant to the operation of the voltage sensor.

## Examples of Mode Setting

### Example 1

For the single-function SDV-FH6, the setting method given below would be used to detect overvoltages with a DC voltage input. The operating value is 15 V and the reset value is 12 V.

**Step 1.** To set the detection method and type of input on the DIP switch.

- Turn OFF pin 1 (function) to specify overvoltage detection.
- Turn OFF pin 2 (input) to specify a DC input.
- Attach the OVER INPUT DC stickers.

**Step 2.** To set the operating value according to the voltage multiplying factor and the PICK UP index scale value.

Voltage multiplying factor setting: The voltage multiplying factor is selected according to the maximum and minimum factors and a sticker is attached. The calculation method is as follows:

The PICK UP index scale value is between 1.0 and 3.0, so calculate the voltage multiplying factor for both 1.0 and 3.0.

15 V (Operating value)/1 (PICK UP index scale value) = 15 (Maximum multiplying factor)

15 V (Operating value)/3 (PICK UP index scale value) = 5 (Minimum multiplying factor)

In this example, pins 3 to 5 are turned OFF and the x10V sticker is attached.

PICK UP index scale value setting: The calculation method is as follows (X = index scale):

10 (Voltage multiplying factor) x X = 15 V (Operating value)

Therefore, X = 1.5

Turn the PICK UP knob to 1.5.

**Step 3.** To set the reset value (Y = HOLD index scale value): Calculate the HOLD percentage as follows:

12 V (reset value) = 15 V (operating value) x (1 - Y) Therefore, Y = 0.2

Set the HOLD knob to 20 (%).

SDV-F□□



### Example 2

For the single-function SDV-FH6T, the setting method given below would be used to detect undervoltages with a DC voltage input. The operating value is 20 V and the reset value is 20.4 V. An ON-delay operation is specified and the setting time is 30 s.

**Step 1.** To set the detection method and type of input on the DIP switch.

- Turn ON pin 1 (function) to specify undervoltage detection.
- Turn OFF pin 2 (input) to specify a DC input.
- Attach the UNDER INPUT DC stickers.

**Step 2.** To set the operating value according to the voltage multiplying factor and the PICK UP index scale value.

Voltage multiplying factor setting: The multiplying factor is selected according to the maximum and minimum factors and a sticker is attached. The calculation method is as follows:

The PICK UP index scale value is between 1.0 and 3.0, so calculate the voltage multiplying factor for both 1.0 and 3.0.

20 V (Operating value)/1 (PICK UP index scale value) = 20 (Maximum multiplying factor)

20 V (Operating value)/3 (PICK UP index scale value) = 6.7 (Minimum multiplying factor)

In this example, pins 3 to 5 are turned OFF and the x10V sticker is attached.

PICK UP index scale value setting: The calculation method is as follows (X = index scale):

10 (Voltage multiplying factor) x X = 20 V (Operating value)

Therefore, X = 2

Turn the PICK UP knob to 2.0.

**Step 3.** To set the reset value (Y = HOLD index scale value): Calculate the HOLD percentage as follows:

20.4 V (reset value) = 20 V (operating value) x (1 + Y) Therefore, Y = 0.02

Set the HOLD knob to 2 (%).

**Step 4.** To set setting time and operating mode.

Set the time setting knob to 30 s and turn the pins 7 to 9 ON to specify ON-delay operation.

SDV-FH□T



### Example 3

For the dual-function SDV-DH3, the setting method given below would be used to detect over and undervoltage with an AC voltage input. The intermediate voltage of dead band is 250 V and the dead band voltage is 20 V.

**Step 1.** To set the detection method and type of input on the DIP switch.

- Turn ON pin 1 (input) to specify a AC input.
- Attach the OVER and UNDER INPUT AC stickers.

**Step 2.** To set the intermediate voltage of dead band according to the BALANCE index scale value and the voltage multiplying factor.

**Voltage multiplying factor setting:** The voltage multiplying factor is selected according to the maximum and minimum factors and a sticker is attached. The calculation method is as follows:

The BALANCE index scale value is between 1.0 and 3.0, so calculate the voltage multiplying factor for both 1.0 and 3.0.

$$250 \text{ V (Intermediate voltage of dead band)} / 1 \text{ (BALANCE index scale value)} = 250 \text{ (maximum multiplying factor)}$$

$$250 \text{ V (Intermediate voltage of dead band)} / 3 \text{ (BALANCE index scale value)} = 83.3 \text{ (maximum multiplying factor)}$$

In this example, pins 2 and 3 are turned OFF and pins 4 is turned ON, and the x100V sticker is attached.

**BALANCE index scale value setting:** The calculation method is as follows for the BALANCE index scale value (X = index scale):

$$100 \text{ (Voltage multiplying factor)} \times X = 250 \text{ V (intermediate voltage of dead band)}$$

$$\text{Therefore, } X = 2.5$$

Turn the BALANCE knob to 2.5.

**Step 3.** To set dead band voltage according to the voltage multiplying factor and BAND WIDTH index scale value.

**BAND WIDTH index scale value setting:**

$$Z \text{ (BAND WIDTH index scale value)} \times 100 \text{ V (voltage multiplying factor)} = 20 \text{ V (dead band voltage)}$$

Therefore, Z = 0.2

Set the DEAD WIDTH knob to 0.2.

**Step 4.** Reset value for each detection setting: Automatically set according to the dead band voltage setting.

Reset values are calculated for overvoltage detection and undervoltage detection.

$$\text{Overvoltage detection: Reset value} = (250 \text{ V} + 20 \text{ V}) - (20 \text{ V} \times 2/3) = 256.7 \text{ min.}$$

$$\text{Undervoltage detection: Reset value} = (250 \text{ V} - 20 \text{ V}) + (20 \text{ V} \times 2/3) = 243.3 \text{ max.}$$

SDV-D□□



### ■ Shunts (Order Separately)

A shunt is a resistor to convert a DC current into a DC voltage. Use the shunt in combination with SDV-FL to detect undercurrent, reverse current and overcurrent in DC circuits.

**Note:** Select a shunt whose rated current is more than 120% of the current normally flowing in a circuit. The characteristics of the shunt may change or fusing of a resistor element may occur if an overload that is 1,000% of the rated current is applied. Therefore, determine the rated current of the shunt to be used, by taking the circuit conditions into account.

**Characteristics**  
SDV-SH5A (Rated Current: 5 A)



## Application Example

### Current Detection Using the Shunt (SDV-FL)

#### Overload Detection (A)



**Example:** Overload detection in a distribution switch board installed in a power substation.

#### Overload Detection (B)



**Example:** Overload detection in equipment such as a motor in a rolling mill when the polarity of the applied voltage to the motor is reversed.

#### Reverse Current Detection (A)



**Example:** Detection when a DC motor is used as a generator (or a generator is used as a motor).

#### Reverse Current Detection (B)



**Example:** Detection of an output current from a transmitter on a control panel.

### Voltage Detection (SDV-FM/FH/FH□T/-DM/-DH)

#### Voltage Regulation



**Example:** Voltage regulation of a power supply unit in the distribution switchboard installed in a power substation.

#### Operation Lock Due to Voltage Drop (Alarm)



**Example:** Function lock due to voltage drop in a machine or equipment (alarm).

Emergency Power Supply (e.g. Standard Power Receiving/Distributing Facility)



### Three-phase AC Current Detection Using Current Converter



**Example:** Machine motor control, overload detection, undercurrent detection.

### Current Converters (Order Separately)

Model	Current range
SET-3A	1 to 80 A
SET-3B	64 to 160 A

### Three-phase AC Current Detection with Startup Lock Operation (When Using Same Power Supply for Motor and Control Power Supply)



### Voltage Monitoring in Rectifiers (Chargers) with ON-delay Operation

**Example:** To detect only overvoltage and not detect voltages for instantaneous load changes (ON/OFF).



**Note:** Detection of excessive or insufficient charge in rectifiers (chargers).

## ■ Q&A

**Q:** What is necessary to detect undervoltages when using the same power supply for the input voltage and the control power supply?



SDV-F (undervoltage detection)

**A:** The NO contact of the output relay is used for undervoltage detection. Even if the control voltage drops to 85% of the rated voltage (AC power), the operation of the relay can be maintained. Set the mode setting on the DIP switch to overvoltage detection and set the reset value to the value to be detected. Set the operating value of the SDV to a value higher than the reset value.

**Q:** Will the SDV be damaged if the input setting (AC/DC) is incorrect. If not, what will happen?

**A:** The SDV will not be damaged, but the operating value and reset value will not be accurate. These values will be about 10% less than the set values if DC is input for an AC setting and about 10% off to the positive side if AC is input for a DC setting.

**Q:** Can the negative pole of a DC voltage be input to the SDV?

**A:** Yes. An absolute rectifier circuit is used in the SDV-F to enable negative pole input. The SDV-FL has a polarity setting, which can be set to (+)(-) to disable operation with negative voltages. Positive/Negative settings cannot be used for the dual-function SDV-D even if the intermediate voltage of dead band is set to 0. Negative inputs cannot be used for the SDV-D.

**Q:** Is instantaneous detection faster than 0.5 s possible?

**A:** Use the S87A Power Interruption Detector for instantaneous detection (10 ms or 20 ms).



# Dimensions

Note: All units are in millimeters unless otherwise indicated.

## Main Body

SDV-F□□/SDV-FH□T



### Connecting Socket



SDV-D□□



## Shunts

SDV-SH5 to SDV-SH50 (60-mV Rating)



Current terminal: M6 screw  
Voltage terminal: M4 screw

SDV-SH75 to SDV-SH200 (60-mV Rating)



Current terminal: M8 screw  
Voltage terminal: M4 screw

Model	A	B	C	D	E	F	G
SDV-SH75	140	120	25	10.5	6	18	36
SDV-SH100	140	120	25	10.5	6	18	36
SDV-SH150	140	120	25	10.5	6	18	43
SDV-SH200	140	120	25	10.5	6	18	43

## SDV-SH300/-SH500 (60-mV Rating)



Current terminal: M10 screw (SDV-SH300),  
M12 screw (SDV-SH500)  
Voltage terminal: M4 screw

Model	A	B	C	D	E	Resistor
SDV-SH300	130	30	110	4	36	4
SDV-SH500	160	40	120	6	41	5

**Note:** Inquire about models with a rated current of 1,500 A or larger.

## SDV-SH750/-SH1000 (60-mV Rating)

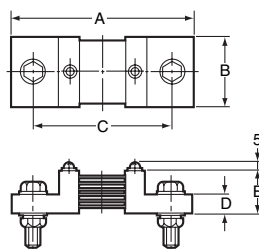

Current terminal: M12 screw  
Voltage terminal: M5 screw

Model	A	B	C	D	E
SDV-SH750	175	45	130	15	30
SDV-SH1000	175	60	135	18	30

## Accessories (Order Separately)

### Front Connecting Socket

#### 8PFA1



#### Terminal Arrangement (Top View)



#### Mounting Holes

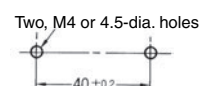

#### 14PFA



#### Terminal Arrangement (Top View)

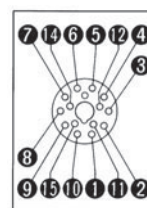

#### Mounting Holes



## Back Connecting Socket (Solder Terminal)

### PL08



### PL15



## Mounting Track

PFP-100N  
PFP-50N



PFP-100N2

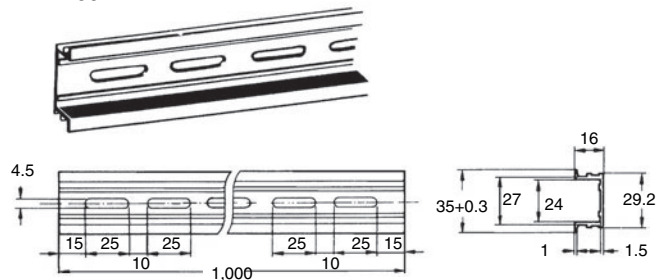

## End Plates

PFP-M

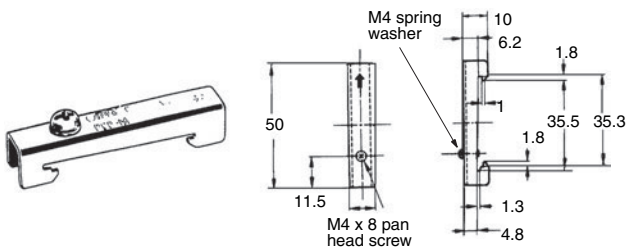

## Spacers

PFP-S

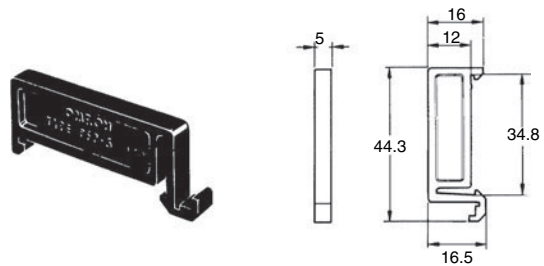

# Installation

## Internal Circuit

Input and power supply circuits are electrically isolated as protection against mutual interference.

### SDV-F□□/SDV-FH□□



- Note:**
1. There is no polarity setting for the SDV-FM or SDV-FH/FH□□.
  2. There is no power supply polarity setting when using a DC control power supply for the SDV.
  3. The polarity selection switch (SW2) is on the SDV-FL.
  4. The AC/DC switch (SW2) is on the SDV-FM and SDV-FH/FH□□.

### SDV-D

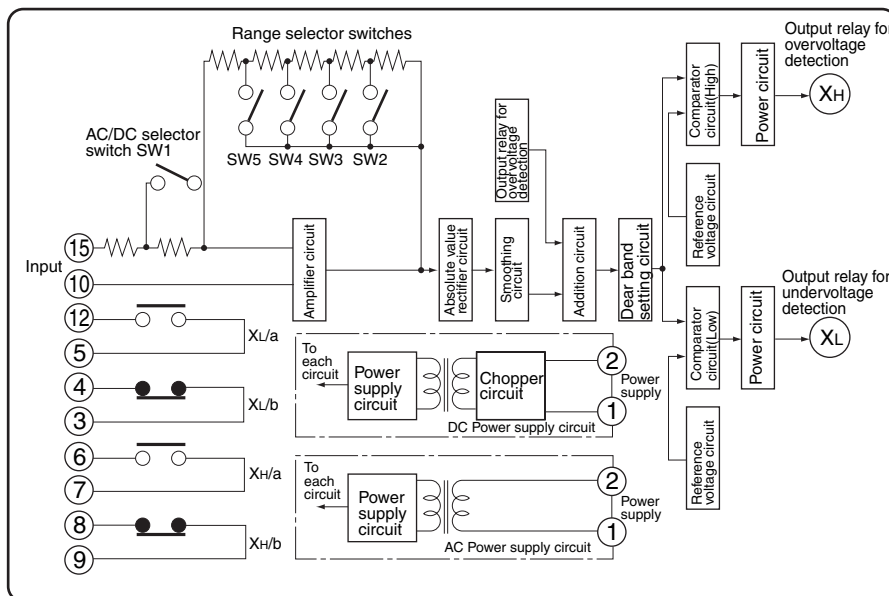

- Note:**
1. There is no power supply polarity setting when using a DC control power supply for the SDV.
  2. There is no polarity setting for DC inputs.

## Safety Precautions

Approximately 0.5 s is required for operation. When confirming the operating value, gradually change the input voltage while checking the value.

Power supply voltage fluctuations and the ambient operating temperature must be maintained within the allowable ranges. Be particularly careful not to apply an overvoltage beyond the specified range for the voltage detection.

Do not use the SDV in locations subject to corrosive or explosive gases.

The SDV cannot be used to detect momentary power interruptions because of its response time. Use the S87A to detect momentary power interruptions.



S87A Power Interruption Detector

An SDV cannot be used with a circuit containing thyristors, or VVVF inverters, because these elements can change the output waveform to the point that the SDV will malfunction.

### Mounting

When mounting with the PL08 or PL15 Back Connection Socket, insert the Socket into a 1- to 4-mm panel from the back and secure it with screws. Do not mount the SDV until the Socket has been mounted firmly. Be sure that the key groove on the Socket is mounted on the bottom, and also secure the SDV to the panel with screws.

When mounting with the 8PFA or 14PFA Back Connection Socket, insert the SDV into the Socket and secure it with the hooks. Leave approximately 30 mm or more between Sockets to allow enough space for the hooks.

When mounting more than one SDV, allow at least 30 mm or more between them.

ALL DIMENSIONS SHOWN ARE IN MILLIMETERS.

To convert millimeters into inches, multiply by 0.03937. To convert grams into ounces, multiply by 0.03527.

In the interest of product improvement, specifications are subject to change without notice.

## Read and Understand This Catalog

Please read and understand this catalog before purchasing the products. Please consult your OMRON representative if you have any questions or comments.

## Warranty and Limitations of Liability

### WARRANTY

OMRON's exclusive warranty is that the products are free from defects in materials and workmanship for a period of one year (or other period if specified) from date of sale by OMRON.

OMRON MAKES NO WARRANTY OR REPRESENTATION, EXPRESS OR IMPLIED, REGARDING NON-INFRINGEMENT, MERCHANTABILITY, OR FITNESS FOR PARTICULAR PURPOSE OF THE PRODUCTS. ANY BUYER OR USER ACKNOWLEDGES THAT THE BUYER OR USER ALONE HAS DETERMINED THAT THE PRODUCTS WILL SUITABLY MEET THE REQUIREMENTS OF THEIR INTENDED USE. OMRON DISCLAIMS ALL OTHER WARRANTIES, EXPRESS OR IMPLIED.

### LIMITATIONS OF LIABILITY

OMRON SHALL NOT BE RESPONSIBLE FOR SPECIAL, INDIRECT, OR CONSEQUENTIAL DAMAGES, LOSS OF PROFITS OR COMMERCIAL LOSS IN ANY WAY CONNECTED WITH THE PRODUCTS, WHETHER SUCH CLAIM IS BASED ON CONTRACT, WARRANTY, NEGLIGENCE, OR STRICT LIABILITY.

In no event shall the responsibility of OMRON for any act exceed the individual price of the product on which liability is asserted.

IN NO EVENT SHALL OMRON BE RESPONSIBLE FOR WARRANTY, REPAIR, OR OTHER CLAIMS REGARDING THE PRODUCTS UNLESS OMRON'S ANALYSIS CONFIRMS THAT THE PRODUCTS WERE PROPERLY HANDLED, STORED, INSTALLED, AND MAINTAINED AND NOT SUBJECT TO CONTAMINATION, ABUSE, MISUSE, OR INAPPROPRIATE MODIFICATION OR REPAIR.

## Application Considerations

### SUITABILITY FOR USE

OMRON shall not be responsible for conformity with any standards, codes, or regulations that apply to the combination of products in the customer's application or use of the products.

At the customer's request, OMRON will provide applicable third party certification documents identifying ratings and limitations of use that apply to the products. This information by itself is not sufficient for a complete determination of the suitability of the products in combination with the end product, machine, system, or other application or use.

The following are some examples of applications for which particular attention must be given. This is not intended to be an exhaustive list of all possible uses of the products, nor is it intended to imply that the uses listed may be suitable for the products:

- Outdoor use, uses involving potential chemical contamination or electrical interference, or conditions or uses not described in this catalog.
- Nuclear energy control systems, combustion systems, railroad systems, aviation systems, medical equipment, amusement machines, vehicles, safety equipment, and installations subject to separate industry or government regulations.
- Systems, machines, and equipment that could present a risk to life or property.

Please know and observe all prohibitions of use applicable to the products.

NEVER USE THE PRODUCTS FOR AN APPLICATION INVOLVING SERIOUS RISK TO LIFE OR PROPERTY WITHOUT ENSURING THAT THE SYSTEM AS A WHOLE HAS BEEN DESIGNED TO ADDRESS THE RISKS, AND THAT THE OMRON PRODUCTS ARE PROPERLY RATED AND INSTALLED FOR THE INTENDED USE WITHIN THE OVERALL EQUIPMENT OR SYSTEM.

### PROGRAMMABLE PRODUCTS

OMRON shall not be responsible for the user's programming of a programmable product, or any consequence thereof.

## Disclaimers

### CHANGE IN SPECIFICATIONS

Product specifications and accessories may be changed at any time based on improvements and other reasons.

It is our practice to change model numbers when published ratings or features are changed, or when significant construction changes are made. However, some specifications of the products may be changed without any notice. When in doubt, special model numbers may be assigned to fix or establish key specifications for your application on your request. Please consult with your OMRON representative at any time to confirm actual specifications of purchased products.

### DIMENSIONS AND WEIGHTS

Dimensions and weights are nominal and are not to be used for manufacturing purposes, even when tolerances are shown.

### PERFORMANCE DATA

Performance data given in this catalog is provided as a guide for the user in determining suitability and does not constitute a warranty. It may represent the result of OMRON's test conditions, and the users must correlate it to actual application requirements. Actual performance is subject to the OMRON Warranty and Limitations of Liability.

### ERRORS AND OMISSIONS

The information in this document has been carefully checked and is believed to be accurate; however, no responsibility is assumed for clerical, typographical, or proofreading errors, or omissions.

2011.12

In the interest of product improvement, specifications are subject to change without notice.

**OMRON Corporation**  
Industrial Automation Company

<http://www.ia.omron.com/>

(c)Copyright OMRON Corporation 2011 All Right Reserved.



Компания «ЭлектроПласт» предлагает заключение долгосрочных отношений при поставках импортных электронных компонентов на взаимовыгодных условиях!

Наши преимущества:

- Оперативные поставки широкого спектра электронных компонентов отечественного и импортного производства напрямую от производителей и с крупнейших мировых складов;
- Поставка более 17-ти миллионов наименований электронных компонентов;
- Поставка сложных, дефицитных, либо снятых с производства позиций;
- Оперативные сроки поставки под заказ (от 5 рабочих дней);
- Экспресс доставка в любую точку России;
- Техническая поддержка проекта, помощь в подборе аналогов, поставка прототипов;
- Система менеджмента качества сертифицирована по Международному стандарту ISO 9001;
- Лицензия ФСБ на осуществление работ с использованием сведений, составляющих государственную тайну;
- Поставка специализированных компонентов (Xilinx, Altera, Analog Devices, Intersil, Interpoint, Microsemi, Aeroflex, Peregrine, Syfer, Eurofarad, Texas Instrument, Miteq, Cobham, E2V, MA-COM, Hittite, Mini-Circuits, General Dynamics и др.);

Помимо этого, одним из направлений компании «ЭлектроПласт» является направление «Источники питания». Мы предлагаем Вам помощь Конструкторского отдела:

- Подбор оптимального решения, техническое обоснование при выборе компонента;
- Подбор аналогов;
- Консультации по применению компонента;
- Поставка образцов и прототипов;
- Техническая поддержка проекта;
- Защита от снятия компонента с производства.



#### Как с нами связаться

**Телефон:** 8 (812) 309 58 32 (многоканальный)

**Факс:** 8 (812) 320-02-42

**Электронная почта:** [org@eplast1.ru](mailto:org@eplast1.ru)

**Адрес:** 198099, г. Санкт-Петербург, ул. Калинина, дом 2, корпус 4, литера А.