



Is Now Part of



**ON Semiconductor®**

To learn more about ON Semiconductor, please visit our website at  
[www.onsemi.com](http://www.onsemi.com)

Please note: As part of the Fairchild Semiconductor integration, some of the Fairchild orderable part numbers will need to change in order to meet ON Semiconductor's system requirements. Since the ON Semiconductor product management systems do not have the ability to manage part nomenclature that utilizes an underscore (\_), the underscore (\_) in the Fairchild part numbers will be changed to a dash (-). This document may contain device numbers with an underscore (\_). Please check the ON Semiconductor website to verify the updated device numbers. The most current and up-to-date ordering information can be found at [www.onsemi.com](http://www.onsemi.com). Please email any questions regarding the system integration to [Fairchild\\_questions@onsemi.com](mailto:Fairchild_questions@onsemi.com).

ON Semiconductor and the ON Semiconductor logo are trademarks of Semiconductor Components Industries, LLC dba ON Semiconductor or its subsidiaries in the United States and/or other countries. ON Semiconductor owns the rights to a number of patents, trademarks, copyrights, trade secrets, and other intellectual property. A listing of ON Semiconductor's product/patent coverage may be accessed at [www.onsemi.com/site/pdf/Patent-Marking.pdf](http://www.onsemi.com/site/pdf/Patent-Marking.pdf). ON Semiconductor reserves the right to make changes without further notice to any products herein. ON Semiconductor makes no warranty, representation or guarantee regarding the suitability of its products for any particular purpose, nor does ON Semiconductor assume any liability arising out of the application or use of any product or circuit, and specifically disclaims any and all liability, including without limitation special, consequential or incidental damages. Buyer is responsible for its products and applications using ON Semiconductor products, including compliance with all laws, regulations and safety requirements or standards, regardless of any support or applications information provided by ON Semiconductor. "Typical" parameters which may be provided in ON Semiconductor data sheets and/or specifications can and do vary in different applications and actual performance may vary over time. All operating parameters, including "Typicals" must be validated for each customer application by customer's technical experts. ON Semiconductor does not convey any license under its patent rights nor the rights of others. ON Semiconductor products are not designed, intended, or authorized for use as a critical component in life support systems or any FDA Class 3 medical devices or medical devices with a same or similar classification in a foreign jurisdiction or any devices intended for implantation in the human body. Should Buyer purchase or use ON Semiconductor products for any such unintended or unauthorized application, Buyer shall indemnify and hold ON Semiconductor and its officers, employees, subsidiaries, affiliates, and distributors harmless against all claims, costs, damages, and expenses, and reasonable attorney fees arising out of, directly or indirectly, any claim of personal injury or death associated with such unintended or unauthorized use, even if such claim alleges that ON Semiconductor was negligent regarding the design or manufacture of the part. ON Semiconductor is an Equal Opportunity/Affirmative Action Employer. This literature is subject to all applicable copyright laws and is not for resale in any manner.



August 2015

# FGH60T65SHD

## 650 V, 60 A Field Stop Trench IGBT

### Features

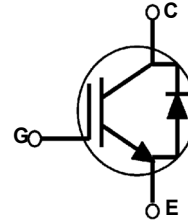
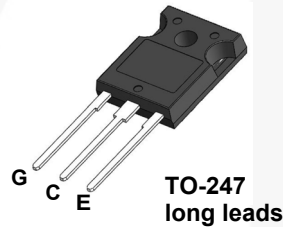
- Maximum Junction Temperature :  $T_J = 175^\circ\text{C}$
- Positive Temperature Co-efficient for Easy Parallel Operating
- High Current Capability
- Low Saturation Voltage:  $V_{CE(sat)} = 1.6\text{ V (Typ.) @ } I_C = 60\text{ A}$
- 100% of the Parts Tested for  $I_{LM}(1)$
- High Input Impedance
- Fast Switching
- Tighten Parameter Distribution
- RoHS Compliant

### General Description

Using novel field stop IGBT technology, Fairchild's new series of field stop 3<sup>rd</sup> generation IGBTs offer the optimum performance for solar inverter, UPS, welder, telecom, ESS and PFC applications where low conduction and switching losses are essential.

### Applications

- Solar Inverter, UPS, Welder, Telecom, ESS, PFC



### Absolute Maximum Ratings $T_C = 25^\circ\text{C}$ unless otherwise noted

Symbol	Description	FGH60T65SHD_F155	Unit
$V_{CES}$	Collector to Emitter Voltage	650	V
$V_{GES}$	Gate to Emitter Voltage	$\pm 20$	V
	Transient Gate to Emitter Voltage	$\pm 30$	V
$I_C$	Collector Current @ $T_C = 25^\circ\text{C}$	120	A
	Collector Current @ $T_C = 100^\circ\text{C}$	60	A
$I_{LM}(1)$	Pulsed Collector Current @ $T_C = 25^\circ\text{C}$	180	A
$I_{CM}(2)$	Pulsed Collector Current	180	A
$I_F$	Diode Forward Current @ $T_C = 25^\circ\text{C}$	60	A
	Diode Forward Current @ $T_C = 100^\circ\text{C}$	30	A
$I_{FM}(2)$	Pulsed Diode Maximum Forward Current	180	A
$P_D$	Maximum Power Dissipation @ $T_C = 25^\circ\text{C}$	349	W
	Maximum Power Dissipation @ $T_C = 100^\circ\text{C}$	174	W
$T_J$	Operating Junction Temperature	-55 to +175	$^\circ\text{C}$
$T_{stg}$	Storage Temperature Range	-55 to +175	$^\circ\text{C}$
$T_L$	Maximum Lead Temp. for soldering Purposes, 1/8" from case for 5 seconds	300	$^\circ\text{C}$

**Notes:**

1.  $V_{CC} = 400\text{ V}$ ,  $V_{GE} = 15\text{ V}$ ,  $I_C = 180\text{ A}$ ,  $R_G = 27\ \Omega$ , Inductive Load
2. Repetitive rating: Pulse width limited by max. junction temperature

FGH60T65SHD 650 V, 60 A Field Stop Trench IGBT

## Thermal Characteristics

Symbol	Parameter	FGH60T65SHD_F155	Unit
$R_{\theta JC}$ (IGBT)	Thermal Resistance, Junction to Case, Max.	0.43	$^{\circ}\text{C}/\text{W}$
$R_{\theta JC}$ (Diode)	Thermal Resistance, Junction to Case, Max.	1.25	$^{\circ}\text{C}/\text{W}$
$R_{\theta JA}$	Thermal Resistance, Junction to Ambient, Max.	40	$^{\circ}\text{C}/\text{W}$

## Package Marking and Ordering Information

Part Number	Top Mark	Package	Packing Method	Reel Size	Tape Width	Quantit
FGH60T65SHD_F155	FGH60T65SHD	TO-247 G03	Tube	-	-	30

## Electrical Characteristics of the IGBT $T_C = 25^{\circ}\text{C}$ unless otherwise noted

Symbol	Parameter	Test Conditions	Min.	Typ.	Max.	Unit
<b>Off Characteristics</b>						
$BV_{CES}$	Collector to Emitter Breakdown Voltage	$V_{GE} = 0\text{V}, I_C = 1\text{mA}$	650	-	-	V
$\Delta BV_{CES} / \Delta T_J$	Temperature Coefficient of Breakdown Voltage	$I_C = 1\text{mA}$ , Reference to $25^{\circ}\text{C}$	-	0.6	-	$\text{V}/^{\circ}\text{C}$
$I_{CES}$	Collector Cut-Off Current	$V_{CE} = V_{CES}, V_{GE} = 0\text{V}$	-	-	250	$\mu\text{A}$
$I_{GES}$	G-E Leakage Current	$V_{GE} = V_{GES}, V_{CE} = 0\text{V}$	-	-	$\pm 400$	nA
<b>On Characteristics</b>						
$V_{GE(th)}$	G-E Threshold Voltage	$I_C = 60\text{mA}, V_{CE} = V_{GE}$	4.0	5.5	7.5	V
$V_{CE(sat)}$	Collector to Emitter Saturation Voltage	$I_C = 60\text{A}, V_{GE} = 15\text{V}$	-	1.6	2.1	V
		$I_C = 60\text{A}, V_{GE} = 15\text{V}, T_C = 175^{\circ}\text{C}$	-	2.14	-	V
<b>Dynamic Characteristics</b>						
$C_{ies}$	Input Capacitance	$V_{CE} = 30\text{V}, V_{GE} = 0\text{V}, f = 1\text{MHz}$	-	2980	-	pF
$C_{oes}$	Output Capacitance		-	110	-	pF
$C_{res}$	Reverse Transfer Capacitance		-	36	-	pF
<b>Switching Characteristics</b>						
$t_{d(on)}$	Turn-On Delay Time	$V_{CC} = 400\text{V}, I_C = 60\text{A}, R_G = 6\Omega, V_{GE} = 15\text{V}, \text{Inductive Load}, T_C = 25^{\circ}\text{C}$	-	26	-	ns
$t_r$	Rise Time		-	48	-	ns
$t_{d(off)}$	Turn-Off Delay Time		-	87	-	ns
$t_f$	Fall Time		-	47	-	ns
$E_{on}$	Turn-On Switching Loss		-	1.69	-	mJ
$E_{off}$	Turn-Off Switching Loss		-	0.63	-	mJ
$E_{ts}$	Total Switching Loss		-	2.32	-	mJ
$t_{d(on)}$	Turn-On Delay Time	$V_{CC} = 400\text{V}, I_C = 60\text{A}, R_G = 6\Omega, V_{GE} = 15\text{V}, \text{Inductive Load}, T_C = 175^{\circ}\text{C}$	-	25	-	ns
$t_r$	Rise Time		-	60	-	ns
$t_{d(off)}$	Turn-Off Delay Time		-	93	-	ns
$t_f$	Fall Time		-	72	-	ns
$E_{on}$	Turn-On Switching Loss		-	2.54	-	mJ
$E_{off}$	Turn-Off Switching Loss		-	1.04	-	mJ
$E_{ts}$	Total Switching Loss		-	3.58	-	mJ

**Electrical Characteristics of the IGBT** (Continued)

Symbol	Parameter	Test Conditions	Min.	Typ.	Max	Unit
$Q_g$	Total Gate Charge	$V_{CE} = 400\text{ V}$ , $I_C = 60\text{ A}$ , $V_{GE} = 15\text{ V}$	-	102	-	nC
$Q_{ge}$	Gate to Emitter Charge		-	18.4	-	nC
$Q_{gc}$	Gate to Collector Charge		-	37.5	-	nC

**Electrical Characteristics of the Diode**  $T_C = 25^\circ\text{C}$  unless otherwise noted

Symbol	Parameter	Test Conditions	Min.	Typ.	Max	Unit	
$V_{FM}$	Diode Forward Voltage	$I_F = 30\text{ A}$	$T_C = 25^\circ\text{C}$	-	2.3	2.7	V
			$T_C = 175^\circ\text{C}$	-	1.9	-	
$E_{rec}$	Reverse Recovery Energy	$I_F = 30\text{ A}$ , $dI_F/dt = 200\text{ A}/\mu\text{s}$	$T_C = 175^\circ\text{C}$	-	50	-	$\mu\text{J}$
$t_{rr}$	Diode Reverse Recovery Time		$T_C = 25^\circ\text{C}$	-	34.6	-	ns
			$T_C = 175^\circ\text{C}$	-	197	-	
$Q_{rr}$	Diode Reverse Recovery Charge		$T_C = 25^\circ\text{C}$	-	58.6	-	nC
		$T_C = 175^\circ\text{C}$	-	810	-		

## Typical Performance Characteristics

Figure 1. Typical Output Characteristics

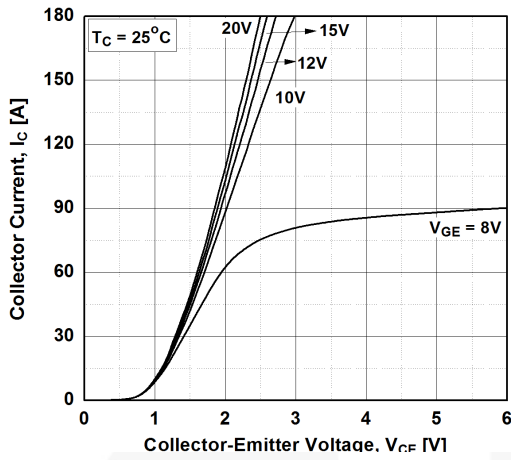


Figure 2. Typical Output Characteristics

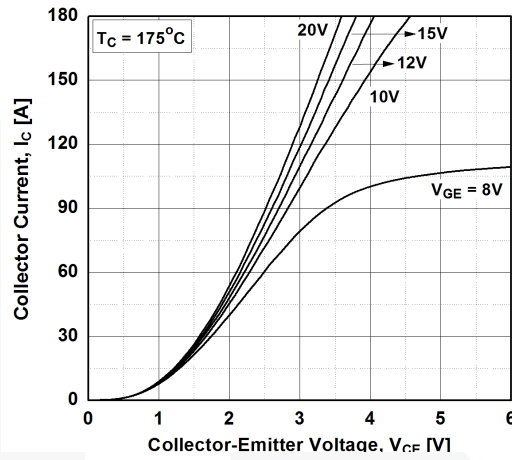


Figure 3. Typical Saturation Voltage Characteristics

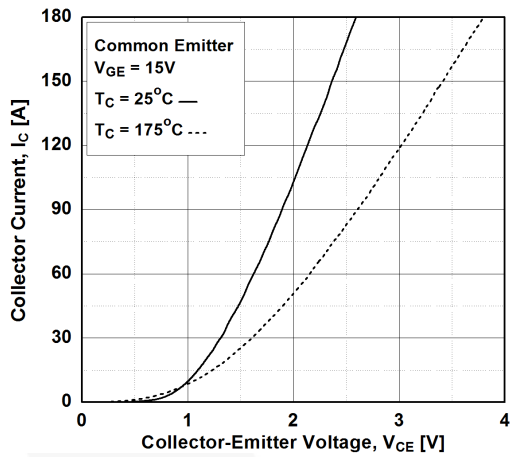


Figure 4. Saturation Voltage vs. Case Temperature at Variant Current Level

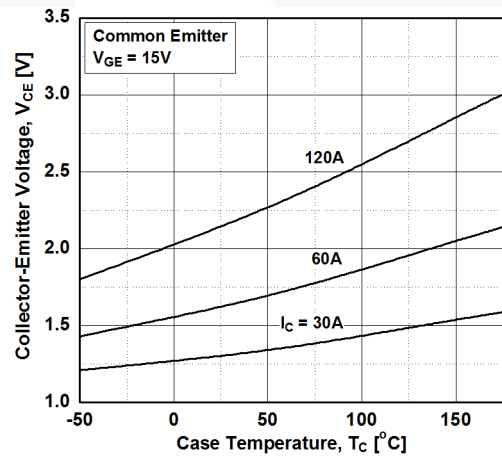


Figure 5. Saturation Voltage vs. Vge

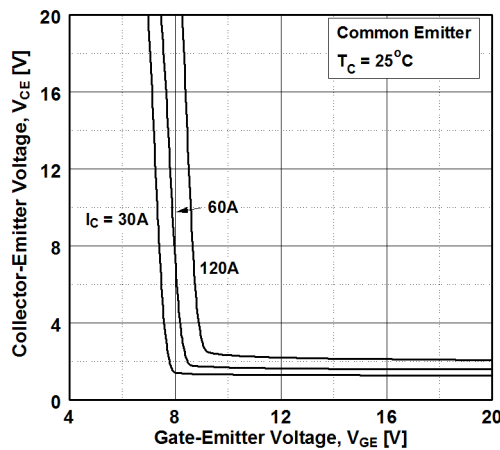
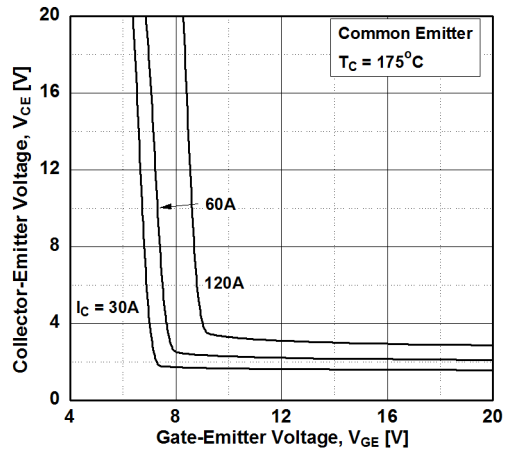
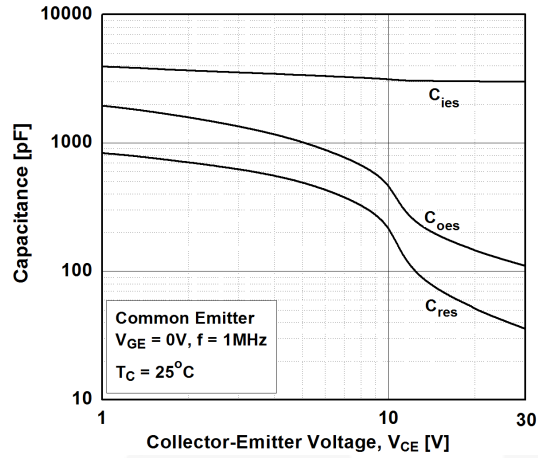


Figure 6. Saturation Voltage vs. Vge

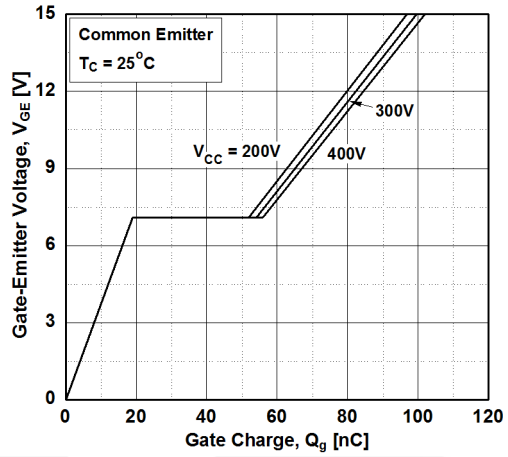


## Typical Performance Characteristics

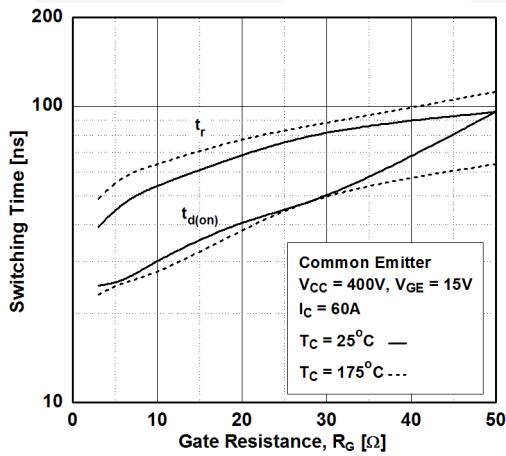
**Figure 7. Capacitance Characteristics**



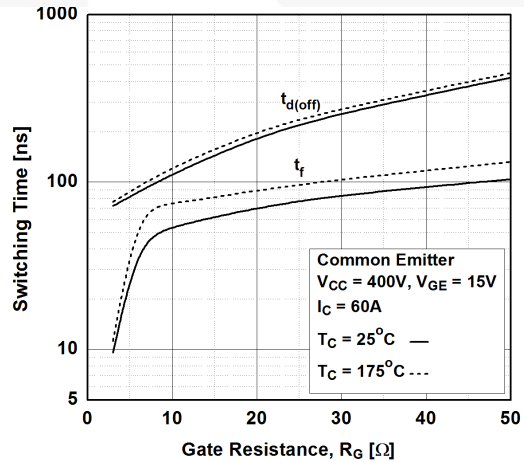
**Figure 8. Gate Charge Characteristics**



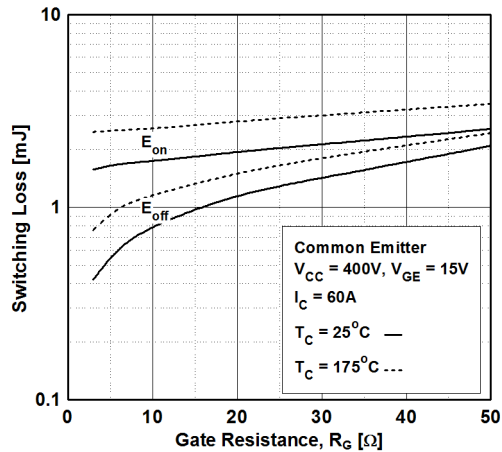
**Figure 9. Turn-on Characteristics vs. Gate Resistance**



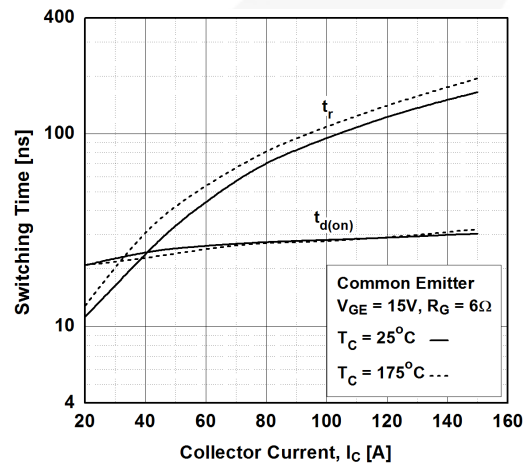
**Figure 10. Turn-off Characteristics vs. Gate Resistance**



**Figure 11. Switching Loss vs. Gate Resistance**

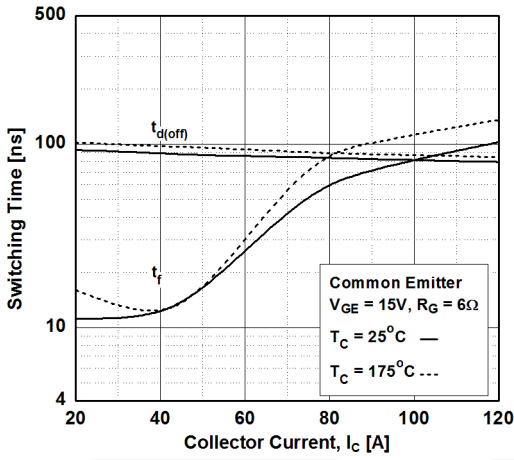


**Figure 12. Turn-on Characteristics vs. Collector Current**

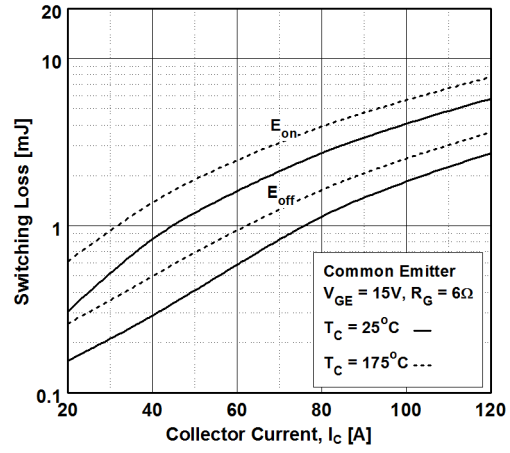


## Typical Performance Characteristics

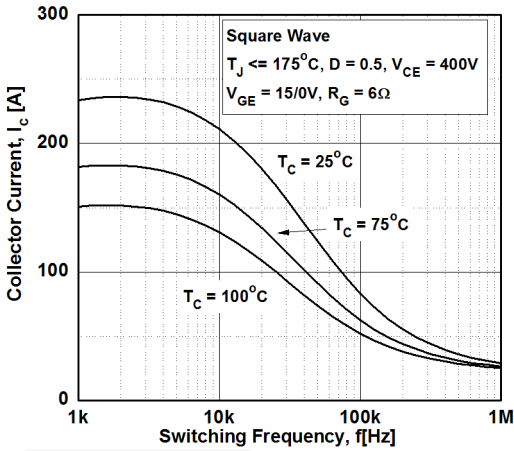
**Figure 13. Turn-off Characteristics vs. Collector Current**



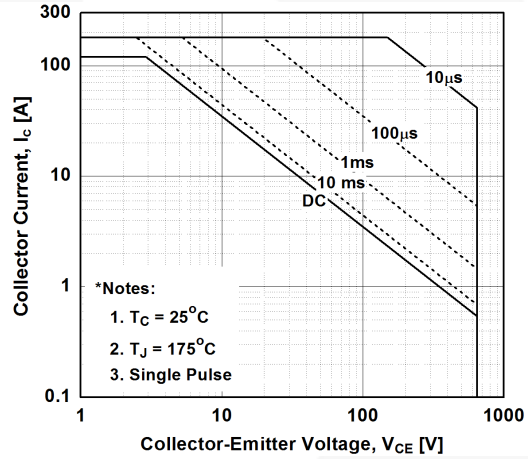
**Figure 14. Switching Loss vs. Collector Current**



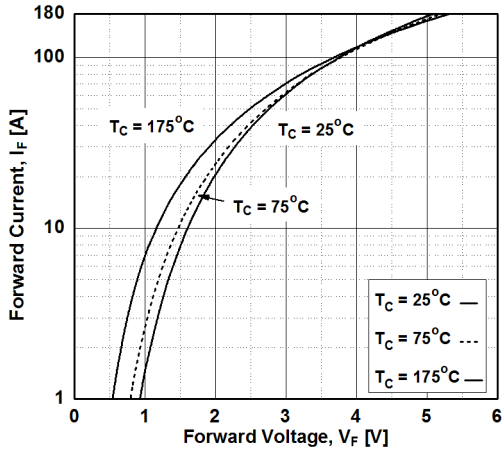
**Figure 15. Load Current Vs. Frequency**



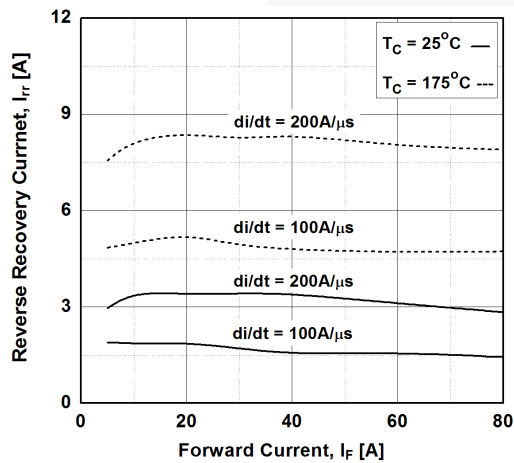
**Figure 16. SOA Characteristics**



**Figure 17. Forward Characteristics**



**Figure 18. Reverse Recovery Current**



## Typical Performance Characteristics

Figure 19. Reverse Recovery Time

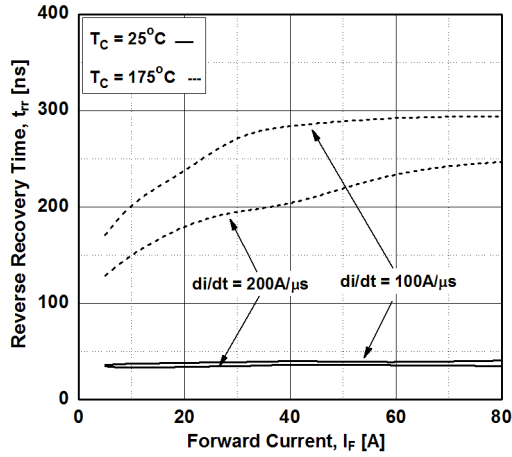


Figure 20. Stored Charge

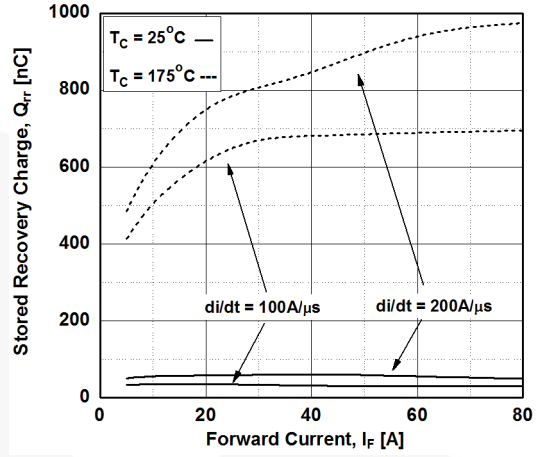


Figure 21. Transient Thermal Impedance of IGBT

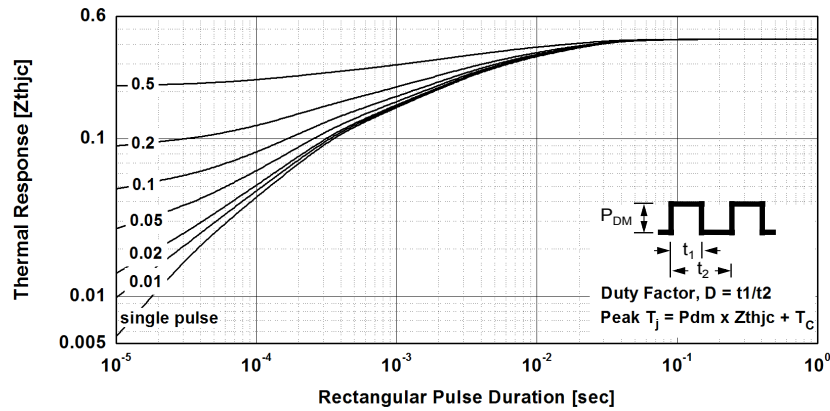
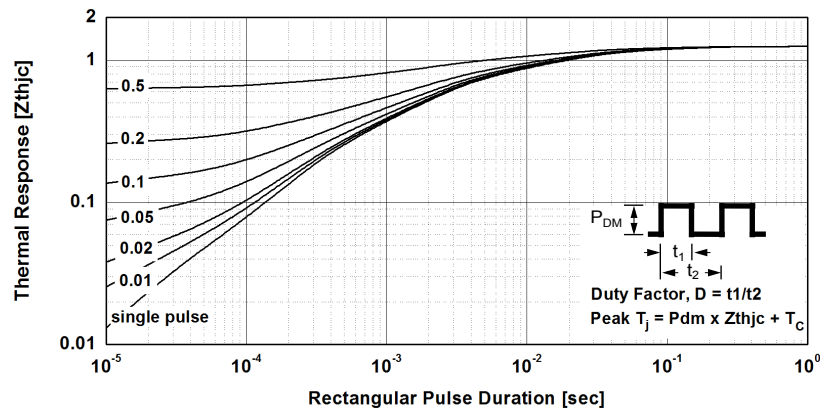
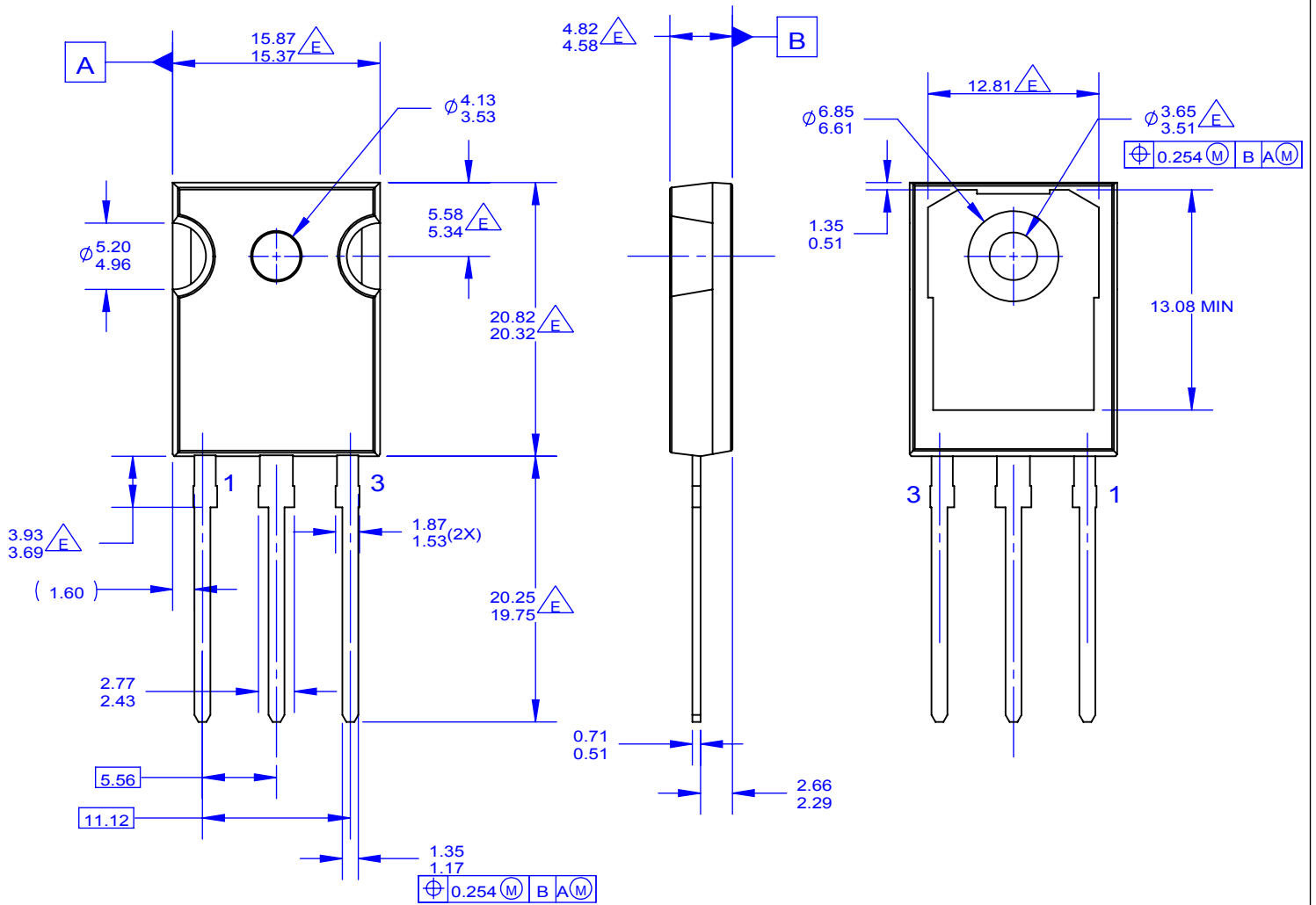


Figure 22. Transient Thermal Impedance of Diode







NOTES: UNLESS OTHERWISE SPECIFIED.

- A. PACKAGE REFERENCE: JEDEC TO-247, ISSUE E, VARIATION AB, DATED JUNE, 2004.
- B. DIMENSIONS ARE EXCLUSIVE OF BURRS, MOLD FLASH, AND TIE BAR EXTRUSIONS.
- C. ALL DIMENSIONS ARE IN MILLIMETERS.
- D. DRAWING CONFORMS TO ASME Y14.5 - 1994

$\triangle E$  DOES NOT COMPLY JEDEC STANDARD VALUE  
 F. DRAWING FILENAME: MKT-TO247G03\_REV02



ON Semiconductor and  are trademarks of Semiconductor Components Industries, LLC dba ON Semiconductor or its subsidiaries in the United States and/or other countries. ON Semiconductor owns the rights to a number of patents, trademarks, copyrights, trade secrets, and other intellectual property. A listing of ON Semiconductor's product/patent coverage may be accessed at [www.onsemi.com/site/pdf/Patent-Marking.pdf](http://www.onsemi.com/site/pdf/Patent-Marking.pdf). ON Semiconductor reserves the right to make changes without further notice to any products herein. ON Semiconductor makes no warranty, representation or guarantee regarding the suitability of its products for any particular purpose, nor does ON Semiconductor assume any liability arising out of the application or use of any product or circuit, and specifically disclaims any and all liability, including without limitation special, consequential or incidental damages. Buyer is responsible for its products and applications using ON Semiconductor products, including compliance with all laws, regulations and safety requirements or standards, regardless of any support or applications information provided by ON Semiconductor. "Typical" parameters which may be provided in ON Semiconductor data sheets and/or specifications can and do vary in different applications and actual performance may vary over time. All operating parameters, including "Typicals" must be validated for each customer application by customer's technical experts. ON Semiconductor does not convey any license under its patent rights nor the rights of others. ON Semiconductor products are not designed, intended, or authorized for use as a critical component in life support systems or any FDA Class 3 medical devices or medical devices with a same or similar classification in a foreign jurisdiction or any devices intended for implantation in the human body. Should Buyer purchase or use ON Semiconductor products for any such unintended or unauthorized application, Buyer shall indemnify and hold ON Semiconductor and its officers, employees, subsidiaries, affiliates, and distributors harmless against all claims, costs, damages, and expenses, and reasonable attorney fees arising out of, directly or indirectly, any claim of personal injury or death associated with such unintended or unauthorized use, even if such claim alleges that ON Semiconductor was negligent regarding the design or manufacture of the part. ON Semiconductor is an Equal Opportunity/Affirmative Action Employer. This literature is subject to all applicable copyright laws and is not for resale in any manner.

## PUBLICATION ORDERING INFORMATION

### LITERATURE FULFILLMENT:

Literature Distribution Center for ON Semiconductor  
19521 E. 32nd Pkwy, Aurora, Colorado 80011 USA  
**Phone:** 303-675-2175 or 800-344-3860 Toll Free USA/Canada  
**Fax:** 303-675-2176 or 800-344-3867 Toll Free USA/Canada  
**Email:** [orderlit@onsemi.com](mailto:orderlit@onsemi.com)

**N. American Technical Support:** 800-282-9855 Toll Free  
USA/Canada  
**Europe, Middle East and Africa Technical Support:**  
Phone: 421 33 790 2910  
**Japan Customer Focus Center**  
Phone: 81-3-5817-1050

**ON Semiconductor Website:** [www.onsemi.com](http://www.onsemi.com)  
**Order Literature:** <http://www.onsemi.com/orderlit>  
For additional information, please contact your local  
Sales Representative

# Mouser Electronics

Authorized Distributor

Click to View Pricing, Inventory, Delivery & Lifecycle Information:

[ON Semiconductor:](#)

[FGH60T65SHD\\_F155](#) [FGH60T65SHD-F155](#)



Компания «ЭлектроПласт» предлагает заключение долгосрочных отношений при поставках импортных электронных компонентов на взаимовыгодных условиях!

Наши преимущества:

- Оперативные поставки широкого спектра электронных компонентов отечественного и импортного производства напрямую от производителей и с крупнейших мировых складов;
- Поставка более 17-ти миллионов наименований электронных компонентов;
- Поставка сложных, дефицитных, либо снятых с производства позиций;
- Оперативные сроки поставки под заказ (от 5 рабочих дней);
- Экспресс доставка в любую точку России;
- Техническая поддержка проекта, помощь в подборе аналогов, поставка прототипов;
- Система менеджмента качества сертифицирована по Международному стандарту ISO 9001;
- Лицензия ФСБ на осуществление работ с использованием сведений, составляющих государственную тайну;
- Поставка специализированных компонентов (Xilinx, Altera, Analog Devices, Intersil, Interpoint, Microsemi, Aeroflex, Peregrine, Syfer, Eurofarad, Texas Instrument, Miteq, Cobham, E2V, MA-COM, Hittite, Mini-Circuits, General Dynamics и др.);

Помимо этого, одним из направлений компании «ЭлектроПласт» является направление «Источники питания». Мы предлагаем Вам помощь Конструкторского отдела:

- Подбор оптимального решения, техническое обоснование при выборе компонента;
- Подбор аналогов;
- Консультации по применению компонента;
- Поставка образцов и прототипов;
- Техническая поддержка проекта;
- Защита от снятия компонента с производства.



#### Как с нами связаться

**Телефон:** 8 (812) 309 58 32 (многоканальный)

**Факс:** 8 (812) 320-02-42

**Электронная почта:** [org@eplast1.ru](mailto:org@eplast1.ru)

**Адрес:** 198099, г. Санкт-Петербург, ул. Калинина, дом 2, корпус 4, литера А.