

# D2S

## Subminiature Basic Switch

### Subminiature Switch with Superb Flux Resistance

- One-piece terminal construction to keep out flux.
- High operating-position accuracy ( $\pm 0.25$  mm) enables easy peripheral design and positioning. Use of pin plunger also allows horizontal operation.

RoHS Compliant

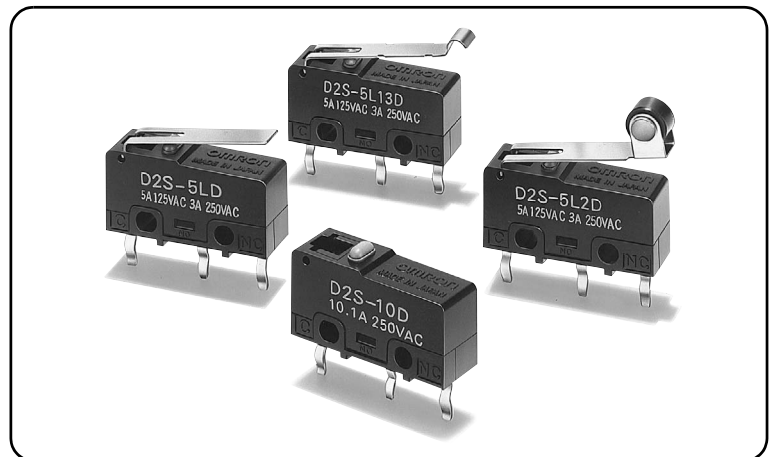

### Model Number Legend

D2S - 1 2 3 4

#### 1. Ratings

10: 250 VAC 10.1 A  
5 : 125 VAC 5 A  
01: 30 VDC 0.1 A

#### 2. Actuator

None: Pin plunger  
L : Hinge lever  
L13: Simulated roller lever  
L2 : Hinge roller lever





#### 3. Maximum Operating Force (OF)

None: 1.47 N {150 gf}  
-F : 0.49 N {50 gf} (For 0.1 A, 5 A)  
Note: The given values are for pin plunger models only.

#### 4. Terminals

None: Solder terminals  
D : Self-clinching PCB terminals

### List of Models

| Actuator                                                                                                      | Terminals                    | Ratings         | 10.1 A            | 5 A                | 0.1 A               |
|---------------------------------------------------------------------------------------------------------------|------------------------------|-----------------|-------------------|--------------------|---------------------|
|                                                                                                               |                              | OF max.         |                   |                    |                     |
| Pin plunger<br>            | Solder terminals             | 1.47 N {150 gf} | <b>D2S-10</b>     | <b>D2S-5</b>       | <b>D2S-01</b>       |
|                                                                                                               |                              | 0.49 N {50 gf}  | -                 | <b>D2S-5-F</b>     | <b>D2S-01-F</b>     |
|                                                                                                               | Self-clinching PCB terminals | 1.47 N {150 gf} | <b>D2S-10D</b>    | <b>D2S-5D</b>      | <b>D2S-01D</b>      |
|                                                                                                               |                              | 0.49 N {50 gf}  | -                 | <b>D2S-5-FD</b>    | <b>D2S-01-FD</b>    |
| Hinge lever<br>            | Solder terminals             | 0.49 N {50 gf}  | <b>D2S-10L</b>    | <b>D2S-5L</b>      | <b>D2S-01L</b>      |
|                                                                                                               |                              | 0.18 N {18 gf}  | -                 | <b>D2S-5L-F</b>    | <b>D2S-01L-F</b>    |
|                                                                                                               | Self-clinching PCB terminals | 0.49 N {50 gf}  | <b>D2S-10LD</b>   | <b>D2S-5LD</b>     | <b>D2S-01LD</b>     |
|                                                                                                               |                              | 0.18 N {18 gf}  | -                 | <b>D2S-5L-FD</b>   | <b>D2S-01L-FD</b>   |
| Simulated roller lever<br> | Solder terminals             | 0.49 N {50 gf}  | <b>D2S-10L13</b>  | <b>D2S-5L13</b>    | <b>D2S-01L13</b>    |
|                                                                                                               |                              | 0.18 N {18 gf}  | -                 | <b>D2S-5L13-F</b>  | <b>D2S-01L13-F</b>  |
|                                                                                                               | Self-clinching PCB terminals | 0.49 N {50 gf}  | <b>D2S-10L13D</b> | <b>D2S-5L13D</b>   | <b>D2S-01L13D</b>   |
|                                                                                                               |                              | 0.18 N {18 gf}  | -                 | <b>D2S-5L13-FD</b> | <b>D2S-01L13-FD</b> |
| Hinge roller lever<br>     | Solder terminals             | 0.49 N {50 gf}  | <b>D2S-10L2</b>   | <b>D2S-5L2</b>     | <b>D2S-01L2</b>     |
|                                                                                                               |                              | 0.18 N {18 gf}  | -                 | <b>D2S-5L2-F</b>   | <b>D2S-01L2-F</b>   |
|                                                                                                               | Self-clinching PCB terminals | 0.49 N {50 gf}  | <b>D2S-10L2D</b>  | <b>D2S-5L2D</b>    | <b>D2S-01L2D</b>    |
|                                                                                                               |                              | 0.18 N {18 gf}  | -                 | <b>D2S-5L2-FD</b>  | <b>D2S-01L2-FD</b>  |

Separator (Sold Separately), Terminal Connector (Sold Separately) ➔ Refer to "Basic Switch Common Accessories"

## Contact Form

### ●SPDT

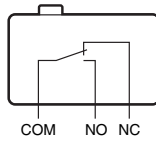

## Contact Specifications

| Item                                        | Model                | D2S-10 models | D2S-5 models | D2S-01 models |
|---------------------------------------------|----------------------|---------------|--------------|---------------|
| Contact                                     | Specification        | Rivet         |              | Crossbar      |
|                                             | Material             | Silver alloy  |              | Gold alloy    |
|                                             | Gap (standard value) | 0.5 mm        |              |               |
| Inrush current                              | NC                   | 20A max.      |              | 1 A max.      |
|                                             | NO                   | 15 A max.     | 10 A max.    | 1 A max.      |
| Minimum applicable load (reference value) * |                      | 5 VDC 160 mA  |              | 5 VDC 1 mA    |

\* Please refer to "Using Micro Loads" of "●Precautions" for more information on the minimum applicable load.

## Ratings

| Model         | Item Rated voltage | Resistive load |
|---------------|--------------------|----------------|
| D2S-10 models | 250 VAC            | 10.1 A         |
| D2S-5 models  | 125 VAC            | 5 A            |
|               | 250 VAC            | 3 A            |
| D2S-01 models | 125 VAC            | 0.1 A          |
|               | 30 VDC             | 0.1 A          |

Note. The above rating values apply under the following test conditions.  
 (1) Ambient temperature: 20±2°C  
 (2) Ambient humidity: 65±5%  
 (3) Operating frequency: 30 operations/min

## Approved Safety Standards

The items shown in the "List of Models" are not standard approved models. Consult your OMRON sales representative for specific models with standard approvals.

### UL (UL1054)/CSA(CSA C22.2 No.55)

| Rated voltage    | Model | D2S-10 | D2S-5      | D2S-01     |
|------------------|-------|--------|------------|------------|
| 125 VAC<br>250 V | -     | 10.1 A | 5 A<br>3 A | 0.1 A<br>- |
| 30 VDC           | -     | -      | -          | 0.1 A      |

## Characteristics

| Item                               | Model                                                       | D2S-10 models                                                                    | D2S-5 models                                   | D2S-01 models |
|------------------------------------|-------------------------------------------------------------|----------------------------------------------------------------------------------|------------------------------------------------|---------------|
| Permissible operating speed        |                                                             | 0.1 mm to 1 m/s (for pin plunger models)                                         |                                                |               |
| Permissible operating frequency    | Mechanical                                                  | 400 operations/min                                                               |                                                |               |
|                                    | Electrical                                                  | 60 operations/min                                                                |                                                |               |
| Insulation resistance              |                                                             | 100 MΩ min. (at 500 VDC with insulation tester)                                  |                                                |               |
| Contact resistance (initial value) | OF 1.47 N models                                            | 30mΩ max.                                                                        |                                                | 50 mΩ max.    |
|                                    | OF 0.49 N models                                            | -                                                                                | 50 mΩ max.                                     | 100 mΩ max.   |
| Dielectric strength * 1            | Between terminals of the same polarity                      | 1,000 VAC 50/60 Hz 1 min                                                         |                                                |               |
|                                    | Between current-carrying metal parts and ground             | 1,500 VAC 50/60 Hz 1 min                                                         |                                                |               |
|                                    | Between each terminals and non-current-carrying metal parts | 1,500 VAC 50/60 Hz 1 min                                                         |                                                |               |
| Vibration resistance * 2           | Malfunction                                                 | 10 to 55 Hz, 1.5 mm double amplitude                                             |                                                |               |
| Shock resistance                   | Durability                                                  | OF 1.47 N models                                                                 | 1,000 m/s <sup>2</sup> (approx. 100G) max.     |               |
|                                    |                                                             | OF 0.49 N models                                                                 | 500 m/s <sup>2</sup> (approx. 50G) max.        |               |
|                                    | Malfunction * 2                                             | OF 1.47 N models                                                                 | 300 m/s <sup>2</sup> (approx. 30G) max.        |               |
|                                    |                                                             | OF 0.49 models                                                                   | 200 m/s <sup>2</sup> (approx. 20G) max.        |               |
| Durability * 3                     | Mechanical                                                  | 10,000,000 operations min. (60 operations/min)                                   | 30,000,000 operations min. (60 operations/min) |               |
|                                    | Electrical                                                  | 50,000 operations min. (30 operations/min)                                       | 200,000 operations min. (30 operations/min)    |               |
| Degree of protection               |                                                             | IEC IP40                                                                         |                                                |               |
| Ambient operating temperature      |                                                             | -25°C to +85°C (at ambient humidity of 60% max.) (with no icing or condensation) |                                                |               |
| Ambient operating humidity         |                                                             | 85% max. (for +5°C to +35°C)                                                     |                                                |               |
| Weight                             |                                                             | Approx. 1.6 g (pin plunger models)                                               |                                                |               |

Note. The data given above are initial values.

- \*1. The values for dielectric strength shown are for models with a Separator (refer to "Micro Switch Common Accessories").
- \*2. The values are at Free Position and Total Travel Position values for pin plunger, and Total Travel Position value for lever. Close or open circuit of the contact is 1ms max.
- \*3. For testing conditions, consult your OMRON sales representative.

## Terminals/Apearances (Unit: mm)

### ●Solder terminals

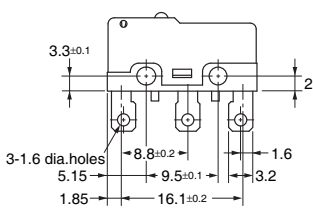

### ●Self-clinching PCB terminals

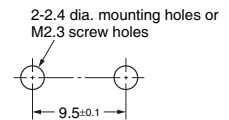
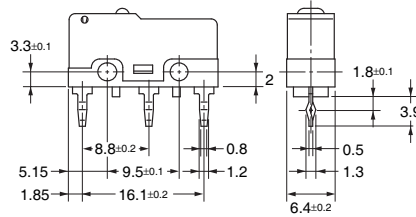

### <PCB Mounting Dimensions (Reference)>

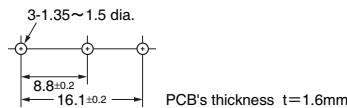

## Dimensions (Unit: mm) and Operating Characteristics

The following figures show models with self-clinching PCB terminals. For the solder terminals, refer to "Terminals/Apearances".

The □ is replaced with the code for the terminal that you need. See the "List of Models" for available combinations of models.

### ●Pin plunger

- D2S-10□
- D2S-5□
- D2S-5-F□
- D2S-01□
- D2S-01-F□

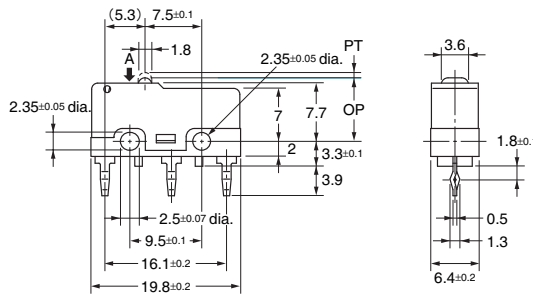

| Operating characteristics | Model |      | D2S-10□         | D2S-5-F□       |
|---------------------------|-------|------|-----------------|----------------|
|                           |       |      | D2S-5□          | D2S-01-F□      |
| Operating Force           | OF    | Max. | 1.47 N {150 gf} | 0.49 N {50 gf} |
| Releasing Force           | RF    | Min. | 0.25 N {25 gf}  | 0.04 N {4 gf}  |
| Pretravel                 | PT    | Max. | 0.7 mm          |                |
| Overtravel                | OT    | Min. | 0.4 mm          |                |
| Movement Differential     | MD    | Max. | 0.1 mm          |                |
| Operating Position        | OP    |      | 8.4±0.25 mm     |                |

### ●Hinge lever

- D2S-10L□
- D2S-5L□
- D2S-5L-F□
- D2S-01L□
- D2S-01L-F□

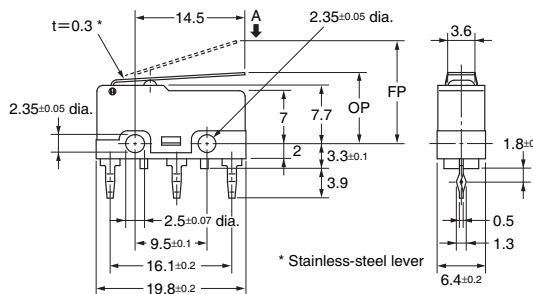

| Operating characteristics | Model |      | D2S-10L□       | D2S-5L-F□      |
|---------------------------|-------|------|----------------|----------------|
|                           |       |      | D2S-5L□        | D2S-01L-F□     |
| Operating Force           | OF    | Max. | 0.49 N {50 gf} | 0.18 N {18 gf} |
| Releasing Force           | RF    | Min. | 0.06 N {6 gf}  | 0.02 N {2 gf}  |
| Overtravel                | OT    | Min. | 1.0 mm         |                |
| Movement Differential     | MD    | Max. | 0.8 mm         |                |
| Free Position             | FP    | Max. | 13.6 mm        |                |
| Operating Position        | OP    |      | 9.4±0.8mm      |                |

### ●Simulated roller lever

- D2S-10L13□
- D2S-5L13□
- D2S-5L13-F□
- D2S-01L13□
- D2S-01L13-F□

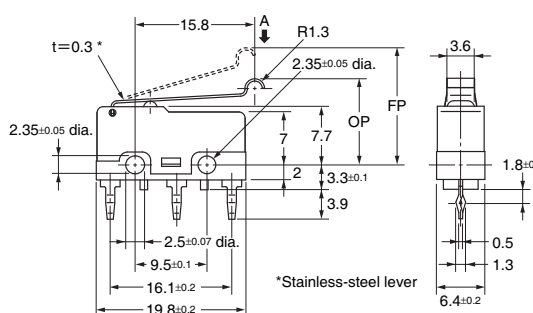
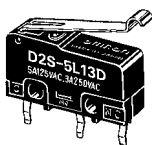

| Operating characteristics | Model |      | D2S-10L13□     | D2S-5L13-F□    |
|---------------------------|-------|------|----------------|----------------|
|                           |       |      | D2S-5L13□      | D2S-01L13-F□   |
| Operating Force           | OF    | Max. | 0.49 N {50 gf} | 0.18 N {18 gf} |
| Releasing Force           | RF    | Min. | 0.06 N {6 gf}  | 0.02 N {2 gf}  |
| Overtravel                | OT    | Min. | 1.0 mm         |                |
| Movement Differential     | MD    | Max. | 0.8 mm         |                |
| Free Position             | FP    | Max. | 15.5 mm        |                |
| Operating Position        | OP    |      | 11.4±0.8 mm    |                |

Note 1. Unless otherwise specified, a tolerance of ±0.4 mm applies to all dimensions.

Note 2. The operating characteristics are for operation in the A direction (↓).

●Hinge roller lever

- D2S-10L2□
- D2S-5L2□
- D2S-5L2-F□
- D2S-01L2□
- D2S-01L2-F□

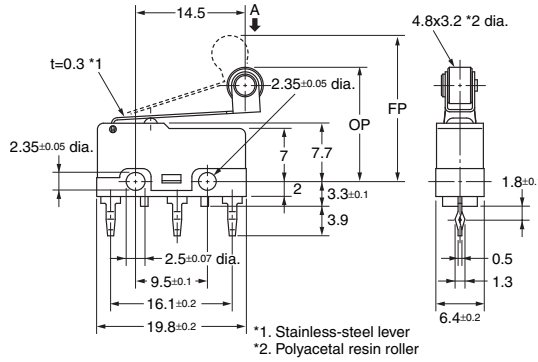
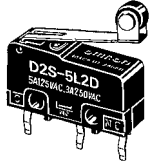

| Operating characteristics |         | Model | D2S-10L2□<br>D2S-5L2□<br>D2S-01L2□ | D2S-5L2-F□<br>D2S-01L2-F□ |
|---------------------------|---------|-------|------------------------------------|---------------------------|
| Operating Force           | OF Max. |       | 0.49 N {50 gf}                     | 0.18 N {18 gf}            |
| Releasing Force           | RF Min. |       | 0.06 N {6 gf}                      | 0.02 N {2 gf}             |
| Overtravel                | OT Min. |       | 1.0 mm                             |                           |
| Movement Differential     | MD Max. |       | 0.8 mm                             |                           |
| Free Position             | FP Max. |       | 19.3 mm                            |                           |
| Operating Position        | OP      |       | 15.1±0.8 mm                        |                           |

Note 1. Unless otherwise specified, a tolerance of ±0.4 mm applies to all dimensions.  
 Note 2. The operating characteristics are for operation in the A direction (↓).

## Precautions

★ Please refer to "Basic Switches Common Precautions" for correct use.

### Cautions

●Soldering

When using automatic soldering baths, we recommend soldering at 260±5°C within 5 seconds. Make sure that the liquid surface of the solder does not flow over the edge of the board.  
 When soldering terminals manually, complete the soldering at the iron tip temperature between 350 to 400°C within 3 seconds, and do not apply any external force for 1 minute after soldering.  
 When applying solder, keep the solder away from the case of the Switch and do not allow solder or flux to flow into the case.

### Correct Use

●Mounting

Use M2.3 mounting screw with plane washers or spring washers to securely mount the Switch. Tighten the screws to a torque of 0.23 to 0.26 N·m {2.3 to 2.7 kgf·cm}.

●Using Micro Loads

Using a model for ordinary loads to open or close the contact of a micro load circuit may result in faulty contact. Use models that operate in the following range. However, even when using micro load models within the following operating range, if inrush current occurs when the contact is opened or closed, it may increase the contact wear and so decrease durability. Therefore, insert a contact protection circuit where necessary. The N-level reference value applies for the minimum applicable load. This value indicates the malfunction reference level for the reliability level of 60% ( $\lambda_{60}$ ).

(JIS C5003)

The equation,  $\lambda_{60}=0.5 \times 10^{-6} / \text{operations}$  indicates that the estimated malfunction rate is less than  $\frac{1}{2,000,000}$  operations with a reliability level of 60%.

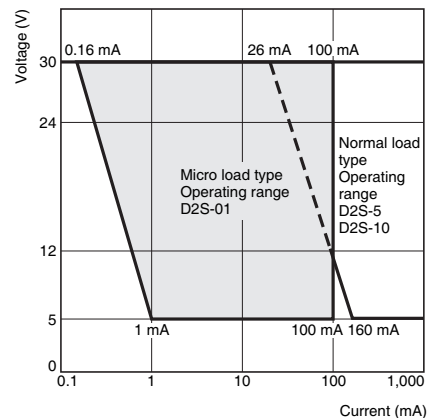

- Application examples provided in this document are for reference only. In actual applications, confirm equipment functions and safety before using the product.
- Consult your OMRON representative before using the product under conditions which are not described in the manual or applying the product to nuclear control systems, railroad systems, aviation systems, vehicles, combustion systems, medical equipment, amusement machines, safety equipment, and other systems or equipment that may have a serious influence on lives and property if used improperly. Make sure that the ratings and performance characteristics of the product provide a margin of safety for the system or equipment, and be sure to provide the system or equipment with double safety mechanisms.

**Note: Do not use this document to operate the Unit.**



Компания «ЭлектроПласт» предлагает заключение долгосрочных отношений при поставках импортных электронных компонентов на взаимовыгодных условиях!

Наши преимущества:

- Оперативные поставки широкого спектра электронных компонентов отечественного и импортного производства напрямую от производителей и с крупнейших мировых складов;
- Поставка более 17-ти миллионов наименований электронных компонентов;
- Поставка сложных, дефицитных, либо снятых с производства позиций;
- Оперативные сроки поставки под заказ (от 5 рабочих дней);
- Экспресс доставка в любую точку России;
- Техническая поддержка проекта, помощь в подборе аналогов, поставка прототипов;
- Система менеджмента качества сертифицирована по Международному стандарту ISO 9001;
- Лицензия ФСБ на осуществление работ с использованием сведений, составляющих государственную тайну;
- Поставка специализированных компонентов (Xilinx, Altera, Analog Devices, Intersil, Interpoint, Microsemi, Aeroflex, Peregrine, Syfer, Eurofarad, Texas Instrument, Miteq, Cobham, E2V, MA-COM, Hittite, Mini-Circuits, General Dynamics и др.);

Помимо этого, одним из направлений компании «ЭлектроПласт» является направление «Источники питания». Мы предлагаем Вам помощь Конструкторского отдела:

- Подбор оптимального решения, техническое обоснование при выборе компонента;
- Подбор аналогов;
- Консультации по применению компонента;
- Поставка образцов и прототипов;
- Техническая поддержка проекта;
- Защита от снятия компонента с производства.



#### Как с нами связаться

**Телефон:** 8 (812) 309 58 32 (многоканальный)

**Факс:** 8 (812) 320-02-42

**Электронная почта:** [org@eplast1.ru](mailto:org@eplast1.ru)

**Адрес:** 198099, г. Санкт-Петербург, ул. Калинина, дом 2, корпус 4, литера А.