



Typical unit

FEATURES

- iLGA inspectable Land Grid Array
- 2.4-5.5Vdc input voltage range
- Programmable output voltage from 0.6-3.63Vdc
- Drives 1000µF ceramic capacitive loads
- High power conversion efficiency at 93%
- Outstanding thermal derating performance
- Over temperature and over current protection
- On/Off control
- RoHS-6 hazardous substance compliance
- Optional Sequence/Tracking operation

PRODUCT OVERVIEW

The OKL2-T/20-W5 series are non-isolated point-of-Load(PoL) DC-DC power Converters for embedded applications. The tiny form factor is configured on a Land Grid Array (LGA) assembly measuring only 1.3 x 0.53 x 0.34 inches (33.02 x 13.46 x 8.75 mm). Applications include powering CPU's, datacom/telecom systems, distributed bus architectures (DBA), programmable logic and mixed voltage systems.

The wide input range is 2.4 to 5.5Volts DC.

The maximum output current is 20Amps. Based on fixed-frequency synchronous buck converter switching topology, the high power conversion efficient Point of Load (PoL) module features programmable output voltage and On/Off control.

These converters also include under voltage lock out (UVLO), output short circuit protection, over-current and over temperature protections.

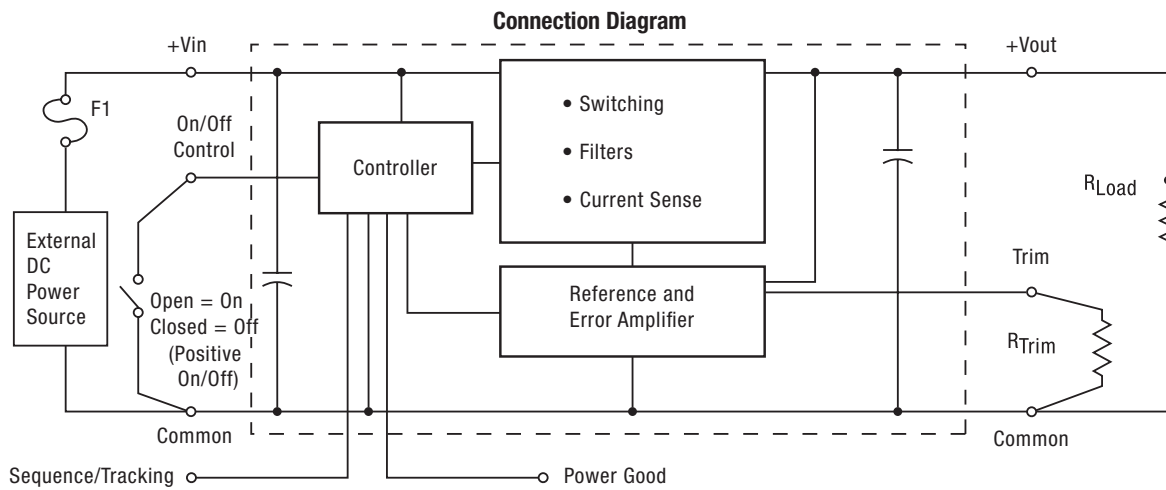

Figure 1. OKL2-T/20-W5

Note: Murata Power Solutions strongly recommends an external input fuse, F1. See specifications.



PERFORMANCE SPECIFICATIONS SUMMARY AND ORDERING GUIDE															
Model Number	Output					Input				Efficiency (%)		On/Off Logic	Seq/Track	Dimensions	
	Vout (Volts) ①	Iout (Amps, max.) ②	Power (Watts)	R/N (mV p-p) Max. ④	Regulation (max.)		Vin nom. (Volts)	Range (Volts) ④	Iin, no load (mA) ④	Iin, full load (Amps) ②	Min.			Typ.	Inches (mm)
					Line	Load									
OKL-T/20-W5P-C	0.6-3.63	20	66	35	±0.6%	±0.3%	5	2.4-5.5	63	14.18	91.0	93.1	Pos.	no	1.3 x 0.53 x 0.34 (33.02 x 13.46 x 8.75)
OKL-T/20-W5N-C													Neg.	no	
OKL2-T/20-W5P-C													Pos.	yes	
OKL2-T/20-W5N-C													Neg.	yes	

- ① The output range is limited by Vin. See detailed specs.
- ② All specifications are at nominal line voltage, Vout=nominal (3.3V) and full load, +25°C, unless otherwise noted.
Output capacitors are 2 x 47µF. Input cap is 22 µF. See detailed specifications. I/O caps are necessary for our test equipment and may not be needed for your application.
- ③ Use adequate ground plane and copper thickness adjacent to the converter.
- ④ Ripple and Noise (R/N) and no-load input current are shown at Vout=1V. See specs for details.

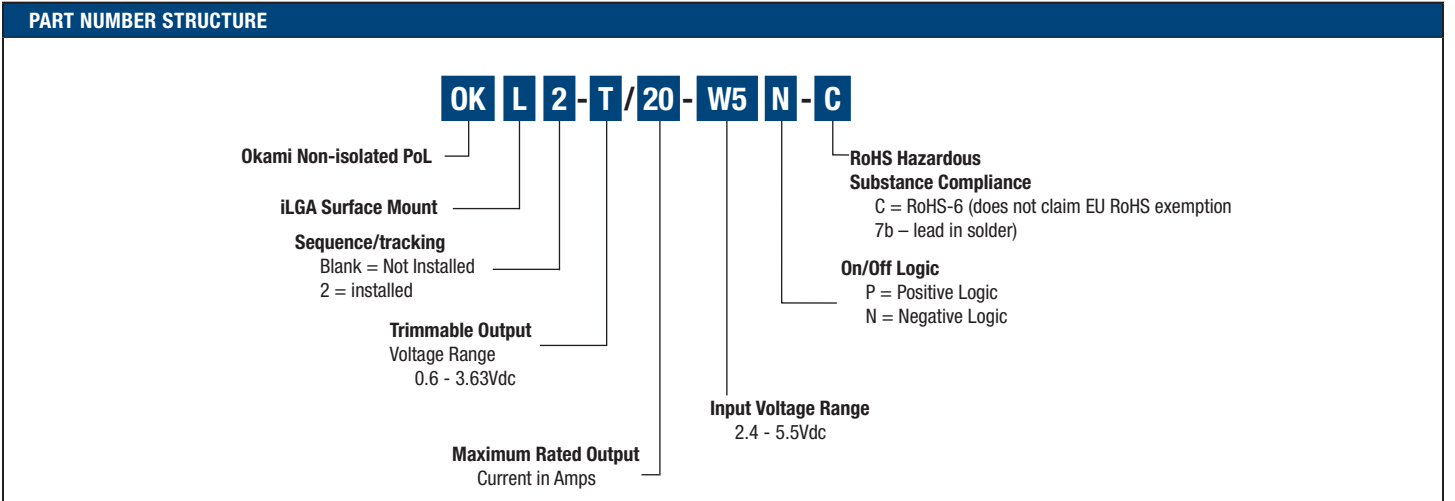

Product Label

Because of the small size of these products, the product label contains a character-reduced code to indicate the model number and manufacturing date code. Not all items on the label are always used. Please note that the label differs from the product photograph. Here is the layout of the label:

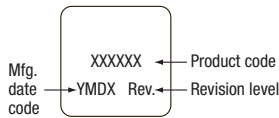

Figure 2. Label Artwork Layout

The label contains two rows of information:

- First row – Model number product code (see table)
- Second row – Manufacturing date code and revision level

Model Number	Product Code
OKL-T/20-W5P-C	L01020
OKL-T/20-W5N-C	L00020
OKL2-T/20-W5P-C	L21020
OKL2-T/20-W5N-C	L20020

The manufacturing date code is four characters:

- First character – Last digit of manufacturing year, example 2009
- Second character – Month code (1 through 9 = Jan-Sep; O, N, D = Oct, Nov, Dec)
- Third character – Day code (1 through 9 = 1 to 9, 10 = 0 and 11 through 31 = A through Z)
- Fourth character – Manufacturing information

FUNCTIONAL SPECIFICATIONS

ABSOLUTE MAXIMUM RATINGS	Conditions (1)	Minimum	Typical/Nominal	Maximum	Units
Input Voltage, Continuous	Full power operation	0		6	Vdc
Output Power		0		72.6	W
Output Current	Current-limited, no damage, short-circuit protected	0		20	A
On/Off Control				5.5	Vdc
Sequence Pin				Vin max	Vdc
Storage Temperature Range	Vin = Zero (no power)	-55		125	°C

Absolute maximums are stress ratings. Exposure of devices to greater than any of these conditions may adversely affect long-term reliability. Proper operation under conditions other than those listed in the Performance/Functional Specifications Table is not implied or recommended.

INPUT					
Operating voltage range (7)	See output voltage vs input voltage	2.4	5	5.5	Vdc
Recommended External Fuse	Fast blow			34	A
Turn On/Start-up threshold	Rising input voltage	1.95	2.05	2.15	Vdc
Undervoltage Shutdown		1.8	1.92	2.07	
Internal Filter Type			C-TYPE		
Input current					
Full Load Conditions	Vin = nominal (3.3Vo set)		14.18	14.72	A
Low Line	Vin @ min, 3.3 Vout		15.72	16.36	A
Inrush Transient			TBD		A ² -Sec.
Short Circuit Input Current			50		mA
No Load Input Current	3.3Vout, Iout @ 0		63	90	mA
No Load Input Current	1.2V, Iout @ 0		59	86	mA
Shut-Down Mode Input Current			1		mA
Reflected (back) ripple current (2)	Measured at input with specified filter		TBD		mA, pk-pk

GENERAL and SAFETY					
EFFICIENCY (5Vin @ 20A load current)	@ Vin nom, 3.63Vout	91.5	93.6		%
	@ Vin nom, 3.3Vout	91	93.1		
	@ Vin min=4.5Vin, 3.3Vout	91	93.3		
	@Vin nom, 1.8Vout	84	88.4		
	@Vin nom, 1.2Vout	80	84.2		
Safety	Certified to UL-60950-1, CSA-C22.2 No.60950-1, IEC/60950-1, 2nd edition (pending)		Yes		
Calculated MTBF (4a)	Per Telcordia SR332, issue 1 class 3, ground fixed, Tambient=+25°C		6,355,830		Hours
Calculated MTBF (4b)	Per Mil-HDBK-217N2 Method		4,941,433		Hours

DYNAMIC CHARACTERISTICS					
Fixed Switching Frequency			600		KHz
Startup Time	Power On to Vout regulated			6	mS
Startup Time	Remote ON to Vout regulated			6	mS
Dynamic Load Response	50-100-50% load step, settling time to within ±2% of Vout di/dt = 1 A/µSec		50		µSec
Dynamic Load Peak Deviation	same as above		±300		mV

FEATURES and OPTIONS					
Remote On/Off Control (5)					
"N" suffix					
Negative Logic, ON state	Pin open=ON	-0.2		Vin-1.7	V
Negative Logic, OFF state		Vin-0.7		+Vin-max	V
Control Current	open collector/drain			3	mA
"P" suffix					
Positive Logic, ON state	Pin open=ON	+Vin-0.7V		Vin-max	V
Positive Logic, OFF state		-0.3		0.8	V
Control Current	open collector/drain			3	mA
Tracking/Sequencing(optional)					
Slew Rate				2	V/mS
Tracking Accuracy	Rising input (0.5V/ms)		±150		mV
Tracking Accuracy	Falling input(0.5V/ms)		±100		mV
Power Good Option					
PGOOD, Open Drain Configuration, Sinking:					
Vout window for PGOOD: True		-10%		10%	Vset
Vout window for PGOOD: False			0.05		Vdc
Remote Sense				500	mV

FUNCTIONAL SPECIFICATIONS (CONT.)

OUTPUT						
Total Output Power			0	66	72.6	W
Voltage						
Nominal Output Voltage Range (13)	See trim formula		0.6		3.63	Vdc
Setting Accuracy	At 50% load		-1.5		1.5	% of Vnom.
Output Voltage Overshoot-Startup					3	% Vo set
Current						
Output Current Range			0	20	20	A
Minimum Load				No minimum load		
Current Limit Inception (6)	98% of Vnom., after warmup		20.2	33		A
Short Circuit						
Short Circuit Current (17)	Hiccup technique, autorecovery within $\pm 1\%$ of Vout			0.02		A
Short Circuit Duration (remove short for recovery)	Output shorted to ground, no damage			Continuous		
Short circuit protection method	Current limiting					
Regulation (10)						
Total Regulation Band			-2.5	Vo set	2.5	% Vo set
Line Regulation	Vin=min. to max. Vout=nom.				± 0.6	%
Load Regulation	Iout=min. to max.				± 0.3	%
Ripple and Noise (8)	3.3Vo, 12Vin			40	100	mV pk-pk
	2.5Vo, 12Vin			35	100	
	1.8Vo, 12Vin			35	100	
	0.6Vo, 7Vin			30	100	
Temperature Coefficient	At all outputs			± 0.02		% of Vnom./ $^{\circ}\text{C}$
Maximum Capacitive Loading (14)	Low ESR; $>0.001, <0.01$ ohm		94		1000	μF
	ESR > 0.01 ohm				10000	μF
MECHANICAL						
Outline Dimensions				1.3X0.53X0.34		Inches
				33.02x13.46x8.75		mm
Weight				0.2		Ounces
				5.4		Grams
ENVIRONMENTAL						
Operating Ambient Temperature Range (9)	full power, all output voltages, see derating curves		-40		85	$^{\circ}\text{C}$
Storage Temperature	Vin = Zero (no power)		-55		125	$^{\circ}\text{C}$
Thermal Protection/Shutdown	Measured in center			TBD		$^{\circ}\text{C}$
RoHS rating				RoHS-6		

Notes

- (1) Specifications are typical at $+25^{\circ}\text{C}$, Vin = nominal (+5V), Vout = nominal (+3.3V), full load, external caps and natural convection unless otherwise indicated. Extended tests at full power must supply substantial forced airflow. All models are tested and specified with external $2 \times 47 \mu\text{F}$ ceramic output capacitors and a $22 \mu\text{F}$ external input capacitor. All capacitors are low ESR types. These capacitors are necessary to accommodate our test equipment and may not be required to achieve specified performance in your applications. However, Murata Power Solutions recommends installation of these capacitors. All models are stable and regulate within spec under no-load conditions.
- (2) Input Back Ripple Current is tested and specified over a 5 Hz to 20 MHz bandwidth. Input filtering is Cin = $2 \times 100 \mu\text{F}$ ceramic, Cbus = $1000 \mu\text{F}$ electrolytic, Lbus = $1 \mu\text{H}$.
- (3) Note that Maximum Power Derating curves indicate an average current at nominal input voltage. At higher temperatures and/or lower airflow, the DC-DC converter will tolerate brief full current outputs if the total RMS current over time does not exceed the Derating curve.
- (4a) Mean Time Before Failure is calculated using the Telcordia (Belcore) SR-332 Method 1, Case 3, ground fixed conditions, Tpcboard = $+25^{\circ}\text{C}$, full output load, natural air convection.
- (4b) Mean Time Before Failure is calculated using the MIL-HDBK-217N2 method, ground benign, $+25^{\circ}\text{C}$, full output load, natural convection.
- (5) The On/Off Control Input should use either a switch or an open collector/open drain transistor referenced to -Input Common. A logic gate may also be used by applying appropriate external voltages which do not exceed +Vin.
- (6) Short circuit shutdown begins when the output voltage degrades approximately 2% from the selected setting.
- (7) Please observe the voltage input and output specifications in the voltage range graph.
- (8) Output noise may be further reduced by adding an external filter. At zero output current, the output may contain low frequency components which exceed the ripple specification. The output may be operated indefinitely with no load.
- (9) All models are fully operational and meet published specifications, including "cold start" at -40°C .
- (10) Regulation specifications describe the deviation as the line input voltage or output load current is varied from a nominal midpoint value to either extreme.
- (11) Other input or output voltage ranges will be reviewed under scheduled quantity special order.
- (12) Maximum PC board temperature is measured with the sensor in the center of the converter.
- (13) Do not exceed maximum power specifications when adjusting the output trim.
- (14) The maximum output capacitive loads depend on the the Equivalent Series Resistance (ESR) of the external output capacitor and, to a lesser extent, the distance and series impedance to the load. Larger caps will reduce output noise but may change the transient response. Newer ceramic caps with very low ESR may require lower capacitor values to avoid instability. Thoroughly test your capacitors in the application. Please refer to the Output Capacitive Load Technical Note.
- (15) Do not allow the input voltage to degrade lower than the input undervoltage shutdown voltage at all times. Otherwise, you risk having the converter turn off. The undervoltage shutdown is not latching and will attempt to recover when the input is brought back into normal operating range.
- (16) The outputs are not intended to sink appreciable reverse current.
- (17) "Hiccup" overcurrent operation repeatedly attempts to restart the converter with a brief, full-current output. If the overcurrent condition still exists, the restart current will be removed and then tried again. This short current pulse prevents overheating and damaging the converter. Once the fault is removed, the converter immediately recovers normal operation.

OKL2-T/20-W5 PERFORMANCE DATA AND OSCILLOGRAMS

Efficiency vs. Line Voltage and Load Current @Ta = +25 °C (Vout = 3.3V)

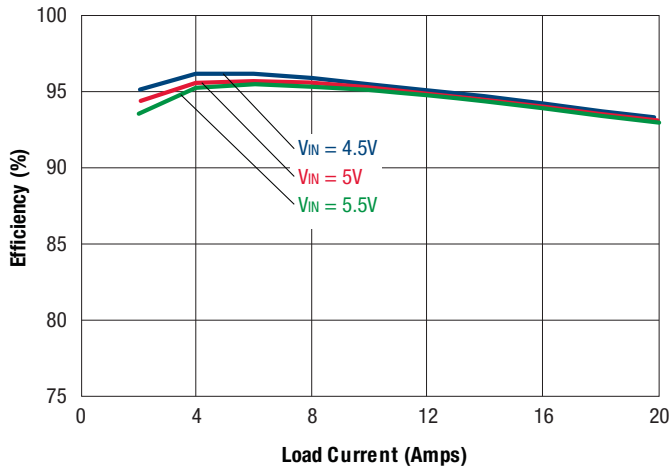

Maximum Current Temperature Derating at Sea Level (Vin=5V, Vout=3.3V)

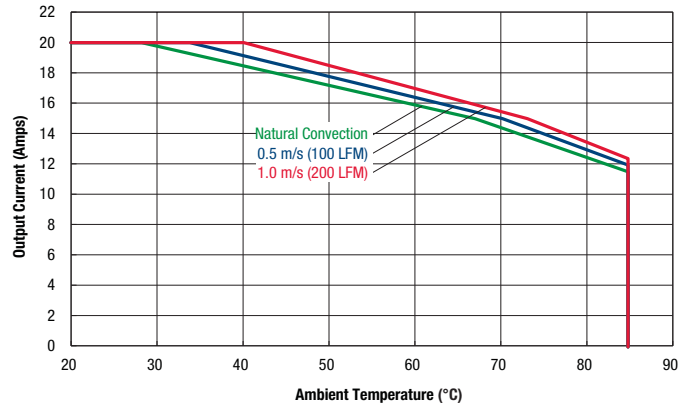

On/Off Enable Delay (Vin=5.0V, Vout=3.3V, Iout=20A, Cload=94µF) Trace2=Enable, Trace1=Vout

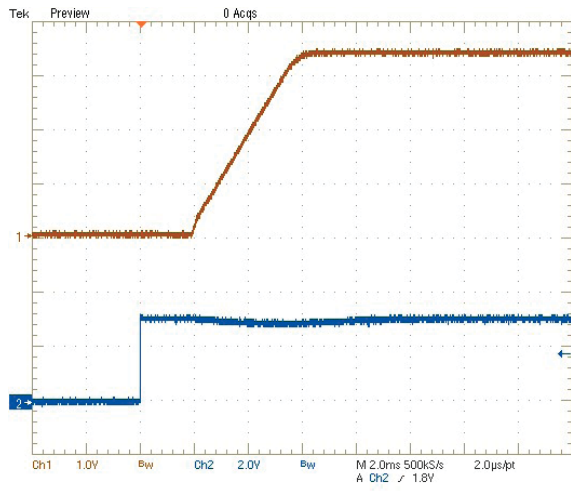

Output Ripple and Noise (Vin=5.0V, Vout=3.3V, Iout=20A, Cload=94µF, ScopeBW=20MHz)

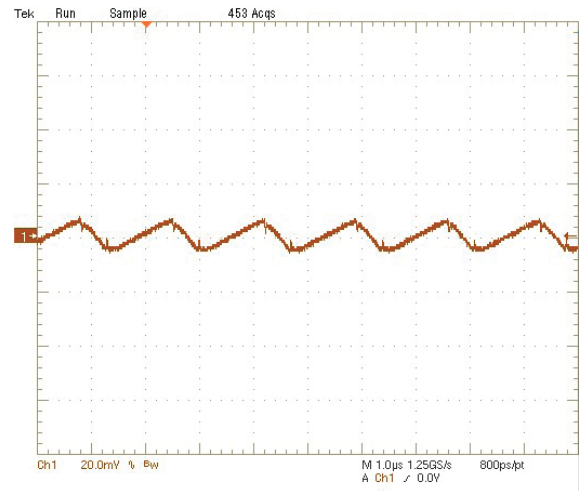

Step Load Transient Response (Vin=5.0V, Vout=3.3V, Cload=94µF, Iout=6A to 12A) Trace 1=Vout, 200 mV/div, Trace 4=Iout, 10A/div.

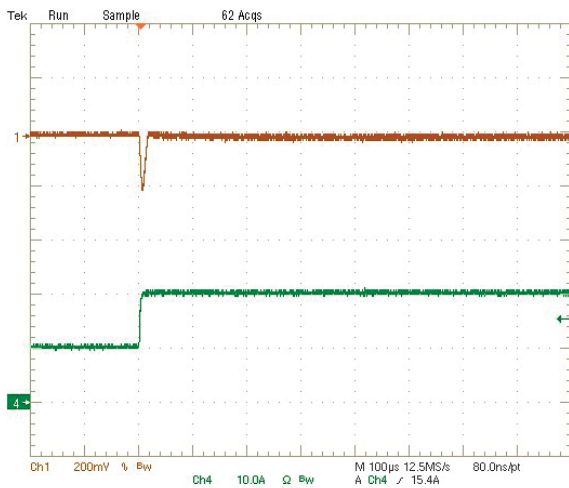

Step Load Transient Response (Vin=5.0V, Vout=3.3V, Cload=94µF, Iout=20A to 10A) Trace 1=Vout, 200 mV/div, Trace 4=Iout, 10A/div.

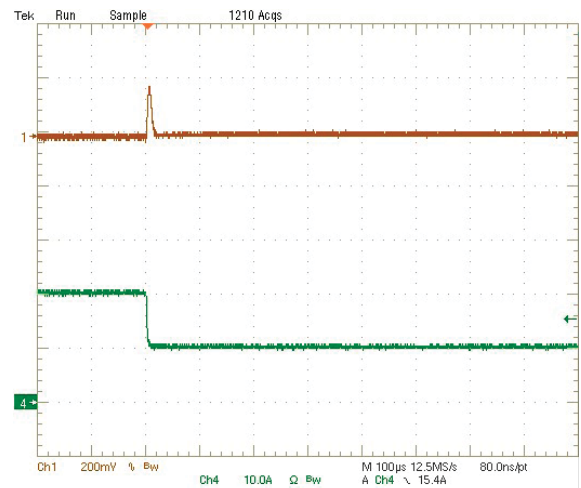

OKL2-T/20-W5 PERFORMANCE DATA AND OSCILLOGRAMS

Efficiency vs. Line Voltage and Load Current @Ta = +25 °C (Vout = 2.5V)

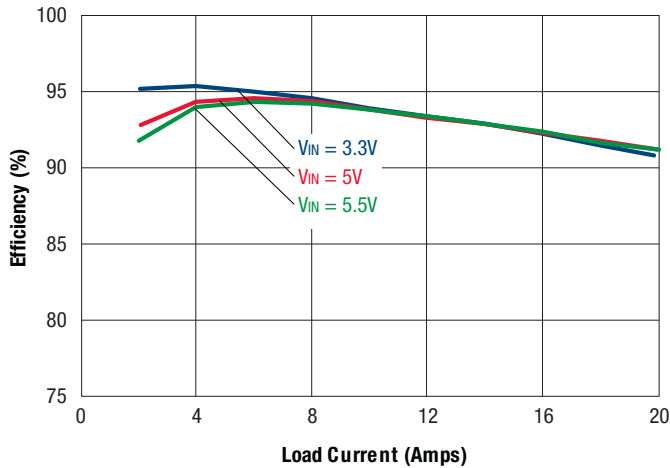

Maximum Current Temperature Derating at Sea Level (Vin=5V, Vout=2.5V)

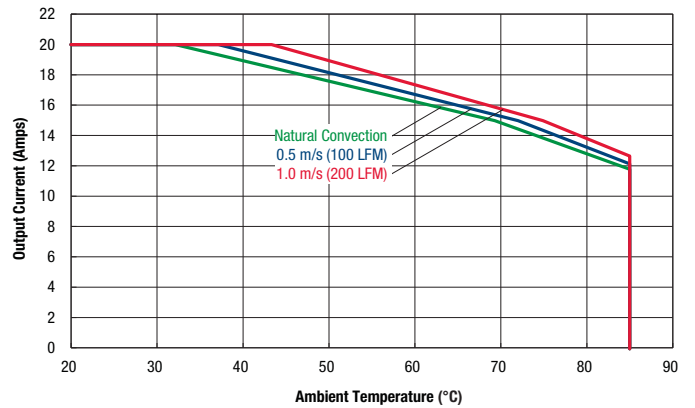

On/Off Enable Delay (Vin=5.0V, Vout=2.5V, Iout=20A, Cload=94µF) Trace2=Enable, Trace1=Vout

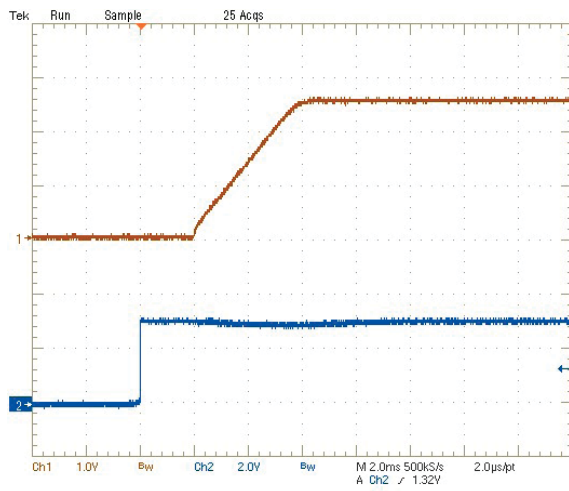

Output Ripple and Noise (Vin=5.0V, Vout=2.5V, Iout=20A, Cload=94µF, ScopeBW=20MHz)

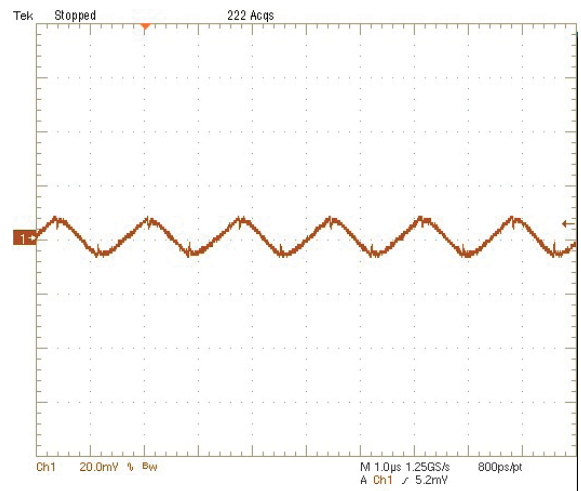

Step Load Transient Response (Vin=5.0V, Vout=2.5V, Cload=94µF, Iout=6A to 12A) Trace 1=Vout, 200 mV/div, Trace 4=Iout, 10A/div.

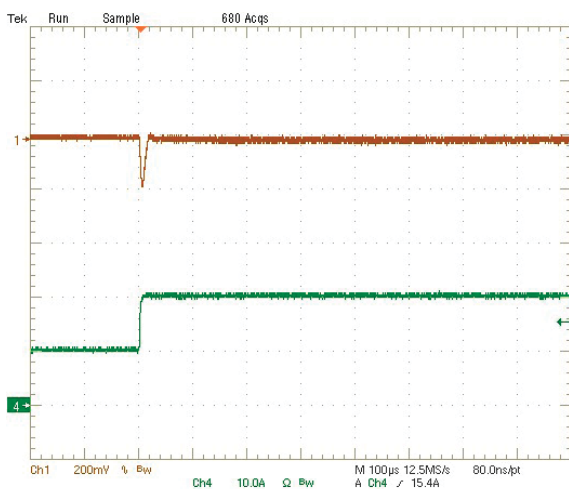

Step Load Transient Response (Vin=5.0V, Vout=2.5V, Cload=94µF, Iout=20A to 10A) Trace 1=Vout, 200 mV/div, Trace 4=Iout, 10A/div.

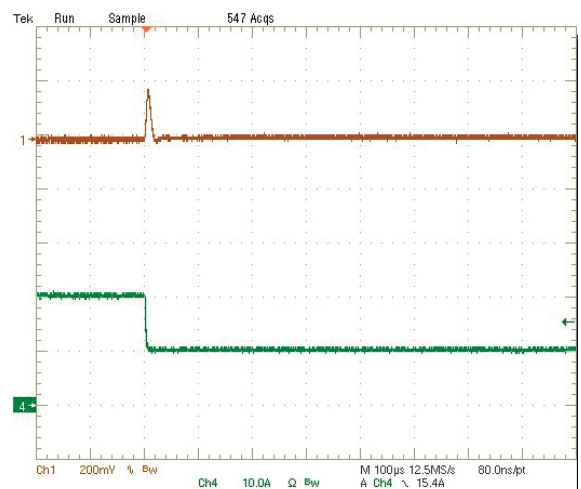

OKL2-T/20-W5 PERFORMANCE DATA AND OSCILLOGRAMS

Efficiency vs. Line Voltage and Load Current @Ta = +25 °C (Vout = 1.8V)

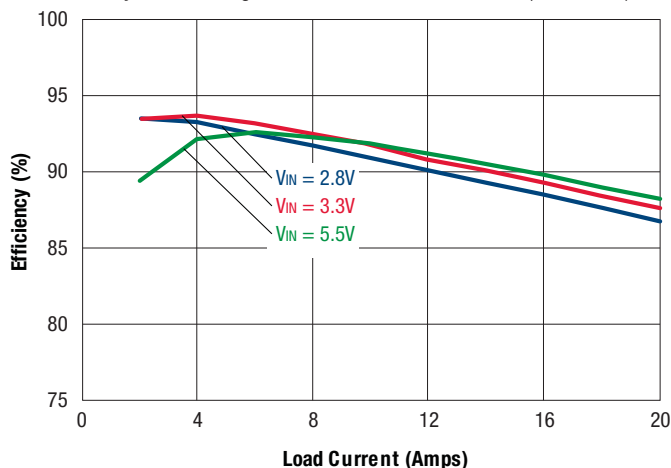

Maximum Current Temperature Derating at Sea Level (Vin=5V, Vout=1.8V)

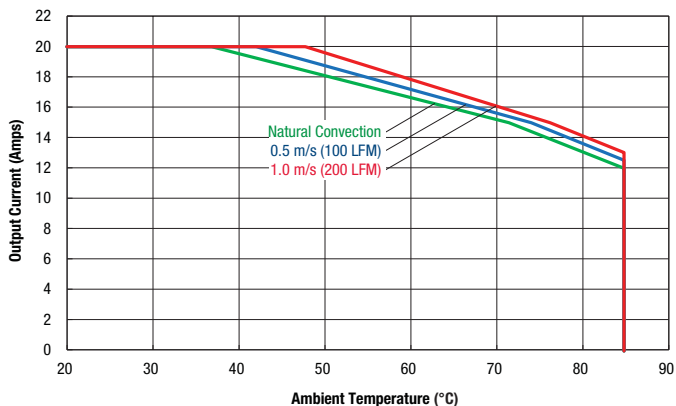

On/Off Enable Delay (Vin=5.0V, Vout=1.8V, Iout=20A, Cload=94µF) Trace2=Enable, Trace1=Vout



Output Ripple and Noise (Vin=5.0V, Vout=1.8V, Iout=20A, Cload=94µF, ScopeBW=20MHz)

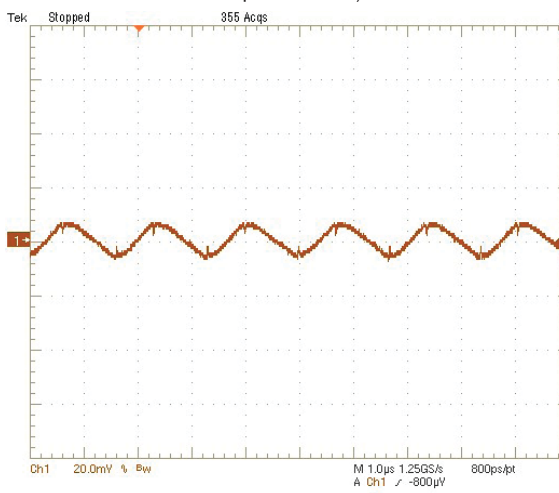

Step Load Transient Response (Vin=5.0V, Vout=1.2V, Cload=94µF, Iout=6A to 12A) Trace 1=Vout, 200 mV/div, Trace 4=Iout, 10A/div.

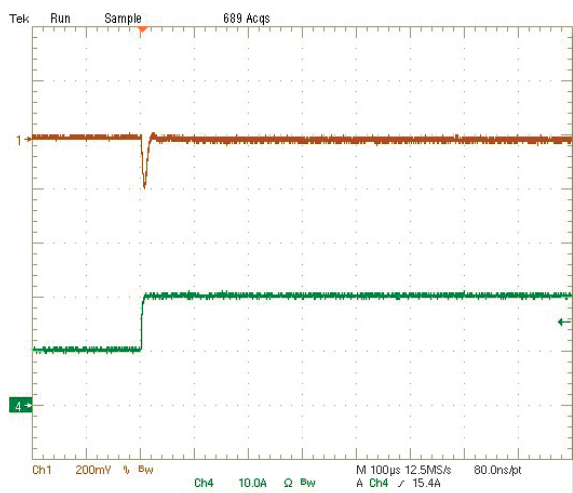

Step Load Transient Response (Vin=5.0V, Vout=1.2V, Cload=94µF, Iout=20A to 10A) Trace 1=Vout, 200 mV/div, Trace 4=Iout, 10A/div.

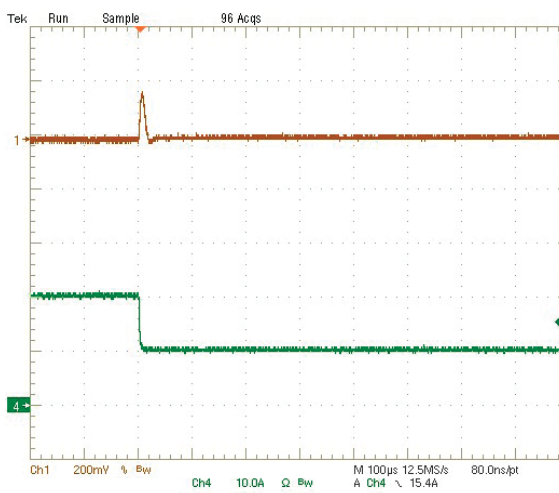

OKL2-T/20-W5 PERFORMANCE DATA AND OSCILLOGRAMS

Efficiency vs. Line Voltage and Load Current @Ta = +25 °C (Vout = 1.2V)

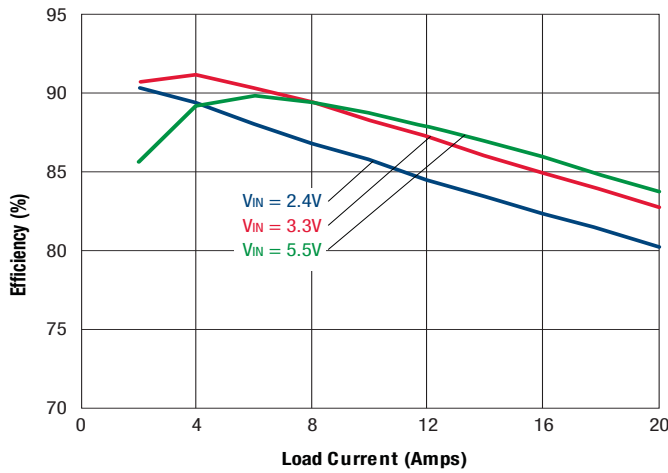

Maximum Current Temperature Derating at Sea Level (Vin=5V, Vout=1.2V)

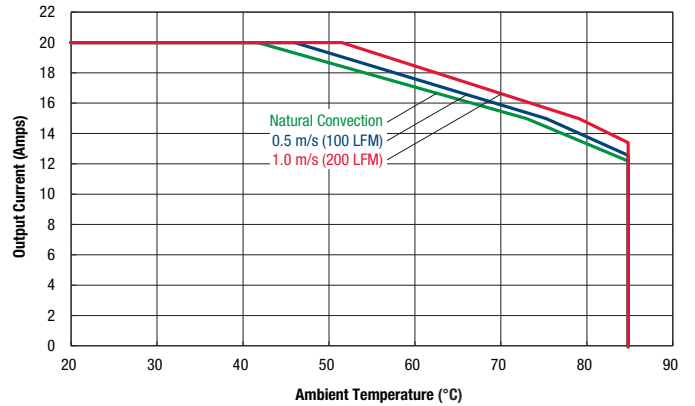

On/Off Enable Delay (Vin=12V, Vout=1.2V, Iout=20A, Cload=94µF) Trace2=Enable, Trace1=Vout

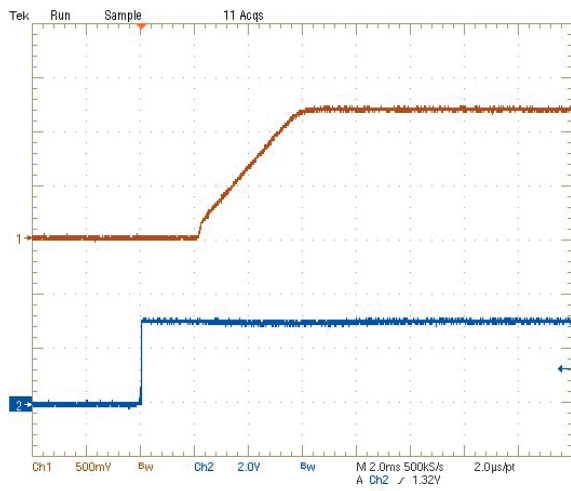

Output Ripple and Noise (Vin=12V, Vout=1.2V, Iout=20A, Cload=94µF, ScopeBW=20MHz)

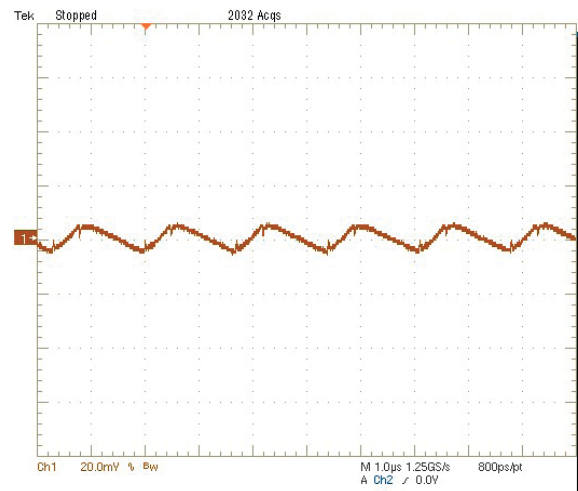

Step Load Transient Response (Vin=5V, Vout=1.2V, Cload=94µF, Iout=6A to 12A) Trace 1=Vout, 200 mV/div, Trace 4=Iout, 10A/div.

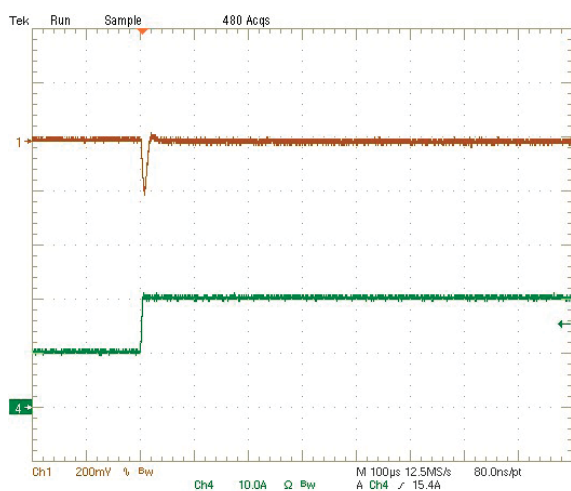

Step Load Transient Response (Vin=5V, Vout=1.2V, Cload=94µF, Iout=20A to 10A) Trace 1=Vout, 200 mV/div, Trace 4=Iout, 10A/div.

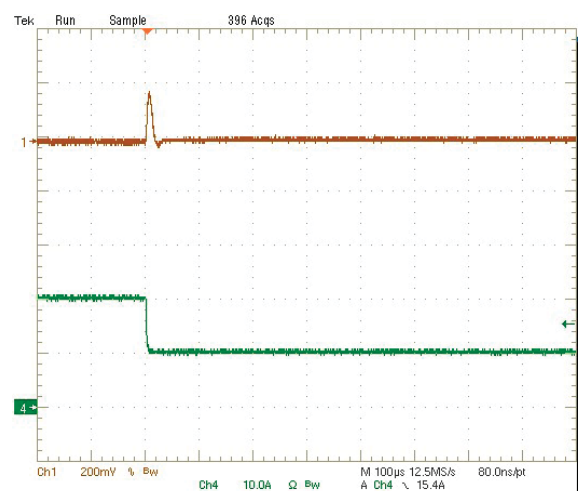

OKL2-T/20-W5 PERFORMANCE DATA AND OSCILLOGRAMS

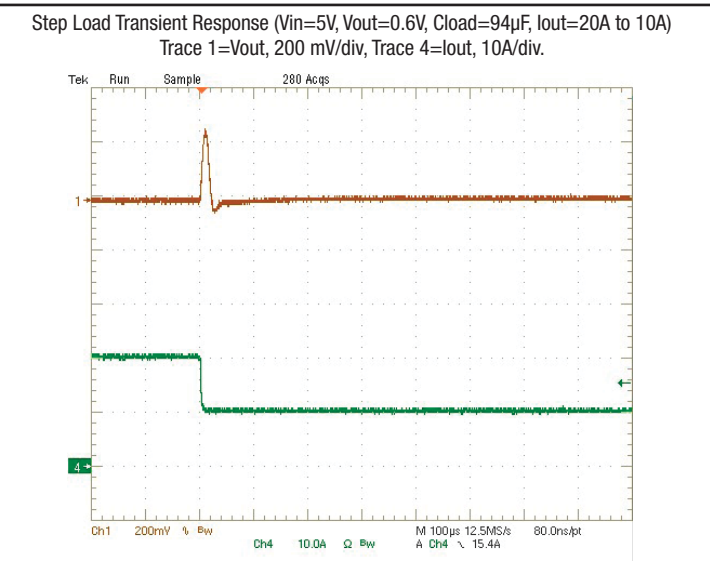
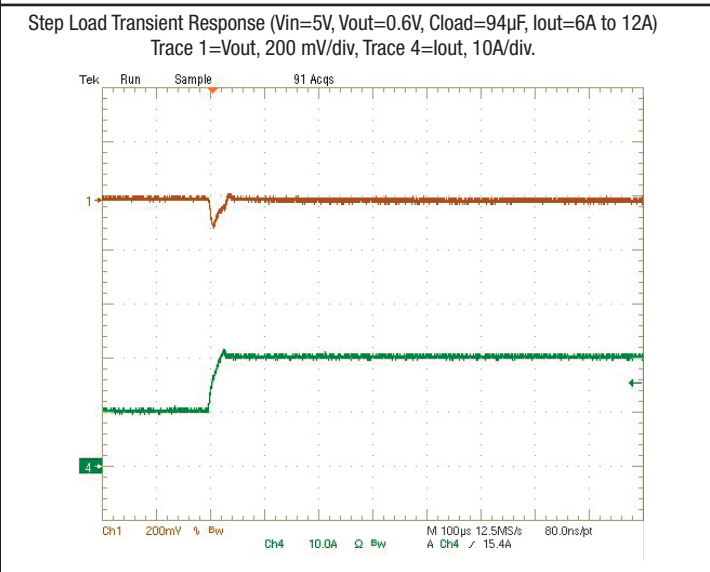
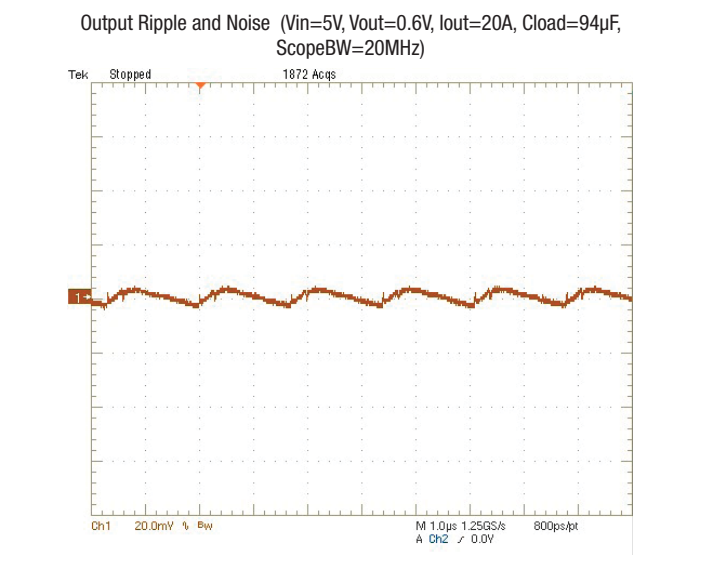
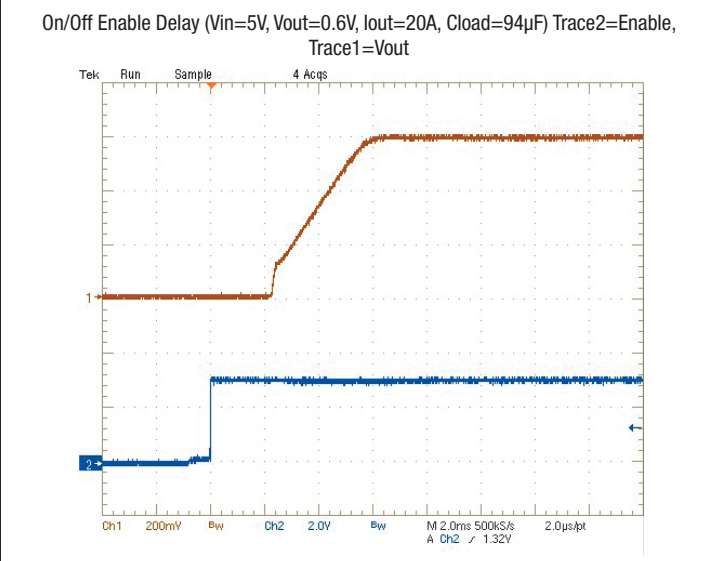
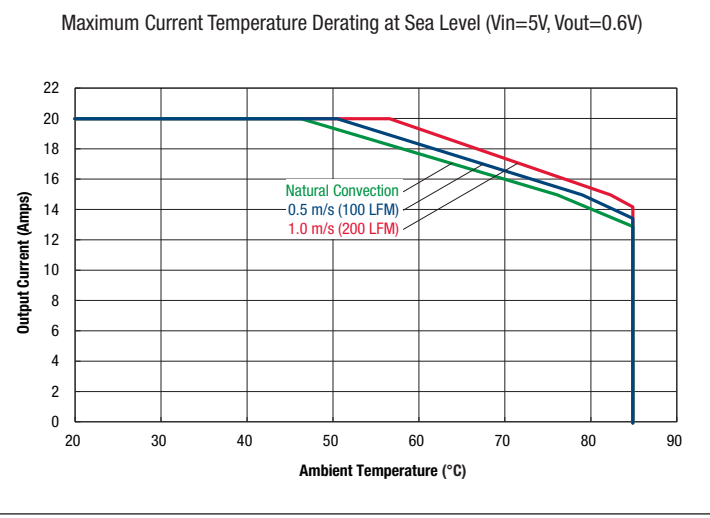
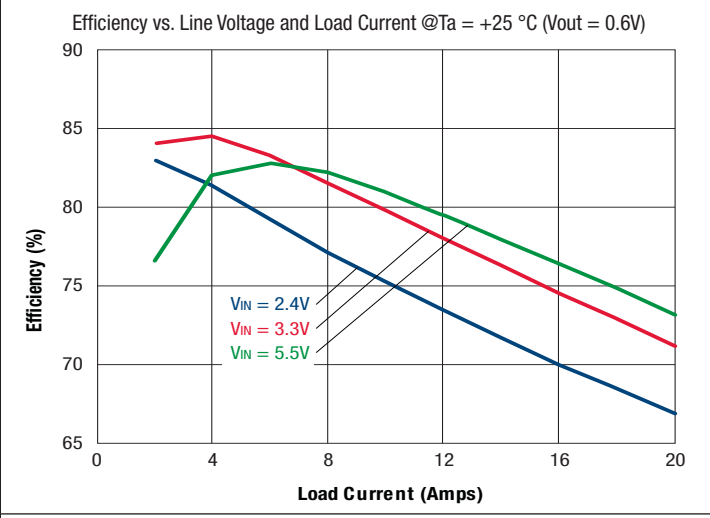

MECHANICAL SPECIFICATIONS

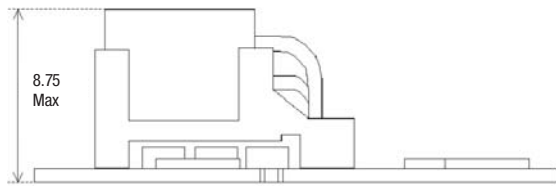

SIDE VIEW

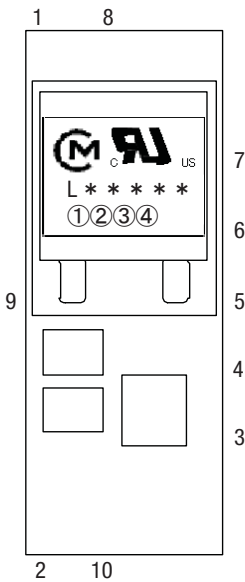

TOP VIEW

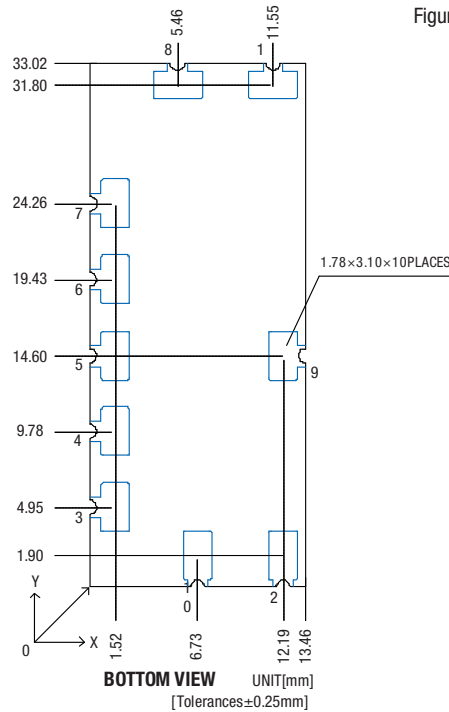
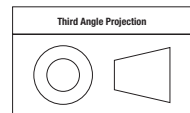

Figure 3. OKL2-T/20-W5 Mechanical Outline

INPUT/OUTPUT CONNECTIONS	
Pin	Function
1	On/Off Control*
2	VIN
3	Sequence/Tracking
4	Ground
5	VOUT
6	Trim
7	+Sense (VOUT)
8	-Sense (Ground)
9	N.C.
10	N.C.

*The Remote On/Off can be provided with either positive (P suffix) or negative (N suffix) logic.

Dimensions are in inches (mm shown for ref. only).



Tolerances (unless otherwise specified):
.XX ± 0.02 (0.5)
.XXX ± 0.010 (0.25)
Angles ± 1°

Components are shown for reference only.

RECOMMENDED LAYOUT

TOP VIEW

Unit:mm

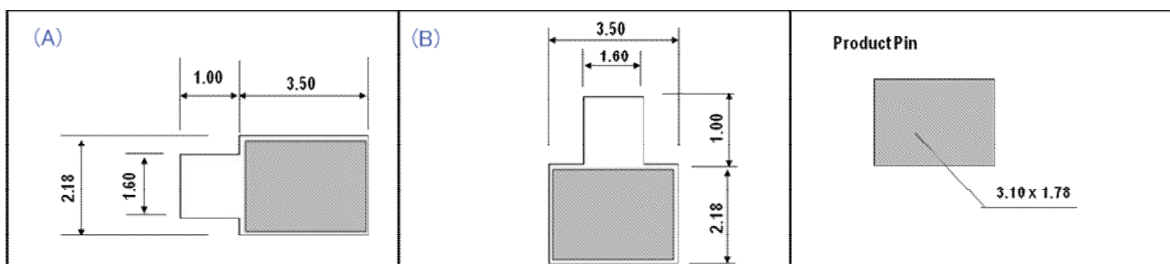
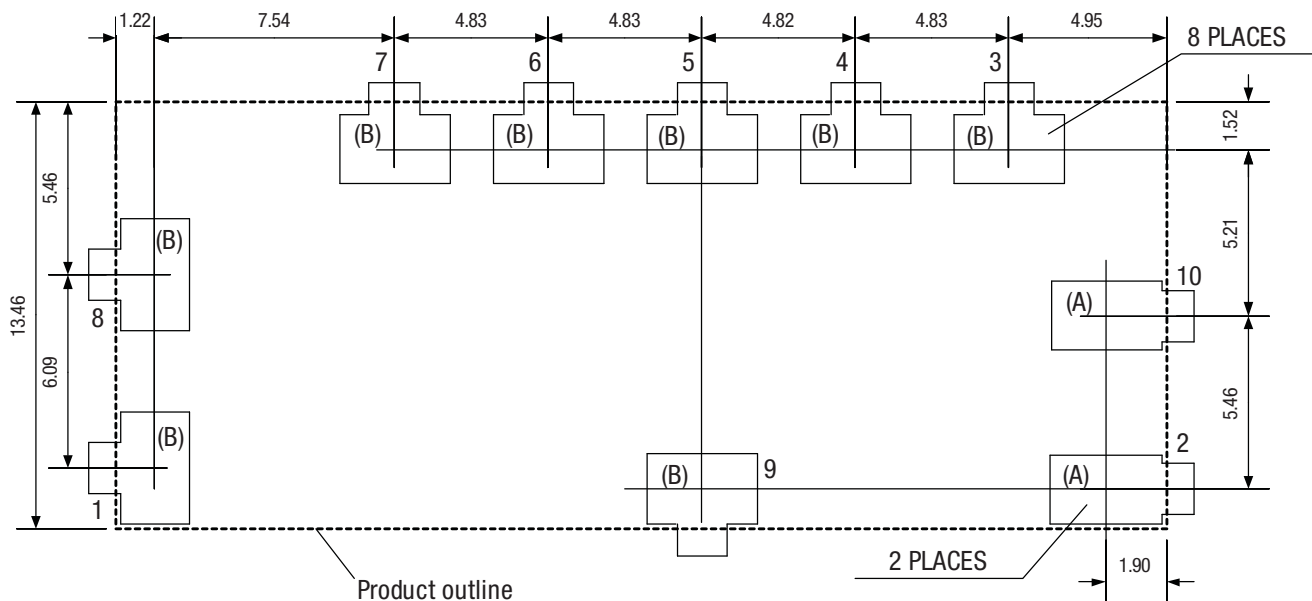

SOLDER PAD NOTES:

[1] To avoid incorrect contacts with exposed vias and plated through holes on the bottom of the converter, do not have any exposed copper in the center area of the host PC board (see drawing). Except for connections to the pads, keep all external circuits away from the board edges.

[2] Do not connect any additional components between the Trim pin and Vout or between the Trim and Sense pins. Use only the specified connections.

Dimensions are in inches (mm shown for ref. only).

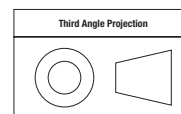

Tolerances (unless otherwise specified):
.XX ± 0.02 (0.5)
.XXX ± 0.010 (0.25)
Angles ± 1°

Components are shown for reference only.

TAPE AND REEL INFORMATION (MSL RATING 2)

Tape Detail

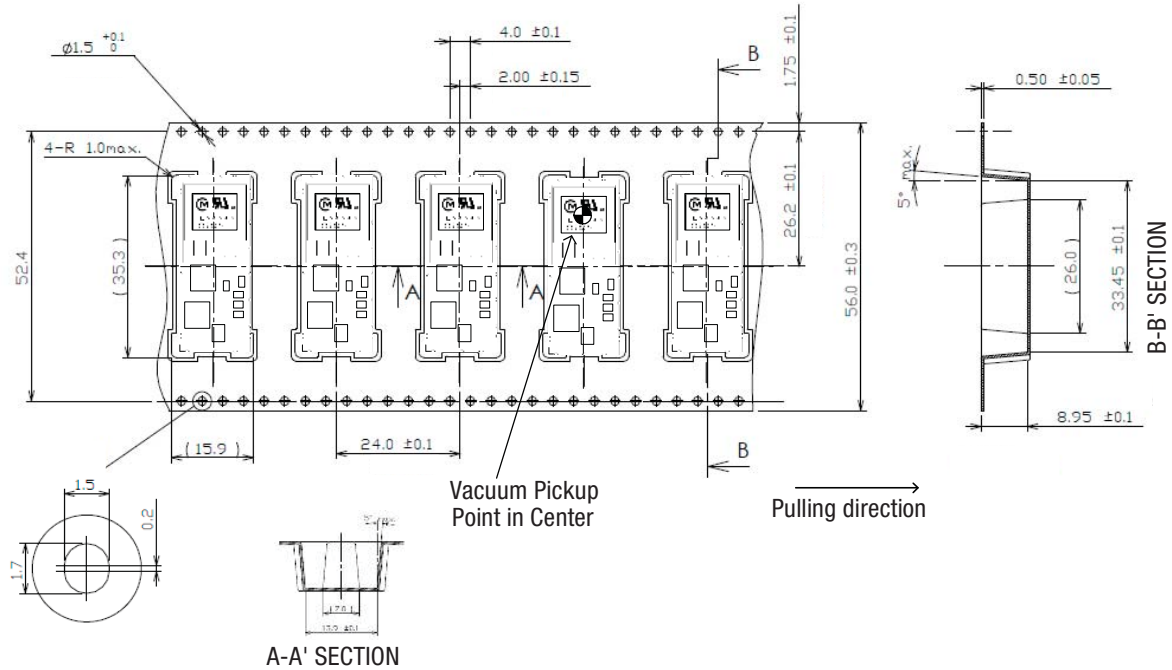

Reel Detail

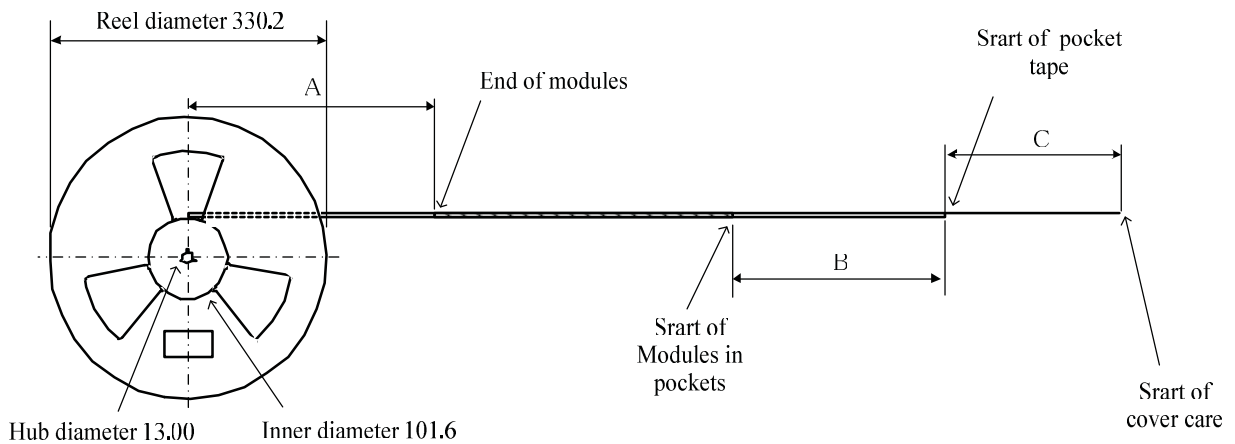

Key	Description	Length (mm)
A	Tape trailer (no modules)	240±40
B	Pocket tape length before modules	240±60
C	Cover tape length before pocket tape	240±40

TECHNICAL NOTES

Output Voltage Adjustment

The output voltage may be adjusted over a limited range by connecting an external trim resistor (Rtrim) between the Trim pin and Ground. The Rtrim resistor must be a 1/10 Watt precision metal film type, ±0.5% accuracy or better with low temperature coefficient, ±100 ppm/degC. or better. Mount the resistor close to the converter with very short leads or use a surface mount trim resistor.

In the table below, the calculated resistance is given. Do not exceed the specified limits of the output voltage or the converter's maximum power rating when applying these resistors. Also, avoid high noise at the Trim input. However, to prevent instability, you should never connect any capacitors to Trim.

OKL2-T/20-W5

Output Voltage	Calculated Rtrim (KΩ)
3.3 V	0.444
2.5 V	0.63
1.8 V	1.00
1.5 V	1.33
1.2 V	2.00
1.0 V	3.00
0.6 V	∞ (open)

Resistor Trim Equation, OKL2-T/20-W5 models:

$$R_{\text{TRIM}} (\text{k}\Omega) = \frac{1.2}{V_{\text{OUT}} - 0.6}$$

Input Fusing

Certain applications and/or safety agencies may require fuses at the inputs of power conversion components. Fuses should also be used when there is the possibility of sustained input voltage reversal which is not current limited. For greatest safety, we recommend a fast blow fuse installed in the ungrounded input supply line.

The installer must observe all relevant safety standards and regulations.

For safety agency approvals, install the converter in compliance with the end-user safety standard.

Input Under-Voltage Shutdown and Start-Up Threshold

Under normal start-up conditions, converters will not begin to regulate properly until the ramping-up input voltage exceeds and remains at the Start-Up Threshold Voltage (see Specifications). Once operating, converters will not turn off until the input voltage drops below the Under-Voltage Shutdown Limit. Subsequent restart will not occur until the input voltage rises again above the Start-Up Threshold. This built-in hysteresis prevents any unstable on/off operation at a single input voltage.

Users should be aware however of input sources near the Under-Voltage Shutdown whose voltage decays as input current is consumed (such as

capacitor inputs), the converter shuts off and then restarts as the external capacitor recharges. Such situations could oscillate. To prevent this, make sure the operating input voltage is well above the UV Shutdown voltage AT ALL TIMES.

Start-Up Time

Assuming that the output current is set at the rated maximum, the Vin to Vout Start-Up Time (see Specifications) is the time interval between the point when the ramping input voltage crosses the Start-Up Threshold and the fully loaded regulated output voltage enters and remains within its specified accuracy band. Actual measured times will vary with input source impedance, external input capacitance, input voltage slew rate and final value of the input voltage as it appears at the converter.

These converters include a soft start circuit to moderate the duty cycle of its PWM controller at power up, thereby limiting the input inrush current. The On/Off Remote Control interval from On command to Vout regulated

assumes that the converter already has its input voltage stabilized above the Start-Up Threshold before the On command. The interval is measured from the On command until the output enters and remains within its specified accuracy band. The specification assumes that the output is fully loaded at maximum rated current. Similar conditions apply to the On to Vout regulated specification such as external load capacitance and soft start circuitry.

Recommended Input Filtering

The user must assure that the input source has low AC impedance to provide dynamic stability and that the input supply has little or no inductive content, including long distributed wiring to a remote power supply. The converter will operate with no additional external capacitance if these conditions are met.

For best performance, we recommend installing a low-ESR capacitor immediately adjacent to the converter's input terminals. The capacitor should be a ceramic type such as the Murata GRM32 series or a polymer type. Initial suggested capacitor values are 44 µF, rated at twice the expected maximum input voltage. Make sure that the input terminals do not go below the under voltage shutdown voltage at all times. More input bulk capacitance may be added in parallel (either electrolytic or tantalum) if needed.

Recommended Output Filtering

The converter will achieve its rated output ripple and noise with no additional external capacitor. However, the user may install more external output capacitance to reduce the ripple even further or for improved dynamic response. Again, use low-ESR ceramic (Murata GRM32 series) or polymer capacitors. Initial values of 94 µF may be tried, either single or multiple capacitors in parallel. Mount these close to the converter. Measure the output ripple under your load conditions.

Use only as much capacitance as required to achieve your ripple and noise objectives. Excessive capacitance can make step load recovery sluggish or possibly introduce instability. Do not exceed the maximum rated output capacitance listed in the specifications.

Input Ripple Current and Output Noise

All models in this converter series are tested and specified for input reflected ripple current and output noise using designated external input/output components, circuits and layout as shown in the figures below. The Cbus and Lbus components simulate a typical DC voltage bus. Please note that the values of Cin, Lbus and Cbus will vary according to the specific converter model.

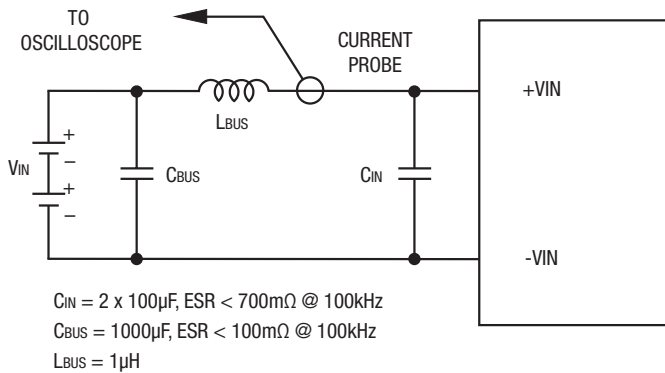

Figure 4. Measuring Input Ripple Current

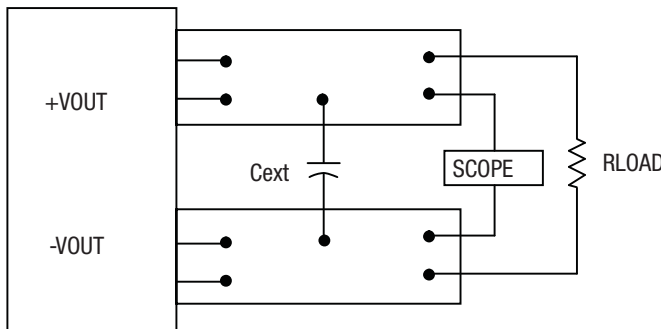

Figure 5. Measuring Output Ripple and Noise (PARD)

The capacitor Cext value is found on the electrical data page.

Minimum Output Loading Requirements

All models regulate within specification and are stable under no load to full load conditions. Operation under no load might, however, slightly increase output ripple and noise.

Thermal Shutdown

To prevent many over temperature problems and damage, these converters include thermal shutdown circuitry. If environmental conditions cause the temperature of the DC-DCs to rise above the Operating Temperature Range up to the shutdown temperature, an on-board electronic temperature sensor will power down the unit. When the temperature decreases below the turn-on threshold, the converter will automatically restart.

CAUTION: If you operate too close to the thermal limits, the converter may shut down suddenly without warning. Be sure to thoroughly test your application to avoid unplanned thermal shutdown.

Temperature Derating Curves

The graphs in this data sheet illustrate typical operation under a variety of conditions. The derating curves show the maximum continuous ambient air temperature and decreasing maximum output current which is acceptable under increasing forced airflow measured in Linear Feet per Minute (“LFM”). Note that these are AVERAGE measurements. The converter will accept brief increases in current or reduced airflow as long as the average is not exceeded.

Note that the temperatures are of the ambient airflow, not the converter itself which is obviously running at higher temperature than the outside air. Also note that very low flow rates (below about 25 LFM) are similar to “natural convection”, that is, not using fan-forced airflow. Murata makes Characterization measurements in a closed cycle wind tunnel with calibrated airflow. We use both thermocouples and an infrared camera system to observe thermal performance.

CAUTION: These graphs are all collected at slightly above Sea Level altitude. Be sure to reduce the derating for higher density altitude.

Output Voltage Sequencing

The OKL modules include a sequencing feature that enables users to implement various types of output voltage sequencing in their applications. This is accomplished via an additional sequencing pin. When not using the sequencing feature, either tie the sequence pin to Vin or leave it unconnected.

When an analog voltage is applied to the sequence pin, the output voltage tracks this voltage until the output reaches the set-point voltage. The final value of the sequence voltage must be set higher than the set-point voltage of the module. The output voltage follows the voltage on the sequence pin on a one-to-one volt basis. By connecting multiple modules together, multiple modules can track their output voltages to the voltage applied on the sequence pin.

For proper voltage sequencing, first, input voltage is applied to the module. The On/Off pin of the module is left unconnected (or tied to GND for negative logic modules or tied to Vin for positive logic modules) so that the module is ON by default. After applying input voltage to the module, a minimum 10msec delay is required before applying voltage on the sequence pin. During this time, a voltage of 50mV (± 20 mV) is maintained on the sequence pin. This delay gives the module enough time to complete its internal powerup soft-start cycle. During the delay time, the sequence pin should be held close to ground (nominally 50mV ± 20 mV). This is required to keep the internal opamp out of saturation thus preventing output overshoot during the start of the sequencing ramp. By selecting resistor R1 according to the following equation

$$R1 = \frac{23500}{V_{in} - 0.05} \text{ ohms,}$$

the voltage at the sequencing pin will be 50mV when the sequencing signal is at zero. See figure 6 for R1 connection for the sequencing signal to the SEQ pin.

Output Current Limiting

Current limiting inception is defined as the point at which full power falls below the rated tolerance. See the Performance/Functional Specifications. Note particularly that the output current may briefly rise above its rated value in normal operation as long as the average output power is not exceeded. This enhances reliability and continued operation of your application. If the output current is too high, the converter will enter the short circuit condition.

Output Short Circuit Condition

When a converter is in current-limit mode, the output voltage will drop as the output current demand increases. If the output voltage drops too low (approximately 98% of nominal output voltage for most models), the magnetically coupled voltage used to develop primary side voltages will also drop, thereby shutting down the PWM controller. Following a time-out period, the PWM will restart, causing the output voltage to begin ramping up to its appropriate value. If the short-circuit condition persists, another shutdown cycle will initiate. This rapid on/off cycling is called “hiccup”

mode”. The hiccup cycling reduces the average output current, thereby preventing excessive internal temperatures and/or component damage. A short circuit can be tolerated indefinitely.

The “hiccup” system differs from older latching short circuit systems because you do not have to power down the converter to make it restart. The system will automatically restore operation as soon as the short circuit condition is removed.

Remote On/Off Control

The OKL Series power modules can be specified with either a positive or negative logic type. See Figures 6 and 7 for On/Off circuit control. In the positive logic on/off option the unit turns on during a logic high on the On/Off pin and turns off during a logic low. In a negative logic on/off option, the unit turns off during logic high and on during logic low. The On/Off signal should always be reference to ground. For positive or negative option, leaving then On/Off pin disconnected will turn the unit on when input voltage is present.

Positive—Units are enabled when the on/off pin is left open or is pulled high to +Vin. The On/Off circuit control is shown in figure 6. When the external transistor Q1 is in the off state, the internal PWM enable pin is pull high causing the unit to turn on. When Q1 is turn on, the On/Off pin is pulled low and the units is off. Rp should be around 3KΩ.

Negative—Units are enabled when the ON/Off is open or brought to within a low voltage (see specifications) with respect to –Vin. The unit is off when the ON/Off is pulled high with respect to –Vin (see specifications). The On/Off circuitry is shown in figure 7. The On/Off pin should be pulled high with an external pull-up resistor (3KΩ). When Q1 is in the off state, the On/Off pin is pulled high, transistor Q3 is turn on and the unit is off. To turn on the unit, Q1 is turn on, pulling the On/Off pin low and turning Q3 off resulting on the unit being on.

Dynamic control of the On/Off function should be able to sink the specified signal current when brought low and withstand appropriate voltage when brought high. Be aware too that there is a finite time in milliseconds (see specifications) between the time of On/Off Control activation and stable, regulated output. This time will vary slightly with output load type and current and input conditions.

Output Capacitive Load

These converters do not require external capacitance added to achieve rated specifications. Users should only consider adding capacitance to reduce switching noise and/or to handle spike current load steps. Install only enough capacitance to achieve noise objectives. Excess external capacitance may cause regulation problems, degraded transient response and possible oscillation or instability.

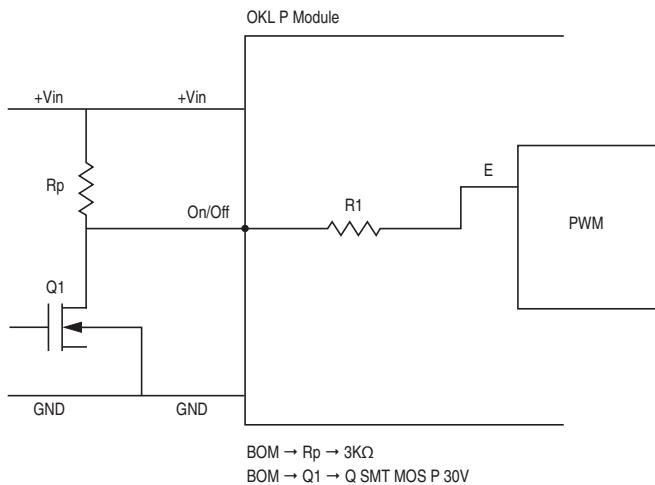

Figure 6. On/Off Circuit Control for Using Positive On/Off Logic

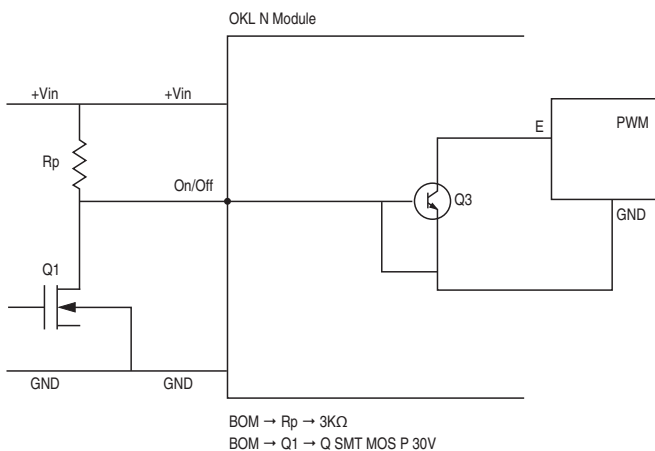

Figure 7. On/Off Circuit Control for Using Negative On/Off Logic

Voltage Range Graph

Please observe the limits below for voltage input and output ranges. These limits apply at all output currents (Ta = 25°C).

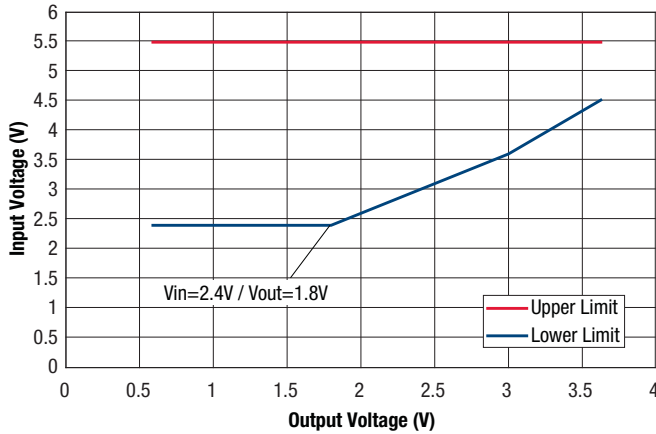

Figure 8. Voltage Range Graph

Soldering Guidelines

Murata Power Solutions recommends the specifications below when installing these converters. These specifications vary depending on the solder type. Exceeding these specifications may cause damage to the product. Your production environment may differ therefore please thoroughly review these guidelines with your process engineers.

Reflow Solder Operations for surface-mount products (SMT)	
For Sn/Ag/Cu based solders:	
Preheat Temperature	Less than 1 °C. per second
Time over Liquidus	45 to 75 seconds
Maximum Peak Temperature	260 °C.
Cooling Rate	Less than 3 °C. per second
For Sn/Pb based solders:	
Preheat Temperature	Less than 1 °C. per second
Time over Liquidus	60 to 75 seconds
Maximum Peak Temperature	235 °C.
Cooling Rate	Less than 3 °C. per second

Recommended Lead-free Solder Reflow Profile

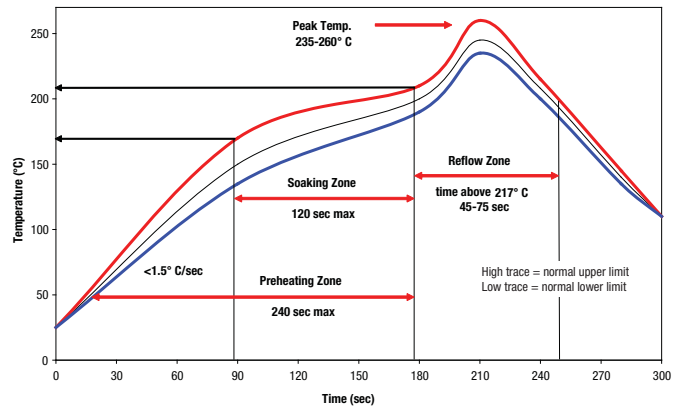

CAUTION: Do not reflow the DC-DC converter as follows, because the DC-DC converter may fall from the substrate during reflowing.

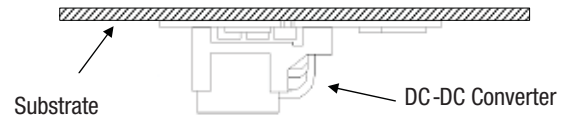

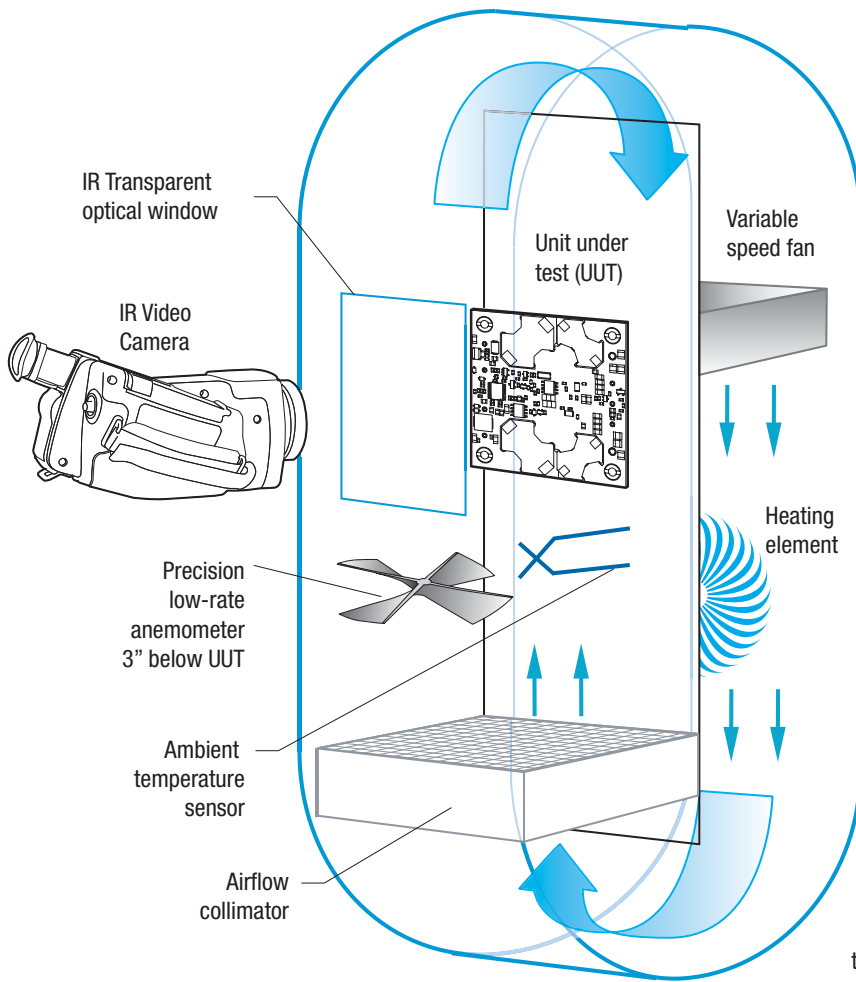

Figure 9. Vertical Wind Tunnel

Vertical Wind Tunnel

Murata Power Solutions employs a computer controlled custom-designed closed loop vertical wind tunnel, infrared video camera system, and test instrumentation for accurate airflow and heat dissipation analysis of power products. The system includes a precision low flow-rate anemometer, variable speed fan, power supply input and load controls, temperature gauges, and adjustable heating element.

The IR camera monitors the thermal performance of the Unit Under Test (UUT) under static steady-state conditions. A special optical port is used which is transparent to infrared wavelengths.

Both through-hole and surface mount converters are soldered down to a 10" x 10" host carrier board for realistic heat absorption and spreading. Both longitudinal and transverse airflow studies are possible by rotation of this carrier board since there are often significant differences in the heat dissipation in the two airflow directions. The combination of adjustable airflow, adjustable ambient heat, and adjustable Input/Output currents and voltages mean that a very wide range of measurement conditions can be studied.

The collimator reduces the amount of turbulence adjacent to the UUT by minimizing airflow turbulence. Such turbulence influences the effective heat transfer characteristics and gives false readings. Excess turbulence removes more heat from some surfaces and less heat from others, possibly causing uneven overheating.

Both sides of the UUT are studied since there are different thermal gradients on each side. The adjustable heating element and fan, built-in temperature gauges, and no-contact IR camera mean that power supplies are tested in real-world conditions.





Компания «ЭлектроПласт» предлагает заключение долгосрочных отношений при поставках импортных электронных компонентов на взаимовыгодных условиях!

Наши преимущества:

- Оперативные поставки широкого спектра электронных компонентов отечественного и импортного производства напрямую от производителей и с крупнейших мировых складов;
- Поставка более 17-ти миллионов наименований электронных компонентов;
- Поставка сложных, дефицитных, либо снятых с производства позиций;
- Оперативные сроки поставки под заказ (от 5 рабочих дней);
- Экспресс доставка в любую точку России;
- Техническая поддержка проекта, помощь в подборе аналогов, поставка прототипов;
- Система менеджмента качества сертифицирована по Международному стандарту ISO 9001;
- Лицензия ФСБ на осуществление работ с использованием сведений, составляющих государственную тайну;
- Поставка специализированных компонентов (Xilinx, Altera, Analog Devices, Intersil, Interpoint, Microsemi, Aeroflex, Peregrine, Syfer, Eurofarad, Texas Instrument, Miteq, Cobham, E2V, MA-COM, Hittite, Mini-Circuits, General Dynamics и др.);

Помимо этого, одним из направлений компании «ЭлектроПласт» является направление «Источники питания». Мы предлагаем Вам помощь Конструкторского отдела:

- Подбор оптимального решения, техническое обоснование при выборе компонента;
- Подбор аналогов;
- Консультации по применению компонента;
- Поставка образцов и прототипов;
- Техническая поддержка проекта;
- Защита от снятия компонента с производства.



Как с нами связаться

Телефон: 8 (812) 309 58 32 (многоканальный)

Факс: 8 (812) 320-02-42

Электронная почта: org@eplast1.ru

Адрес: 198099, г. Санкт-Петербург, ул. Калинина, дом 2, корпус 4, литера А.