

KAI-47051

8856 (H) x 5280 (V) Interline CCD Image Sensor

Description

The KAI-47051 Image Sensor is a 47-megapixel CCD designed for the most demanding inspection and surveillance applications. Based on an advanced 5.5-micron Interline Transfer CCD Platform, the sensor features broad dynamic range and excellent imaging performance and uniformity. Full resolution readout of up to 7 frames per second is enabled through a multi-tap output architecture, and a vertical overflow drain structure suppresses image blooming and enables electronic shuttering for precise exposure control.

The sensor is electrically similar to other devices in the 5.5-micron Interline Transfer CCD Platform, allowing cameras designed for that platform to be leveraged in support of this high-resolution device.

Table 1. GENERAL SPECIFICATIONS

Parameter	Typical Value
Architecture	Interline CCD, Progressive Scan
Total Number of Pixels	8880 (H) × 5392 (V)
Number of Effective Pixels	8880 (H) × 5304 (V)
Number of Active Pixels	8856 (H) × 5280 (V)
Pixel Size	5.5 μm (H) × 5.5 μm (V)
Active Image Size	48.7 mm (H) × 29.0 mm (V) 56.7 mm (diagonal)
Aspect Ratio	5:3
Number of Outputs	8 or 16
Charge Capacity	20,000 electrons
Output Sensitivity	38 μV/e ⁻
Quantum Efficiency Pan (-AXA, -QXA) R, G, B (-FXA, -QXA)	43% 28%, 35%, 38%
Read Noise (f = 40 MHz)	10 e ⁻ rms
Dark Current Photodiode / VCCD	7 / 140 e ⁻ /s
Dark Current Doubling Temp Photodiode / VCCD	7°C / 9°C
Dynamic Range	66 dB
Charge Transfer Efficiency	0.999999
Blooming Suppression	> 300 X
Smear	-100 dB
Image Lag	< 10 electrons
Maximum Pixel Clock Speed	40 MHz
Maximum Frame Rate 8 Outputs / 16 Outputs	3.5 fps / 7.0 fps
Package Options	201 Pin PGA
Cover Glass	AR Coated, 2-Sides

NOTE: All Parameters are specified at T = 40°C unless otherwise noted.



ON Semiconductor®

www.onsemi.com



Figure 1. KAI-47051 Image Sensor

Features

- Bayer Color Pattern, Sparse Color Filter Pattern, and Monochrome Configurations
- Progressive Scan Readout
- Flexible Readout Architecture
- High Frame Rate
- High Sensitivity
- Low Noise Architecture
- Excellent Smear Performance

Applications

- Industrial Imaging and Inspection
- Aerial Surveillance
- Security

ORDERING INFORMATION

See detailed ordering and shipping information on page 2 of this data sheet.

KAI-47051

ORDERING INFORMATION

Table 2. ORDERING INFORMATION

Part Number	Description	Marking Code
KAI-47051-AXA-JD-B1	Monochrome, Special Microlens, PGA Package, Sealed Clear Cover Glass with AR Coating (Both Sides), Grade 1	KAI-47051-AXA Serial Number
KAI-47051-AXA-JD-B2	Monochrome, Special Microlens, PGA Package, Sealed Clear Cover Glass with AR Coating (Both Sides), Grade 2	
KAI-47051-AXA-JD-AE	Monochrome, Special Microlens, PGA Package, Sealed Clear Cover Glass with AR Coating (Both Sides), Engineering Grade	
KAI-47051-FXA-JD-B1	Gen2 Color (Bayer RGB), Special Microlens, PGA Package, Sealed Clear Cover Glass with AR Coating (Both Sides), Grade 1	KAI-47051-FXA Serial Number
KAI-47051-FXA-JD-B2	Gen2 Color (Bayer RGB), Special Microlens, PGA Package, Sealed Clear Cover Glass with AR Coating (Both Sides), Grade 2	
KAI-47051-FXA-JD-AE	Gen2 Color (Bayer RGB), Special Microlens, PGA Package, Sealed Clear Cover Glass with AR Coating (Both Sides), Engineering Grade	
KAI-47051-QXA-JD-B1	Gen2 Color (Sparse CFA), Special Microlens, PGA Package, Sealed Clear Cover Glass with AR Coating (Both Sides), Grade 1	KAI-47051-QXA Serial Number
KAI-47051-QXA-JD-B2	Gen2 Color (Sparse CFA), Special Microlens, PGA Package, Sealed Clear Cover Glass with AR Coating (Both Sides), Grade 2	
KAI-47051-QXA-JD-AE	Gen2 Color (Sparse CFA), Special Microlens, PGA Package, Sealed Clear Cover Glass with AR Coating (Both Sides), Engineering Grade	

See the ON Semiconductor *Device Nomenclature* document (TND310/D) for a full description of the naming convention used for image sensors. For reference documentation, including information on evaluation kits, please visit our web site at www.onsemi.com.

DEVICE DESCRIPTION

Architecture



Figure 2. Block Diagram



Figure 3. HCCD and Output Detail

Dark Pixels

There are 44 dark rows at the top and 44 dark rows at the bottom of the image sensor. The dark rows are not entirely dark and so should not be used for a dark reference level.

Dummy Pixels

Within each horizontal shift register there are 6 leading additional shift phases. These pixels are designated as dummy pixels and should not be used to determine a dark reference level.

Active Buffer Pixels

On the perimeter of the sensor there are 12 unshielded rows and columns that are classified as active buffer pixels. These pixels are light sensitive but are not tested for defects and non-uniformities.

Image Acquisition

An electronic representation of an image is formed when incident photons falling on the sensor plane create electron-hole pairs within the individual silicon photodiodes. These photoelectrons are collected locally by the formation of potential wells at each photo-site. Below photodiode saturation, the number of photoelectrons collected at each pixel is linearly dependent upon light level and exposure time and non-linearly dependent on

wavelength. When the photodiodes charge capacity is reached, excess electrons are discharged into the substrate to prevent blooming.

ESD Protection

Adherence to the power-up and power-down sequence is critical. Failure to follow the proper power-up and power-down sequences may cause damage to the sensor. See Power-Up and Power-Down Sequence section.

Bayer Color Filter Pattern



Figure 4. Bayer Color Filter Pattern

Sparse Color Filter Pattern



Figure 5. Sparse Color Filter Pattern

Physical Description

Pin Description and Device Orientation

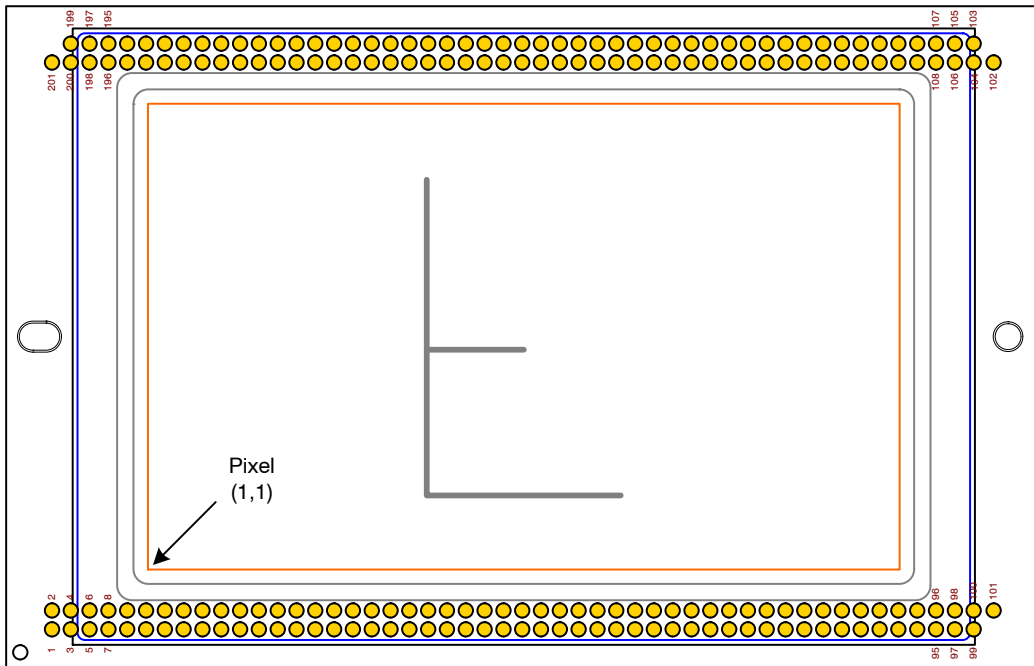

Figure 6. Package Pin Designations – Top View



Figure 7. Package Pin Designations – Bottom View

KAI-47051

Table 3. PACKAGE PIN DESCRIPTION

Pin	Name	Pin	Name	Pin	Name	Pin	Name	Pin	Name
1	N/C	41	VOUTd	81	VOUTH	121	VOUTp	161	VOUTI
2	SUB	42	VDDd	82	VDDh	122	VDDp	162	VDDI
3	ESD	43	RDd	83	RDh	123	HLODo	163	HLODk
4	GND	44	GND	84	GND	124	H1o	164	H1k
5	V3B	45	OGd	85	OGh	125	H2Lo	165	H2Lk
6	V4B	46	Rd	86	Rh	126	H2o	166	H2k
7	V1B	47	H2Ld	87	H2Lh	127	OGO	167	OGk
8	FDDB	48	H2d	88	H2h	128	Ro	168	Rk
9	V2B	49	HLODd	89	HLODh	129	RDo	169	RDk
10	FDGB	50	H1d	90	H1h	130	GND	170	GND
11	VOUTa	51	VOUTe	91	V1B	131	VOUTo	171	VOUTk
12	VDDa	52	VDDe	92	V2B	132	VDDo	172	VDDk
13	RDa	53	RDe	93	SUB	133	HLODn	173	HLODj
14	GND	54	GND	94	FDGB	134	H1n	174	H1j
15	OGa	55	OGe	95	V3B	135	H2Ln	175	H2Lj
16	Ra	56	Re	96	FDDB	136	H2n	176	H2j
17	H2La	57	H2Le	97	GND	137	OGn	177	OGj
18	H2a	58	H2e	98	V4B	138	Rn	178	Rj
19	HLODa	59	HLODe	99	TANODE	139	RDn	179	RDj
20	H1a	60	H1e	100	ESD	140	GND	180	GND
21	VOUTb	61	VOUTf	101	TCATHODE	141	VOUTn	181	VOUTj
22	VDDb	62	VDDf	102	n/c	142	VDDn	182	VDDj
23	RDb	63	RDf	103	n/c	143	HLODm	183	HLODi
24	GND	64	GND	104	ESD	144	H1m	184	H1i
25	OGb	65	OGf	105	GND	145	H2Lm	185	H2Li
26	Rb	66	Rf	106	V4T	146	H2m	186	H2i
27	H2Lb	67	H2Lf	107	V3T	147	OGm	187	OGi
28	H2b	68	H2f	108	FDDT	148	Rm	188	Ri
29	HLODb	69	HLODf	109	SUB	149	RDm	189	RDi
30	H1b	70	H1f	110	FDGT	150	GND	190	GND
31	VOUTc	71	VOUTg	111	V1T	151	VOUTm	191	VOUTi
32	VDDc	72	VDDg	112	V2T	152	VDDm	192	VDDi
33	RDc	73	RDg	113	HLODp	153	HLODi	193	V2T
34	GND	74	GND	114	H1p	154	H1l	194	FDGT
35	OGc	75	OGg	115	H2Lp	155	H2Li	195	V1T
36	Rc	76	Rg	116	H2p	156	H2l	196	FDDT
37	H2Lc	77	H2Lg	117	OGp	157	OGl	197	V3T
38	H2c	78	H2g	118	Rp	158	Rl	198	V4T
39	HLODc	79	HLODg	119	RDp	159	RDi	199	ESD
40	H1c	80	H1g	120	GND	160	GND	200	GND
								201	SUB

Table 4. PIN NAME DESCRIPTIONS

Pin Name(s)	Description
V1B, V1T	Vertical CCD Clock, Phase 1, Bottom (B) or Top (T)
V2B, V2T	Vertical CCD Clock, Phase 2, Bottom (B) or Top (T)
V3B, V3T	Vertical CCD Clock, Phase 3, Bottom (B) or Top (T)
V4B, V4T	Vertical CCD Clock, Phase 4, Bottom (B) or Top (T)
FDDB, FDDT	Fast Line Dump Drain, Bottom (B) or Top (T)
FDGB, FDGT	Fast Line Dump Gate, Bottom (B) or Top (T)
SUB	Substrate
GND	Ground
ESD	ESD Protection Disable
TANODE	Temperature Diode Anode
TCATHODE	Temperature Diode Cathode
N/C	No connect
VOU α	Video Output a to p
R α	Reset Gate a to p
RD α	Reset Drain a to p
OG α	Output Gate a to p
VDD α	Output Amplifier Supply a to p
H1 α	Horizontal CCD Clock, Phase 1, a to p
H2 α	Horizontal CCD Clock, Phase 2, a to p
H2L α	Horizontal CCD Clock, Phase 2, Last Phase, a to p
HLOD α	Horizontal CCD Overflow Drain, a to p

IMAGING PERFORMANCE

Table 5. TYPICAL OPERATION CONDITIONS

Unless otherwise noted, the Imaging Performance Specifications are measured using the following conditions.

Description	Condition	Notes
Light Source	Continuous red, green and blue LED illumination	For monochrome sensor, only green LED used.
Operation	Nominal operating voltages and timing	

Table 6. PERFORMANCE PARAMETERS (Performance parameters are by design)

Description	Symbol	Nom.	Units	Notes
Maximum Photo-response Nonlinearity	NL	2	%	2
Horizontal CCD Charge Capacity	HNe	55	ke ⁻	
Vertical CCD Charge Capacity	VNe	40	ke ⁻	
Photodiode Charge Capacity	PNe	20	ke ⁻	3
Image Lag	Lag	< 10	e ⁻	
Anti-blooming Factor	Xab	> 300X		
Vertical Smear	Smr	-100	dB	
Read Noise	n _{e-T}	10	e ⁻ rms	4
Dynamic Range	DR	66	dB	4, 5
Output Amplifier DC Offset	V _{odc}	9.4	V	
Output Amplifier Bandwidth	f _{-3db}	250	MHz	6
Output Amplifier Impedance	R _{OUT}	127	Ω	
Output Amplifier Sensitivity	ΔV/ΔN	38	μV/e ⁻	
Peak Quantum Efficiency (KAI-47051-ABA and KAI-47051-QBA Configurations)	QE _{max}	43	%	
Peak Quantum Efficiency (KAI-47051-FBA and KAI-47051-QBA Configurations)	Blue Green Red	QE _{max} 37 35 29	%	

Table 7. PERFORMANCE SPECIFICATIONS

Description	Symbol	Min.	Nom.	Max.	Units	Temperature Tested At (°C)	Notes
Dark Field Global Non-Uniformity	DSNU	-	-	5	mVpp	27, 40	
Bright Field Global Non-Uniformity		-	-	5	%rms	27, 40	1
Bright Field Global Peak to Peak Non-Uniformity	PRNU	-	-	30	%pp	27, 40	1
Horizontal CCD Charge Transfer Efficiency	HCTE	0.999995	0.999999	-			
Vertical CCD Charge Transfer Efficiency	VCTE	0.999995	0.999999	-			
Photodiode Dark Current	l _{pd}	-	7	70	e/p/s	40	
Vertical CCD Dark Current	l _{vd}	-	100	300	e/p/s	40	

1. Per color
2. Value is over the range of 10% to 90% of photodiode saturation.
3. The operating value of the substrate voltage, V_{AB}, will be marked on the shipping container for each device. The value of V_{AB} is set such that the photodiode charge capacity is 680 mV.
4. At 40 MHz
5. Uses 20LOG (PNe/ n_{e-T})
6. Assumes 5 pF load.

TYPICAL PERFORMANCE CURVES

Quantum Efficiency

Monochrome with Microlens

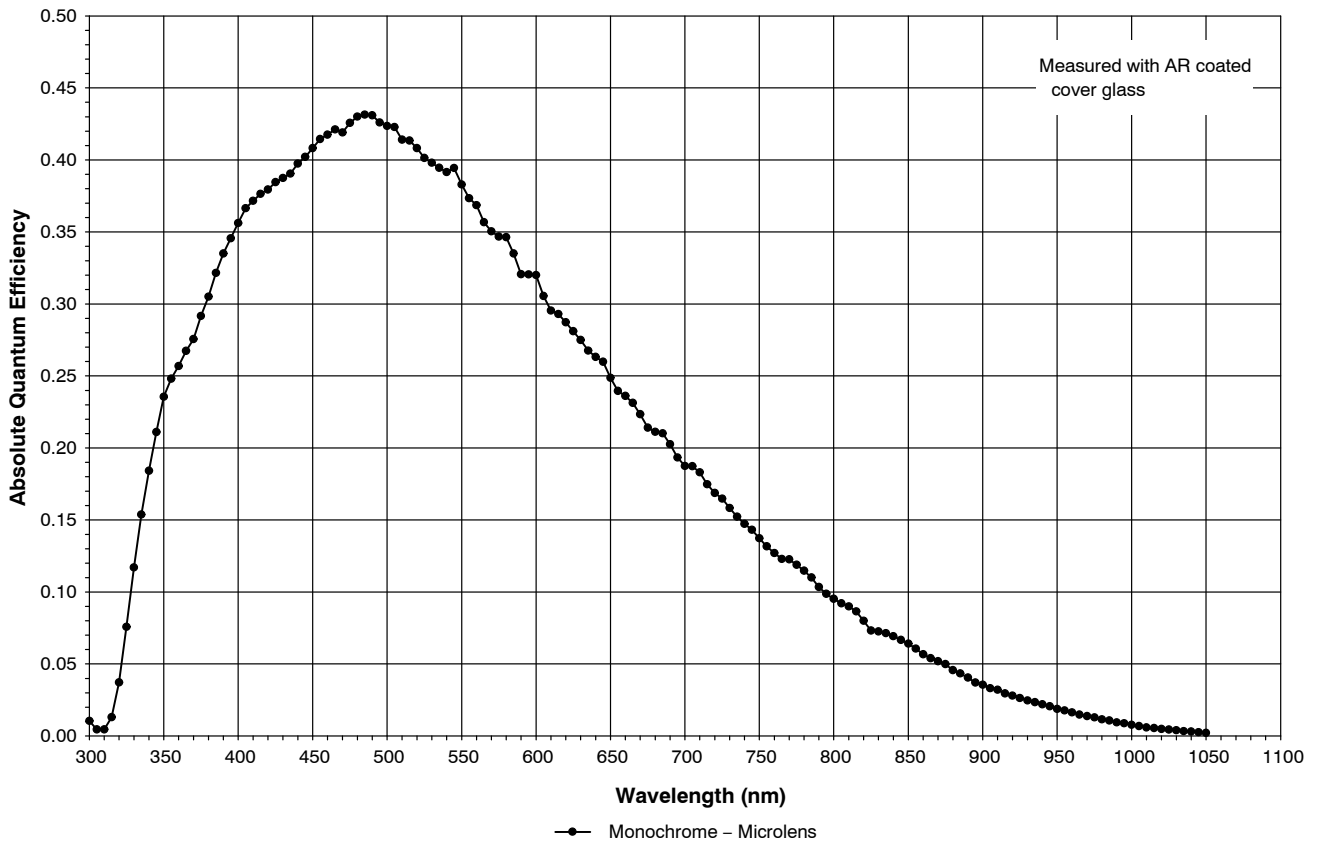

Figure 8. Monochrome with Microlens Quantum Efficiency

Color (Bayer RGB) with Microlens



Figure 9. Color (Bayer) with Microlens Quantum Efficiency

Color (Sparse CFA) with Microlens

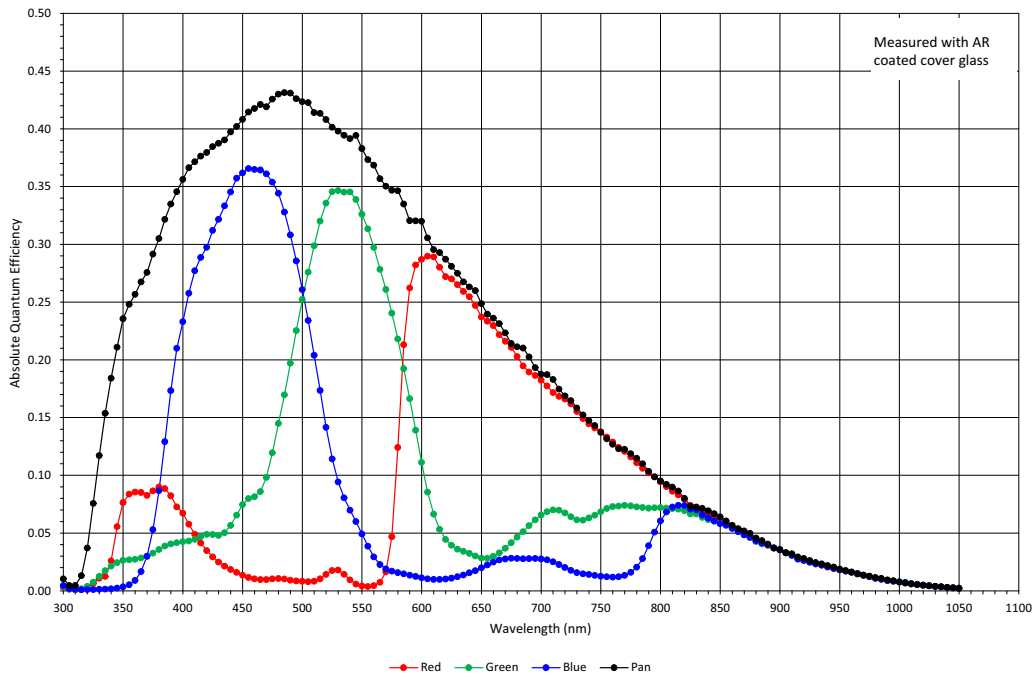

Figure 10. Color (Sparse CFA) with Microlens Quantum Efficiency

Angular Quantum Efficiency

For the curves marked “Horizontal”, the incident light angle is varied in a plane parallel to the HCCD. For the curves marked “Vertical”, the incident light angle is varied in a plane parallel to the VCCD.

Monochrome with Microlens

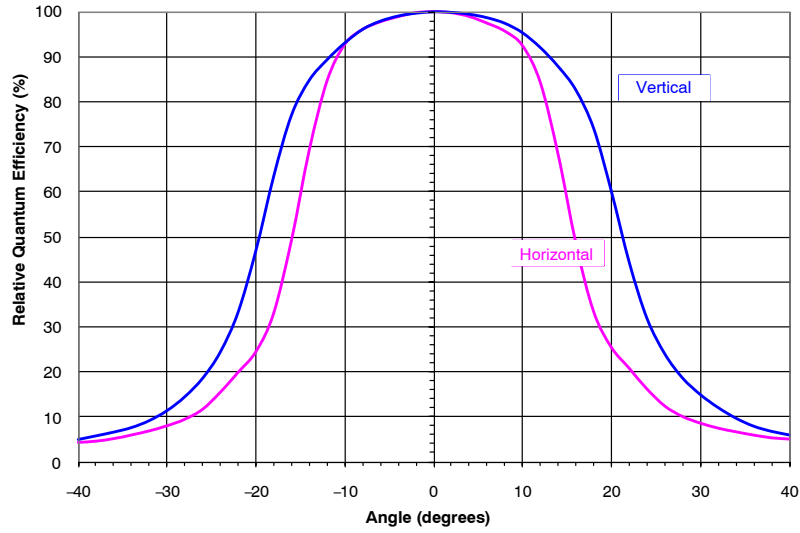

Figure 11. Monochrome with Microlens Angular Quantum Efficiency

Dark Current vs. Temperature



Figure 12. Dark Current vs. Temperature

Power-Estimated



Figure 13. Power

Frame Rates

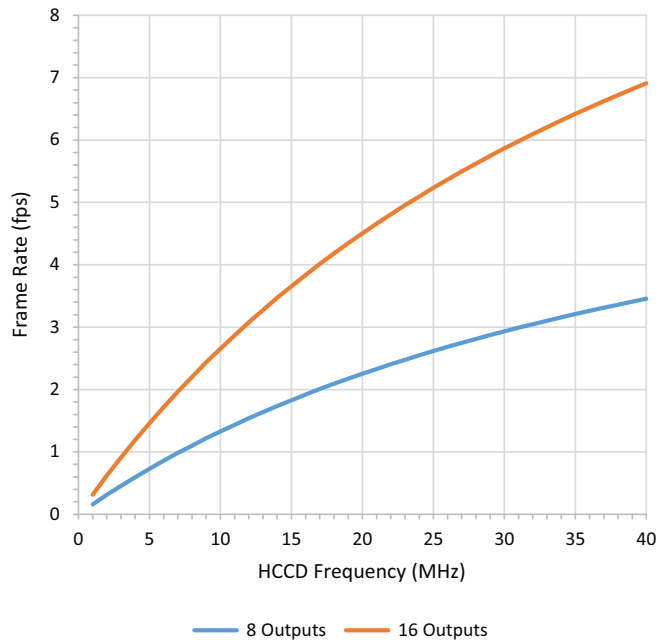

Figure 14. Frame Rates

DEFECT DEFINITIONS

Table 8. OPERATING CONDITIONS

Description	Condition	Notes
Light Source	Continuous Red, Green and/or Blue LED Illumination	For monochrome sensor, only the green LED is used.
Operation	Nominal Operating Voltages and Timing	

Table 9. OPERATING PARAMETERS

Description	8 Outputs	16 Outputs
HCCD Clock Frequency	20 MHz	20 MHz
Pixels Per Line	1146	1146
Lines Per Frame	5392	2696
Line Time	82.3 μ s	82.3 μ s
Frame Time	443.9 ms	222.0 ms

Table 10. TIMING MODES

Timing Modes	Conditions
Mode A	8 Output, no electronic shutter used. Photodiode integration time is equal to Frame Time.
Mode B	16 Output, no electronic shutter used. Photodiode integration time is equal to Frame Time.

Table 11. DEFECT DEFINITIONS

Description	Definition	Grade 1	Grade 2 (Mono)	Grade 2 (Color)
Column Defect	A group of more than 10 contiguous pixels along a single column that deviate from the neighboring columns by: <ul style="list-style-type: none"> more than 29 mV in the dark field using Timing Mode A at 40°C more than 29 mV in the dark field using Timing Mode A at 27°C more than -12% or +16% in the bright field using Timing Mode B at 27°C or 40°C 	0	7	27
Cluster Defect	A group of 2 to N contiguous defective pixels, but no more than W adjacent defects horizontally, that deviate from the neighboring pixels by: <ul style="list-style-type: none"> more than 169 mV in the dark field using Timing Mode A at 40°C more than 67 mV in the dark field using Timing Mode A at 27°C more than -12% or +16% in the bright field using Timing Mode B at 40°C or 27°C 	20 W = 4 N = 19	50 W = 5 N = 38	50 W = 5 N = 38
Major Point Defect	A single defective pixel that deviates from the neighboring pixels by: <ul style="list-style-type: none"> more than 169 mV in the dark field using Timing Mode A at 40°C more than 67 mV in the dark field using Timing Mode A at 27°C more than -12% or +16% in the bright field using Timing Mode B at 27°C or 40°C 	440	880	880
Minor Point Defect	A single defective pixel that deviates from the neighboring pixels by: <ul style="list-style-type: none"> more than 84 mV in the dark field using Timing Mode A at 40°C 	4400	8800	8800

- Bright field is define as where the average signal level of the sensor is 532 mV, with the substrate voltage set to the recommend VAB setting such that the capacity of the photodiodes is 760 mV (20,000 electrons)
- For the color device (KAI-47051-FBA or KAI-47051-QBA), a bright field defective pixel is with respect to pixels of the same color.
- Column and cluster defects are separated by no less than two (2) good pixels in any direction (excluding single pixel defects).

Defect Map

The defect map supplied with each sensor is based upon testing at an ambient (27°C) temperature. Minor point

defects are not included in the defect map. All defective pixels are reference to pixel 1, 1 in the defect maps.



Figure 15. Pixel 1, 1 Location

OPERATION

Table 12. ABSOLUTE MAXIMUM RATINGS

Description	Symbol	Minimum	Maximum	Units	Notes
Operating Temperature	T _{OP}	-50	70	°C	1
Humidity	RH	5	90	%	2
Output Bias Current	I _{OUT}	-	240	mA	3
Off-Chip Load	C _L	-	10	pF	

Stresses exceeding those listed in the Maximum Ratings table may damage the device. If any of these limits are exceeded, device functionality should not be assumed, damage may occur and reliability may be affected.

- Noise performance will degrade at higher temperatures.
- T = 25°C. Excessive humidity will degrade MTTF.
- Total for all outputs. Maximum current is -15 mA for each output. Avoid shorting output pins to ground or any low impedance source during operation. Amplifier bandwidth increases at higher current and lower load capacitance at the expense of reduced gain (sensitivity).

Table 13. ABSOLUTE MAXIMUM VOLTAGE RATINGS BETWEEN PINS AND GROUND

Description	Minimum	Maximum	Units	Notes
VDD _α , VOUT _α	-0.4	17.5	V	1
RD _α , FDD _α , HLOD _α	-0.4	15.5	V	1
V1B, V1T	ESD - 0.4	ESD + 24.0	V	
V2B, V2T, V3B, V3T, V4B, V4T	ESD - 0.4	ESD + 14.0	V	
FDGB, FDGT	ESD - 0.4	ESD + 15.0	V	
H1 _α , H2 _α , H2L _α	ESD - 0.4	ESD + 14.0	V	1
ESD	-10.0	0.0	V	
SUB	-0.4	40.0	V	

- α refers to a to p.
- Refer to Application Note *Using Interline CCD Image Sensors in High Intensity Visible Lighting Conditions*

Power-Up and Power-Down Sequence

Adherence to the power-up and power-down sequence is critical. Failure to follow the proper power-up and power-down sequences may cause damage to the sensor.



Notes:

1. Activate all other biases when ESD is stable and SUB is above 3 V.
2. Do not pulse the electronic shutter until ESD is stable.
3. VDD cannot be +15 V when SUB is 0 V.
4. The image sensor can be protected from an accidental improper ESD voltage by current limiting the SUB current to less than 10 mA. SUB and VDD must always be greater than GND. ESD must always be less than GND. Placing diodes between SUB, VDD, ESD and ground will protect the sensor from accidental overshoots of SUB, VDD and ESD during power on and power off. See the figure below.

Figure 16. Power-Up and Power-Down Sequence

The VCCD clock waveform must not have a negative overshoot more than 0.4 V below the ESD voltage.

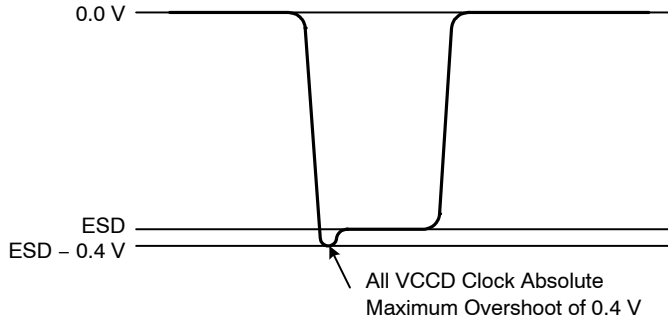

Figure 17. VCCD Clock Waveform

Example of external diode protection for SUB, VDD and ESD. α denotes a to p.

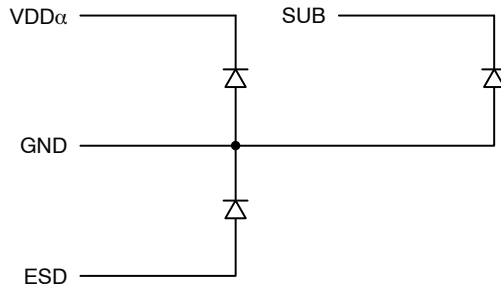

Figure 18. Example of External Diode Protection

DC Bias Operating Conditions

Table 14. DC BIAS OPERATING CONDITIONS

Description	Pins	Symbol	Min.	Nom.	Max.	Units	Max. DC Current	Notes
Reset Drain	RD α	RD	11.8	12.0	12.2	V	10 μ A	1
Fast Line Dump Drain	FDD α , FDDT	FDD	11.8	12.0	12.2	V	10 μ A	1
Horizontal Lateral Overflow Drain	HLOD α	HLOD	11.8	12.0	12.2	V	10 μ A	1
Output Gate	OG α	OG	-2.2	-2.0	-1.8	V	10 μ A	1
Output Amplifier Supply	VDD α	V _{DD}	14.5	15.0	15.5	V	11.0 mA	1, 2
Ground	GND	GND	0.0	0.0	0.0	V	-1.0 mA	
Substrate	SUB	V _{SUB}	5.0	V _{AB}	V _{DD}	V	50 μ A	3, 8
ESD Protection Disable	ESD	ESD	-9.5	-9.0	-8.8	V	50 μ A	6, 7
Output Bias Current	VOUT α	I _{OUT}	-3.0	-5.0	-10.0	mA	-	1, 4, 5

1. α denotes a to p.
2. The maximum DC current is for one output. $I_{DD} = I_{OUT} + I_{SS}$. See Figure 19.
3. The operating value of the substrate voltage, V_{AB} , will be marked on the shipping container for each device. The value of V_{AB} is set such that the photodiode charge capacity is the nominal P_{Ne} (see Specifications).
4. An output load sink must be applied to each VOUT pin to activate each output amplifier.
5. Nominal value required for 40 MHz operation per output. May be reduced for slower data rates and lower noise.
6. Adherence to the power-up and power-down sequence is critical. See Power Up and Power Down Sequence section.
7. ESD maximum value must be less than or equal to $V1_L + 0.4$ V, $V2_L + 0.4$ V, $V3_L + 0.4$ V, and $V2_L + 0.4$ V.
8. Refer to Application Note *Using Interline CCD Image Sensors in High Intensity Visible Lighting Conditions*.

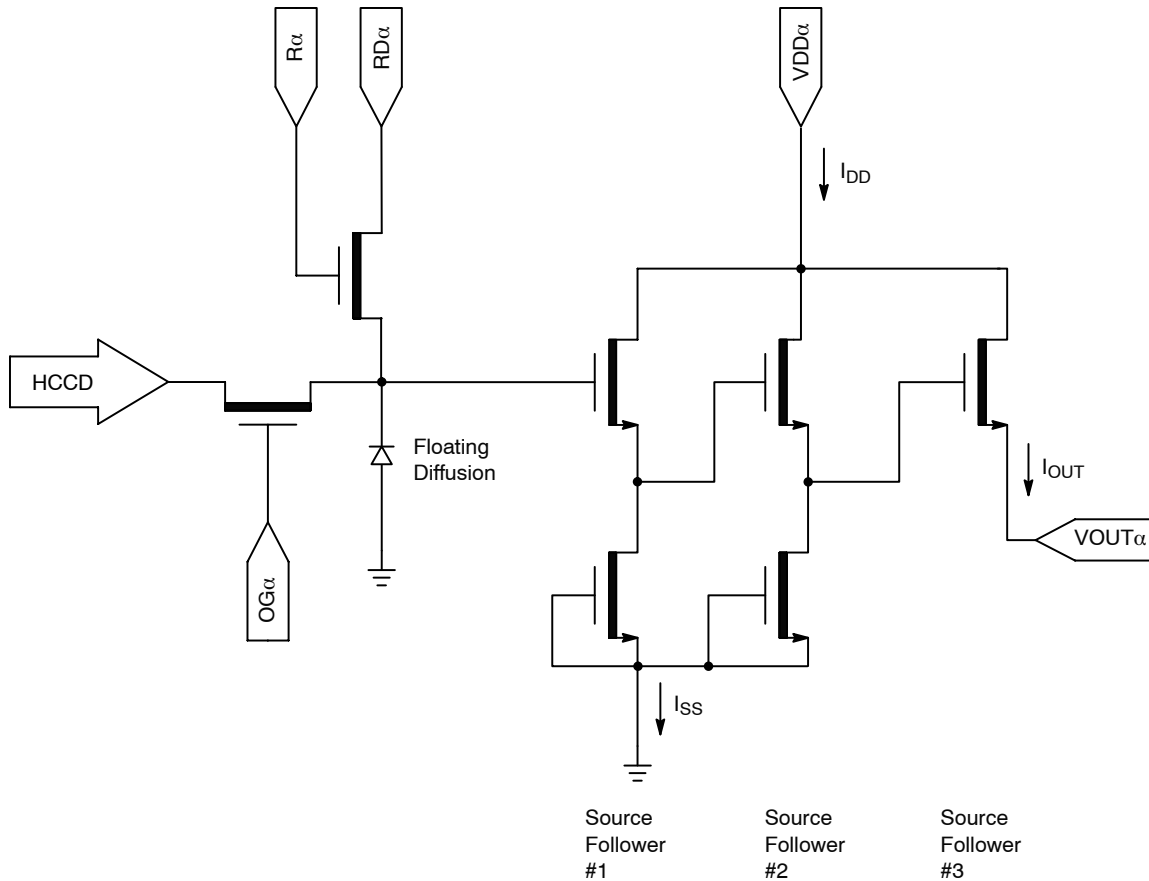

Figure 19. Output Amplifier

AC Operating Conditions

Table 15. CLOCK LEVELS

Description	Pins (Note 1)	Symbol	Level	Min.	Nom.	Max.	Units	Capacitance (Note 2)
Vertical CCD Clock, Phase 1	V1B, V1T	V1_L	Low	-8.2	-8.0	-7.8	V	290 nF (Note 6)
		V1_M	Mid	-0.2	0.0	0.2		
		V1_H	High	10.8	11.0	11.2		
Vertical CCD Clock, Phase 2	V2B, V2T	V2_L	Low	-8.2	-8.0	-7.8	V	290 nF (Note 6)
		V2_H	High	-0.2	0.0	0.2		
Vertical CCD Clock, Phase 3	V3B, V3T	V3_L	Low	-8.2	-8.0	-7.8	V	290 nF (Note 6)
		V3_H	High	-0.2	0.0	0.2		
Vertical CCD Clock, Phase 4	V4B, V4T	V4_L	Low	-8.2	-8.0	-7.8	V	290 nF (Note 6)
		V4_H	High	-0.2	0.0	0.2		
Horizontal CCD Clock, Phase 1	H1 α	H1_L	Low	-5.2 (Note 7)	-4.0	-3.8	V	1.3 nF (Note 6)
		H1_A	Amplitude	3.8	4.0	5.2 (Note 7)		
Horizontal CCD Clock, Phase 2	H2 α	H2_L	Low	-5.2 (Note 7)	-4.0	-3.8	V	1.3 nF (Note 6)
		H2_A	Amplitude	3.8	4.0	5.2 (Note 7)		
Horizontal CCD Clock, Last Phase (Note 3)	H2L α	H2L_L	Low	-5.2	-5.0	-4.8	V	30 pF (Note 6)
		H2L_A	Amplitude	4.8	5.0	5.2		
Reset Gate	R α	R_L (Note 4)	Low	-3.5	-2.0	-1.8	V	20 pF (Note 6)
		R_H	High	2.5	3.0	4.0		
Electronic Shutter (Note 5)	SUB	VES	High	29.0	30.0	40.0	V	20 nF (Note 6)
Fast Line Dump Gate	FDGB, FDGT	FDG_L	Low	-8.2	-8.0	-7.8	V	70 pF (Note 6)
		FDG_H	High	4.5	5.0	5.5		

- α denotes a to p.
- Capacitance is total for all like named pins. As an example, if all 16 H1 pins are tied together the total capacitance will be 1.3 nF.
- Use separate clock driver for improved speed performance.
- Reset low should be set to -3 V for signal levels greater than 40,000 electrons.
- Refer to Application Note *Using Interline CCD Image Sensors in High Intensity Visible Lighting Conditions*.
- Capacitance values are estimated.
- If the minimum horizontal clock low level is used (-5.0 V), then the maximum horizontal clock amplitude should be used (5 V amplitude) to create a -5.0 V to 0.0 V clock.

The figure below shows the DC bias (V_{SUB}) and AC clock (V_{ES}) applied to the SUB pin. Both the DC bias and AC clock are referenced to ground.



Figure 20. DC Bias and AC Clock Applied to the SUB Pin

Temperature Sensor

Please contact an ON Semiconductor Field Application Engineer for information regarding the operation of the temperature sensing diode.

To operate the Temperature Sensor:

- Source a negative current of $10\ \mu\text{A}$ (I_d) at the TCATHODE pin against the TANODE pin.

- Measure voltage (V_d) at TCATHODE.
- Compare V_d to a linear curve, or a look-up table to calculate the temperature.

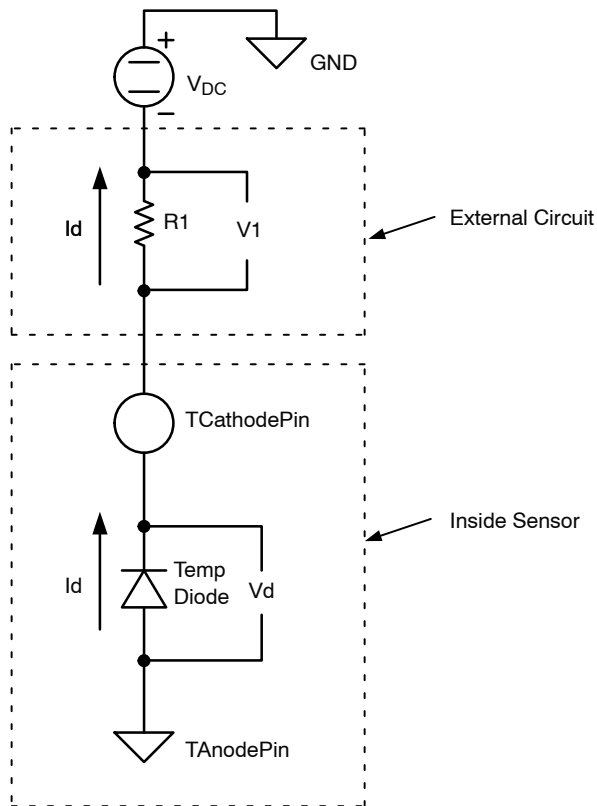

Figure 21. Temperature Sensor Connections

TIMING

Table 16. REQUIREMENTS AND CHARACTERISTICS

Description	Symbol	Min.	Nom.	Max.	Units	Notes
Photodiode Transfer	t_{PD}	4	-	-	μs	
VCCD Leading Pedestal	t_{3P}	16	-	-	μs	
VCCD Trailing Pedestal	t_{3D}	16	-	-	μs	
VCCD Transfer Delay	t_D	4	-	-	μs	
VCCD Transfer	t_V	16	-	-	μs	
VCCD Clock Cross-Over	V_{VCR}	75	-	100	%	8
VCCD Rise, Fall Times	t_{VR}, t_{VF}	5	-	10	%	8, 9
FDG Delay	t_{FDG}	2	-	-	μs	
HCCD Delay	t_{HS}	1	-	-	μs	
HCCD Transfer	t_e	25	-	-	ns	
Shutter Transfer	t_{SUB}	1	-	-	μs	
Shutter Delay	t_{HD}	1	-	-	μs	
Reset Pulse	t_R	2.5	-	-	ns	
Reset – Video Delay	t_{RV}	-	2.2	-	ns	
H2L – Video Delay	t_{HV}	-	3.1	-	ns	
Line Time	t_{LINE}	53.7	-	-	μs	
Frame Time	t_{FRAME}	144.7	-	-	ms	16 outputs
		289.4	-	-		8 outputs

8. Refer to Figure 31: VCCD Clock Rise Time, Fall Time and Edge Alignment

9. Relative to the VCCD Transfer pulse width, t_V .

Timing Flow Charts

In the timing flow charts the number of HCCD clock cycles per row, NH, and the number of VCCD clock cycles per frame, NV, are shown in the following table.

Table 17. VALUES FOR NH AND NV WHEN OPERATING THE SENSOR IN VARIOUS MODES OF RESOLUTION

	Full Resolution	
	NV	NH
16 Outputs	2696	1116
8 Outputs	5392	1116

1. The time to read out one line $t_{LINE} = \text{Line Timing} + NH / (\text{Pixel Frequency})$.
2. The time to read out one frame $t_{FRAME} = NV \cdot t_{LINE} + \text{Frame Timing}$.
3. Line Timing: See Table 19: Line Timing.
4. Frame Timing: See Table 18: Frame Timing.

No Electronic Shutter

In this case the photodiode exposure time is equal to the time to read out an image.



Figure 22. Timing Flow when Electronic Shutter is Not Used

Using the Electronic Shutter

The exposure time begins on the falling edge of the electronic shutter pulse on the SUB pin. The exposure time ends on the falling edge of the photodiode transfer (T_{pd}) of

the V1T and V1B pins. The electronic shutter timing is shown in Figure 28.

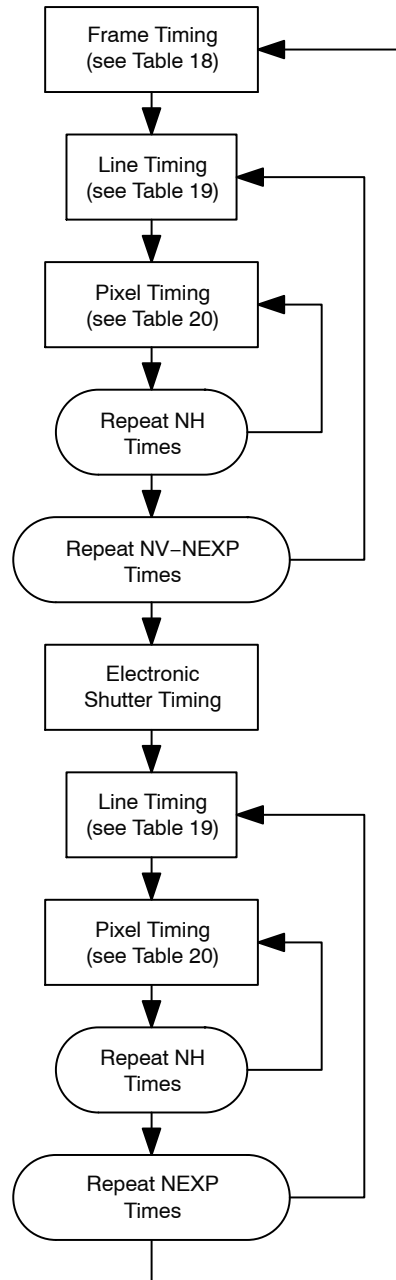

Figure 23. Timing Flow Chart using the Electronic Shutter for Exposure Control

Timing Tables

Frame Timing

This timing table is for transferring charge from the photodiodes to the VCCD. See Figure 24 and Figure 25 for frame timing diagrams.

Table 18. FRAME TIMING

Device Pin	Full Resolution	
	16 Outputs	8 Outputs
V1T	F1T	F1B
V2T	F2T	F4B
V3T	F3T	F3B
V4T	F4T	F2B
V1B	F1B	
V2B	F2B	
V3B	F3B	
V4B	F4B	
FDGB, FDGT	FDG_L	
H1a to h	P1	P1
H2a to h	P2	P2
H2La to h	P2	P2
Ra to h	R	R
H1i to p	P1	P1 or see Note 1
H2i to p	P2	P2 or see Note 1
H2Li to p	P2	P2 or see Note 1
Ri to p	R	R or see Note 1

1. These clocks may all be held at their high level voltages or +5.0 V

KAI-47051

Line Timing

This timing is for transferring one line of charge from the VCCD to the HCCD. See Figure 26 and Figure 27 for line timing diagrams.

Table 19. LINE TIMING

Device Pin	Full Resolution	
	16 Outputs	8 Outputs
V1T	L1T	L1B
V2T	L2T	L4B
V3T	L3T	L3B
V4T	L4T	L2B
V1B	L1B	
V2B	L2B	
V3B	L3B	
V4B	L4B	
FDGB, FDGT	FDG_L	
H1a to h	P1L	P1L
H2a to h	P2L	P2L
H2La to h	P2L	P2L
Ra to h	R	R
H1i to p	P1L	P1 or see Note 1
H2i to p	P2L	P2 or see Note 1
H2Li to p	P2L	P2 or see Note 1
Ri to p	R	R or see Note 1

1. These clocks may all be held at their high level voltages or +5.0 V

KAI-47051

Pixel Timing

This timing is for transferring one pixel from the HCCD to the output amplifier.

Table 20. PIXEL TIMING

Device Pin	Full Resolution	
	16 Outputs	8 Outputs
V1T	V1_L	V1_L
V2T	V2_L	V2_L
V3T	V3_H	V3_H
V4T	V4_H	V4_H
V1B	V1_L	
V2B	V2_H	
V3B	V3_H	
V4B	V4_L	
FDGB, FDGT	FDG_L	
H1a to h	P1	P1
H2a to h	P2	P2
H2La to h	P2	P2
Ra to h	R	R
H1i to p	P1	P1 or see Note 1
H2i to p	P2	P2 or see Note 1
H2Li to p	P2	P2 or see Note 1
Ri to p	R	R or see Note 1

1. These clocks may all be held at their high level voltages or +5.0 V

Timing Diagrams

The charge in the photodiodes is transferred to the VCCD on the rising edge of the +13 V pulse and is completed by the falling edge of the V1_H pulse on F1T and F1B. During the

time period when F1T and F1B are at V1_H (Tpd) anti-blooming protection is disabled. The photodiode integration time ends on the falling edge of the Tpd pulse.

Frame Timing – 16 Output Mode



See the Pin Assignment table for pin assignments.

Figure 24. Frame Timing Diagram 16 Output Mode

Frame Timing- 8 Output Mode



See the Pin Assignment table for pin assignments.

Figure 25. Frame Timing Diagram 8 Output Mode

Line Timing – Full Resolution – 16 Output Mode

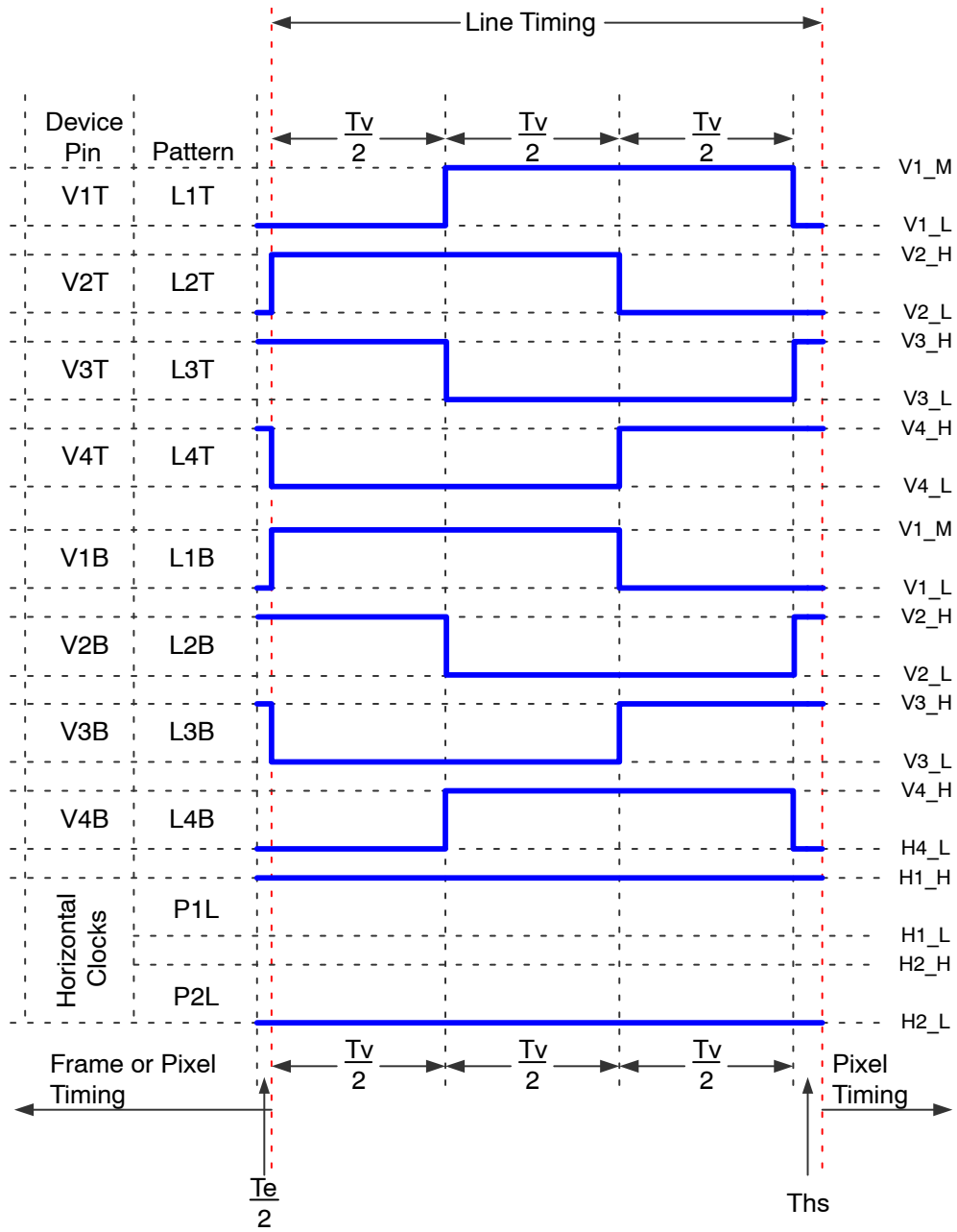

See the Pin Assignment table for pin assignments.

Figure 26. Line Timing Diagram – Full Resolution – 16 Output Mode

Line Timing – Full Resolution – 8 Output Mode



See the Pin Assignment table for pin assignments.

Figure 27. Line Timing Diagram – Full Resolution – 8 Output Mode

Electronic Shutter Timing Diagrams

The electronic shutter pulse can be inserted at the end of any line of the HCCD timing. The HCCD should be empty when the electronic shutter is pulsed. A recommended position for the electronic shutter is just after the last pixel is read out of a line. The VCCD clocks should not resume until at least T_{hd} after the electronic shutter pulse has finished. The HCCD clocks can be run during the electronic

shutter pulse as long as the HCCD does not contain valid image data.

For short exposures less than one line time, the electronic shutter pulse can appear inside the frame timing. Any electronic shutter pulse transition should be T_{hd} away from any VCCD clock transition.



Figure 28. Electronic Shutter Timing

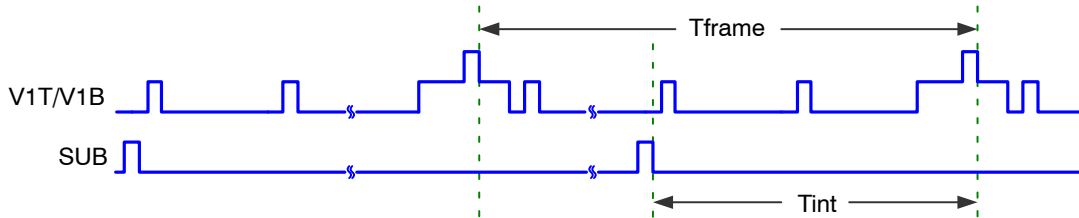

Figure 29. Frame/Electronic Shutter Timing

Pixel Timing – Full Resolution – All Output Modes

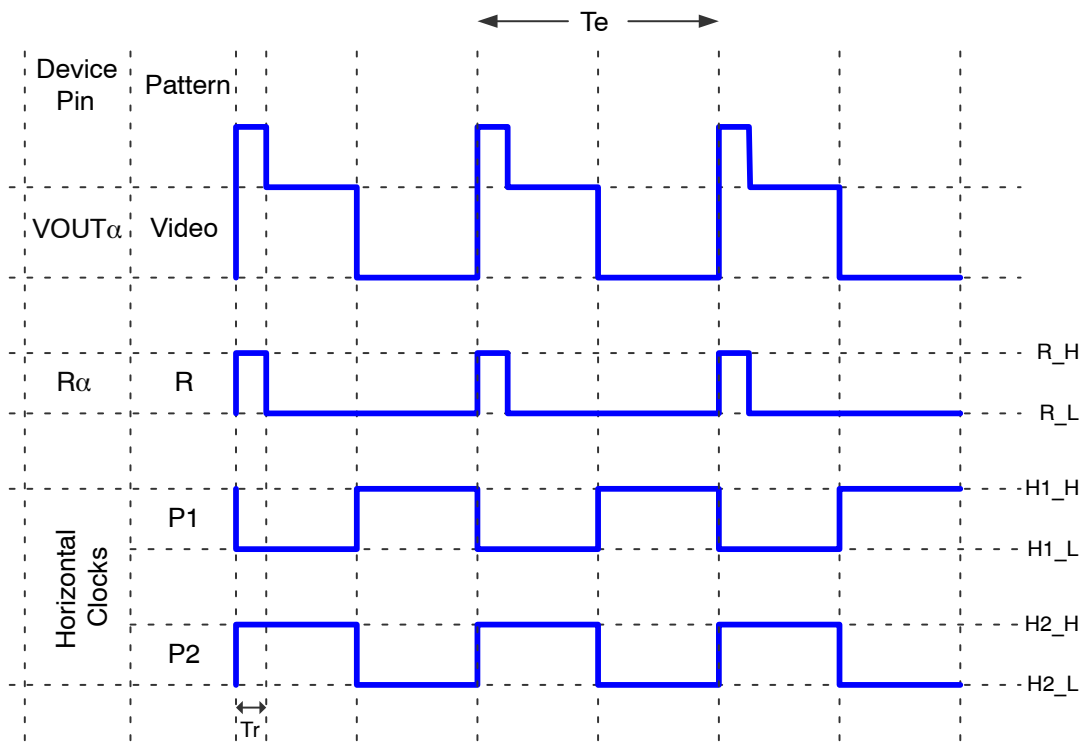

Figure 30. Pixel Timing Diagram – Full Resolution

VCCD Clock Edge Alignment

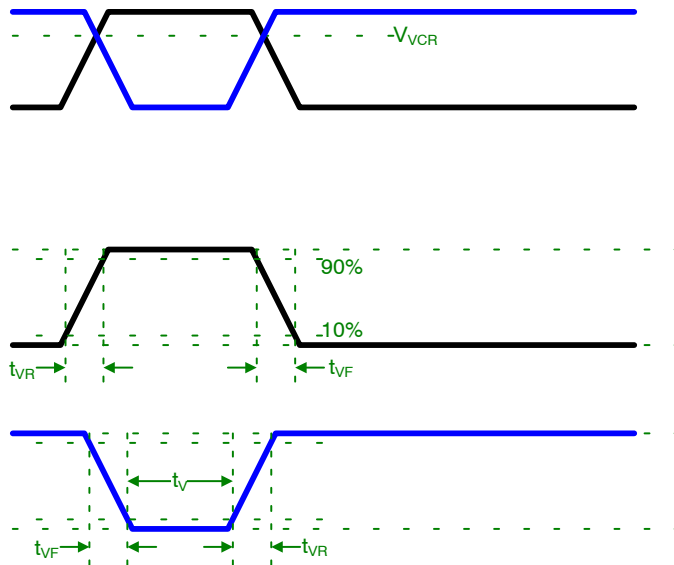

Figure 31. VCCD Clock Rise Time, Fall Time and Edge Alignment

Fast Line Dump Timing

The FDG pins may be optionally clocked to efficiently remove unwanted pins in the image resulting for increased frame rates at the expense of resolution. Below is an example of a 2 line dump sequence followed by a normal readout line.

Note that the FDG timing transitions should complete prior to the beginning of vertical timing transitions as illustrated below.



Figure 32. Fast Line Dump Timing Diagram

STORAGE AND HANDLING

Table 21. STORAGE CONDITIONS

Description	Symbol	Minimum	Maximum	Units	Notes
Storage Temperature	T _{ST}	-55	80	°C	1
Humidity	RH	5	90	%	2

1. Long-term storage toward the maximum temperature will accelerate color filter degradation.
2. T = 25°C. Excessive humidity will degrade MTTF.

For information on ESD and cover glass care and cleanliness, please download the *Image Sensor Handling and Best Practices* Application Note (AN52561/D) from www.onsemi.com.

For information on environmental exposure, please download the *Using Interline CCD Image Sensors in High Intensity Lighting Conditions* Application Note (AND9183/D) from www.onsemi.com.

For information on soldering recommendations, please download the *Soldering and Mounting Techniques Reference Manual* (SOLDERRM/D) from www.onsemi.com.

For quality and reliability information, please download the *Quality & Reliability Handbook* (HBD851/D) from www.onsemi.com.

For information on device numbering and ordering codes, please download the *Device Nomenclature* technical note (TND310/D) from www.onsemi.com.

For information on Standard terms and Conditions of Sale, please download [Terms and Conditions](http://www.onsemi.com) from www.onsemi.com.

MECHANICAL INFORMATION

Completed Assembly



Notes:

1. See Ordering Information for marking code.
2. Pin to pin distances are measured at pin base.
3. Pins are not centered about the vertical axis.
4. Units: mm

Figure 33. Completed Assembly (1 of 2)

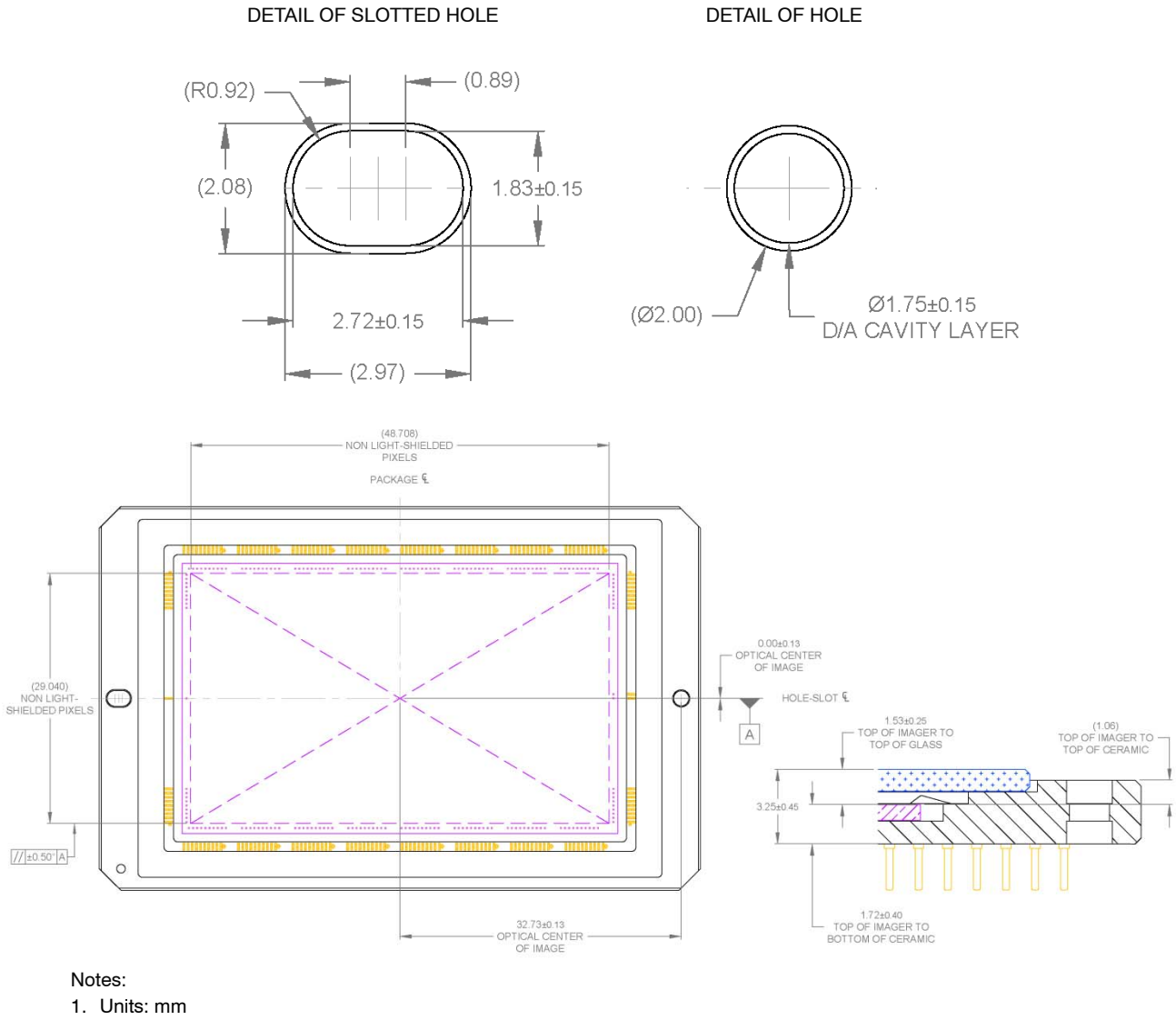

Figure 34. Completed Assembly (2 of 2)

Cover Glass



Notes:

1. Substrate = Schott D263T eco
2. Dust, Scratch, Inclusion Specification:
 - a.) 20 microns maximum size in Zone A
3. MAR coated both sides
4. Spectral Transmission
 - a.) 350 - 365 nm: $T \geq 88\%$
 - b.) 365 - 405 nm: $T \geq 94\%$
 - c.) 405 - 450 nm: $T \geq 98\%$
 - d.) 450 - 650 nm: $T \geq 99\%$
 - e.) 650 - 690 nm: $T \geq 98\%$
 - f.) 690 - 770 nm: $T \geq 94\%$
 - g.) 770 - 870 nm: $T \geq 88\%$
5. Units: mm

Figure 35. Cover Glass

Cover Glass Transmission



Figure 36. Cover Glass Transmission

ON Semiconductor and the  are registered trademarks of Semiconductor Components Industries, LLC (SCILLC) or its subsidiaries in the United States and/or other countries. SCILLC owns the rights to a number of patents, trademarks, copyrights, trade secrets, and other intellectual property. A listing of SCILLC's product/patent coverage may be accessed at www.onsemi.com/site/pdf/Patent-Marking.pdf. SCILLC reserves the right to make changes without further notice to any products herein. SCILLC makes no warranty, representation or guarantee regarding the suitability of its products for any particular purpose, nor does SCILLC assume any liability arising out of the application or use of any product or circuit, and specifically disclaims any and all liability, including without limitation special, consequential or incidental damages. "Typical" parameters which may be provided in SCILLC data sheets and/or specifications can and do vary in different applications and actual performance may vary over time. All operating parameters, including "Typicals" must be validated for each customer application by customer's technical experts. SCILLC does not convey any license under its patent rights nor the rights of others. SCILLC products are not designed, intended, or authorized for use as components in systems intended for surgical implant into the body, or other applications intended to support or sustain life, or for any other application in which the failure of the SCILLC product could create a situation where personal injury or death may occur. Should Buyer purchase or use SCILLC products for any such unintended or unauthorized application, Buyer shall indemnify and hold SCILLC and its officers, employees, subsidiaries, affiliates, and distributors harmless against all claims, costs, damages, and expenses, and reasonable attorney fees arising out of, directly or indirectly, any claim of personal injury or death associated with such unintended or unauthorized use, even if such claim alleges that SCILLC was negligent regarding the design or manufacture of the part. SCILLC is an Equal Opportunity/Affirmative Action Employer. This literature is subject to all applicable copyright laws and is not for resale in any manner.

PUBLICATION ORDERING INFORMATION

LITERATURE FULFILLMENT:
 Literature Distribution Center for ON Semiconductor
 19521 E. 32nd Pkwy, Aurora, Colorado 80011 USA
Phone: 303-675-2175 or 800-344-3860 Toll Free USA/Canada
Fax: 303-675-2176 or 800-344-3867 Toll Free USA/Canada
Email: orderlit@onsemi.com

N. American Technical Support: 800-282-9855 Toll Free
 USA/Canada
Europe, Middle East and Africa Technical Support:
 Phone: 421 33 790 2910
Japan Customer Focus Center
 Phone: 81-3-5817-1050

ON Semiconductor Website: www.onsemi.com
Order Literature: <http://www.onsemi.com/orderlit>
 For additional information, please contact your local
 Sales Representative



Компания «ЭлектроПласт» предлагает заключение долгосрочных отношений при поставках импортных электронных компонентов на взаимовыгодных условиях!

Наши преимущества:

- Оперативные поставки широкого спектра электронных компонентов отечественного и импортного производства напрямую от производителей и с крупнейших мировых складов;
- Поставка более 17-ти миллионов наименований электронных компонентов;
- Поставка сложных, дефицитных, либо снятых с производства позиций;
- Оперативные сроки поставки под заказ (от 5 рабочих дней);
- Экспресс доставка в любую точку России;
- Техническая поддержка проекта, помощь в подборе аналогов, поставка прототипов;
- Система менеджмента качества сертифицирована по Международному стандарту ISO 9001;
- Лицензия ФСБ на осуществление работ с использованием сведений, составляющих государственную тайну;
- Поставка специализированных компонентов (Xilinx, Altera, Analog Devices, Intersil, Interpoint, Microsemi, Aeroflex, Peregrine, Syfer, Eurofarad, Texas Instrument, Miteq, Cobham, E2V, MA-COM, Hittite, Mini-Circuits, General Dynamics и др.);

Помимо этого, одним из направлений компании «ЭлектроПласт» является направление «Источники питания». Мы предлагаем Вам помощь Конструкторского отдела:

- Подбор оптимального решения, техническое обоснование при выборе компонента;
- Подбор аналогов;
- Консультации по применению компонента;
- Поставка образцов и прототипов;
- Техническая поддержка проекта;
- Защита от снятия компонента с производства.



Как с нами связаться

Телефон: 8 (812) 309 58 32 (многоканальный)

Факс: 8 (812) 320-02-42

Электронная почта: org@eplast1.ru

Адрес: 198099, г. Санкт-Петербург, ул. Калинина, дом 2, корпус 4, литера А.