

General purpose Chassis and PCB mount

A series of compact, high performance, low leakage PCB and chassis mount suppression filters - with multiple combinations of enclosure size, current ratings and termination styles. This range offers flexibility and economy. Typical applications include industrial measuring equipment, consumer electronics and low power SMPS.

- Current ratings from 0.5A to 10A
- Compact PCB or chassis mount footprint
- Low profile variants (FAH)
- PCB or fast-on terminations
- Medical versions available



Mechanical Specifications

Manufacture: plastic case sealed with self-extinguishing resin.

Connections: for PCB mounting (FA-AV) or with faston 2.8x0.5mm (FA-AA FA-DA)

Electrical Specifications

Rated voltage (V_R): max 250V, 50/60Hz

Rated current (I_R): referred to room temperature = 40°C

Leakage current (I_L): at 220V, 50Hz, max value

Voltage test (2 s.): line to ground 3000Vdc or 1800Vac
line to line 1700Vdc

Climatic category: HPF (25/085/21);
Temperature range: -25°C to +85°C

Filter Range

Code	I_R (A)	L (mH)	C_x (μ F)	C_y (pF)	I_L (mA)	R (M Ω)	Circ Diag
FAH -- 3100ZA	0.5	2x40	0.1	2x2500	2x0.23		A ●
FAH -- 3100ZB	1	2x10	0.1	2x2500	2x0.23		A ●
FAH -- 3100ZC	1.6	2x6	0.1	2x2500	2x0.23		A ●
FAH -- 3100ZD	2.5	2x2	0.1	2x2500	2x0.23		A ●
FAH -- 3100ZE	4	2x1	0.1	2x2500	2x0.23		A ●
FAH -- 3100ZF	6.5	2x1	0.1	2x2500	2x0.23		A ●
▲ FAH -- 3100ZG	5	2x2	0.1	2x2500	2x0.23		A ●
▲ FAH -- 3100ZK	0.5	2x40	0.1	2x4700	2x0.43		A ●
▲ FAH -- 3100ZL	1	2x10	0.1	2x4700	2x0.43		A ●
▲ FAH -- 3100ZM	1.6	2x6	0.1	2x4700	2x0.43		A ●
▲ FAH -- 3100ZN	2.5	2x2	0.1	2x4700	2x0.43		A ●
▲ FAH -- 3100ZP	6.5	2x1	0.1	2x4700	2x0.43		A ●
FAH -- 3200ZA	0.5	2x40	2x0.1		2x0.02		E
FAH -- 3200ZB	1	2x10	2x0.1		2x0.02		E
FAH -- 3200ZC	1.6	2x6	2x0.1		2x0.02		E
FAH -- 3200ZD	2.5	2x2	2x0.1		2x0.02		E
FAH -- 3200ZE	4	2x1	2x0.1		2x0.02		E
FAH -- 3200ZF	6.5	2x1	2x0.1		2x0.02		E
■ FAA -- 3100ZA	10	2x1	0.1	2x2500	2x0.23	1	A
▲ FAA -- 3100ZB	1	2x10	0.1	2x2500	2x0.23		A
▲ FAA -- 3220ZB	0.5	2x40	0.22	2x2200	2x0.20	1.5	B
▲ FAA -- 3220ZC	6.5	2x1	0.22	2x2500	2x0.23	1	A
▲ FAA -- 3330ZA	0.5	2x40	0.33	2x4700	2x0.43	1	C
▲ FAA -- 3680ZA	0.5	2x40	0.68	2x4700	2x0.43	0.47	C

 A = Faston 2.8 x 0.5mm
 V = for PCB mounting
 A = Case without brackets
 D = Case with brackets

▲ No approvals. ● Also available in circuit B on request, no approvals. ■ VDE approved only.

* other variants on request

Dimensions (mm) and connections

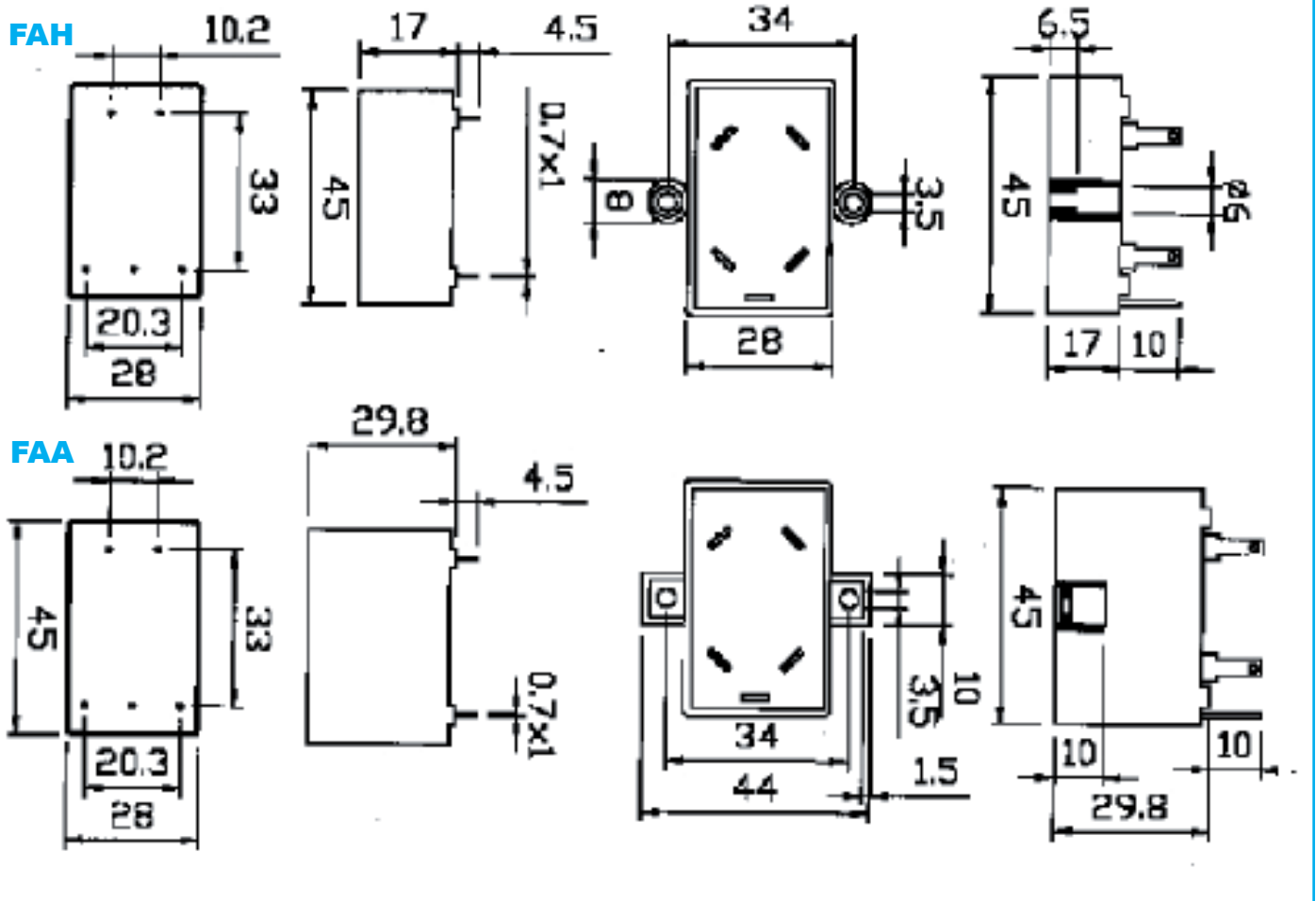

Circuit diagram

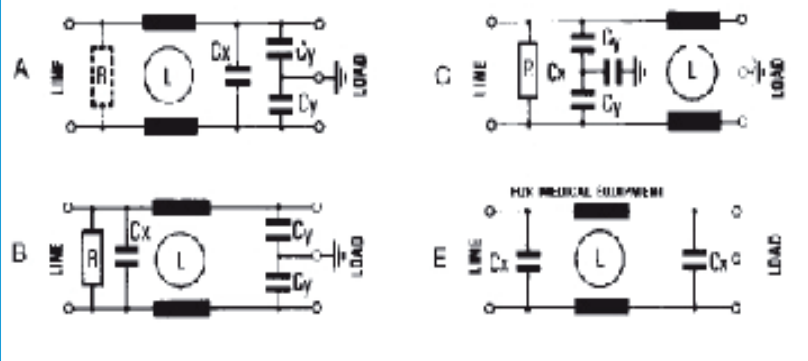

Insertion loss (typical): — Asymmetrical (line to ground) - - - Symmetrical (line to line)

FAH

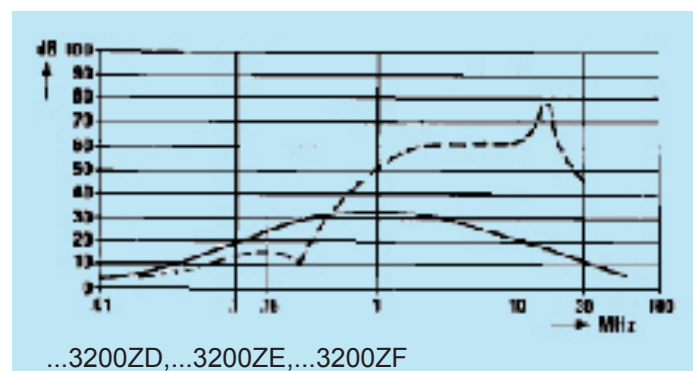
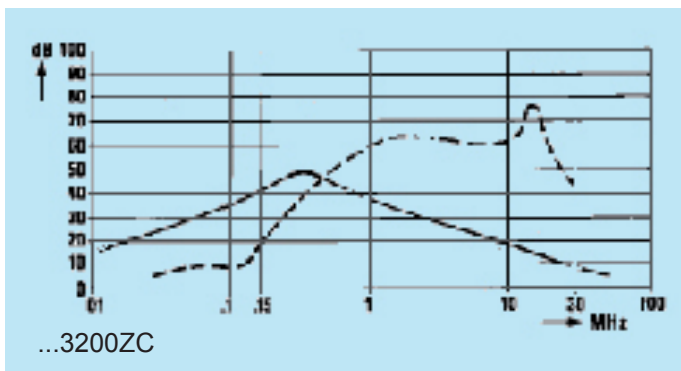
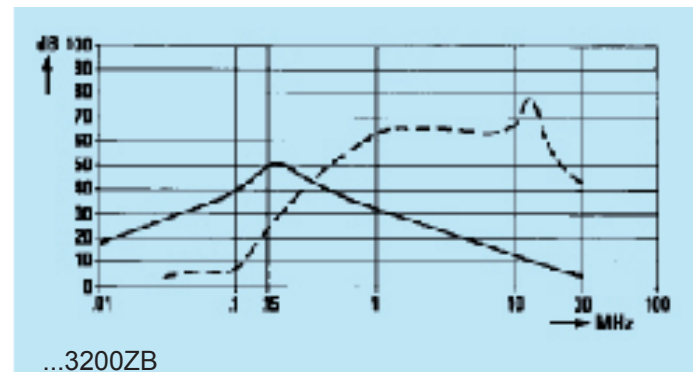
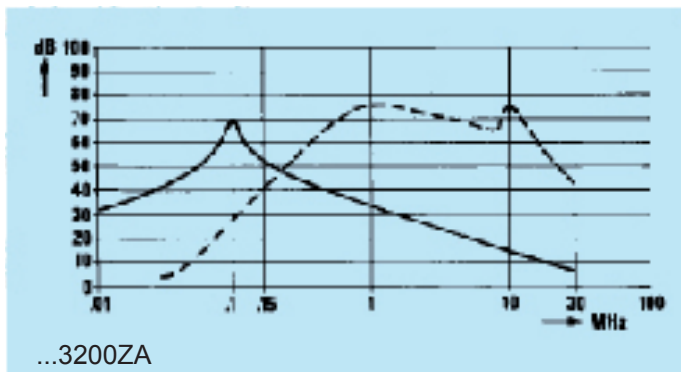
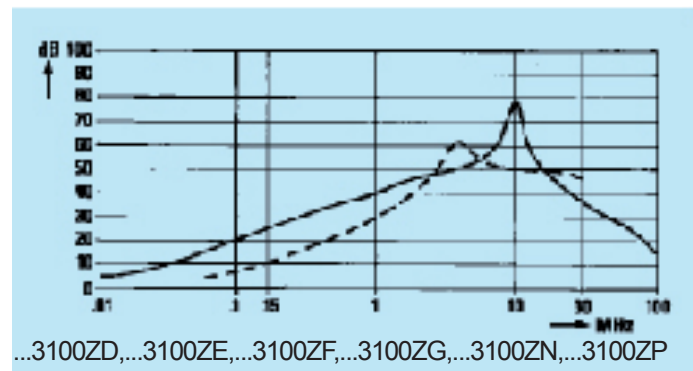
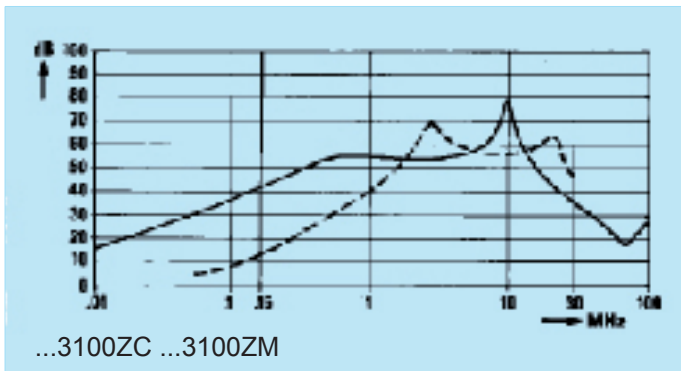
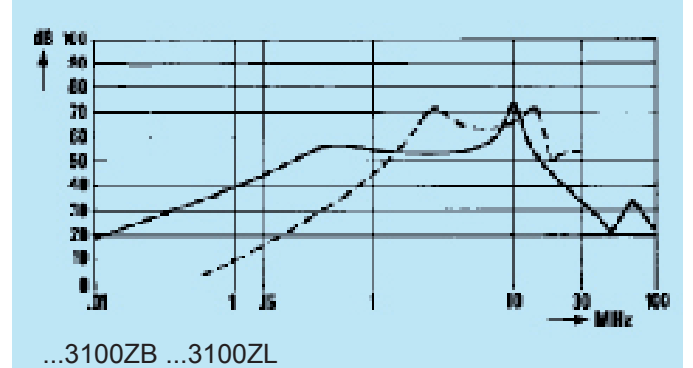
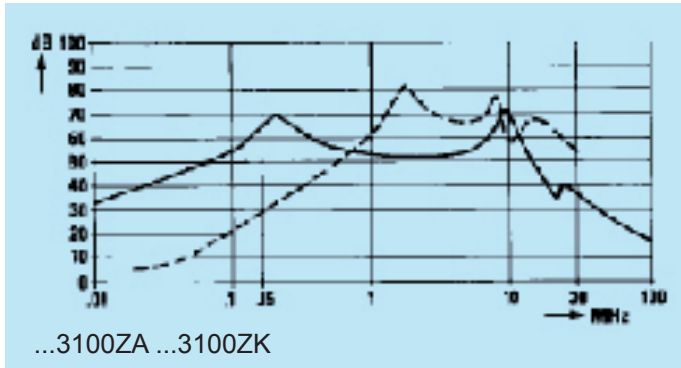

Insertion loss (typical): — Asymmetrical (line to ground) - - - Symmetrical (line to line)

FAA

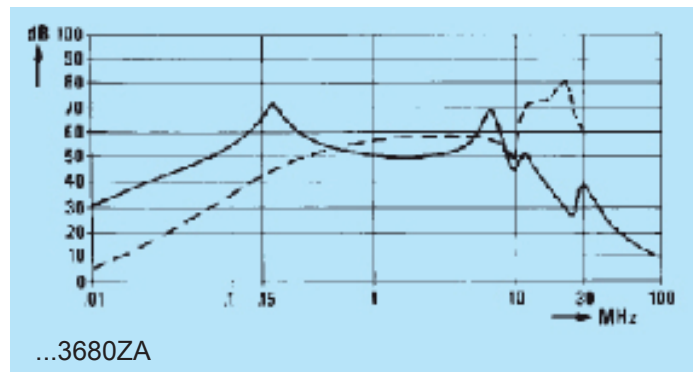
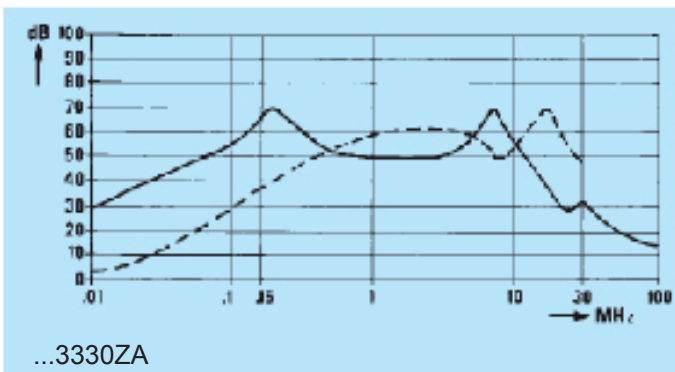
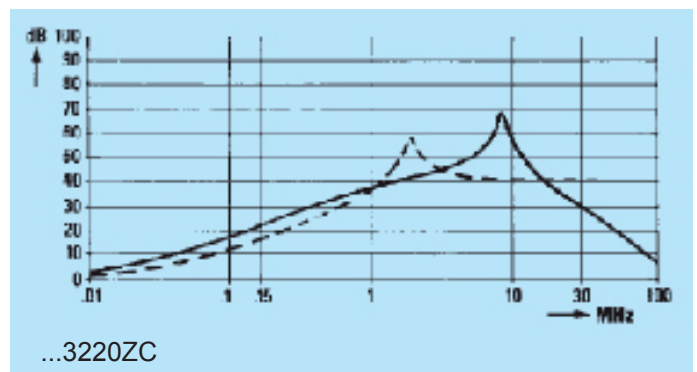
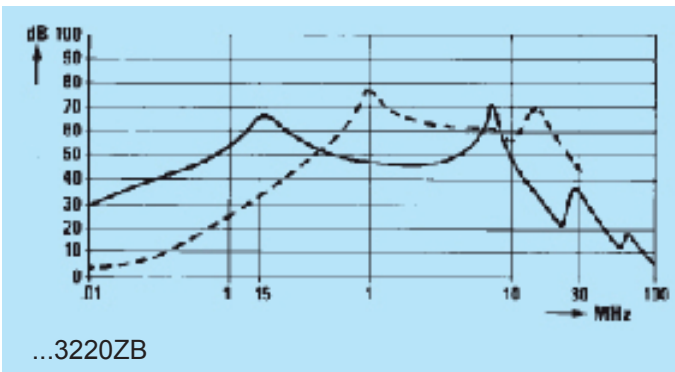
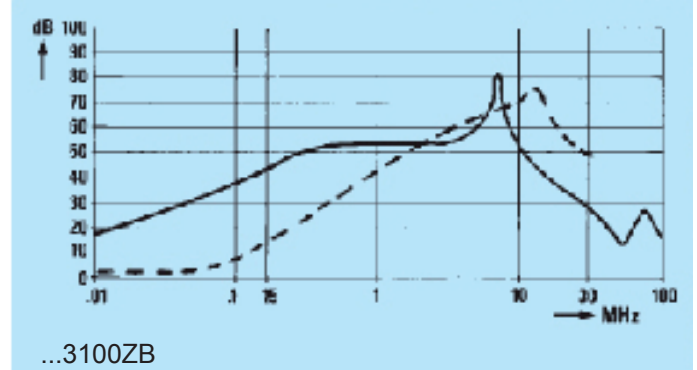
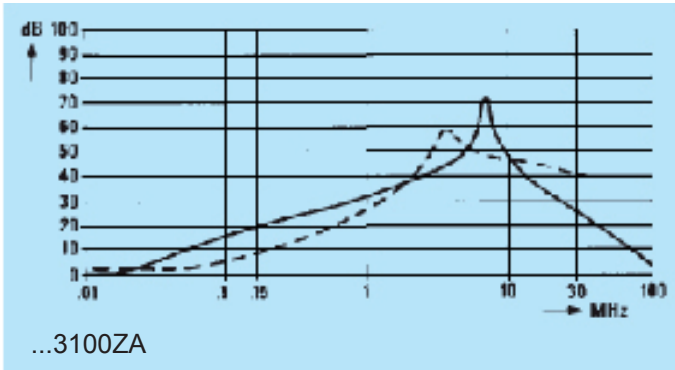

High performance

This range provides a high level of performance within compact metal enclosures for printed circuit board configurations.

Specifically designed to protect against symmetric, asymmetric, periodic and pulse shaped RFI.

Ideal for use with office equipment, telecom products, computers and industrial applications.

- Current ratings from 3A to 16A
- PCM mount termination
- High RFI attenuation
- Single or two stage circuit designs
- Medical versions available

Mechanical Specifications

Manufacture: metal case sealed with self-extinguishing resin.
 Connections: for PCB mounting; ground terminal connected to case.

Filter Range

Code	I _R (A)	L (mH)	L ₁ (mH)	Cx ₁ (μF)	Cx ₂ (μF)	Cy1 (pF)	Cy2 (pF)	I _L (mA)	R (MΩ)	Circ diag
FAMAV3600ZC010	16	2x1			0.6	2x2500		2x0.23	1	A
▲ FAMAV3600ZI010	16	2x1			0.6	2x6800		2x0.62	1	A
FAMAV3940ZA	3.3	2x13		0.47	0.47	2x6800		2x0.62	0.33	B
FAMAV3940ZB001	3.3	2x13	2x1	0.47	0.47	2x6800	2x1000	2x.072	0.68	C

▲ UL approval only
 * other variants on request

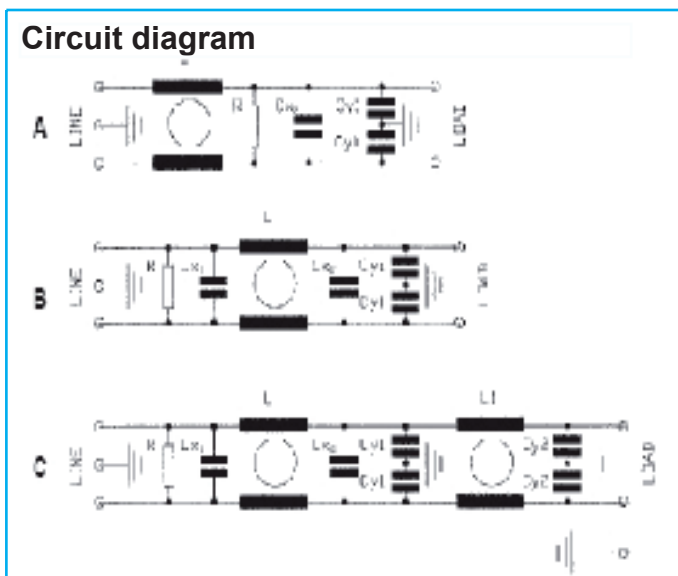

Electrical Specifications

Rated voltage (V_R): max 250V, 50/60Hz
 Rated current (I_R): referred to room temperature = 40°C
 Leakage current (I_L): at 220V, 50Hz, max value
 Voltage test (2 s.): line to ground 3000Vdc or 1800Vac
 line to line 1700Vdc
 Climatic category: HPF (25/085/21);
 Temperature range: -25°C to +85°C

Dimensions (mm) and connections

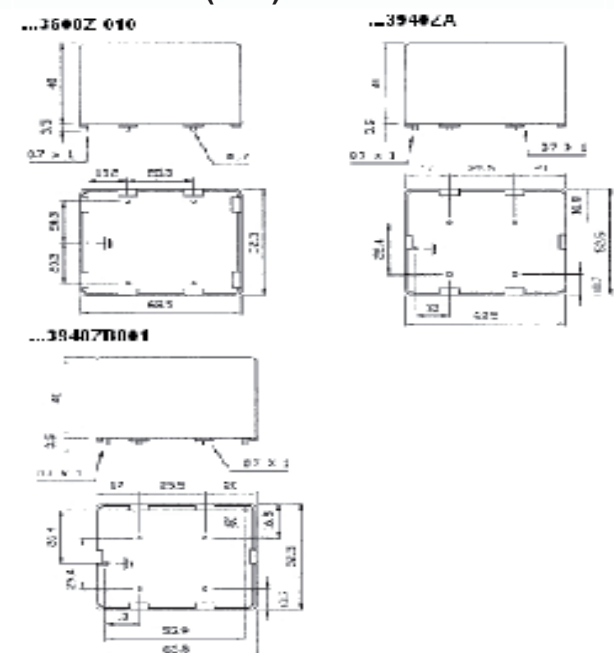

Approvals



in progress



1283



22.2 N°8



Insertion loss (typical): — Asymmetrical (line to ground) - - - Symmetrical (line to line)

FAMAV

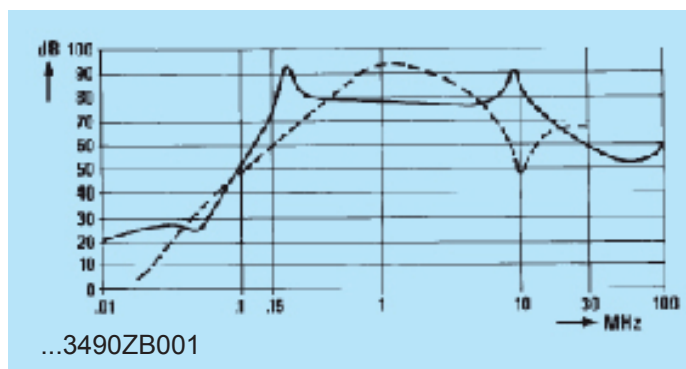
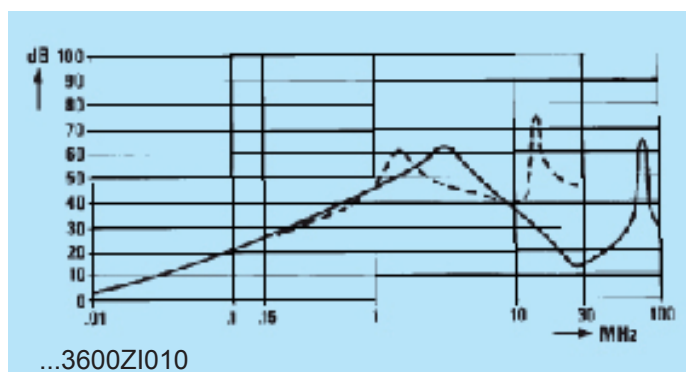
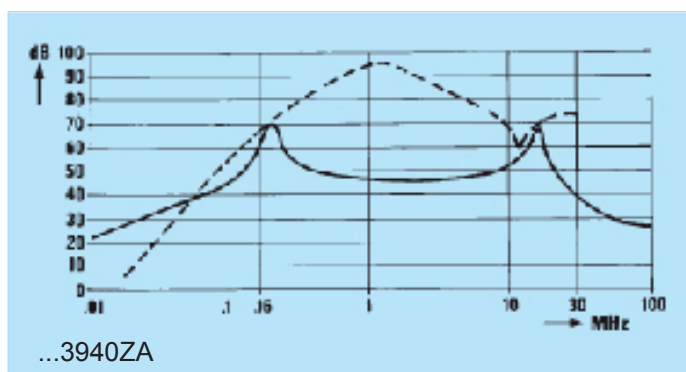
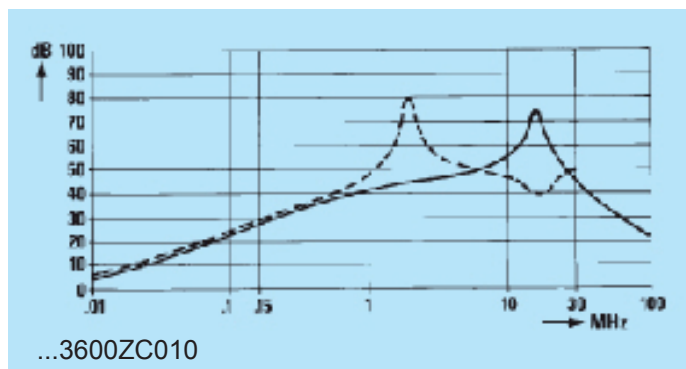



Компания «ЭлектроПласт» предлагает заключение долгосрочных отношений при поставках импортных электронных компонентов на взаимовыгодных условиях!

Наши преимущества:

- Оперативные поставки широкого спектра электронных компонентов отечественного и импортного производства напрямую от производителей и с крупнейших мировых складов;
- Поставка более 17-ти миллионов наименований электронных компонентов;
- Поставка сложных, дефицитных, либо снятых с производства позиций;
- Оперативные сроки поставки под заказ (от 5 рабочих дней);
- Экспресс доставка в любую точку России;
- Техническая поддержка проекта, помощь в подборе аналогов, поставка прототипов;
- Система менеджмента качества сертифицирована по Международному стандарту ISO 9001;
- Лицензия ФСБ на осуществление работ с использованием сведений, составляющих государственную тайну;
- Поставка специализированных компонентов (Xilinx, Altera, Analog Devices, Intersil, Interpoint, Microsemi, Aeroflex, Peregrine, Syfer, Eurofarad, Texas Instrument, Miteq, Cobham, E2V, MA-COM, Hittite, Mini-Circuits, General Dynamics и др.);

Помимо этого, одним из направлений компании «ЭлектроПласт» является направление «Источники питания». Мы предлагаем Вам помощь Конструкторского отдела:

- Подбор оптимального решения, техническое обоснование при выборе компонента;
- Подбор аналогов;
- Консультации по применению компонента;
- Поставка образцов и прототипов;
- Техническая поддержка проекта;
- Защита от снятия компонента с производства.



Как с нами связаться

Телефон: 8 (812) 309 58 32 (многоканальный)

Факс: 8 (812) 320-02-42

Электронная почта: org@eplast1.ru

Адрес: 198099, г. Санкт-Петербург, ул. Калинина, дом 2, корпус 4, литера А.