



LUXEON M

Brightest, most uniform and highest efficacy multi-die emitter

LUXEON M is an illumination grade multi-die LED designed to enable outdoor and industrial applications targeting either high efficiency or low cost. With *Freedom from Binning* and leading performance, LUXEON M falls within a single 3- or 5-step MacAdam ellipse centered in ANSI to ensure color consistency from LED to LED, delivering high efficacy and high flux density from a uniform source with tight correlated color temperature control. The superior quality of light, volume of lumens, and real world efficacy enable leading performance and efficient solution development in a wide variety of lighting segments.



FEATURES AND BENEFITS

Uniform image enables tight beam control in MR16 and spotlight applications

High flux density from a 3mm² area enables reduced emitter count and compact fixture designs

11.2V, 5.6V and 2.8V package options puts high performance within reach with high efficiency and low cost drivers

Leading thermal resistance allows flexible system design to optimize for lm/\$ and lm/W

Exceeds ENERGY STAR® lumen maintenance requirements

PRIMARY APPLICATIONS

Architectural

High Bay & Low Bay

Lamps

Outdoor

Specialty Lighting

Spotlights

Table of Contents

General Product Information	2
Product Test Conditions	2
Part Number Nomenclature	2
Lumen Maintenance	2
Environmental Compliance	2
Performance Characteristics	3
Product Selection Guide	3
Optical Characteristics	4
Electrical and Thermal Characteristics	4
Absolute Maximum Ratings	5
Operating Conditions	5
Characteristic Curves	6
Spectral Power Distribution Characteristics	6
Light Output Characteristics	8
Forward Current Characteristics	10
Radiation Pattern Characteristics	12
Product Bin and Labeling Definitions	13
Decoding Product Bin Labeling	13
Luminous Flux Bins	14
Radiometric Power Bins	14
Color Bin Definition	15
Dominant Wavelength Bins	15
Forward Voltage Bins	16
Mechanical Dimensions	16
Reflow Soldering Guidelines	17
JEDEC Moisture Sensitivity	17
Solder Pad Design	18
Packaging Information	19
Pocket Tape Dimensions	19
Reel Dimensions	20

General Product Information

Product Test Conditions

LUXEON M LEDs are tested and binned with a DC drive current of 700mA for LUXEON M 12V, 1400mA for LUXEON M 6V and 2800mA for LUXEON M 3V at a junction temperature, T_j , of 85°C.

Part Number Nomenclature

Part numbers for LUXEON M follow the convention below:

L X R **A - B C D D - E E E E**

Where:

- A** – designates minimum CRI (7=70, 8=80, 9=90, 0=Royal Blue)
- B** – designates voltage (S=12V, R=6V, Q=3V)
- C** – designates color (W=White, R=Royal Blue)
- D D** – designates CCT (27=2700K, 30=3000K, 35=3500K, 40=4000K, 50=5000K, 57=5700K, 65=6500K, 00=Royal Blue)
- E E E E** – designates minimum luminous flux (optional)

Therefore, the following part number is used for a white LUXEON M 12V 3000K 80CRI:

L X R **8 - S W 3 0 - x x x x**

Lumen Maintenance

Please contact your local Sales Representative or Lumileds Technical Solutions Manager for more information about the long-term performance of this product.

Environmental Compliance

Lumileds LLC is committed to providing environmentally friendly products to the solid-state lighting market. LUXEON M is compliant to the European Union directives on the restriction of hazardous substances in electronic equipment, namely the RoHS Directive 2011/65/EU and REACH Regulation (EC) 1907/2006. Lumileds LLC will not intentionally add the following restricted materials to its products: lead, mercury, cadmium, hexavalent chromium, polybrominated biphenyls (PBB) or polybrominated diphenyl ethers (PBDE).

Performance Characteristics

Product Selection Guide

Table 1a. Product performance for LUXEON M White at test current, $T_j=85^\circ\text{C}$.

VOLTAGE	NOMINAL CCT [2]	MINIMUM CRI	LUMINOUS FLUX [1] (lm)		TEST CURRENT (mA)	PART NUMBER
			MINIMUM	TYPICAL		
12V	3000K	70	900	1000	700	LXR7-SW30
	4000K	70	970	1076	700	LXR7-SW40
	5000K	70	1040	1100	700	LXR7-SW50
	5700K	70	1040	1110	700	LXR7-SW57
	6500K	70	1040	1130	700	LXR7-SW65
	2700K	80	730	800	700	LXR8-SW27
	3000K	80	780	850	700	LXR8-SW30
	3500K	80	780	870	700	LXR8-SW35
	4000K	80	840	905	700	LXR8-SW40
	5000K	80	840	920	700	LXR8-SW50
	2700K	90	600	660	700	LXR9-SW27
	3000K	90	640	736	700	LXR9-SW30
	5700K	90	800	880	700	LXR9-SW57
	6V	3000K	70	900	1000	1400
4000K		70	970	1076	1400	LXR7-RW40
5000K		70	1040	1100	1400	LXR7-RW50
5700K		70	1040	1110	1400	LXR7-RW57
6500K		70	1040	1130	1400	LXR7-RW65
2700K		80	730	800	1400	LXR8-RW27
3000K		80	780	850	1400	LXR8-RW30
3500K		80	780	870	1400	LXR8-RW35
4000K		80	840	920	1400	LXR8-RW40
5000K		80	840	920	1400	LXR8-RW50
2700K		90	600	660	1400	LXR9-RW27
3000K		90	640	736	1400	LXR9-RW30
5700K		90	800	880	1400	LXR9-RW57
3V		3000K	70	900	1000	2800
	4000K	70	970	1076	2800	LXR7-QW40
	5000K	70	1040	1100	2800	LXR7-QW50
	5700K	70	1040	1110	2800	LXR7-QW57
	6500K	70	1040	1130	2800	LXR7-QW65
	2700K	80	730	800	2800	LXR8-QW27
	3000K	80	780	850	2800	LXR8-QW30
	3500K	80	780	870	2800	LXR8-QW35
	4000K	80	840	920	2800	LXR8-QW40
	5000K	80	840	920	2800	LXR8-QW50
	2700K	90	600	660	2800	LXR9-QW27
	3000K	90	640	736	2800	LXR9-QW30
	5700K	90	800	880	2800	LXR9-QW57

Notes for Table 1a:

1. Lumileds maintains a tolerance of ± 2 on CRI and $\pm 6.5\%$ on luminous flux measurements.
2. Typical CRI is approximately 2 points higher than the minimum CRI specified, but this is not guaranteed.

Table 1b. Product performance for LUXEON M Royal Blue at test current, $T_j=85^\circ\text{C}$.

VOLTAGE	DOMINANT WAVELENGTH (nm)		RADIOMETRIC POWER (mW)		TEST CURRENT (mA)	PART NUMBER
	MINIMUM	MAXIMUM	MINIMUM	TYPICAL		
12V	445	460	4200	4500	700	LXR0-SR00
6V	445	460	4200	4500	1400	LXR0-RR00
3V	445	460	4200	4500	2800	LXR0-QR00

Notes for Table 1b:

1. Lumileds maintains a tolerance of $\pm 6.5\%$ on radiometric power measurements.

Optical Characteristics

Table 2. Optical characteristics for LUXEON M at test current, $T_j=85^\circ\text{C}$.

PART NUMBER	TYPICAL TOTAL INCLUDED ANGLE ^[1]	TYPICAL VIEWING ANGLE ^[2]
LXR-xxxx	140°	120°

Notes for Table 2:

1. Total angle at which 90% of total luminous flux is captured.
2. Viewing angle is the off axis angle from the LED centerline where the luminous intensity is ½ of the peak value.

Electrical and Thermal Characteristics

Table 3. Electrical and thermal characteristics for LUXEON M at test current, $T_j=85^\circ\text{C}$.

PART NUMBER	FORWARD VOLTAGE (V) ^[1]			TYPICAL TEMPERATURE COEFFICIENT OF FORWARD VOLTAGE (mV/°C) ^[2]	TYPICAL THERMAL RESISTANCE — JUNCTION TO SOLDER PAD (°C/W)
	MINIMUM	TYPICAL	MAXIMUM		
LXR-Sxxx	10.50	11.20	11.70	-5.50	1.25
LXR-Rxxx	5.25	5.60	6.00	-2.75	1.25
LXR-Qxxx	2.63	2.80	3.00	-1.38	1.25

Notes for Table 3:

1. Lumileds maintains a tolerance of $\pm 0.06\text{V}$ on forward voltage measurements.
2. Measured between 25°C and 135°C .

Absolute Maximum Ratings

Table 4. Absolute maximum ratings for LUXEON M.

PARAMETER	MAXIMUM PERFORMANCE
DC Forward Current at $T_j=110^{\circ}\text{C}$ ^{[1][2]}	1200mA for LXR _x -SW _{xx} 2400mA for LXR _x -RW _{xx} 4800mA for LXR _x -QW _{xx}
DC Forward Current at $T_j=135^{\circ}\text{C}$ ^{[1][2]}	1050mA for LXR _x -S _{xxx} 2100mA for LXR _x -R _{xxx} 4200mA for LXR _x -Q _{xxx}
Peak Pulsed Forward Current ^[3]	1375mA for LXR _x -SW _{xx} 2750mA for LXR _x -RW _{xx} 5500mA for LXR _x -QW _{xx} 1200mA for LXR0-SR00 2400mA for LXR0-RR00 4800mA for LXR0-QR00
LED Junction Temperature (DC & Pulse)	-40°C to 135°C
ESD Sensitivity (ANSI/ESDA/JEDEC JS-001-2012)	Class 3B
Operating Case Temperature ^[1]	120°C
Storage Temperature	-40°C to 120°C
Soldering Temperature	JEDEC 020c 260°C
Allowable Reflow Cycles	3
Reverse Voltage (V_{reverse})	LUXEON LEDs are not designed to be driven in reverse bias

Notes for 4:

- See Figure 1 for more details on the maximum permissible operating conditions for LUXEON M White.
- Residual periodic variations due to power conversion from alternating current (AC) to direct current (DC), also called "ripple", are acceptable if the following conditions are met:
 - The frequency of the ripple current is 100Hz or higher
 - The average current for each cycle does not exceed the maximum allowable DC forward current at this junction temperature
 - The maximum amplitude of the ripple does not exceed 15% of the maximum allowable DC forward current at this junction temperature
- At 10% duty cycle with pulse width of 10ms.

Operating Conditions

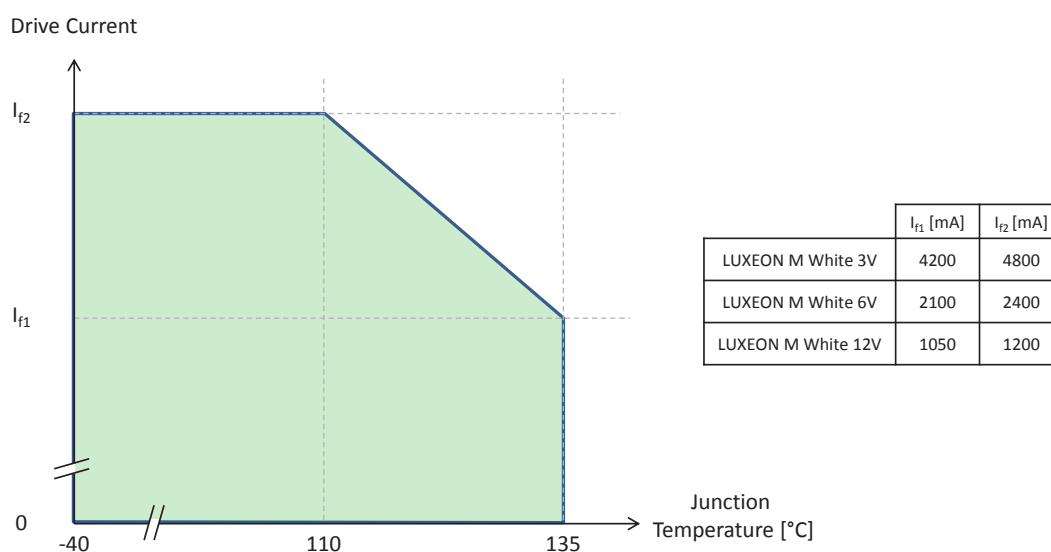

Figure 1: Maximum permissible operating conditions for LUXEON M White.

Notes for Figure 1:

- The green shaded area in this graph reflects the maximum permissible operating conditions for LUXEON M White.

Characteristic Curves

Spectral Power Distribution Characteristics



Figure 2a: Typical normalized power vs. wavelength for LXR7-xWxx at test current, $T_j=85^{\circ}\text{C}$.



Figure 2b: Typical normalized power vs. wavelength for LXR8-xWxx at test current, $T_j=85^{\circ}\text{C}$.



Figure 2c: Typical normalized power vs. wavelength for LXR9-xWxx at test current, $T_j=85^\circ\text{C}$.



Figure 2d: Typical normalized power vs. wavelength for LXR0-xR00 at test current, $T_j=85^\circ\text{C}$.

Light Output Characteristics

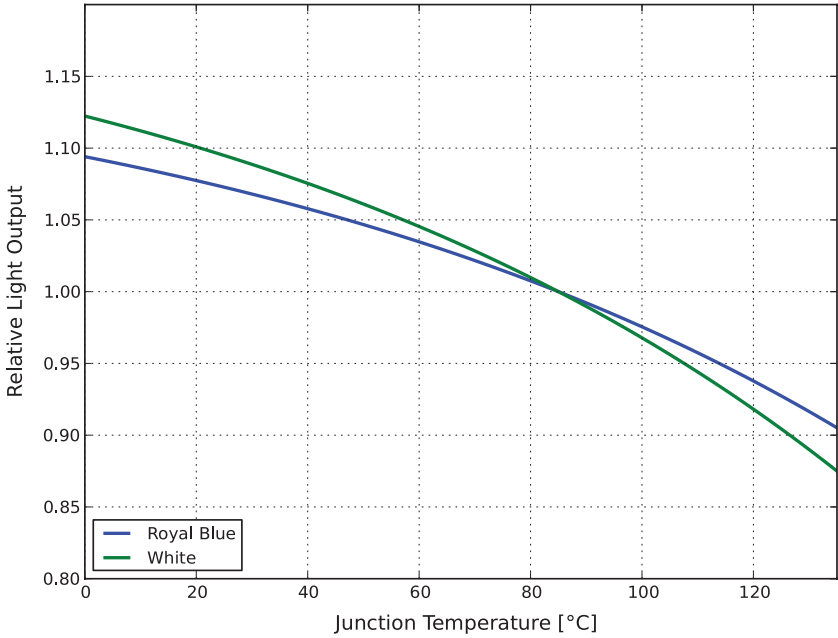

Figure 3: Typical normalized light output vs. junction temperature for LXRx-xxxx at test current, $T_j=85^\circ\text{C}$.

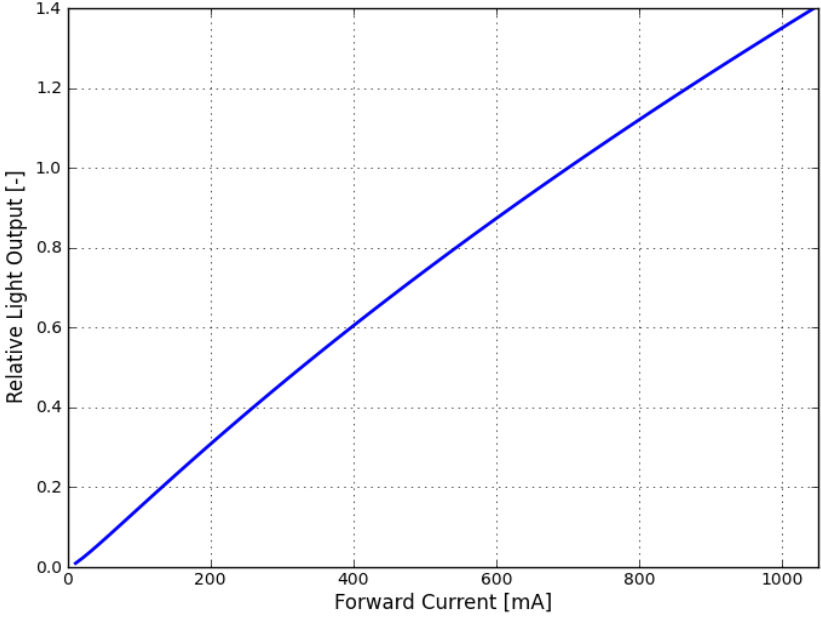

Figure 4a: Typical normalized light output vs. forward current for LXRx-Sxxx at test current, $T_j=85^\circ\text{C}$.



Figure 4b: Typical normalized light output vs. forward current for LXR-Rxxx at test current, $T_j=85^\circ\text{C}$.

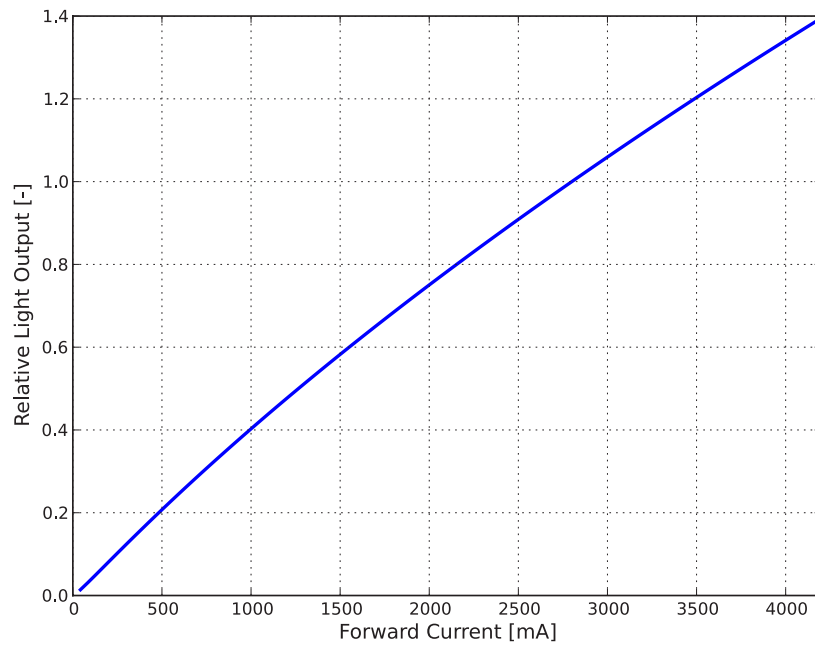

Figure 4c: Typical normalized light output vs. forward current for LXR-Qxxx at test current, $T_j=85^\circ\text{C}$.

Forward Current Characteristics

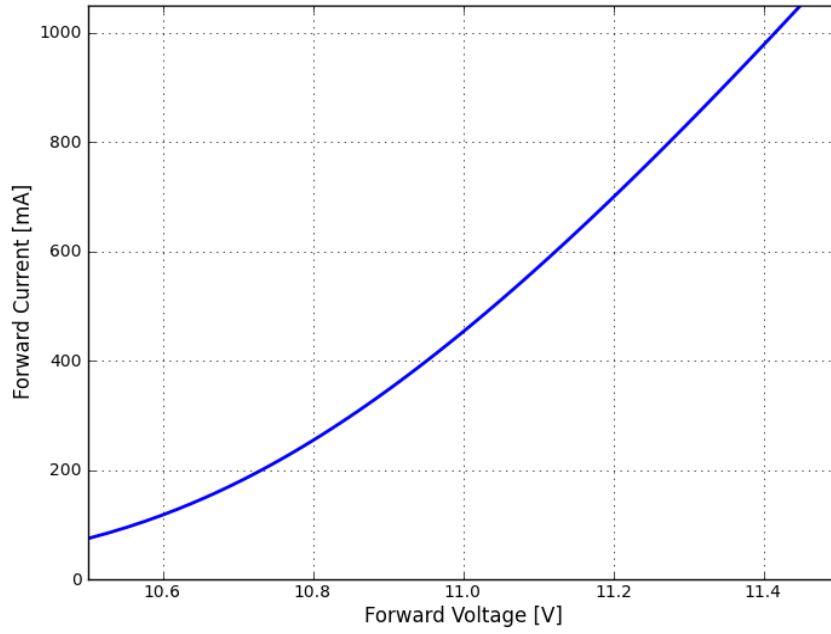

Figure 5a: Typical forward current vs. forward voltage for LXRx-Sxxx at $T_j=85^\circ\text{C}$.

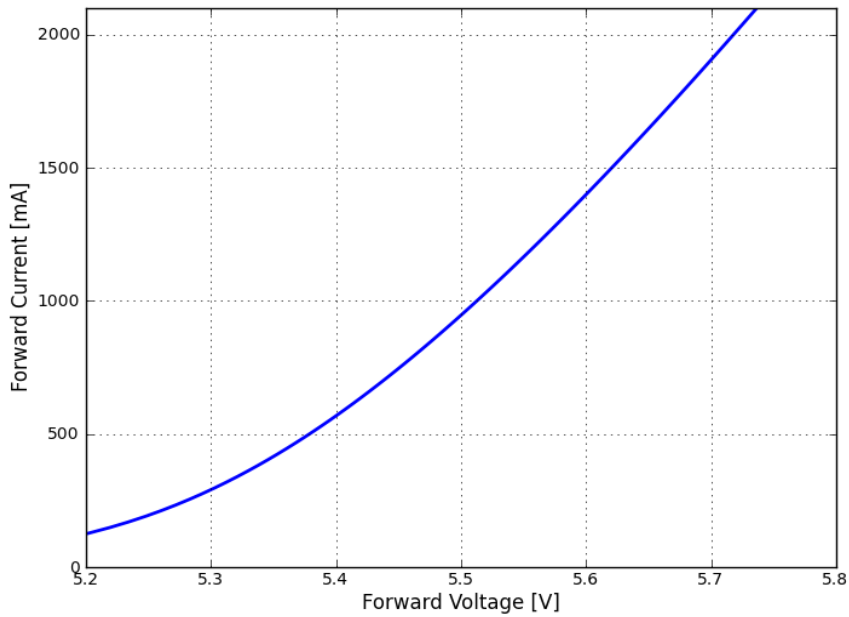

Figure 5b: Typical forward current vs. forward voltage for LXRx-Rxxx at $T_j=85^\circ\text{C}$.



Figure 5c: Typical forward current vs. forward voltage for LXRx-Qxxx at $T_j=85^\circ\text{C}$.

Radiation Pattern Characteristics



Figure 6: Typical radiation pattern for LXRx-xxxx at test current, $T_j=85^\circ\text{C}$.

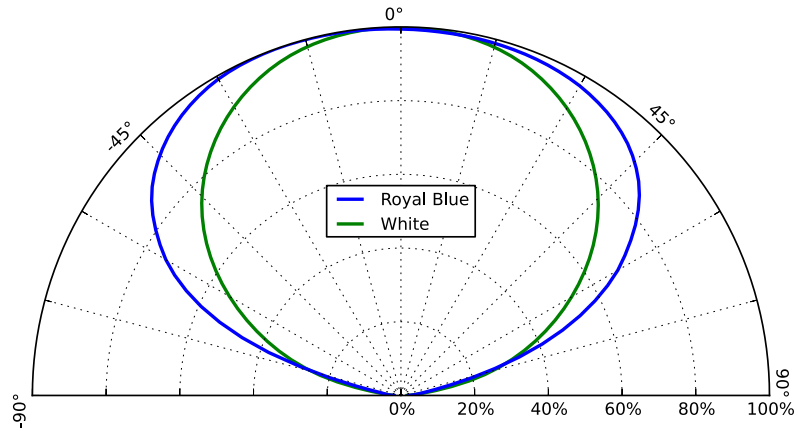

Figure 7: Typical polar radiation pattern for LXRx-xxxx at test current, $T_j=85^\circ\text{C}$.

Product Bin and Labeling Definitions

Decoding Product Bin Labeling

In the manufacturing of semiconductor products, there are variations in performance around the average values given in the technical datasheet. For this reason, Lumileds bins LED components for luminous flux or radiometric power, color point, peak or dominant wavelength and forward voltage.

Reels with LUXEON M White LEDs are labeled using a 4-digit alphanumeric CAT code following the format below:

A B C D

- A** – designates luminous flux bin (example: M=630 to 680 lumens, T=970 to 1040 lumens)
- B** – designates color bin (example: 1=6500K, 2=5700K, 3=5000K, 5=4000K, 6=3500K, 7=3000K, 8=2700K)
- C** – designates color space (example: 5=5-step MacAdam Ellipse, 3=3-step MacAdam Ellipse)
- D** – designates forward voltage bin (example: F, G, H)

Therefore, a white LUXEON M with a lumen range of 630 to 680, color of 3000K, 5-step MacAdam ellipse and a forward voltage range of 2.63 to 2.75V for 3 volt parts has the following CAT code:

M 7 5 F

Reels of LUXEON M Royal Blue LEDs are labeled using a 3-digit alphanumeric CAT code following the format below:

A B C

- A** – designates radiometric power bin (example: B=4200 to 4400mW, D=4600 to 4800mW)
- B** – designates dominant wavelength bin (example: 5=450 to 455nm, 6=455 to 460nm)
- C** – designates forward voltage bin (example: F, G, H)

Therefore, a Royal Blue LUXEON M with a radiometric power range of 4200 to 4400mW, peak of dominant wavelength 450 to 455nm a forward voltage range of 11.50 to 11.70V for 12 volt parts has the following CAT code:

B 5 H

Luminous Flux Bins

Table 5 lists the standard photometric luminous flux bins for LUXEON M emitters. Although several bins are outlined, product availability in a particular bin varies by production run and by product performance. Not all bins are available in all CCTs.

Table 5. Luminous flux bin definitions for LUXEON M White.

BIN	LUMINOUS FLUX (lm)	
	MINIMUM	MAXIMUM
J	510	550
K	550	590
L	590	630
M	630	680
N	680	730
P	730	780
Q	780	840
R	840	900
S	900	970
T	970	1040
U	1040	1120
V	1120	1200
W	1200	1290

Notes for Table 5:

1. Lumileds maintains a tolerance of $\pm 6.5\%$ on luminous flux measurements.

Radiometric Power Bins

Table 6. Radiometric power bin definitions for LUXEON M Royal Blue.

BIN	RADIOMETRIC POWER (mW)	
	MINIMUM	MAXIMUM
A	4000	4200
B	4200	4400
C	4400	4600
D	4600	4800
E	4800	5000

Notes for Table 6:

1. Lumileds maintains a tolerance of $\pm 6.5\%$ on radiometric power measurements.

Color Bin Definition

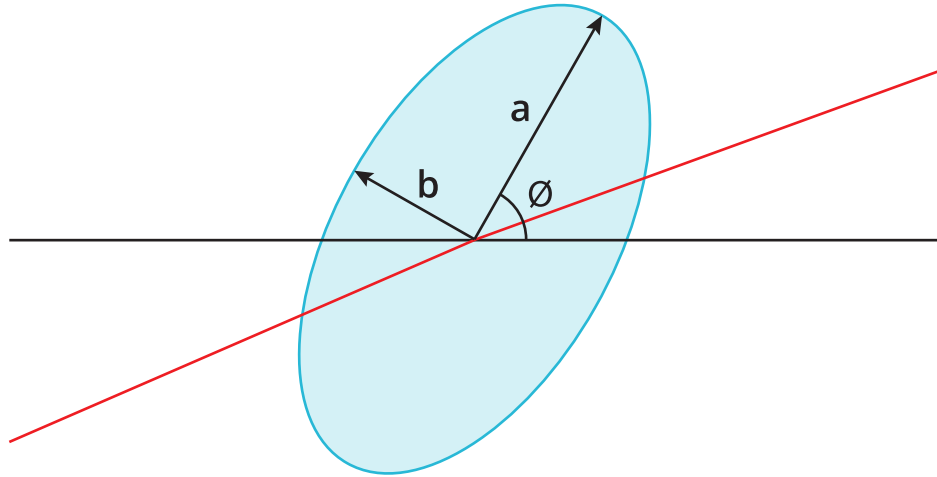

Figure 8: 3- and 5-step MacAdam ellipse illustration for Table 7.

Table 7. 3- and 5-step MacAdam ellipse color bin definitions for LUXEON M.

NOMINAL CCT	COLOR SPACE	CENTER POINT (cx, cy)	MAJOR AXIS, a	MINOR AXIS, b	ELLIPSE ROTATION ANGLE, Ø
2700K	Single 3-step MacAdam ellipse	0.4578, 0.4101	0.00810	0.00420	53.70
3000K	Single 3-step MacAdam ellipse	0.4338, 0.4030	0.00834	0.00408	53.22
3500K	Single 3-step MacAdam ellipse	0.4073, 0.3917	0.00927	0.00414	54.00
4000K	Single 3-step MacAdam ellipse	0.3818, 0.3797	0.00939	0.00402	53.72
5000K	Single 3-step MacAdam ellipse	0.3447, 0.3553	0.00822	0.00354	59.62
3000K	Single 5-step MacAdam ellipse	0.4338, 0.4030	0.01390	0.00680	53.22
4000K	Single 5-step MacAdam ellipse	0.3818, 0.3797	0.01565	0.00670	53.72
5000K	Single 5-step MacAdam ellipse	0.3447, 0.3553	0.01370	0.00590	59.62
5700K	Single 5-step MacAdam ellipse	0.3287, 0.3417	0.01243	0.00533	59.09
6500K	Single 5-step MacAdam ellipse	0.3123, 0.3282	0.01115	0.00475	58.57

Notes for Table 7:

1. Lumileds maintains a tolerance of ± 0.005 on x and y coordinates in the CIE 1931 color space.

Dominant Wavelength Bins

Table 8. Dominant wavelength bins for LUXEON M Royal Blue.

BIN	DOMINANT WAVELENGTH (nm) ⁽¹⁾	
	MINIMUM	MAXIMUM
4	445	450
5	450	455
6	455	460

Notes for Table 8:

1. Lumileds maintains a tolerance of ± 0.5 nm on dominant wavelength measurements.

Forward Voltage Bins

Table 9. Forward voltage bin definitions for LUXEON M.

PART NUMBER	BIN	FORWARD VOLTAGE (V) ⁽¹⁾	
		MINIMUM	MAXIMUM
LXRx-SWxx and LXR0-SR00	F	10.50	11.00
	G	11.00	11.50
	H	11.50	11.70
LXRx-RWxx and LXR0-RR00	F	5.25	5.50
	G	5.50	5.75
	H	5.75	6.00
LXRx-QWxx and LXR0-QR00	F	2.63	2.75
	G	2.75	2.88
	H	2.88	3.00

Notes for Table 9:

1. Lumileds maintains a tolerance of $\pm 0.06V$ on forward voltage measurements.

Mechanical Dimensions



Figure 9: Mechanical dimensions for LUXEON M.

Notes for Figure 9:

1. Drawings are not to scale.
2. All dimensions are in millimeters.

Reflow Soldering Guidelines

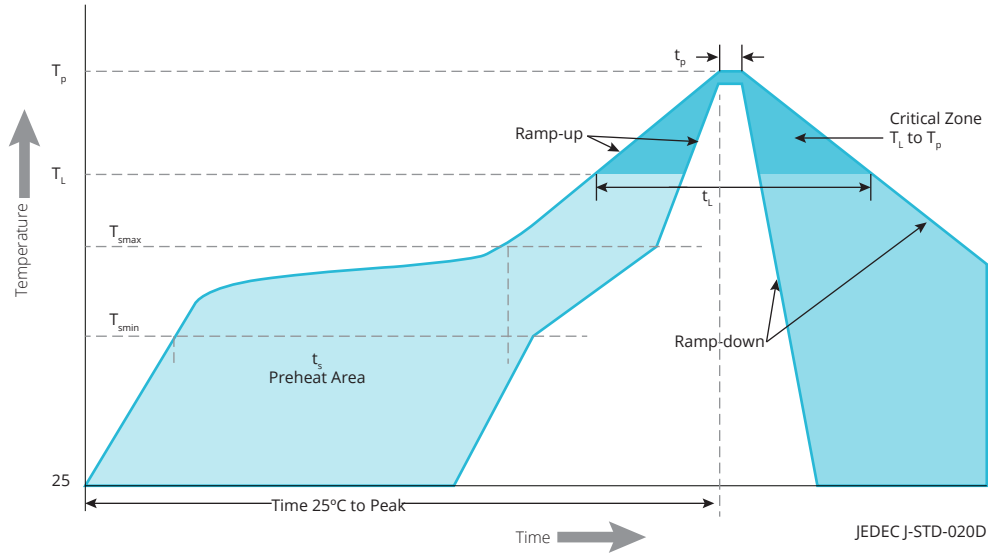

Figure 10: Visualization of the acceptable reflow temperature profile as specified in Table 10.

Table 10. Reflow profile characteristics for LUXEON M.

PROFILE FEATURE	LEAD-FREE ASSEMBLY
Preheat Minimum Temperature (T_{smin})	150°C
Preheat Maximum Temperature (T_{smax})	200°C
Preheat Time (t_{smin} to t_{smax})	60 to 120 seconds
Ramp-Up Rate (T_{smax} to T_p)	3°C / second maximum
Liquidus Temperature (T_L)	217°C
Time Maintained Above Temperature T_L (t_t)	60 to 150 seconds
Peak / Classification Temperature (T_p)	260°C
Time Within 5°C of Actual Temperature (t_p)	20 to 40 seconds
Ramp-Down Rate	6°C / second maximum
Time 25°C to Peak Temperature	8 minutes maximum

Notes for Table 10:

1. All temperatures refer to the application Printed Circuit Board (PCB), measured on the surface adjacent to the package body.

JEDEC Moisture Sensitivity

Table 11. Moisture sensitivity levels for LUXEON M.

LEVEL	FLOOR LIFE		SOAK REQUIREMENTS STANDARD	
	TIME	CONDITIONS	TIME	CONDITIONS
1	Unlimited	≤30°C / 85% RH	168 Hours +5 / -0	85°C / 85% RH

Solder Pad Design

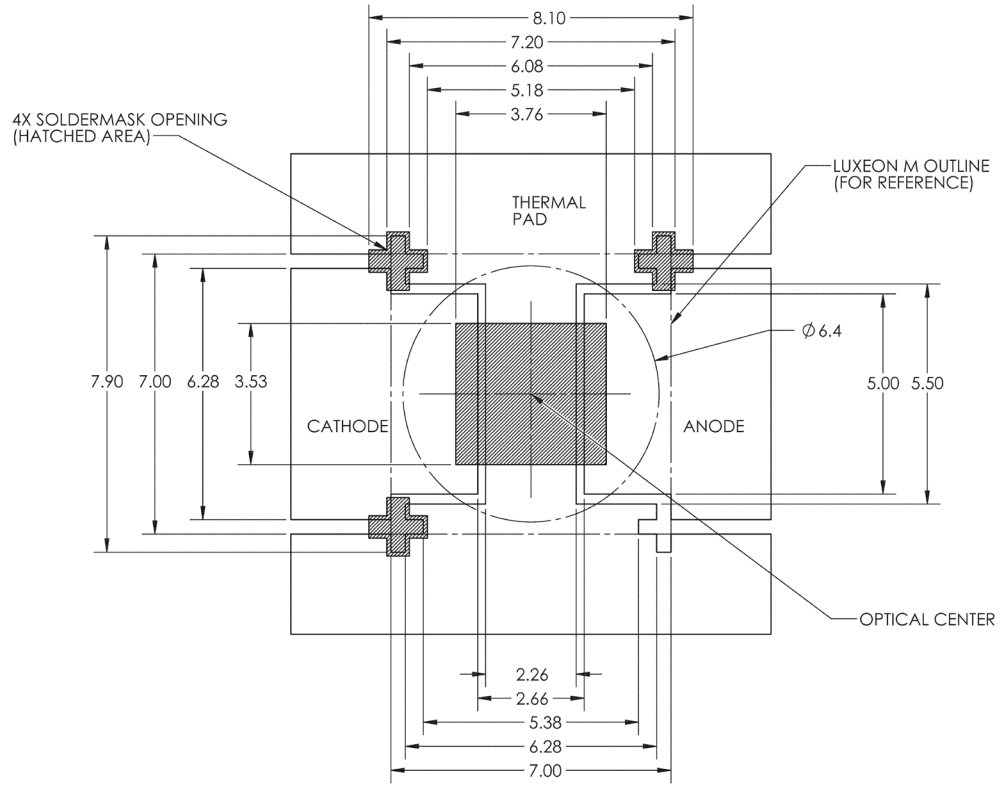

Figure 11: Recommended PCB solder pad layout for LUXEON M.

- Notes for Figure 11:
1. Drawings are not to scale.
 2. All dimensions are in millimeters.

Packaging Information

Pocket Tape Dimensions



Figure 12: Pocket Tape dimensions for LUXEON M.

Notes for Figure 12:

1. Drawings are not to scale.
2. All dimensions are in millimeters.

Reel Dimensions

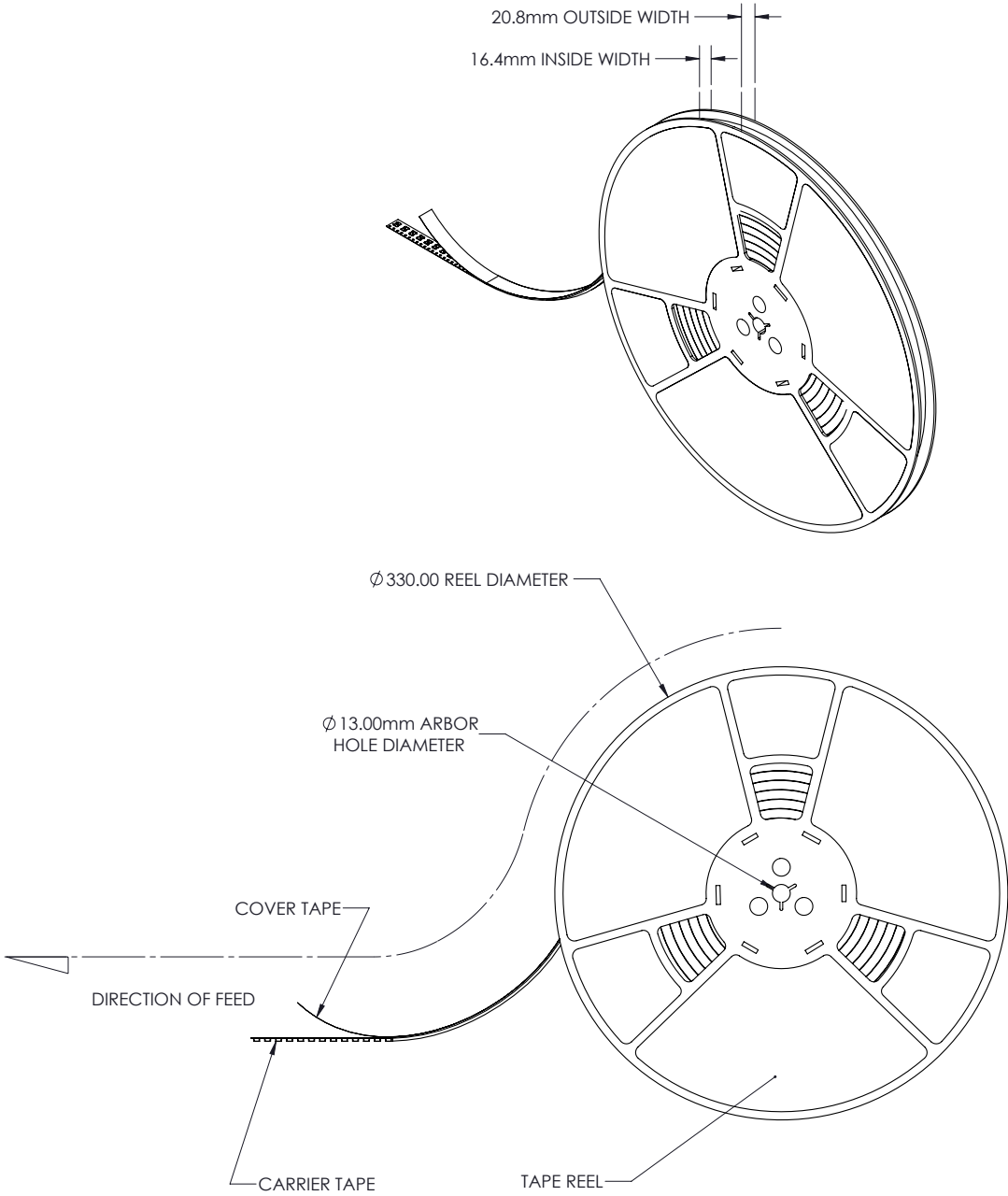

Figure 13: Reel dimensions for LUXEON M.

Notes for Figure 13:
1. Drawings are not to scale.
2. All dimensions are in millimeters.

About Lumileds

Lumileds is the light engine leader, delivering innovation, quality and reliability.

For 100 years, Lumileds commitment to innovation has helped customers pioneer breakthrough products in the automotive, consumer and illumination markets.

Lumileds is shaping the future of light with our LEDs and automotive lamps, and helping our customers illuminate how people see the world around them.

To learn more about our portfolio of light engines, visit lumileds.com.



©2015 Lumileds Holding B.V. All rights reserved.
LUXEON is a registered trademark of the Lumileds Holding B.V.
in the United States and other countries.

lumileds.com

Neither Lumileds Holding B.V. nor its affiliates shall be liable for any kind of loss of data or any other damages, direct, indirect or consequential, resulting from the use of the provided information and data. Although Lumileds Holding B.V. and/or its affiliates have attempted to provide the most accurate information and data, the materials and services information and data are provided "as is," and neither Lumileds Holding B.V. nor its affiliates warrants or guarantees the contents and correctness of the provided information and data. Lumileds Holding B.V. and its affiliates reserve the right to make changes without notice. You as user agree to this disclaimer and user agreement with the download or use of the provided materials, information and data.

DS103 LUXEON M
Product Datasheet 20150820



Компания «ЭлектроПласт» предлагает заключение долгосрочных отношений при поставках импортных электронных компонентов на взаимовыгодных условиях!

Наши преимущества:

- Оперативные поставки широкого спектра электронных компонентов отечественного и импортного производства напрямую от производителей и с крупнейших мировых складов;
- Поставка более 17-ти миллионов наименований электронных компонентов;
- Поставка сложных, дефицитных, либо снятых с производства позиций;
- Оперативные сроки поставки под заказ (от 5 рабочих дней);
- Экспресс доставка в любую точку России;
- Техническая поддержка проекта, помощь в подборе аналогов, поставка прототипов;
- Система менеджмента качества сертифицирована по Международному стандарту ISO 9001;
- Лицензия ФСБ на осуществление работ с использованием сведений, составляющих государственную тайну;
- Поставка специализированных компонентов (Xilinx, Altera, Analog Devices, Intersil, Interpoint, Microsemi, Aeroflex, Peregrine, Syfer, Eurofarad, Texas Instrument, Miteq, Cobham, E2V, MA-COM, Hittite, Mini-Circuits, General Dynamics и др.);

Помимо этого, одним из направлений компании «ЭлектроПласт» является направление «Источники питания». Мы предлагаем Вам помощь Конструкторского отдела:

- Подбор оптимального решения, техническое обоснование при выборе компонента;
- Подбор аналогов;
- Консультации по применению компонента;
- Поставка образцов и прототипов;
- Техническая поддержка проекта;
- Защита от снятия компонента с производства.



Как с нами связаться

Телефон: 8 (812) 309 58 32 (многоканальный)

Факс: 8 (812) 320-02-42

Электронная почта: org@eplast1.ru

Адрес: 198099, г. Санкт-Петербург, ул. Калинина, дом 2, корпус 4, литера А.