

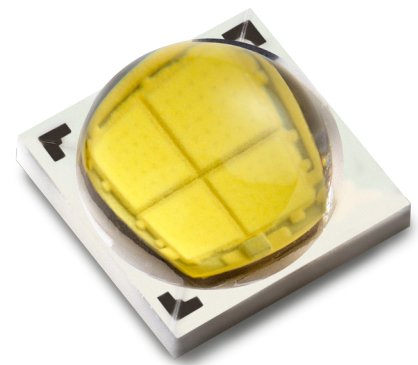

LUXEON M

Brightest, most uniform and highest efficacy multi-die emitter

LUXEON M is an illumination grade multi-die LED designed to enable outdoor and industrial applications targeting either high efficiency or low cost. With *Freedom from Binning* and leading performance, LUXEON M falls within a single 3- or 5-step MacAdam ellipse centered in ANSI to ensure color consistency from LED to LED, delivering high efficacy and high flux density from a uniform source with tight correlated color temperature control. The superior quality of light, volume of lumens, and real world efficacy enable leading performance and efficient solution development in a wide variety of lighting segments.



FEATURES AND BENEFITS

Uniform image enables tight beam control in MR16 and spotlight applications

High flux density from a 3mm² area enables reduced emitter count and compact fixture designs

11.2V, 5.6V and 2.8V package options puts high performance within reach with high efficiency and low cost drivers

Leading thermal resistance allows flexible system design to optimize for lm/\$ and lm/W

Exceeds ENERGY STAR® lumen maintenance requirements

PRIMARY APPLICATIONS

Architectural

High Bay & Low Bay

Lamps

Outdoor

Specialty Lighting

Spotlights

Table of Contents

| | |
|---|-----------|
| General Product Information | 2 |
| Product Test Conditions | 2 |
| Part Number Nomenclature | 2 |
| Lumen Maintenance | 2 |
| Environmental Compliance | 2 |
| Performance Characteristics | 3 |
| Product Selection Guide | 3 |
| Optical Characteristics | 4 |
| Electrical and Thermal Characteristics | 4 |
| Absolute Maximum Ratings | 5 |
| Operating Conditions | 5 |
| Characteristic Curves | 6 |
| Spectral Power Distribution Characteristics | 6 |
| Light Output Characteristics | 8 |
| Forward Current Characteristics | 10 |
| Radiation Pattern Characteristics | 12 |
| Product Bin and Labeling Definitions | 13 |
| Decoding Product Bin Labeling | 13 |
| Luminous Flux Bins | 14 |
| Radiometric Power Bins | 14 |
| Color Bin Definition | 15 |
| Dominant Wavelength Bins | 15 |
| Forward Voltage Bins | 16 |
| Mechanical Dimensions | 16 |
| Reflow Soldering Guidelines | 17 |
| JEDEC Moisture Sensitivity | 17 |
| Solder Pad Design | 18 |
| Packaging Information | 19 |
| Pocket Tape Dimensions | 19 |
| Reel Dimensions | 20 |

General Product Information

Product Test Conditions

LUXEON M LEDs are tested and binned with a DC drive current of 700mA for LUXEON M 12V, 1400mA for LUXEON M 6V and 2800mA for LUXEON M 3V at a junction temperature, T_j , of 85°C.

Part Number Nomenclature

Part numbers for LUXEON M follow the convention below:

L X R **A - B C D D - E E E E**

Where:

- A** – designates minimum CRI (7=70, 8=80, 9=90, 0=Royal Blue)
- B** – designates voltage (S=12V, R=6V, Q=3V)
- C** – designates color (W=White, R=Royal Blue)
- D D** – designates CCT (27=2700K, 30=3000K, 35=3500K, 40=4000K, 50=5000K, 57=5700K, 65=6500K, 00=Royal Blue)
- E E E E** – designates minimum luminous flux (optional)

Therefore, the following part number is used for a white LUXEON M 12V 3000K 80CRI:

L X R **8 - S W 3 0 - x x x x**

Lumen Maintenance

Please contact your local Sales Representative or Lumileds Technical Solutions Manager for more information about the long-term performance of this product.

Environmental Compliance

Lumileds LLC is committed to providing environmentally friendly products to the solid-state lighting market. LUXEON M is compliant to the European Union directives on the restriction of hazardous substances in electronic equipment, namely the RoHS Directive 2011/65/EU and REACH Regulation (EC) 1907/2006. Lumileds LLC will not intentionally add the following restricted materials to its products: lead, mercury, cadmium, hexavalent chromium, polybrominated biphenyls (PBB) or polybrominated diphenyl ethers (PBDE).

Performance Characteristics

Product Selection Guide

Table 1a. Product performance for LUXEON M White at test current, $T_j=85^\circ\text{C}$.

| VOLTAGE | NOMINAL CCT [2] | MINIMUM CRI | LUMINOUS FLUX [1] (lm) | | TEST CURRENT (mA) | PART NUMBER |
|---------|-----------------|-------------|------------------------|---------|-------------------|-------------|
| | | | MINIMUM | TYPICAL | | |
| 12V | 3000K | 70 | 900 | 1000 | 700 | LXR7-SW30 |
| | 4000K | 70 | 970 | 1076 | 700 | LXR7-SW40 |
| | 5000K | 70 | 1040 | 1100 | 700 | LXR7-SW50 |
| | 5700K | 70 | 1040 | 1110 | 700 | LXR7-SW57 |
| | 6500K | 70 | 1040 | 1130 | 700 | LXR7-SW65 |
| | 2700K | 80 | 730 | 800 | 700 | LXR8-SW27 |
| | 3000K | 80 | 780 | 850 | 700 | LXR8-SW30 |
| | 3500K | 80 | 780 | 870 | 700 | LXR8-SW35 |
| | 4000K | 80 | 840 | 905 | 700 | LXR8-SW40 |
| | 5000K | 80 | 840 | 920 | 700 | LXR8-SW50 |
| | 2700K | 90 | 600 | 660 | 700 | LXR9-SW27 |
| | 3000K | 90 | 640 | 736 | 700 | LXR9-SW30 |
| | 5700K | 90 | 800 | 880 | 700 | LXR9-SW57 |
| | 6V | 3000K | 70 | 900 | 1000 | 1400 |
| 4000K | | 70 | 970 | 1076 | 1400 | LXR7-RW40 |
| 5000K | | 70 | 1040 | 1100 | 1400 | LXR7-RW50 |
| 5700K | | 70 | 1040 | 1110 | 1400 | LXR7-RW57 |
| 6500K | | 70 | 1040 | 1130 | 1400 | LXR7-RW65 |
| 2700K | | 80 | 730 | 800 | 1400 | LXR8-RW27 |
| 3000K | | 80 | 780 | 850 | 1400 | LXR8-RW30 |
| 3500K | | 80 | 780 | 870 | 1400 | LXR8-RW35 |
| 4000K | | 80 | 840 | 920 | 1400 | LXR8-RW40 |
| 5000K | | 80 | 840 | 920 | 1400 | LXR8-RW50 |
| 2700K | | 90 | 600 | 660 | 1400 | LXR9-RW27 |
| 3000K | | 90 | 640 | 736 | 1400 | LXR9-RW30 |
| 5700K | | 90 | 800 | 880 | 1400 | LXR9-RW57 |
| 3V | | 3000K | 70 | 900 | 1000 | 2800 |
| | 4000K | 70 | 970 | 1076 | 2800 | LXR7-QW40 |
| | 5000K | 70 | 1040 | 1100 | 2800 | LXR7-QW50 |
| | 5700K | 70 | 1040 | 1110 | 2800 | LXR7-QW57 |
| | 6500K | 70 | 1040 | 1130 | 2800 | LXR7-QW65 |
| | 2700K | 80 | 730 | 800 | 2800 | LXR8-QW27 |
| | 3000K | 80 | 780 | 850 | 2800 | LXR8-QW30 |
| | 3500K | 80 | 780 | 870 | 2800 | LXR8-QW35 |
| | 4000K | 80 | 840 | 920 | 2800 | LXR8-QW40 |
| | 5000K | 80 | 840 | 920 | 2800 | LXR8-QW50 |
| | 2700K | 90 | 600 | 660 | 2800 | LXR9-QW27 |
| | 3000K | 90 | 640 | 736 | 2800 | LXR9-QW30 |
| | 5700K | 90 | 800 | 880 | 2800 | LXR9-QW57 |

Notes for Table 1a:

1. Lumileds maintains a tolerance of ± 2 on CRI and $\pm 6.5\%$ on luminous flux measurements.
2. Typical CRI is approximately 2 points higher than the minimum CRI specified, but this is not guaranteed.

Table 1b. Product performance for LUXEON M Royal Blue at test current, $T_j=85^\circ\text{C}$.

| VOLTAGE | DOMINANT WAVELENGTH (nm) | | RADIOMETRIC POWER (mW) | | TEST CURRENT (mA) | PART NUMBER |
|---------|--------------------------|---------|------------------------|---------|-------------------|-------------|
| | MINIMUM | MAXIMUM | MINIMUM | TYPICAL | | |
| 12V | 445 | 460 | 4200 | 4500 | 700 | LXR0-SR00 |
| 6V | 445 | 460 | 4200 | 4500 | 1400 | LXR0-RR00 |
| 3V | 445 | 460 | 4200 | 4500 | 2800 | LXR0-QR00 |

Notes for Table 1b:

1. Lumileds maintains a tolerance of $\pm 6.5\%$ on radiometric power measurements.

Optical Characteristics

Table 2. Optical characteristics for LUXEON M at test current, $T_j=85^\circ\text{C}$.

| PART NUMBER | TYPICAL TOTAL INCLUDED ANGLE ^[1] | TYPICAL VIEWING ANGLE ^[2] |
|-------------|---|--------------------------------------|
| LXR-xxxx | 140° | 120° |

Notes for Table 2:

1. Total angle at which 90% of total luminous flux is captured.
2. Viewing angle is the off axis angle from the LED centerline where the luminous intensity is ½ of the peak value.

Electrical and Thermal Characteristics

Table 3. Electrical and thermal characteristics for LUXEON M at test current, $T_j=85^\circ\text{C}$.

| PART NUMBER | FORWARD VOLTAGE (V) ^[1] | | | TYPICAL TEMPERATURE COEFFICIENT OF FORWARD VOLTAGE (mV/°C) ^[2] | TYPICAL THERMAL RESISTANCE — JUNCTION TO SOLDER PAD (°C/W) |
|-------------|------------------------------------|---------|---------|---|--|
| | MINIMUM | TYPICAL | MAXIMUM | | |
| LXR-Sxxx | 10.50 | 11.20 | 11.70 | -5.50 | 1.25 |
| LXR-Rxxx | 5.25 | 5.60 | 6.00 | -2.75 | 1.25 |
| LXR-Qxxx | 2.63 | 2.80 | 3.00 | -1.38 | 1.25 |

Notes for Table 3:

1. Lumileds maintains a tolerance of $\pm 0.06\text{V}$ on forward voltage measurements.
2. Measured between 25°C and 135°C .

Absolute Maximum Ratings

Table 4. Absolute maximum ratings for LUXEON M.

| PARAMETER | MAXIMUM PERFORMANCE |
|---|---|
| DC Forward Current at $T_j=110^{\circ}\text{C}$ ^{[1][2]} | 1200mA for LXR _x -SW _{xx} 2400mA for LXR _x -RW _{xx} 4800mA for LXR _x -QW _{xx} |
| DC Forward Current at $T_j=135^{\circ}\text{C}$ ^{[1][2]} | 1050mA for LXR _x -S _{xxx} 2100mA for LXR _x -R _{xxx} 4200mA for LXR _x -Q _{xxx} |
| Peak Pulsed Forward Current ^[3] | 1375mA for LXR _x -SW _{xx} 2750mA for LXR _x -RW _{xx} 5500mA for LXR _x -QW _{xx} 1200mA for LXR0-SR00 2400mA for LXR0-RR00 4800mA for LXR0-QR00 |
| LED Junction Temperature (DC & Pulse) | -40°C to 135°C |
| ESD Sensitivity (ANSI/ESDA/JEDEC JS-001-2012) | Class 3B |
| Operating Case Temperature ^[1] | 120°C |
| Storage Temperature | -40°C to 120°C |
| Soldering Temperature | JEDEC 020c 260°C |
| Allowable Reflow Cycles | 3 |
| Reverse Voltage (V_{reverse}) | LUXEON LEDs are not designed to be driven in reverse bias |

Notes for 4:

- See Figure 1 for more details on the maximum permissible operating conditions for LUXEON M White.
- Residual periodic variations due to power conversion from alternating current (AC) to direct current (DC), also called "ripple", are acceptable if the following conditions are met:
 - The frequency of the ripple current is 100Hz or higher
 - The average current for each cycle does not exceed the maximum allowable DC forward current at this junction temperature
 - The maximum amplitude of the ripple does not exceed 15% of the maximum allowable DC forward current at this junction temperature
- At 10% duty cycle with pulse width of 10ms.

Operating Conditions

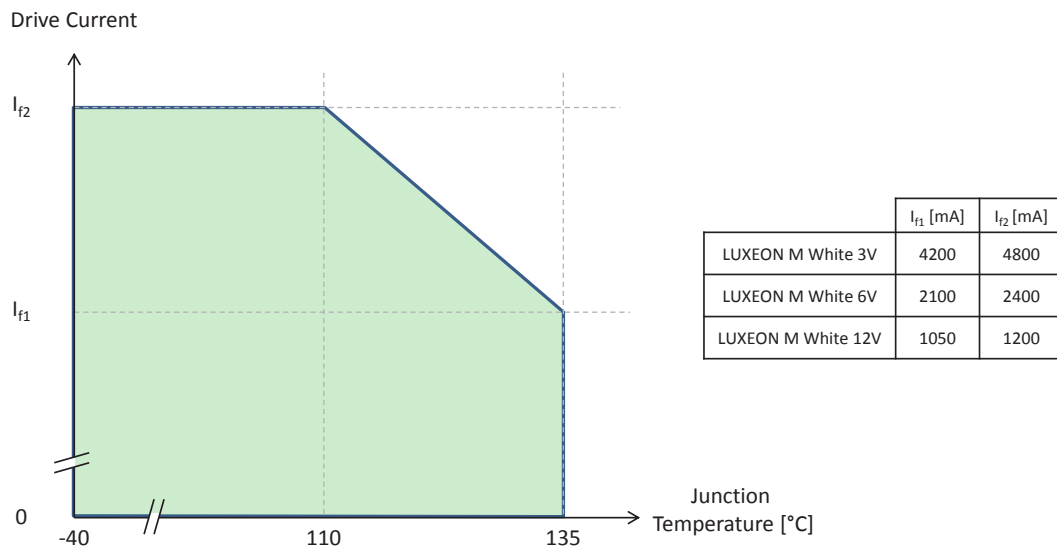

Figure 1: Maximum permissible operating conditions for LUXEON M White.

Notes for Figure 1:

- The green shaded area in this graph reflects the maximum permissible operating conditions for LUXEON M White.

Characteristic Curves

Spectral Power Distribution Characteristics

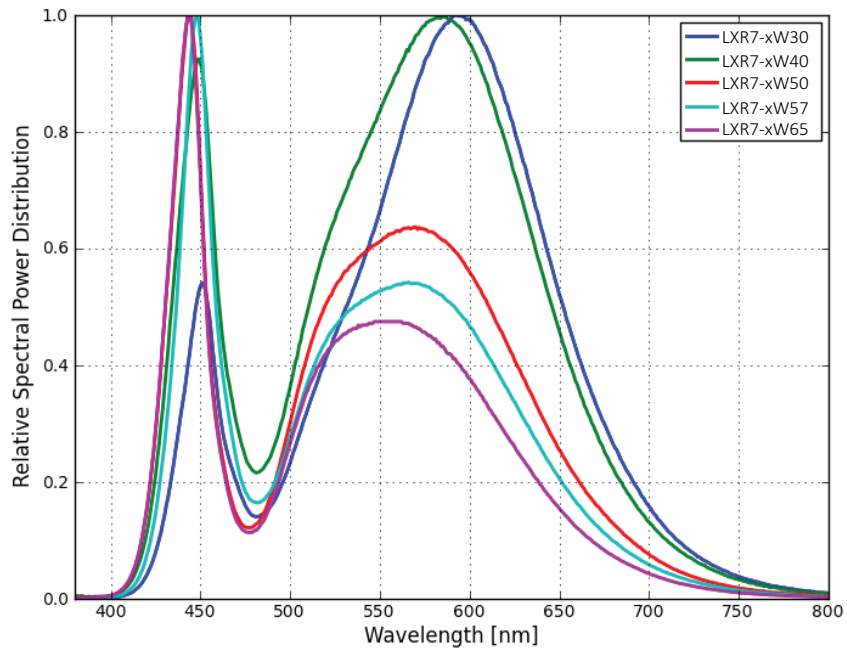

Figure 2a: Typical normalized power vs. wavelength for LXR7-xWxx at test current, $T_j=85^\circ\text{C}$.

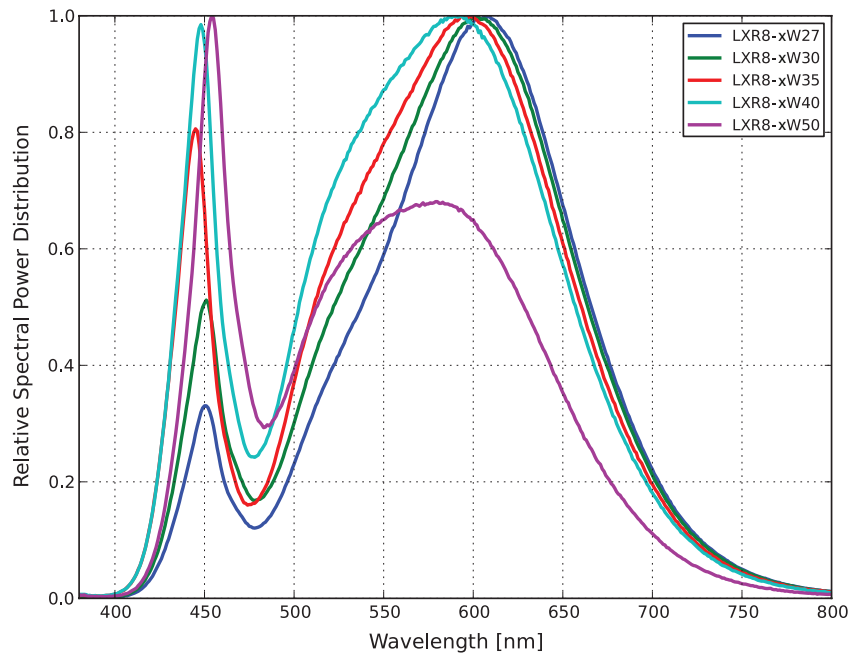

Figure 2b: Typical normalized power vs. wavelength for LXR8-xWxx at test current, $T_j=85^\circ\text{C}$.

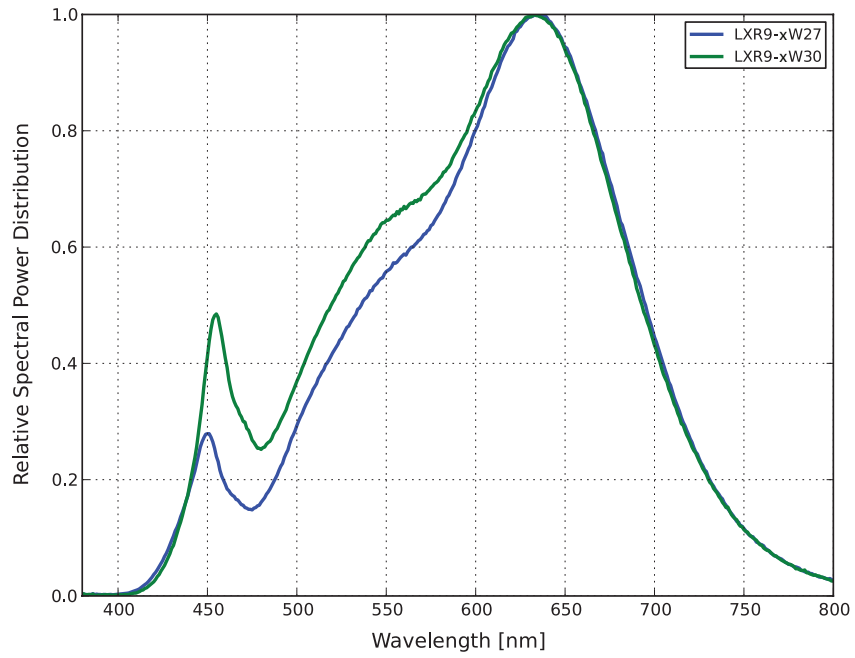

Figure 2c: Typical normalized power vs. wavelength for LXR9-xWxx at test current, $T_j=85^\circ\text{C}$.

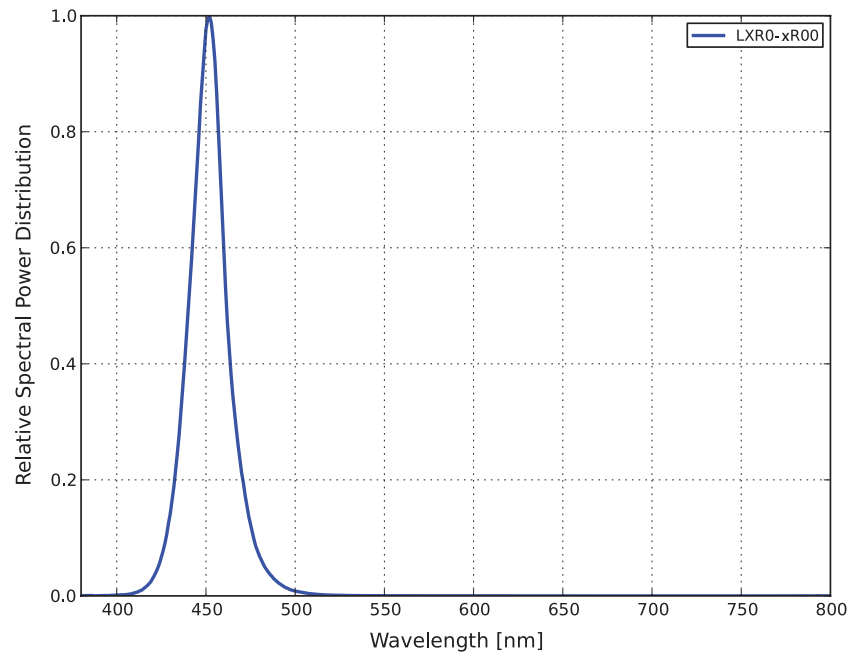

Figure 2d: Typical normalized power vs. wavelength for LXR0-xR00 at test current, $T_j=85^\circ\text{C}$.

Light Output Characteristics

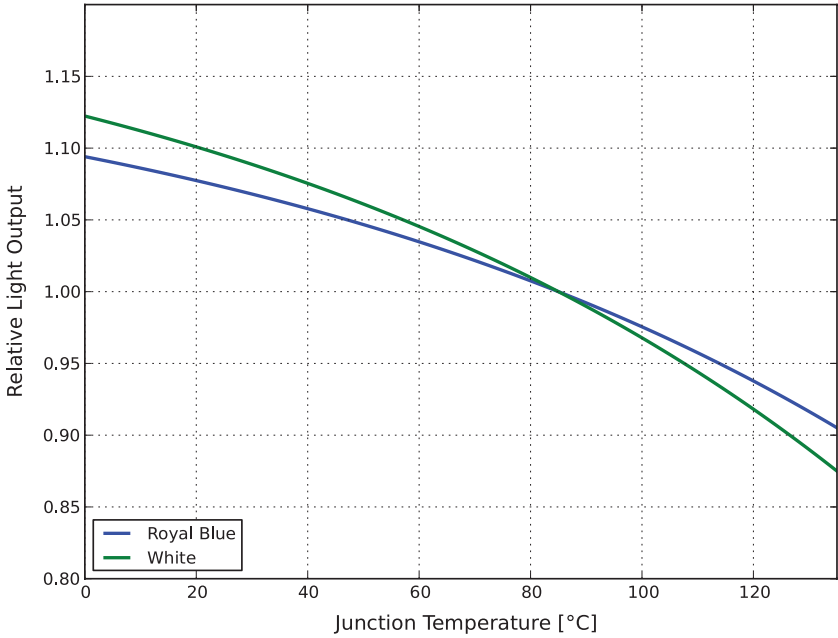

Figure 3: Typical normalized light output vs. junction temperature for LXR_x-xxxx at test current, T_j=85°C.

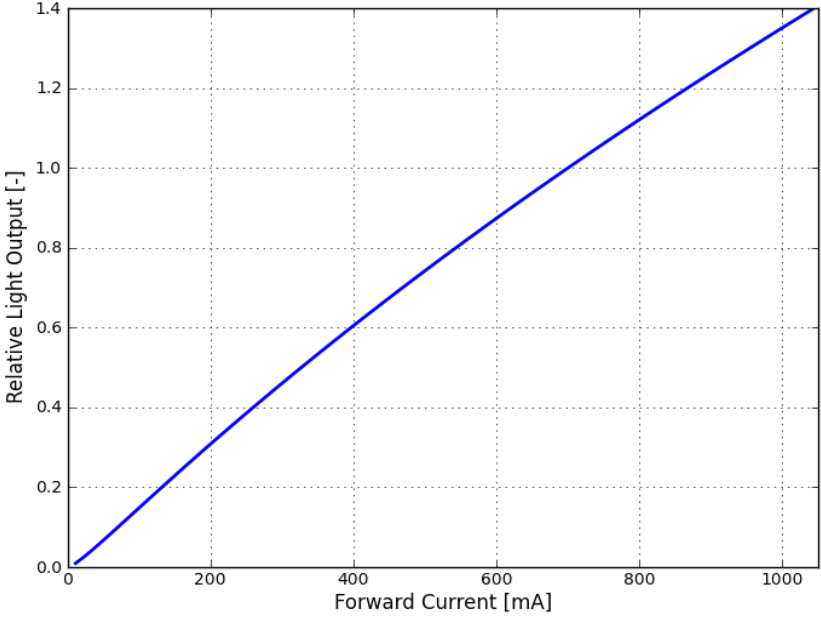

Figure 4a: Typical normalized light output vs. forward current for LXR_x-Sxxx at test current, T_j=85°C.

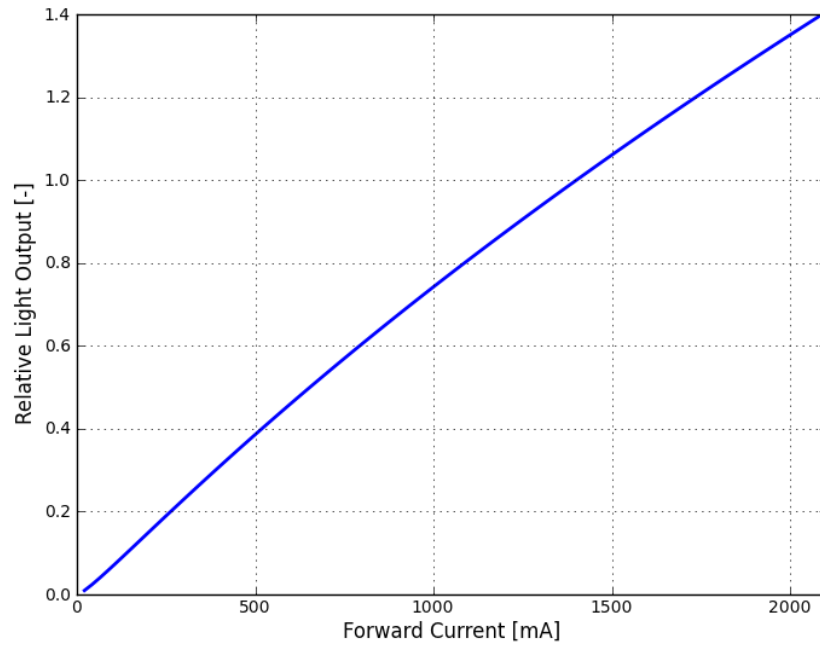

Figure 4b: Typical normalized light output vs. forward current for LXR-Rxxx at test current, $T_j=85^\circ\text{C}$.

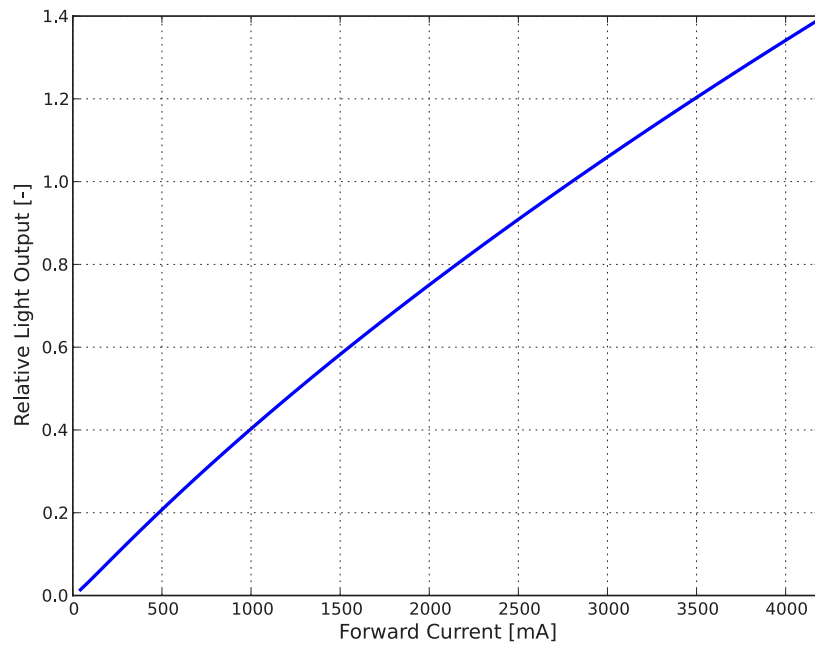

Figure 4c: Typical normalized light output vs. forward current for LXR-Qxxx at test current, $T_j=85^\circ\text{C}$.

Forward Current Characteristics

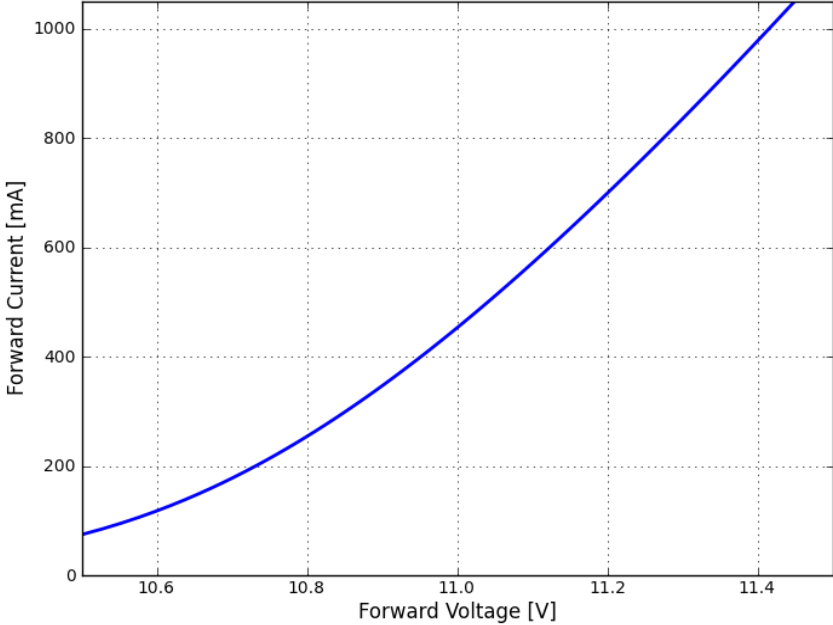

Figure 5a: Typical forward current vs. forward voltage for LXRx-Sxxx at $T_j=85^\circ\text{C}$.

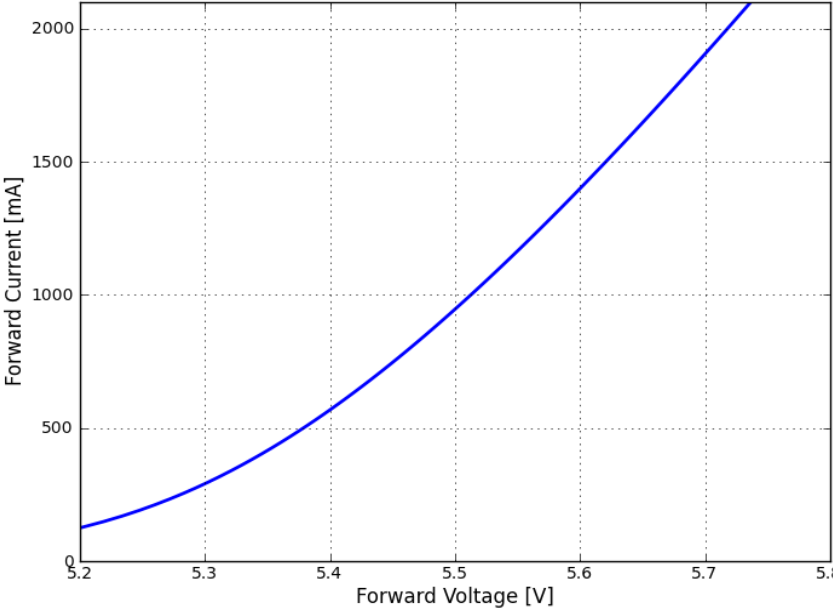

Figure 5b: Typical forward current vs. forward voltage for LXRx-Rxxx at $T_j=85^\circ\text{C}$.

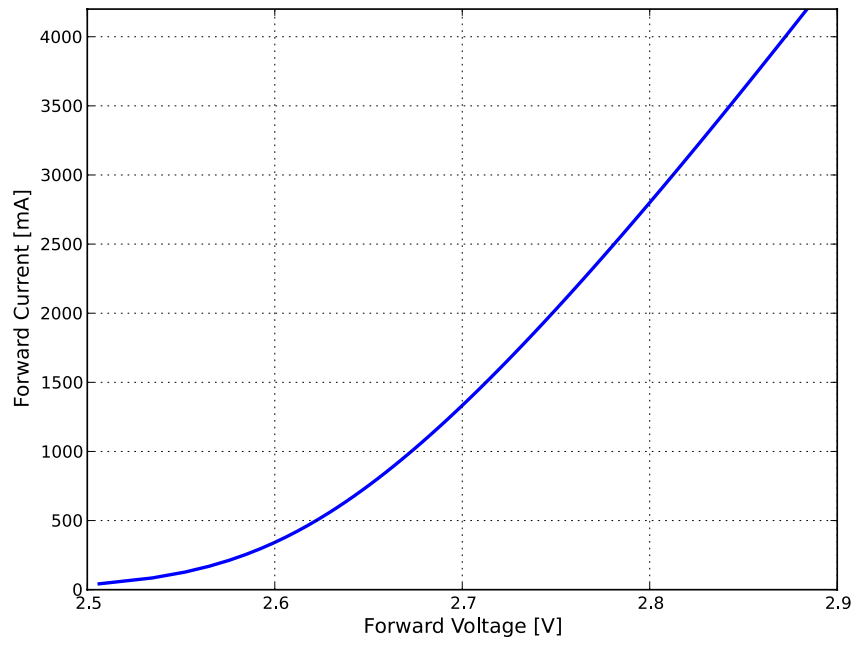

Figure 5c: Typical forward current vs. forward voltage for LXRx-Qxxx at $T_j=85^{\circ}\text{C}$.

Radiation Pattern Characteristics

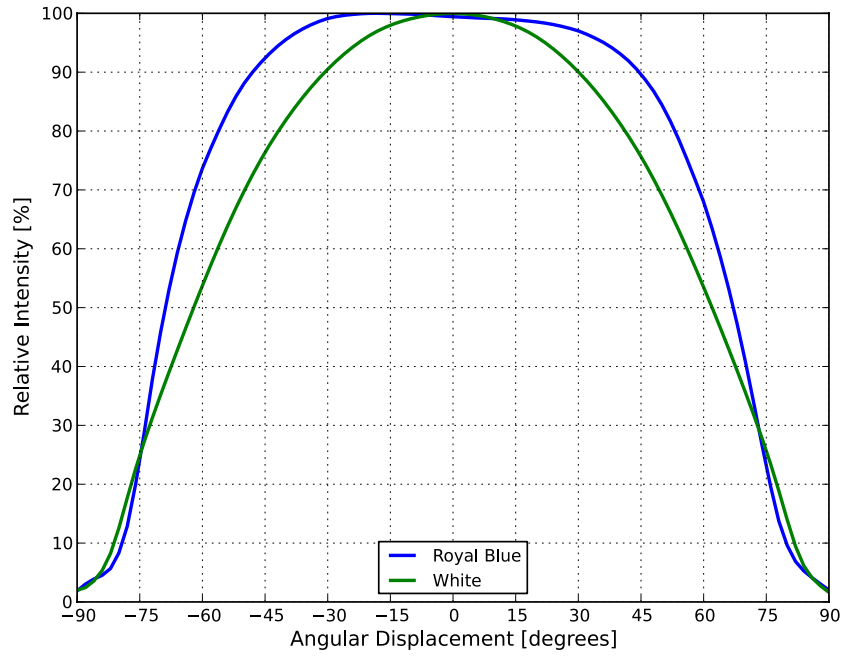

Figure 6: Typical radiation pattern for LXRx-xxxx at test current, $T_j=85^\circ\text{C}$.

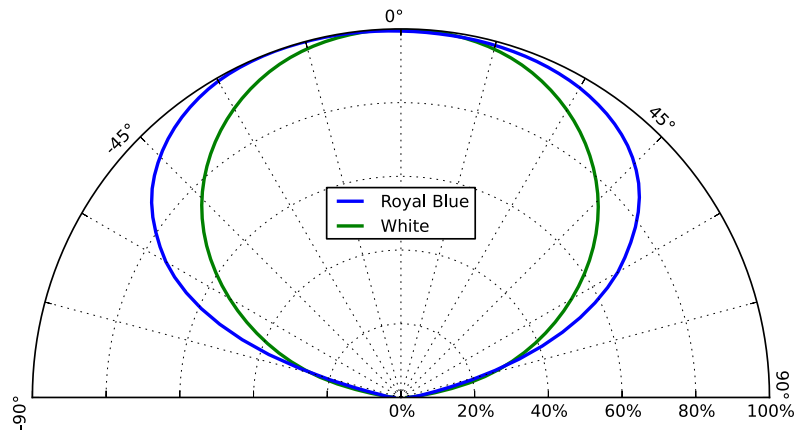

Figure 7: Typical polar radiation pattern for LXRx-xxxx at test current, $T_j=85^\circ\text{C}$.

Product Bin and Labeling Definitions

Decoding Product Bin Labeling

In the manufacturing of semiconductor products, there are variations in performance around the average values given in the technical datasheet. For this reason, Lumileds bins LED components for luminous flux or radiometric power, color point, peak or dominant wavelength and forward voltage.

Reels with LUXEON M White LEDs are labeled using a 4-digit alphanumeric CAT code following the format below:

A B C D

- A** – designates luminous flux bin (example: M=630 to 680 lumens, T=970 to 1040 lumens)
- B** – designates color bin (example: 1=6500K, 2=5700K, 3=5000K, 5=4000K, 6=3500K, 7=3000K, 8=2700K)
- C** – designates color space (example: 5=5-step MacAdam Ellipse, 3=3-step MacAdam Ellipse)
- D** – designates forward voltage bin (example: F, G, H)

Therefore, a white LUXEON M with a lumen range of 630 to 680, color of 3000K, 5-step MacAdam ellipse and a forward voltage range of 2.63 to 2.75V for 3 volt parts has the following CAT code:

M 7 5 F

Reels of LUXEON M Royal Blue LEDs are labeled using a 3-digit alphanumeric CAT code following the format below:

A B C

- A** – designates radiometric power bin (example: B=4200 to 4400mW, D=4600 to 4800mW)
- B** – designates dominant wavelength bin (example: 5=450 to 455nm, 6=455 to 460nm)
- C** – designates forward voltage bin (example: F, G, H)

Therefore, a Royal Blue LUXEON M with a radiometric power range of 4200 to 4400mW, peak of dominant wavelength 450 to 455nm a forward voltage range of 11.50 to 11.70V for 12 volt parts has the following CAT code:

B 5 H

Luminous Flux Bins

Table 5 lists the standard photometric luminous flux bins for LUXEON M emitters. Although several bins are outlined, product availability in a particular bin varies by production run and by product performance. Not all bins are available in all CCTs.

Table 5. Luminous flux bin definitions for LUXEON M White.

| BIN | LUMINOUS FLUX (lm) | |
|-----|--------------------|---------|
| | MINIMUM | MAXIMUM |
| J | 510 | 550 |
| K | 550 | 590 |
| L | 590 | 630 |
| M | 630 | 680 |
| N | 680 | 730 |
| P | 730 | 780 |
| Q | 780 | 840 |
| R | 840 | 900 |
| S | 900 | 970 |
| T | 970 | 1040 |
| U | 1040 | 1120 |
| V | 1120 | 1200 |
| W | 1200 | 1290 |

Notes for Table 5:

1. Lumileds maintains a tolerance of $\pm 6.5\%$ on luminous flux measurements.

Radiometric Power Bins

Table 6. Radiometric power bin definitions for LUXEON M Royal Blue.

| BIN | RADIOMETRIC POWER (mW) | |
|-----|------------------------|---------|
| | MINIMUM | MAXIMUM |
| A | 4000 | 4200 |
| B | 4200 | 4400 |
| C | 4400 | 4600 |
| D | 4600 | 4800 |
| E | 4800 | 5000 |

Notes for Table 6:

1. Lumileds maintains a tolerance of $\pm 6.5\%$ on radiometric power measurements.

Color Bin Definition

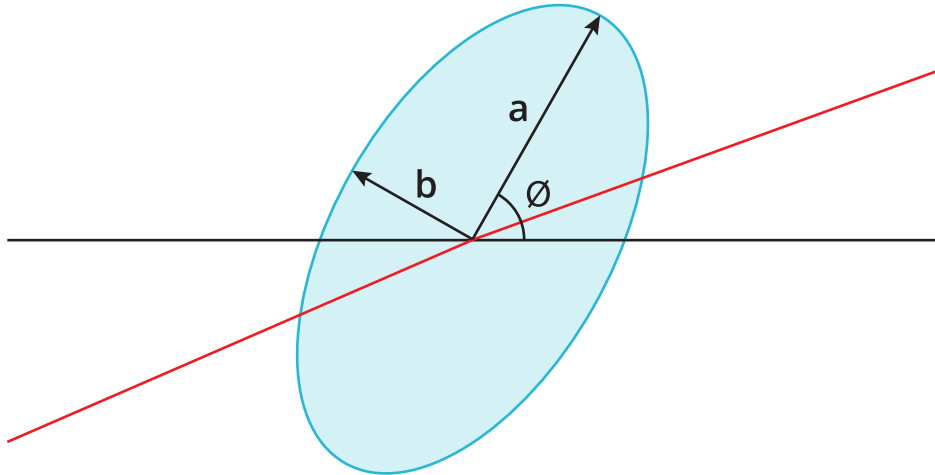

Figure 8: 3- and 5-step MacAdam ellipse illustration for Table 7.

Table 7. 3- and 5-step MacAdam ellipse color bin definitions for LUXEON M.

| NOMINAL CCT | COLOR SPACE | CENTER POINT (cx, cy) | MAJOR AXIS, a | MINOR AXIS, b | ELLIPSE ROTATION ANGLE, Ø |
|-------------|-------------------------------|-----------------------|---------------|---------------|---------------------------|
| 2700K | Single 3-step MacAdam ellipse | 0.4578, 0.4101 | 0.00810 | 0.00420 | 53.70 |
| 3000K | Single 3-step MacAdam ellipse | 0.4338, 0.4030 | 0.00834 | 0.00408 | 53.22 |
| 3500K | Single 3-step MacAdam ellipse | 0.4073, 0.3917 | 0.00927 | 0.00414 | 54.00 |
| 4000K | Single 3-step MacAdam ellipse | 0.3818, 0.3797 | 0.00939 | 0.00402 | 53.72 |
| 5000K | Single 3-step MacAdam ellipse | 0.3447, 0.3553 | 0.00822 | 0.00354 | 59.62 |
| 3000K | Single 5-step MacAdam ellipse | 0.4338, 0.4030 | 0.01390 | 0.00680 | 53.22 |
| 4000K | Single 5-step MacAdam ellipse | 0.3818, 0.3797 | 0.01565 | 0.00670 | 53.72 |
| 5000K | Single 5-step MacAdam ellipse | 0.3447, 0.3553 | 0.01370 | 0.00590 | 59.62 |
| 5700K | Single 5-step MacAdam ellipse | 0.3287, 0.3417 | 0.01243 | 0.00533 | 59.09 |
| 6500K | Single 5-step MacAdam ellipse | 0.3123, 0.3282 | 0.01115 | 0.00475 | 58.57 |

Notes for Table 7:

1. Lumileds maintains a tolerance of ± 0.005 on x and y coordinates in the CIE 1931 color space.

Dominant Wavelength Bins

Table 8. Dominant wavelength bins for LUXEON M Royal Blue.

| BIN | DOMINANT WAVELENGTH (nm) ⁽¹⁾ | |
|-----|---|---------|
| | MINIMUM | MAXIMUM |
| 4 | 445 | 450 |
| 5 | 450 | 455 |
| 6 | 455 | 460 |

Notes for Table 8:

1. Lumileds maintains a tolerance of ± 0.5 nm on dominant wavelength measurements.

Forward Voltage Bins

Table 9. Forward voltage bin definitions for LUXEON M.

| PART NUMBER | BIN | FORWARD VOLTAGE (V) ⁽¹⁾ | |
|----------------------------|-----|------------------------------------|---------|
| | | MINIMUM | MAXIMUM |
| LXRx-SWxx and LXR0-SR00 | F | 10.50 | 11.00 |
| | G | 11.00 | 11.50 |
| | H | 11.50 | 11.70 |
| LXRx-RWxx and LXR0-RR00 | F | 5.25 | 5.50 |
| | G | 5.50 | 5.75 |
| | H | 5.75 | 6.00 |
| LXRx-QWxx and LXR0-QR00 | F | 2.63 | 2.75 |
| | G | 2.75 | 2.88 |
| | H | 2.88 | 3.00 |

Notes for Table 9:

1. Lumileds maintains a tolerance of $\pm 0.06V$ on forward voltage measurements.

Mechanical Dimensions

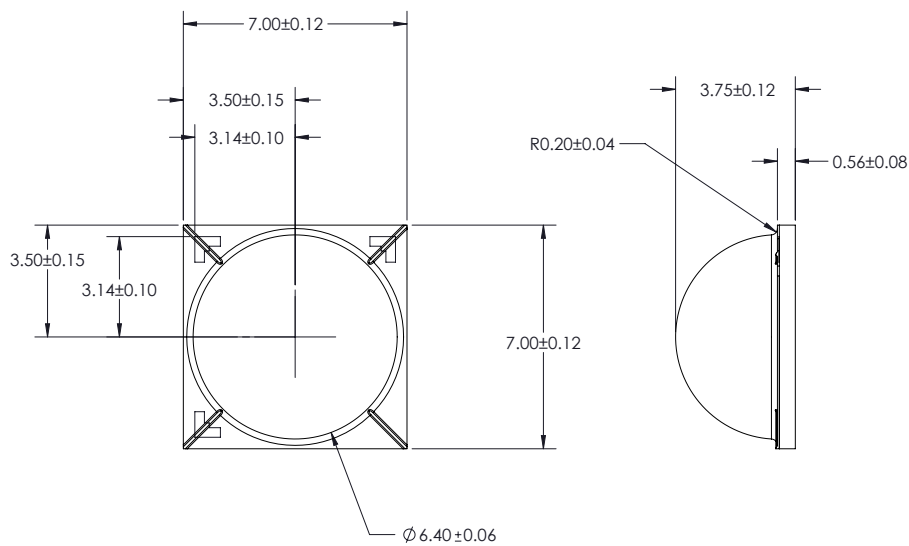

Figure 9: Mechanical dimensions for LUXEON M.

Notes for Figure 9:

1. Drawings are not to scale.
2. All dimensions are in millimeters.

Reflow Soldering Guidelines

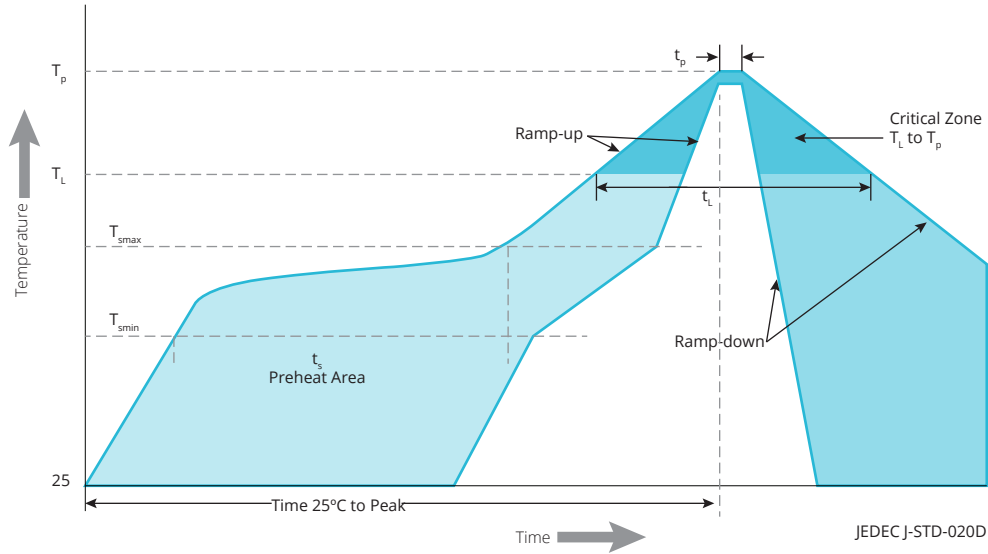

Figure 10: Visualization of the acceptable reflow temperature profile as specified in Table 10.

Table 10. Reflow profile characteristics for LUXEON M.

| PROFILE FEATURE | LEAD-FREE ASSEMBLY |
|---|----------------------|
| Preheat Minimum Temperature (T_{smin}) | 150°C |
| Preheat Maximum Temperature (T_{smax}) | 200°C |
| Preheat Time (t_{smin} to t_{smax}) | 60 to 120 seconds |
| Ramp-Up Rate (T_{smax} to T_p) | 3°C / second maximum |
| Liquidus Temperature (T_L) | 217°C |
| Time Maintained Above Temperature T_L (t_t) | 60 to 150 seconds |
| Peak / Classification Temperature (T_p) | 260°C |
| Time Within 5°C of Actual Temperature (t_p) | 20 to 40 seconds |
| Ramp-Down Rate | 6°C / second maximum |
| Time 25°C to Peak Temperature | 8 minutes maximum |

Notes for Table 10:

1. All temperatures refer to the application Printed Circuit Board (PCB), measured on the surface adjacent to the package body.

JEDEC Moisture Sensitivity

Table 11. Moisture sensitivity levels for LUXEON M.

| LEVEL | FLOOR LIFE | | SOAK REQUIREMENTS STANDARD | |
|-------|------------|----------------|----------------------------|---------------|
| | TIME | CONDITIONS | TIME | CONDITIONS |
| 1 | Unlimited | ≤30°C / 85% RH | 168 Hours +5 / -0 | 85°C / 85% RH |

Solder Pad Design

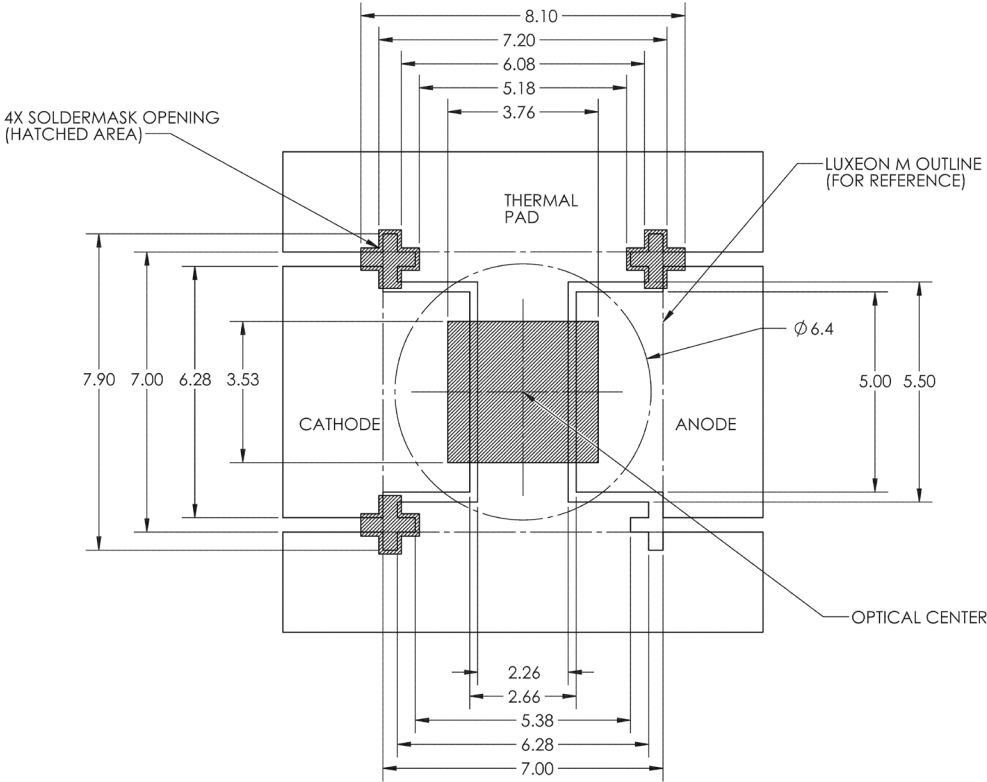

Figure 11: Recommended PCB solder pad layout for LUXEON M.

- Notes for Figure 11:
1. Drawings are not to scale.
 2. All dimensions are in millimeters.

Packaging Information

Pocket Tape Dimensions

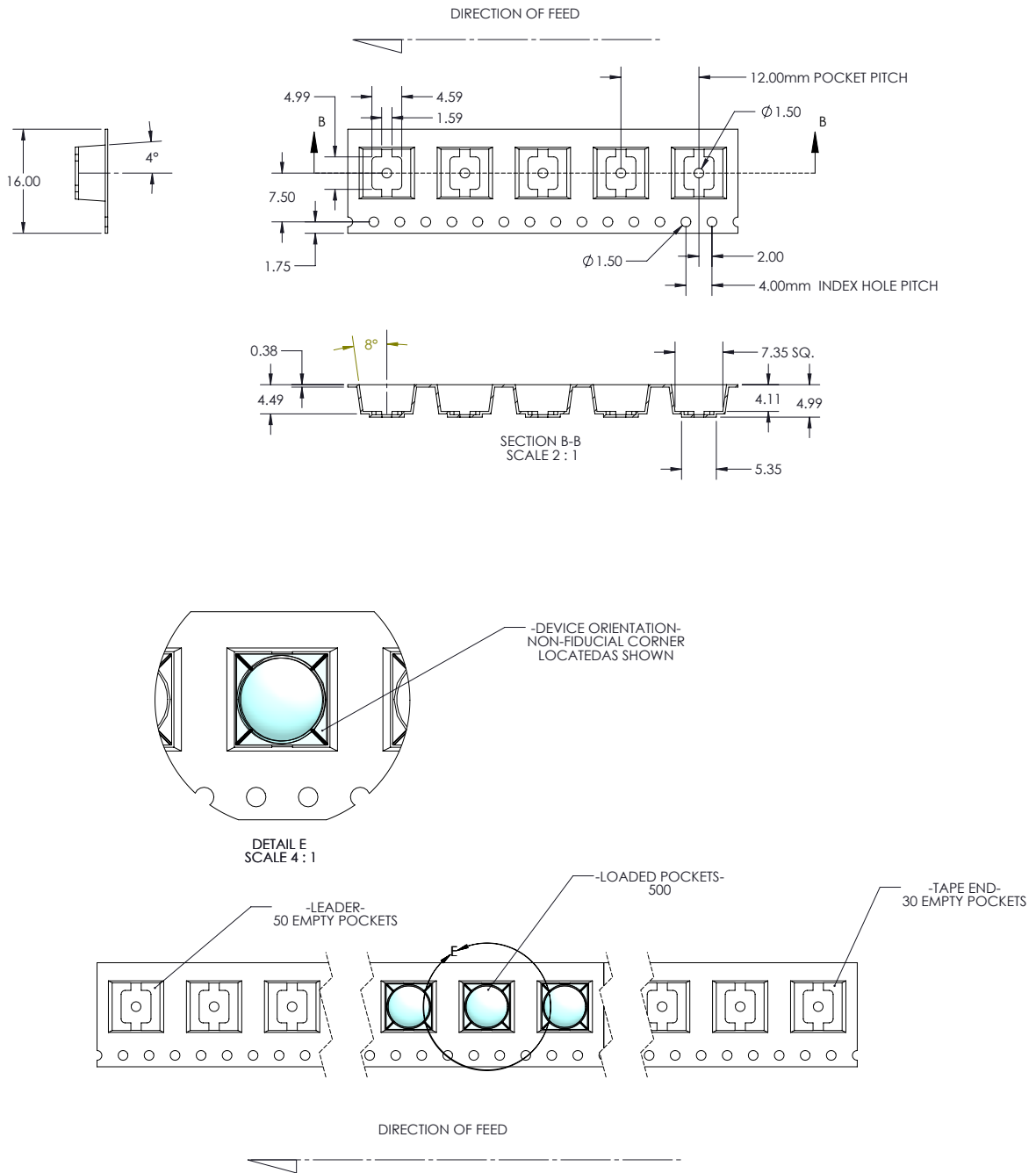

Figure 12: Pocket Tape dimensions for LUXEON M.

Notes for Figure 12:

1. Drawings are not to scale.
2. All dimensions are in millimeters.

Reel Dimensions

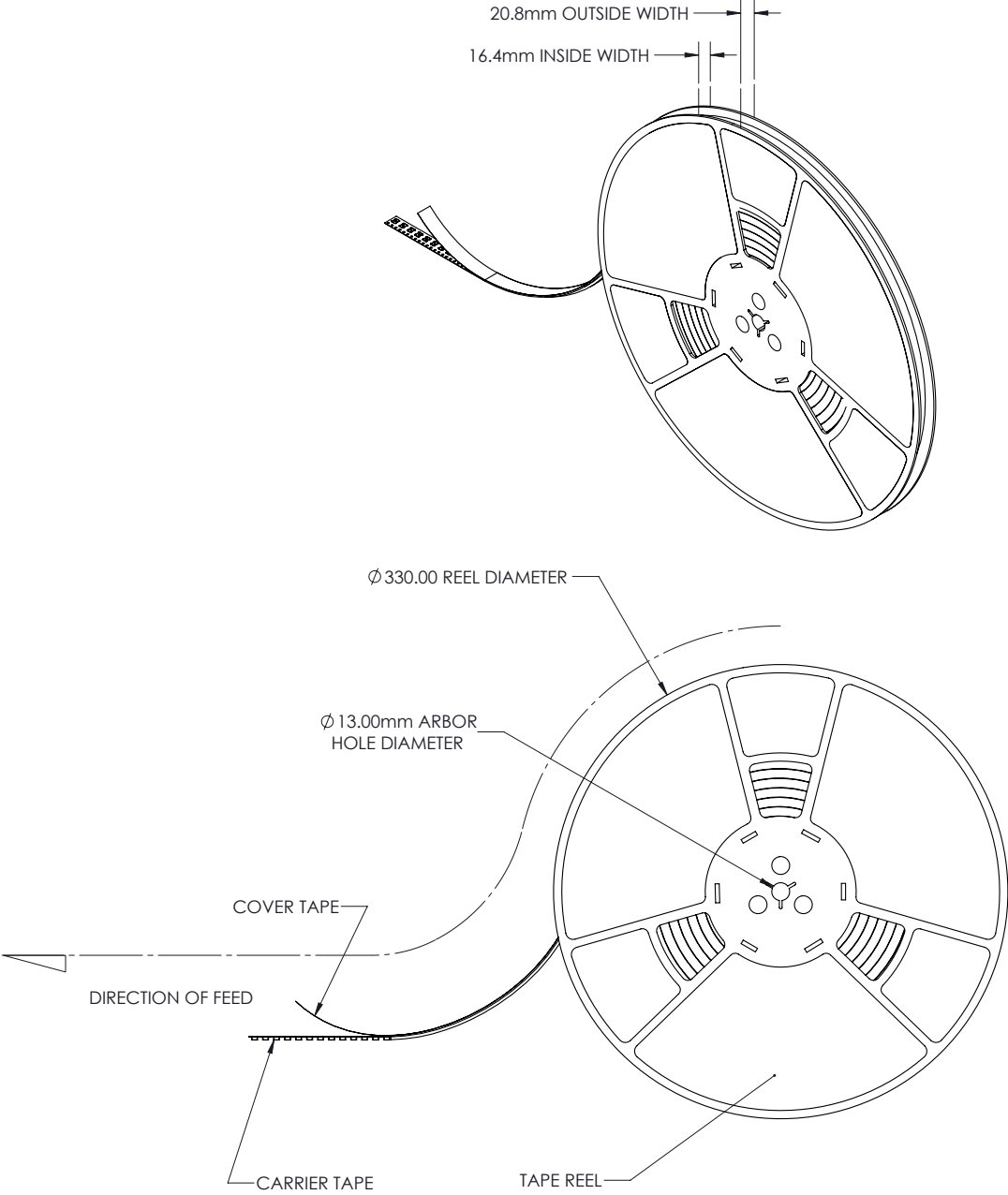

Figure 13: Reel dimensions for LUXEON M.

Notes for Figure 13:
1. Drawings are not to scale.
2. All dimensions are in millimeters.

About Lumileds

Lumileds is the light engine leader, delivering innovation, quality and reliability.

For 100 years, Lumileds commitment to innovation has helped customers pioneer breakthrough products in the automotive, consumer and illumination markets.

Lumileds is shaping the future of light with our LEDs and automotive lamps, and helping our customers illuminate how people see the world around them.

To learn more about our portfolio of light engines, visit lumileds.com.



©2015 Lumileds Holding B.V. All rights reserved.
LUXEON is a registered trademark of the Lumileds Holding B.V.
in the United States and other countries.

lumileds.com

Neither Lumileds Holding B.V. nor its affiliates shall be liable for any kind of loss of data or any other damages, direct, indirect or consequential, resulting from the use of the provided information and data. Although Lumileds Holding B.V. and/or its affiliates have attempted to provide the most accurate information and data, the materials and services information and data are provided "as is," and neither Lumileds Holding B.V. nor its affiliates warrants or guarantees the contents and correctness of the provided information and data. Lumileds Holding B.V. and its affiliates reserve the right to make changes without notice. You as user agree to this disclaimer and user agreement with the download or use of the provided materials, information and data.

DS103 LUXEON M
Product Datasheet 20150820



Компания «ЭлектроПласт» предлагает заключение долгосрочных отношений при поставках импортных электронных компонентов на взаимовыгодных условиях!

Наши преимущества:

- Оперативные поставки широкого спектра электронных компонентов отечественного и импортного производства напрямую от производителей и с крупнейших мировых складов;
- Поставка более 17-ти миллионов наименований электронных компонентов;
- Поставка сложных, дефицитных, либо снятых с производства позиций;
- Оперативные сроки поставки под заказ (от 5 рабочих дней);
- Экспресс доставка в любую точку России;
- Техническая поддержка проекта, помощь в подборе аналогов, поставка прототипов;
- Система менеджмента качества сертифицирована по Международному стандарту ISO 9001;
- Лицензия ФСБ на осуществление работ с использованием сведений, составляющих государственную тайну;
- Поставка специализированных компонентов (Xilinx, Altera, Analog Devices, Intersil, Interpoint, Microsemi, Aeroflex, Peregrine, Syfer, Eurofarad, Texas Instrument, Miteq, Cobham, E2V, MA-COM, Hittite, Mini-Circuits, General Dynamics и др.);

Помимо этого, одним из направлений компании «ЭлектроПласт» является направление «Источники питания». Мы предлагаем Вам помощь Конструкторского отдела:

- Подбор оптимального решения, техническое обоснование при выборе компонента;
- Подбор аналогов;
- Консультации по применению компонента;
- Поставка образцов и прототипов;
- Техническая поддержка проекта;
- Защита от снятия компонента с производства.



Как с нами связаться

Телефон: 8 (812) 309 58 32 (многоканальный)

Факс: 8 (812) 320-02-42

Электронная почта: org@eplast1.ru

Адрес: 198099, г. Санкт-Петербург, ул. Калинина, дом 2, корпус 4, литера А.