

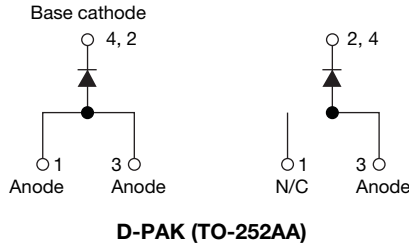

## Ultralow $V_F$ Ultrafast Rectifier, 15 A FRED Pt<sup>®</sup>



VS-15AWL06FN-M3 VS-15EWL06FN-M3



### FEATURES

- Ultrafast recovery time, extremely low  $V_F$  and soft recovery
- 175 °C maximum operating junction temperature
- For PFC DCM operation
- Low leakage current
- Compliant to RoHS Directive 2002/95/EC
- Meets MSL level 1, per J-STD-020, LF maximum peak of 260 °C
- Halogen-free according to IEC 61249-2-21 definition



RoHS COMPLIANT HALOGEN FREE

### DESCRIPTION/APPLICATIONS

State of the art, ultralow  $V_F$ , soft-switching hyperfast rectifiers optimized for Discontinuous (Critical) Mode (DCM) Power Factor Correction (PFC).

The minimized conduction loss, optimized stored charge and low recovery current minimize the switching losses and reduce over dissipation in the switching element and snubbers.

The device is also intended for use as a freewheeling diode in power supplies and other power switching applications.

### PRODUCT SUMMARY

|                 |                  |
|-----------------|------------------|
| Package         | D-PAK (TO-252AA) |
| $I_{F(AV)}$     | 15 A             |
| $V_R$           | 600 V            |
| $V_F$ at $I_F$  | 1.05 V           |
| $t_{rr}$ (typ.) | 60 ns            |
| $T_J$ max.      | 175 °C           |
| Diode variation | Single die       |

### ABSOLUTE MAXIMUM RATINGS

| PARAMETER                                   | SYMBOL         | TEST CONDITIONS                                    | VALUES      | UNITS |
|---------------------------------------------|----------------|----------------------------------------------------|-------------|-------|
| Peak repetitive reverse voltage             | $V_{RRM}$      |                                                    | 600         | V     |
| Average rectified forward current           | $I_{F(AV)}$    | $T_C = 148\text{ °C}$                              | 15          | A     |
| Non-repetitive peak surge current           | $I_{FSM}$      | $T_J = 25\text{ °C}$                               | 180         |       |
| Peak repetitive forward current             | $I_{FM}$       | $T_C = 148\text{ °C}, f = 20\text{ kHz}, d = 50\%$ | 30          |       |
| Operating junction and storage temperatures | $T_J, T_{Stg}$ |                                                    | - 65 to 175 | °C    |

### ELECTRICAL SPECIFICATIONS ( $T_J = 25\text{ °C}$ unless otherwise specified)

| PARAMETER                           | SYMBOL        | TEST CONDITIONS                                                 | MIN. | TYP.         | MAX.         | UNITS         |
|-------------------------------------|---------------|-----------------------------------------------------------------|------|--------------|--------------|---------------|
| Breakdown voltage, blocking voltage | $V_{BR}, V_R$ | $I_R = 100\text{ }\mu\text{A}$                                  | 600  | -            | -            | V             |
| Forward voltage                     | $V_F$         | $I_F = 15\text{ A}$<br>$I_F = 15\text{ A}, T_J = 150\text{ °C}$ | -    | 0.99<br>0.85 | 1.05<br>0.92 |               |
| Reverse leakage current             | $I_R$         | $V_R = V_R$ rated<br>$T_J = 150\text{ °C}, V_R = V_R$ rated     | -    | -            | 10<br>120    | $\mu\text{A}$ |
| Junction capacitance                | $C_T$         | $V_R = 600\text{ V}$                                            | -    | 11           | -            | pF            |
| Series inductance                   | $L_S$         | Measured lead to lead 5 mm from package body                    | -    | 8            | -            | nH            |

## VS-15AWL06FN-M3, VS-15EWL06FN-M3

Vishay Semiconductors Ultralow  $V_F$  Ultrafast Rectifier, 15 A FRED Pt<sup>®</sup>

| DYNAMIC RECOVERY CHARACTERISTICS ( $T_J = 25\text{ }^\circ\text{C}$ unless otherwise specified) |           |                                                                                  |      |      |      |               |
|-------------------------------------------------------------------------------------------------|-----------|----------------------------------------------------------------------------------|------|------|------|---------------|
| PARAMETER                                                                                       | SYMBOL    | TEST CONDITIONS                                                                  | MIN. | TYP. | MAX. | UNITS         |
| Reverse recovery time                                                                           | $t_{rr}$  | $I_F = 1\text{ A}$ , $di_F/dt = 100\text{ A}/\mu\text{s}$ , $V_R = 30\text{ V}$  | -    | 60   | 120  | ns            |
|                                                                                                 |           | $I_F = 15\text{ A}$ , $di_F/dt = 100\text{ A}/\mu\text{s}$ , $V_R = 30\text{ V}$ | -    | 190  | -    |               |
|                                                                                                 |           | $T_J = 25\text{ }^\circ\text{C}$                                                 | -    | 220  | -    |               |
|                                                                                                 |           | $T_J = 125\text{ }^\circ\text{C}$                                                | -    | 290  | -    |               |
| Peak recovery current                                                                           | $I_{RRM}$ | $T_J = 25\text{ }^\circ\text{C}$                                                 | -    | 21   | -    | A             |
|                                                                                                 |           | $T_J = 125\text{ }^\circ\text{C}$                                                | -    | 25   | -    |               |
| Reverse recovery charge                                                                         | $Q_{rr}$  | $T_J = 25\text{ }^\circ\text{C}$                                                 | -    | 2.6  | -    | $\mu\text{C}$ |
|                                                                                                 |           | $T_J = 125\text{ }^\circ\text{C}$                                                | -    | 4    | -    |               |

| THERMAL - MECHANICAL SPECIFICATIONS             |                |                             |           |      |      |                           |
|-------------------------------------------------|----------------|-----------------------------|-----------|------|------|---------------------------|
| PARAMETER                                       | SYMBOL         | TEST CONDITIONS             | MIN.      | TYP. | MAX. | UNITS                     |
| Maximum junction and storage temperature range  | $T_J, T_{Stg}$ |                             | - 65      | -    | 175  | $^\circ\text{C}$          |
| Thermal resistance, junction to case per leg    | $R_{thJC}$     |                             | -         | 1.4  | 1.8  | $^\circ\text{C}/\text{W}$ |
| Thermal resistance, junction to ambient per leg | $R_{thJA}$     |                             | -         | -    | 70   |                           |
| Approximate weight                              |                |                             | 0.3       |      |      | g                         |
|                                                 |                |                             | 0.01      |      |      | oz.                       |
| Marking device                                  |                | Case style D-PAK (TO-252AA) | 15AWL06FN |      |      |                           |
|                                                 |                |                             | 15EWL06FN |      |      |                           |



# VS-15AWL06FN-M3, VS-15EWL06FN-M3

Ultralow  $V_F$  Ultrafast Rectifier, 15 A FRED Pt<sup>®</sup> Vishay Semiconductors

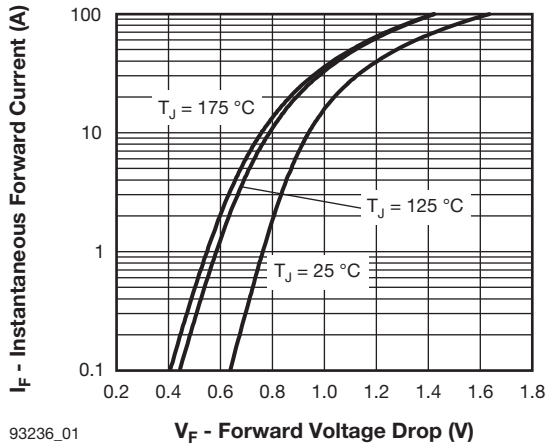

Fig. 1 - Typical Forward Voltage Drop Characteristics

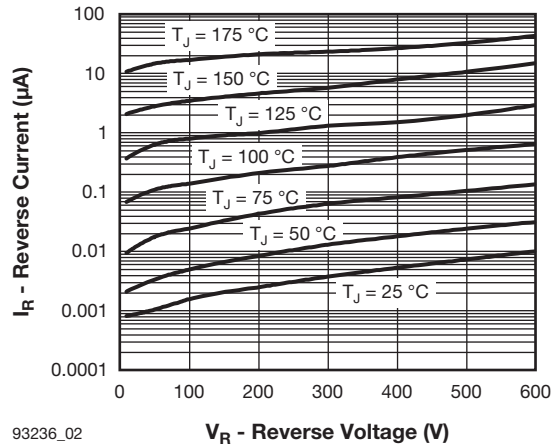

Fig. 2 - Typical Values of Reverse Current vs. Reverse Voltage

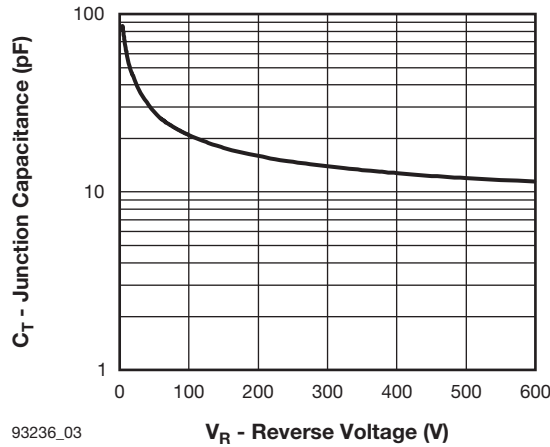

Fig. 3 - Typical Junction Capacitance vs. Reverse Voltage

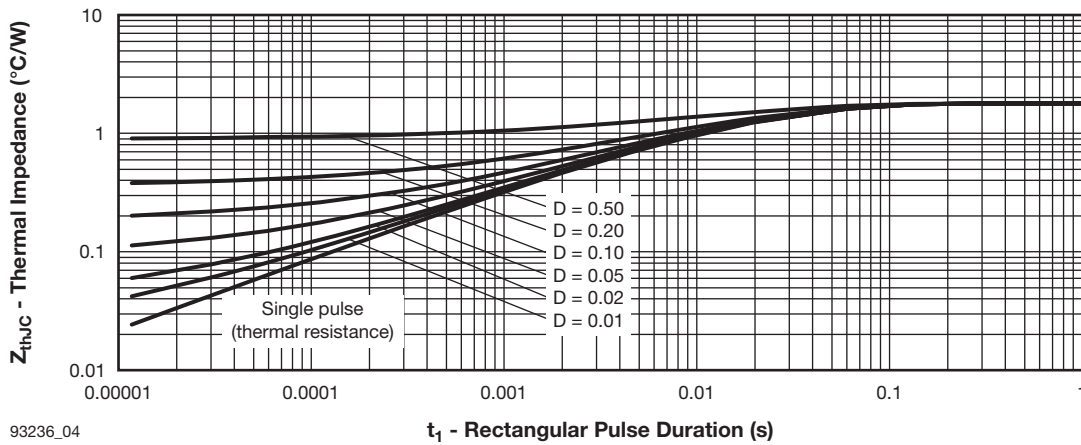
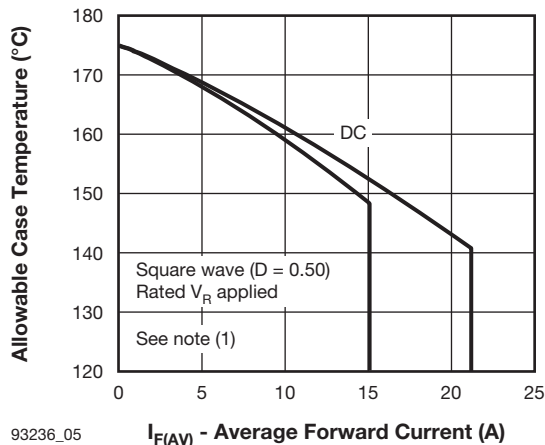

Fig. 4 - Maximum Thermal Impedance  $Z_{thJC}$  Characteristics

# VS-15AWL06FN-M3, VS-15EWL06FN-M3



Vishay Semiconductors Ultralow  $V_F$  Ultrafast Rectifier, 15 A FRED Pt®



93236\_05

**$I_{F(AV)}$  - Average Forward Current (A)**  
 Fig. 5 - Maximum Allowable Case Temperature vs. Average Forward Current

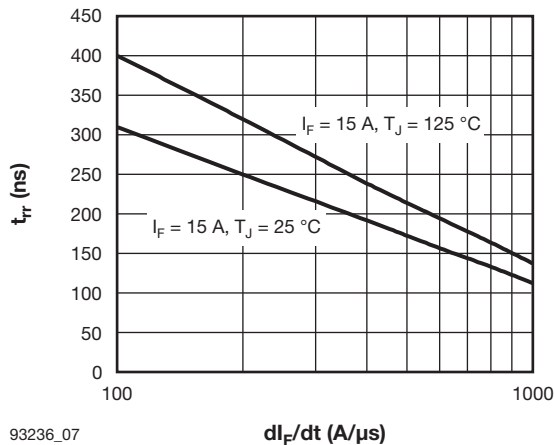

93236\_07

**$di_F/dt$  (A/μs)**  
 Fig. 7 - Typical Reverse Recovery Time vs.  $di_F/dt$

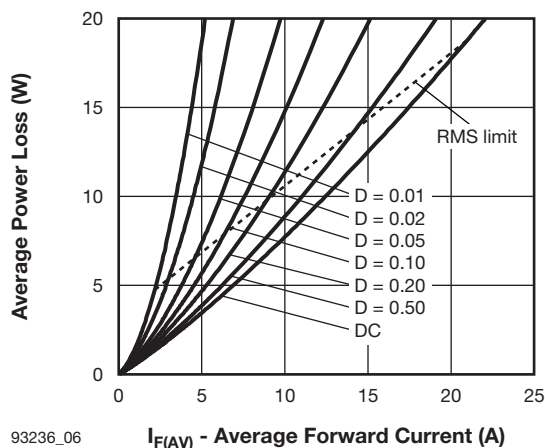

93236\_06

**$I_{F(AV)}$  - Average Forward Current (A)**  
 Fig. 6 - Forward Power Loss Characteristics

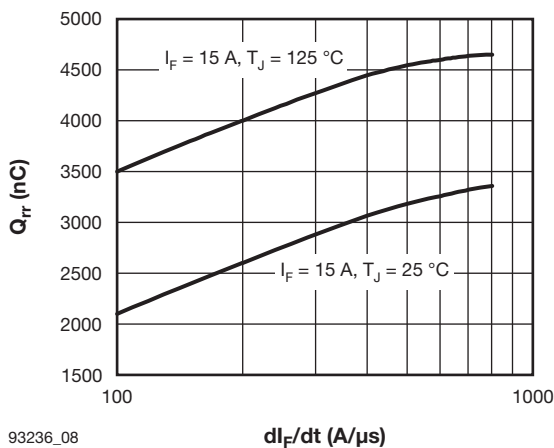

93236\_08

**$di_F/dt$  (A/μs)**  
 Fig. 8 - Typical Stored Charge vs.  $di_F/dt$

**Note**

- (1) Formula used:  $T_C = T_J - (P_d + P_{dREV}) \times R_{thJC}$ ;
- $P_d$  = Forward power loss =  $I_{F(AV)} \times V_{FM}$  at  $(I_{F(AV)}/D)$  (see fig. 6);
- $P_{dREV}$  = Inverse power loss =  $V_{R1} \times I_R (1 - D)$ ;  $I_R$  at  $V_{R1}$  = Rated  $V_R$



# VS-15AWL06FN-M3, VS-15EWL06FN-M3

Ultralow  $V_F$  Ultrafast Rectifier, 15 A FRED Pt<sup>®</sup> Vishay Semiconductors

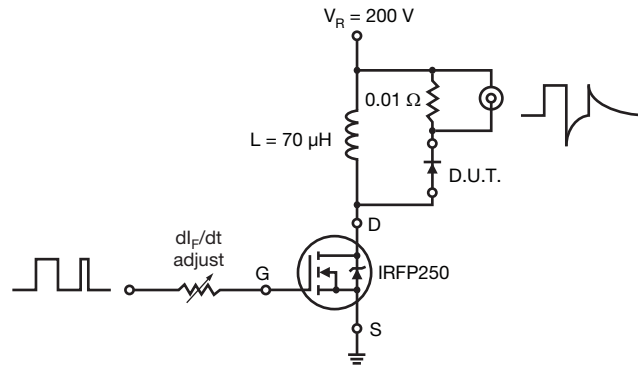
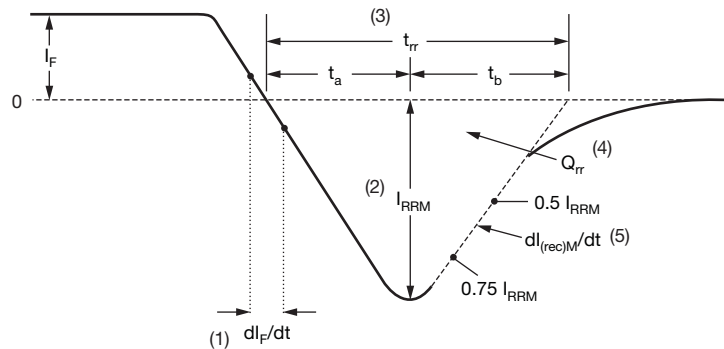

Fig. 9 - Reverse Recovery Parameter Test Circuit



- (1)  $dI_F/dt$  - rate of change of current through zero crossing
- (2)  $I_{RRM}$  - peak reverse recovery current
- (3)  $t_{rr}$  - reverse recovery time measured from zero crossing point of negative going  $I_F$  to point where a line passing through  $0.75 I_{RRM}$  and  $0.50 I_{RRM}$  extrapolated to zero current.
- (4)  $Q_{rr}$  - area under curve defined by  $t_{rr}$  and  $I_{RRM}$
- (5)  $dI_{(rec)M}/dt$  - peak rate of change of current during  $t_b$  portion of  $t_{rr}$

$$Q_{rr} = \frac{t_{rr} \times I_{RRM}}{2}$$

Fig. 10 - Reverse Recovery Waveform and Definitions

# VS-15AWL06FN-M3, VS-15EWL06FN-M3



Vishay Semiconductors Ultralow  $V_F$  Ultrafast Rectifier, 15 A FRED Pt<sup>®</sup>

## ORDERING INFORMATION TABLE

|             |     |    |   |   |   |    |    |     |     |
|-------------|-----|----|---|---|---|----|----|-----|-----|
| Device code | VS- | 15 | A | W | L | 06 | FN | TRL | -M3 |
|             | ①   | ②  | ③ | ④ | ⑤ | ⑥  | ⑦  | ⑧   | ⑨   |

- 1** - Vishay Semiconductors product
- 2** - Current rating (15 = 15 A)
- 3** - Circuit configuration:
  - A = Single diode (2 anodes)
  - E = Single diode
- 4** - Package identifier:
  - W = D-PAK
- 5** - L = Hyperfast rectifier
- 6** - Voltage rating (06 = 600 V)
- 7** - FN = TO-252AA
- 8** -
  - None = Tube
  - TR = Tape and reel
  - TRL = Tape and reel (left oriented)
  - TRR = Tape and reel (right oriented)
- 9** - Environmental digit:
  - M3 = Halogen-free, RoHS compliant and terminations lead (Pb)-free

| ORDERING INFORMATION (Example) |                  |                        |                         |
|--------------------------------|------------------|------------------------|-------------------------|
| PREFERRED P/N                  | QUANTITY PER T/R | MINIMUM ORDER QUANTITY | PACKAGING DESCRIPTION   |
| VS-15AWL06FN-M3                | 75               | 3000                   | Antistatic plastic tube |
| VS-15EWL06FN-M3                |                  |                        |                         |
| VS-15AWL06FNTR-M3              | 2000             | 2000                   | 13" diameter reel       |
| VS-15EWL06FNTR-M3              |                  |                        |                         |
| VS-15AWL06FNTRL-M3             | 3000             | 3000                   | 13" diameter reel       |
| VS-15EWL06FNTRL-M3             |                  |                        |                         |
| VS-15AWL06FNTRR-M3             | 3000             | 3000                   | 13" diameter reel       |
| VS-15EWL06FNTRR-M3             |                  |                        |                         |

| LINKS TO RELATED DOCUMENTS |                                                                        |
|----------------------------|------------------------------------------------------------------------|
| Dimensions                 | <a href="http://www.vishay.com/doc?95016">www.vishay.com/doc?95016</a> |
| Part marking information   | <a href="http://www.vishay.com/doc?95176">www.vishay.com/doc?95176</a> |
| Packaging information      | <a href="http://www.vishay.com/doc?95033">www.vishay.com/doc?95033</a> |
| SPIICE model               | <a href="http://www.vishay.com/doc?95372">www.vishay.com/doc?95372</a> |

## D-PAK (TO-252AA)

### DIMENSIONS in millimeters and inches



| SYMBOL | MILLIMETERS |      | INCHES |       | NOTES | SYMBOL | MILLIMETERS |       | INCHES     |       | NOTES |
|--------|-------------|------|--------|-------|-------|--------|-------------|-------|------------|-------|-------|
|        | MIN.        | MAX. | MIN.   | MAX.  |       |        | MIN.        | MAX.  | MIN.       | MAX.  |       |
| A      | 2.18        | 2.39 | 0.086  | 0.094 |       | e      | 2.29 BSC    |       | 0.090 BSC  |       |       |
| A1     | -           | 0.13 | -      | 0.005 |       | H      | 9.40        | 10.41 | 0.370      | 0.410 |       |
| b      | 0.64        | 0.89 | 0.025  | 0.035 |       | L      | 1.40        | 1.78  | 0.055      | 0.070 |       |
| b2     | 0.76        | 1.14 | 0.030  | 0.045 |       | L1     | 2.74 BSC    |       | 0.108 REF. |       |       |
| b3     | 4.95        | 5.46 | 0.195  | 0.215 | 3     | L2     | 0.51 BSC    |       | 0.020 BSC  |       |       |
| c      | 0.46        | 0.61 | 0.018  | 0.024 |       | L3     | 0.89        | 1.27  | 0.035      | 0.050 | 3     |
| c2     | 0.46        | 0.89 | 0.018  | 0.035 |       | L4     | -           | 1.02  | -          | 0.040 |       |
| D      | 5.97        | 6.22 | 0.235  | 0.245 | 5     | L5     | 1.14        | 1.52  | 0.045      | 0.060 | 2     |
| D1     | 5.21        | -    | 0.205  | -     | 3     | Ø      | 0°          | 10°   | 0°         | 10°   |       |
| E      | 6.35        | 6.73 | 0.250  | 0.265 | 5     | Ø1     | 0°          | 15°   | 0°         | 15°   |       |
| E1     | 4.32        | -    | 0.170  | -     | 3     | Ø2     | 25°         | 35°   | 25°        | 35°   |       |

### Notes

- (1) Dimensioning and tolerancing as per ASME Y14.5M-1994
- (2) Lead dimension uncontrolled in L5
- (3) Dimension D1, E1, L3 and b3 establish a minimum mounting surface for thermal pad
- (4) Section C - C dimension apply to the flat section of the lead between 0.13 and 0.25 mm (0.005 and 0.10") from the lead tip
- (5) Dimension D, and E do not include mold flash. Mold flash shall not exceed 0.127 mm (0.005") per side. These dimensions are measured at the outermost extremes of the plastic body
- (6) Dimension b1 and c1 applied to base metal only
- (7) Datum A and B to be determined at datum plane H
- (8) Outline conforms to JEDEC outline TO-252AA



## Disclaimer

ALL PRODUCT, PRODUCT SPECIFICATIONS AND DATA ARE SUBJECT TO CHANGE WITHOUT NOTICE TO IMPROVE RELIABILITY, FUNCTION OR DESIGN OR OTHERWISE.

Vishay Intertechnology, Inc., its affiliates, agents, and employees, and all persons acting on its or their behalf (collectively, "Vishay"), disclaim any and all liability for any errors, inaccuracies or incompleteness contained in any datasheet or in any other disclosure relating to any product.

Vishay makes no warranty, representation or guarantee regarding the suitability of the products for any particular purpose or the continuing production of any product. To the maximum extent permitted by applicable law, Vishay disclaims (i) any and all liability arising out of the application or use of any product, (ii) any and all liability, including without limitation special, consequential or incidental damages, and (iii) any and all implied warranties, including warranties of fitness for particular purpose, non-infringement and merchantability.

Statements regarding the suitability of products for certain types of applications are based on Vishay's knowledge of typical requirements that are often placed on Vishay products in generic applications. Such statements are not binding statements about the suitability of products for a particular application. It is the customer's responsibility to validate that a particular product with the properties described in the product specification is suitable for use in a particular application. Parameters provided in datasheets and/or specifications may vary in different applications and performance may vary over time. All operating parameters, including typical parameters, must be validated for each customer application by the customer's technical experts. Product specifications do not expand or otherwise modify Vishay's terms and conditions of purchase, including but not limited to the warranty expressed therein.

Except as expressly indicated in writing, Vishay products are not designed for use in medical, life-saving, or life-sustaining applications or for any other application in which the failure of the Vishay product could result in personal injury or death. Customers using or selling Vishay products not expressly indicated for use in such applications do so at their own risk. Please contact authorized Vishay personnel to obtain written terms and conditions regarding products designed for such applications.

No license, express or implied, by estoppel or otherwise, to any intellectual property rights is granted by this document or by any conduct of Vishay. Product names and markings noted herein may be trademarks of their respective owners.

## Material Category Policy

**Vishay Intertechnology, Inc. hereby certifies that all its products that are identified as RoHS-Compliant fulfill the definitions and restrictions defined under Directive 2011/65/EU of The European Parliament and of the Council of June 8, 2011 on the restriction of the use of certain hazardous substances in electrical and electronic equipment (EEE) - recast, unless otherwise specified as non-compliant.**

**Please note that some Vishay documentation may still make reference to RoHS Directive 2002/95/EC. We confirm that all the products identified as being compliant to Directive 2002/95/EC conform to Directive 2011/65/EU.**

**Vishay Intertechnology, Inc. hereby certifies that all its products that are identified as Halogen-Free follow Halogen-Free requirements as per JEDEC JS709A standards. Please note that some Vishay documentation may still make reference to the IEC 61249-2-21 definition. We confirm that all the products identified as being compliant to IEC 61249-2-21 conform to JEDEC JS709A standards.**





Компания «ЭлектроПласт» предлагает заключение долгосрочных отношений при поставках импортных электронных компонентов на взаимовыгодных условиях!

Наши преимущества:

- Оперативные поставки широкого спектра электронных компонентов отечественного и импортного производства напрямую от производителей и с крупнейших мировых складов;
- Поставка более 17-ти миллионов наименований электронных компонентов;
- Поставка сложных, дефицитных, либо снятых с производства позиций;
- Оперативные сроки поставки под заказ (от 5 рабочих дней);
- Экспресс доставка в любую точку России;
- Техническая поддержка проекта, помощь в подборе аналогов, поставка прототипов;
- Система менеджмента качества сертифицирована по Международному стандарту ISO 9001;
- Лицензия ФСБ на осуществление работ с использованием сведений, составляющих государственную тайну;
- Поставка специализированных компонентов (Xilinx, Altera, Analog Devices, Intersil, Interpoint, Microsemi, Aeroflex, Peregrine, Syfer, Eurofarad, Texas Instrument, Miteq, Cobham, E2V, MA-COM, Hittite, Mini-Circuits, General Dynamics и др.);

Помимо этого, одним из направлений компании «ЭлектроПласт» является направление «Источники питания». Мы предлагаем Вам помощь Конструкторского отдела:

- Подбор оптимального решения, техническое обоснование при выборе компонента;
- Подбор аналогов;
- Консультации по применению компонента;
- Поставка образцов и прототипов;
- Техническая поддержка проекта;
- Защита от снятия компонента с производства.



#### Как с нами связаться

**Телефон:** 8 (812) 309 58 32 (многоканальный)

**Факс:** 8 (812) 320-02-42

**Электронная почта:** [org@eplast1.ru](mailto:org@eplast1.ru)

**Адрес:** 198099, г. Санкт-Петербург, ул. Калинина, дом 2, корпус 4, литера А.