



## Features:

- One thru four poles
- Two thru four positions for switching up to 13.0 @ 125 Vac
- Detent or spring return
- Panel or P.C. Mount
- Top or side actuation
- UL/CSA listed
- Solder, solderless receptacle or wire wrap termination

ISO 9001 REGISTERED

Catalog S2120-II/03

## About CW Slide Switches

Slide switches became popular in America with industrial expansion after World War I . . . at the same time radios, autos, appliances and countless other consumer products were being developed. CW responded with its line of switches planned to meet the needs of the day. Considered "standard" was its two-position switch intended for chassis mount on two 1.125"-centered mounting holes. Terminals were designed for convenience in hand soldering. Actuation was with a trigger extending out the switch top, and switches were generally constructed for switching up to 1.0 amps at 125 volts ac.

Industry needs changed after World War II. Mass-produced radios, TVs, electrical and electronic instruments, appliances, telephones, automobiles, aircraft and marine equipment, and more recently

calculators and computers, have proved to be ideal applications for our very simple and yet very reliable slide switch.

Modern switching requirements have broadened the scope of what is now required . . . higher current ratings . . . more positions . . . more poles . . . varying actuation means . . . many mounting options . . . variety of contact surfaces . . . and the solutions to varying terminating problems.

Since first introducing its slide switches, to satisfy these modern switching requirements, CW has constantly expanded and added options to its original "standard" line . . . all of which will be described on these pages. Other types . . . miniature, micro-miniature, and power . . . are described in supplemental literature referenced on page 35.

## CW Switch Construction



## Materials

Materials . . . like CW switches . . . have changed over the years. Improvements in available materials are constantly sought out by CW engineers and adapted for use in CW switches if found to be suitable. Considered standard are those materials listed. Adjustments or changes will be made if other materials are found more suitable for your application.

**Buttons** — Type 6/6 Nylon. Black is standard. Colors are available if your quantity is sufficient.

**Housings** — Cold rolled steel

**Housing Plating** — Zinc followed by clear chromate.

**Moving Contact** — Copper, copper alloy or brass.

**Moving Contact Plating** — Silver is standard. Gold (30 microinches of gold over 50 microinches of nickel) is available. Other gold thicknesses are available if your quantities are sufficient.

**Moving Contact Spring** — Phosphor bronze or beryllium copper.

**Terminals** — Copper

**Terminal Plating** — Silver is standard. Gold (30 microinches over 50 microinches of nickel) on many popular types is available. Other gold thicknesses are available if your quantities are sufficient.

**Terminal Board** — N.E.M.A. Grade XP Phenolic Laminate

## Performance Standards and Operating Limitations

When operated within ambient conditions detailed below, CW switches are designed to perform to the standards also listed below:

**Operating Temperature** — 104°C Max  
- 10°C Min

**Relative Humidity** — Switches will be operable and insulation resistance shall be greater than 100 megohms if allowed to dry for 100 hours at room temperature of 25°C and after exposure for one hour in an atmosphere having 95% relative humidity and a temperature of 50°C.

**High Voltage Breakdown** — Minimum of 1000 volts RMS, 60 Hz for one minute between parts of opposite polarity.

**Contact Resistance** — Less than 0.01 ohm at 20 milliamperes dc.

**LIFE CYCLING (no load):** Switches will be operative after 10,000 (minimum) cycles at the rate of 10 cycles per minute.

**LIFE CYCLING (load):** Switches will be operative after 6000 (minimum) cycles at the rate of 10 cycles per minute at rated load.

### U.L. and C.S.A.

CW Test Laboratories are fully equipped to monitor and test CW switches to U.L. and C.S.A. published standards. Most CW switches are listed by these agencies as having conformed to those standards in tests applied to those switches on a continuing basis. A record of types of CW switches listed by U.L. is retained in U.L. File Number E9556 and in C.S.A. File Number LR20985.

### CW Patents

CW Engineers are constantly trying to upgrade the quality and cost-effectiveness of our switches. Often this results in new inventions. Switch products shown in this catalog may be covered by one or more of the following U.S. patents:

|           |           |
|-----------|-----------|
| 3,270,149 | 3,993,881 |
| 3,271,535 | 4,404,437 |
| 3,311,719 | 4,128,745 |
| 3,461,252 | 4,410,232 |

Other patent applications are pending.

## STANDARD SIZED SWITCHES — TO 13.0A AC @ 125V (Highest Current Rating - Lowest Price)

| Model No. | Circuitry            | Electrical Rating<br>@ 125V unless<br>otherwise noted | Page No. | Special Features         |              |
|-----------|----------------------|---|----------|--------------------------|--------------|
| GF-323    | SPST (with detent)   | 3.0A AC, 0.5A DC                                      | 6        | Top Actuated             |              |
| GF-623    | SPST (with detent)   | 6.0A AC, 0.5A DC                                      | 6        |                          |              |
| GF-823    | SPST (with detent)   | 8.0A DC @ 12V   | 6        |                          |              |
| GF-1123   | SPST (with detent)   | 11.0A AC, 0.5A DC                                     | 6        |                          |              |
| GF-1323   | SPST (with detent)   | 13.0A AC, 0.5A DC                                     | 6        |                          |              |
| GF-1623   | SPST (with detent)   | 3.0A AC "L Rated"                                     | 6        |                          |              |
| GF-324    | SPDT (with detent)   | 3.0A AC, 0.5A DC                                      | 6        |                          |              |
| GF-624    | SPDT (with detent)   | 6.0A AC, 0.5A DC                                      | 6        |                          |              |
| GF-824    | SPDT (with detent)   | 8.0A DC @ 12V   | 6        |                          |              |
| GF-1124   | SPDT (with detent)   | 11.0A AC, 0.5A DC                                     | 6        |                          |              |
| GF-1324   | SPDT (with detent)   | 13.0A AC, 0.5A DC                                     | 6        |                          |              |
| GF-1624   | SPDT (with detent)   | 3.0A AC "L Rated"                                     | 6        |                          |              |
| GDD-323   | SPST (with detent)   | 3.0A AC, 0.5 DC                                       | 8        | Top Actuated<br>Patented |              |
| GDD-623   | SPST (with detent)   | 6.0A AC, 0.5A DC                                      | 8        |                          |              |
| GDD-1123  | SPST (with detent)   | 11.0A AC, 0.5 DC                                      | 8        |                          |              |
| GDD-324   | SPDT (with detent)   | 3.0A AC, 0.5 DC                                       | 8        |                          |              |
| GDD-624   | SPDT (with detent)   | 6.0A AC, 0.5 DC                                       | 8        |                          |              |
| GDD-1124  | SPDT (with detent)   | 11.0A AC, 0.5 DC                                      | 8        |                          |              |
| GDD-326   | DPDT (with detent)   | 3.0A AC, 0.5 DC                                       | 8        |                          |              |
| GM-311    | SPST (spring return) | 3.0A AC, 0.5 DC                                       | 9        | Push Down (Momentary)    |              |
| G-331     | SPST (spring return) | 3.0A AC, 0.5A DC                                      | 10       | Top Actuated (Momentary) |              |
| G-631     | SPST (spring return) | 6.0A AC, 0.5A DC                                      | 10       |                          |              |
| G-831     | SPST (spring return) | 8.0A DC @ 12V   | 10       |                          |              |
| G-1131    | SPST (spring return) | 11.0A AC, 0.5A DC                                     | 10       |                          |              |
| G-1331    | SPST (spring return) | 13.0A AC, 0.5A DC                                     | 10       |                          |              |
| G-332     | SPDT (spring return) | 3.0A AC, 0.5A DC                                      | 10       |                          |              |
| G-632     | SPDT (spring return) | 6.0A AC, 0.5A DC                                      | 10       |                          |              |
| G-832     | SPDT (spring return) | 8.0A DC @ 12V   | 10       |                          |              |
| G-1132    | SPDT (spring return) | 11.0A AC, 0.5A DC                                     | 10       |                          |              |
| G-1332    | SPDT (spring return) | 13.0A AC, 0.5A DC                                     | 10       |                          |              |
| GF-325    | DPST (with detent)   | 3.0A AC, 0.5A DC                                      | 12       |                          | Top Actuated |
| GF-625    | DPST (with detent)   | 6.0A AC, 0.5A DC                                      | 12       |                          |              |
| GF-825    | DPST (with detent)   | 8A DC @ 12V   | 12       |                          |              |
| GF-1125   | DPST (with detent)   | 11.0A AC, 0.5A DC                                     | 12       |                          |              |
| GF-1325   | DPST (with detent)   | 13.0A AC, 0.5A DC                                     | 12       |                          |              |
| GF-1625   | DPST (with detent)   | 3.0A AC "L Rated"                                     | 12       |                          |              |
| GF-326    | DPDT (with detent)   | 3.0A AC, 0.5A DC                                      | 12       |                          |              |
| GF-626    | DPDT (with detent)   | 6.0A AC, 0.5A DC                                      | 12       |                          |              |
| GF-826    | DPDT (with detent)   | 8.0 A DC @ 12V  | 12       |                          |              |
| GF-1126   | DPDT (with detent)   | 11.0A AC, 0.5A DC                                     | 12       |                          |              |
| GF-1326   | DPDT (with detent)   | 13.0A AC, 0.5A DC                                     | 12       |                          |              |
| GF-1626   | DPDT (with detent)   | 3.0A AC "L Rated"                                     | 12       |                          |              |



# Selection Guide

## STANDARD SIZED SWITCHES - TO 13.0A AC @ 125V (Highest Current Rating - Lowest Price)

| Model No. | Circuitry                 | Electrical Rating<br>@ 125V unless<br>otherwise noted | Page No. | Special Features   |
|-----------|---------------------------|---|----------|--|
| G-375A    | DPDT (spring return)      | 3.0A AC, 0.5A DC                                      | 14       | Top Actuated (Momentary)                                       |
| GF-361    | 3PDT (with detent)        | 3.0A AC, 0.5A DC                                      | 15       | Top Actuated   |
| GF-661    | 3PDT (with detent)        | 6.0A AC, 0.5A DC                                      | 15       |  |
| GF-861    | 3PDT (with detent)        | 8.0A DC @ 12V   | 15       |  |
| GF-1161   | 3PDT (with detent)        | 11.0A AC (22A Total)                                  | 15       |  |
| GF-1361   | 3PDT (with detent)        | 13.0A AC (26A Total)                                  | 15       |  |
| GF-342    | 4PDT (with detent)        | 3.0A AC, 0.5A DC                                      | 16       |  |
| GF-642    | 4PDT (with detent)        | 6.0A AC, 0.5A DC                                      | 16       |  |
| GF-842    | 4PDT (with detent)        | 8.0A DC @ 12V   | 16       |  |
| GF-1142   | 4PDT (with detent)        | 11.0A AC (22A Total)                                  | 16       |  |
| GF-1342   | 4PDT (with detent)        | 13.0A AC (26A Total)                                  | 16       |  |
| G-329-L   | SP 3 Pos. (with detent)   | 3.0A AC, 0.5A DC                                      | 17       | Top Actuated   |
| G-329-S   | SP 3 Pos. (with detent)   | 3.0A AC, 0.5A DC                                      | 17       |  |
| G-629-L   | SP 3 Pos. (with detent)   | 6.0A AC, 0.5A DC                                      | 17       |  |
| G-629-S   | SP 3 Pos. (with detent)   | 6.0A AC, 0.5A DC                                      | 17       |  |
| G-829-L   | SP 3 Pos. (with detent)   | 8.0A DC @ 12V   | 17       |  |
| G-829-S   | SP 3 Pos. (with detent)   | 8.0A DC @ 12V   | 17       |  |
| G-1129-L  | SP 3 Pos. (with detent)   | 11.0A AC, 0.5A DC                                     | 17       |  |
| G-1129-S  | SP 3 Pos. (with detent)   | 11.0A AC, 0.5A DC                                     | 17       |  |
| G-1329-L  | SP 3 Pos. (with detent)   | 13.0A AC, 0.5A DC                                     | 17       |  |
| G-1329-S  | SP 3 Pos. (with detent)   | 13.0A AC, 0.5A DC                                     | 17       |  |
| G-490     | SP 3 Pos. (with detent)   | 4.0A AC, 0.5A DC<br>1.0A AC @ 250V                    | 19       | Top Actuated   |
| G-690     | SP 3 Pos. (with detent)   | 6.0A AC, 0.5A DC<br>1.0A AC @ 250V                    | 19       |  |
| G-333-S   | SP 3 Pos. (spring return) | 3.0A AC, 0.5A DC                                      | 20       | Spring Return One End to Center,<br>Detent Other End to Center |
| G-633-S   | SP 3 Pos. (spring return) | 6.0A AC, 0.5A DC                                      | 20       |  |
| G-328-L   | DP 3 Pos. (with detent)   | 3.0A AC, 0.5A DC                                      | 21       | Top Actuated   |
| G-328-S   | DP 3 Pos. (with detent)   | 3.0A AC, 0.5A DC                                      | 21       |  |
| G-628-L   | DP 3 Pos. (with detent)   | 6.0A AC, 0.5A DC                                      | 21       |  |
| G-628-S   | DP 3 Pos. (with detent)   | 6.0A AC, 0.5A DC                                      | 21       |  |
| G-828-L   | DP 3 Pos. (with detent)   | 8.0A DC @ 12V   | 21       |  |
| G-828-S   | DP 3 Pos. (with detent)   | 8.0A DC @ 12V   | 21       |  |
| G-1128-L  | DP 3 Pos. (with detent)   | 11.0A AC, 0.5A DC                                     | 21       |  |
| G-1128-S  | DP 3 Pos. (with detent)   | 11.0A AC, 0.5A DC                                     | 21       |  |
| G-1328-L  | DP 3 Pos. (with detent)   | 13.0A AC, 0.5A DC                                     | 21       |  |
| G-1328-S  | DP 3 Pos. (with detent)   | 13.0A AC, 0.5A DC                                     | 21       |  |

## STANDARD SIZED SWITCHES - TO 13.0A AC @ 125V (Highest Current Rating - Lowest Price)

| Model No.          | Circuitry                 | Electrical Rating @ 125V unless otherwise noted | Page No. | Special Features  |
|--------------------|---------------------------|---|----------|---|
| G-335-S            | DP 3 Pos. (spring return) | 3.0A AC, 0.5A DC                                | 22       | Spring Return One End to Center, Detent Other End to Center               |
| G-635-S            | DP 3 Pos. (spring return) | 6.0A AC, 0.5A DC                                | 22       |   |
| G-378-A            | 3PDT (spring return)      | 3.0A AC, 0.5A DC                                | 23       | Top Actuated (Momentary)  |
| G-368-L            | 3P 3 Pos. (with detent)   | 3.0A AC, 0.5A DC                                | 24       | Top Actuated  |
| G-368-S            | 3P 3 Pos. (with detent)   | 3.0A AC, 0.5A DC                                | 24       |   |
| G-668-L            | 3P 3 Pos. (with detent)   | 6.0A AC (12A Total)                             | 24       |   |
| G-668-S            | 3P 3 Pos. (with detent)   | 6.0A AC (12A Total)                             | 24       |   |
| G-337-S            | 3P 3 Pos. (spring return) | 3.0A AC, 0.5A DC                                | 25       | Spring Return One End to Center, Detent Other End to Center               |
| G-637-S            | 3P 3 Pos. (spring return) | 6.0A AC, 0.5A DC                                | 25       |   |
| G-360-L            | 4P 3 Pos. (with detent)   | 3.0A AC, 0.5A DC                                | 26       |   |
| G-360-S            | 4P 3 Pos. (with detent)   | 3.0A AC, 0.5A DC                                | 26       |   |
| G-660-L            | 4P 3 Pos. (with detent)   | 6.0A AC (12A Total)                             | 26       |   |
| G-660-S            | 4P 3 Pos. (with detent)   | 6.0A AC (12A Total)                             | 26       |   |
| G-338-L            | DP 4 Pos. (with detent)   | 3.0A AC 0.5A DC                                 | 27       | Top Actuated  |
| G-338-S            | DP 4 Pos. (with detent)   | 3.0A AC 0.5A DC                                 | 27       |   |
| G-638-L            | DP 4 Pos. (with detent)   | 6.0A AC 0.5A DC                                 | 27       |   |
| G-638-S            | DP 4 Pos. (with detent)   | 6.0A AC 0.5A DC                                 | 27       |   |
| G-838-L            | DP 4 Pos. (with detent)   | 8.0A DC @ 12V                                   | 27       |   |
| G-838-S            | DP 4 Pos. (with detent)   | 8.0A DC @ 12V                                   | 27       |   |
| G-1138-L           | DP 4 Pos. (with detent)   | 11.0A AC, 0.5A DC                               | 27       |   |
| G-1138-S           | DP 4 Pos. (with detent)   | 11.0A AC, 0.5A DC                               | 27       |   |
| G-1338-L           | DP 4 Pos. (with detent)   | 13.0A AC, 0.5A DC                               | 27       |   |
| G-1338-S           | DP 4 Pos. (with detent)   | 13.0A AC, 0.5A DC                               | 27       |   |
| GG-351             | SPDT (with detent)        | 3.0A AC, 0.5A DC                                | 28       | Side Actuated   |
| GG-355             | SPDT (spring return)      | 3.0A AC, 0.5 DC                                 | 29       |   |
| GG-350             | DPDT (with detent)        | 3.0A AC, 0.5A DC                                | 30       |   |
| GG-372             | SPDT (with detent)        | 3.0A AC, 0.5A DC                                | 31       | Self Supporting on PC Board Side Actuated                                 |
| GG-387             | DPDT (with detent)        | 3.0A AC, 0.5A DC                                | 31       |   |
| G-386              | DP 3 Pos. (with detent)   | 3.0A AC, 0.5A DC                                | 32       |   |
| GR-Rocker Actuated |                           |   | 33-34    | For Adapting Standard Slide Switches To Meet Other Actuation Requirements |



# Slide Switch-Standard

**GF-323 SINGLE POLE/SINGLE THROW (with detent)**  
**GF-324 SINGLE POLE/DOUBLE THROW (with detent)**



| TYPE    | ELECTRICAL RATING            | LISTING       |
|---------|------------------------------|---------------|
| GF-323  | 3.0 A AC, 0.5 A DC at 125 V  | U.L. & C.S.A. |
| GF-623  | 6.0 A AC, 0.5 A DC at 125 V  | U.L. & C.S.A. |
| GF-823  | 8.0 A DC at 12 V             |               |
| GF-1123 | 11.0 A AC, 0.5 A DC at 125 V | U.L. & C.S.A. |
| GF-1323 | 13.0 A AC, 0.5 A DC at 125 V | U.L. & C.S.A. |
| GF-1623 | 3.0 A AC at 125 V "L" rated  | U.L.          |
| GF-324  | 3.0 A AC, 0.5 A DC at 125 V  | U.L. & C.S.A. |
| GF-624  | 6.0 A AC, 0.5 A DC at 125 V  | U.L. & C.S.A. |
| GF-824  | 8.0 A DC at 12 V             |               |
| GF-1124 | 11.0 A AC, 0.5 A DC at 125 V | U.L. & C.S.A. |
| GF-1324 | 13.0 A AC, 0.5 A DC at 125 V | U.L. & C.S.A. |
| GF-1624 | 3.0 A AC at 125 V "L" rated  | U.L.          |



**GF-324**  
Actual Size

### TOPPERS

Control panel styling and appearance can be changed by adding an auxiliary "Topper" button, as described on page 19.



### BUTTONS

| HEIGHT "A"      | PART NO.   | REMARKS  |
|-----------------|------------|----------|
| .344" (8.74mm)  | G-02-75-A1 | Standard |
| .188" (4.78mm)  | G-02-75-A5 | Optional |
| .406" (10.31mm) | G-02-75-A6 | Optional |
| .500" (12.70mm) | G-02-75-A2 | Optional |
| .625" (15.88mm) | G-02-75-A4 | Optional |
| .750" (19.05mm) | G-02-75-A3 | Optional |
| .344" (8.74mm)  | G-02-73-1  | Optional |
| .188" (4.78mm)  | G-02-73-5  | Optional |
| .406" (10.31mm) | G-02-73-6  | Optional |
| .500" (12.70mm) | G-02-73-2  | Optional |
| .625" (15.88mm) | G-02-73-4  | Optional |
| .750" (19.05mm) | G-02-73-3  | Optional |
| .031" (.79mm)   | G-02-150   | Optional |
| .125" (3.18mm)  | G-02-150-1 | Optional |
| .220" (5.59mm)  | G-02-150-2 | Optional |
| .750" (19.05mm) | G-02-25    | Optional |
| .500" (12.70mm) | G-02-80    | Optional |
| .090" (2.29mm)  | G-02-102*  | Optional |

\*Specify GB-323 or GB-324 when G-02-102 button required.



# Slide Switch-Standard



## MOUNTING

**STANDARD** • Two .140" diameter holes on 1.125" centers. 6-32 and 4-40 extruded and tapped mounting holes also are available.

**PRINTED CIRCUIT BOARD** • Plug directly into board having suggested hole pattern for terminal arrangement you choose. Standard is "in-line" terminals that mate with top PC layout. Staggered terminals, mate with bottom PC layout and provide greater stability on the circuit board prior to soldering. Specify if desired.

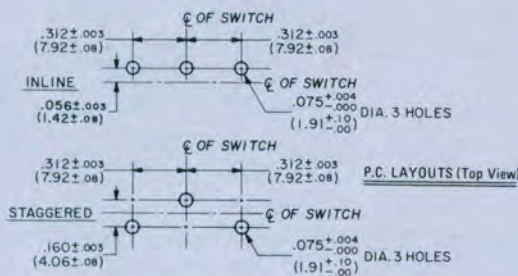

**TWIST TAB** • Mount to .031"-.047" thick metal chassis by specifying housing G-01-112. Housing ears, when twisted in chassis cutout shown, lock switch into place.



## TERMINALS

Standard is solder terminal G-20-30 as shown. For P.C. applications, we suggest terminal G-20-13 and for wire wrap terminations, we recommend terminal G-20-23. You may select other terminals best suited for your applications as shown in drawing T-4 on page 11.

## PROTECTIVE NYLON SHIELDS

A nylon shield that is easily snapped on to switch for wiring protection is available. Identify as G-40-07. See drawing at right.

## LEAD WIRES

SPST and SPDT switches are available with wire leads fastened to terminals as shown in drawing at right. Standard leads are 3 inch # 18 gauge leads (16/30 wire) having .032" thick 105°C U.L. insulation. Special wires and lengths are available. Also shown is shield G-40-08 which, when snapped onto switch, electrically isolates each wire.

## SOLDER SHIELD (G-29-046)

Vulcanized fiber shield .020" thick that fits over "in-line" switch terminals may be shipped assembled or separate, as you specify.

## ROCKER SWITCHES

All of these switches, when combined with bracket and knob assembly, become CW rocker switches. See pages 33-34.

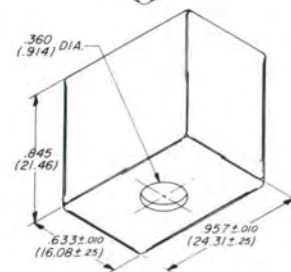
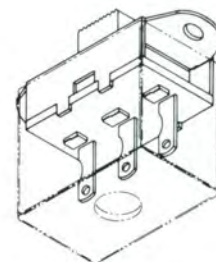

G-40-07



# Slide Switch-Standard

- GDD-323 SINGLE POLE/SINGLE THROW (with detent)
- GDD-324 SINGLE POLE/DOUBLE THROW (with detent)
- GDD-326 DOUBLE POLE/DOUBLE THROW (with detent)

| TYPE          | ELECTRICAL RATING         | LISTING       |
|---------------|---------------------------|---------------|
| GDD-323-SPST  | 3.0A AC, 0.5A DC at 125V  | U.L. & C.S.A. |
| GDD-623-SPST  | 6.0A AC, 0.5A DC at 125V  | U.L. & C.S.A. |
| GDD-1123-SPST | 11.0A AC, 0.5A DC at 125V | U.L. & C.S.A. |
| GDD-324-SPDT  | 3.0A AC, 0.5A DC at 125V  | U.L. & C.S.A. |
| GDD-624-SPDT  | 6.0A AC, 0.5A DC at 125V  | U.L. & C.S.A. |
| GDD-1124-SPDT | 11.0A AC, 0.5A DC at 125V | U.L. & C.S.A. |
| GDD-326       | 3.0A AC, 0.5A DC at 125V  | U.L. & C.S.A. |

## FEATURES

- Patented detent mechanism for positive detent action.
- Tease proof snap action.
- Self-cleaning wiping contacts.
- Switches up to 11.0 amps - 125 volts AC.



Button height options are .500" (12.70mm); .625" (15.88mm) and .750" (19.05mm)

## TERMINALS

Standard is solder terminal G-20-30 shown. For PC Board termination, we suggest G-20-13; for wire wrap, G-20-23; and for solderless connectors G-20-35. See page 11 for additional options.

## SOLDER SHIELD

Vulcanized fiber shield .020" thick that fits over switch terminals may be shipped assembled or separate as you specify. For single pole switch, specify G-29-046 inline only. For double pole switch, specify G-29-022.

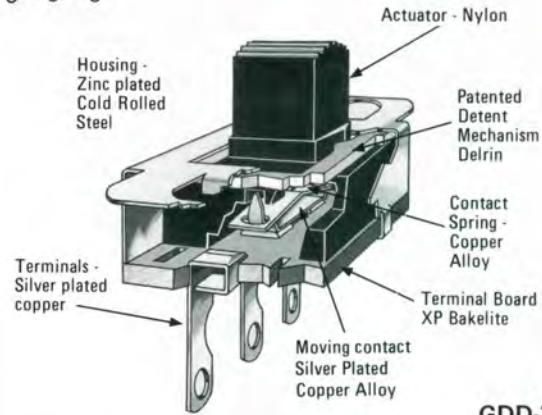
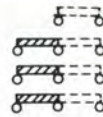

GDD-324

There's no doubt about "where you are" when you use our new "GDD" switch series with its patented positive detent action . . . one position or the other! You can "feel" the difference when this switch "snaps" from position to position. Use it in home appliances, instruments, industrial controls, automobiles, or office machines . . . wherever a positive teaseproof snap-action is desired.

## MOUNTING

**STANDARD** • Two .140" holes on 1.125" centers.

**PRINTED CIRCUIT BOARD** • Plug directly into printed circuit board having hole pattern mating with your switch terminals. Standard GDD 324 single pole terminal orientation is "in line." For greater switch stability on your P. C. Board before soldering, specify staggered terminals as shown on Page 7.



## TOPPERS

Control panel styling and appearance can be changed by adding an auxiliary "Topper" button as described on page 19. Switch mates with G-02-72-6 only.



# Slide Switch-Standard



## GM-311 MOMENTARY NORMALLY OPEN SINGLE POLE SINGLE THROW SWITCH

**TYPE**  
GM-311-SPST

**ELECTRICAL RATING**  
3.0A AC, 0.5A DC at 125V

**LISTING**  
U.L. and CSA



**GM-311**  
Actual Size

Switch GM-311 is a push-type momentary switch, the circuit normally open. As the button is depressed downward the electrical circuit is completed and remains closed until button is released.



### TERMINAL OPTIONS

Standard is G-20-35-8 as shown, and is suitable for use with a .110 type push on connector. Choose other terminals as needed from Table T-4, Page 11.

### MOUNTING

Standard is two .138" ± .001 (3.51 ± .05 mm) holes on 1.125" (28.58mm) centers as shown.

G-331 SINGLE POLE/SINGLE THROW (spring return)   
 G-332 SINGLE POLE/DOUBLE THROW (spring return) 

| TYPE   | ELECTRICAL RATING            | LISTING       |
|--------|------------------------------|---------------|
| G-331  | 3.0 A AC, 0.5 A DC at 125 V  | U.L. & C.S.A. |
| G-631  | 6.0 A AC, 0.5 A DC at 125 V  | U.L. & C.S.A. |
| G-831  | 8.0 A DC at 12 V             |               |
| G-1131 | 11.0 A AC, 0.5 A DC at 125 V | U.L. & C.S.A. |
| G-1331 | 13.0 A AC, 0.5 A DC at 125 V | U.L. & C.S.A. |
| G-332  | 3.0 A AC, 0.5 A DC at 125 V  | U.L. & C.S.A. |
| G-632  | 6.0 A AC, 0.5 A DC at 125 V  | U.L. & C.S.A. |
| G-832  | 8.0 A DC at 12 V             |               |
| G-1132 | 11.0 A AC, 0.5 A DC at 125 V | U.L. & C.S.A. |
| G-1332 | 13.0 A AC, 0.5 A DC at 125 V | U.L. & C.S.A. |



G-332  
Actual Size



All switch types shown are illustrated in drawing. Single pole single throw versions have one end terminal (shown in blue) removed.

Provision for varying current and voltage rating is made by changing internal contact materials. Switches with "spring return" action have internal spring. A force on the switch button moves the button (and contact) from one position to the other. When that force on the button is removed, the spring will force the button (and contact) to return to their original position.

### TOPPERS

Control panel styling and appearance can be changed by adding an auxiliary "Topper" button, as described on page 18.

### SOLDER SHIELD (G-29-046)

Vulcanized fiber shield .020" thick that fits over "in-line" switch terminals may be shipped assembled or separate, as you specify.

### BUTTONS

| HEIGHT "A"      | PART NO.    | REMARKS  |
|-----------------|-------------|----------|
| .344" (8.74mm)  | G-02-177-A1 | Standard |
| .188" (4.78mm)  | G-02-177-A5 | Optional |
| .406" (10.31mm) | G-02-177-A6 | Optional |
| .500" (12.70mm) | G-02-177-A2 | Optional |
| .625" (15.88mm) | G-02-177-A4 | Optional |
| .750" (19.05mm) | G-02-177-A3 | Optional |
| .344" (8.74mm)  | G-02-178-1  | Optional |
| .188" (4.78mm)  | G-02-178-5  | Optional |
| .406" (10.31mm) | G-02-178-6  | Optional |
| .500" (12.70mm) | G-02-178-2  | Optional |
| .625" (15.88mm) | G-02-178-4  | Optional |
| .750" (19.05mm) | G-02-178-3  | Optional |
| .031" (.79mm)   | G-02-150    | Optional |
| .125" (3.18mm)  | G-02-150-1  | Optional |
| .220" (5.59mm)  | G-02-150-2  | Optional |
| .500" (12.70mm) | G-02-80     | Optional |



G-02-177-A



G-02-178



G-02-150



G-02-80

# Slide Switch-Standard



## MOUNTING

**STANDARD** • Two .140" diameter holes on 1.125" centers. 6-32 and 4-40 extruded and tapped mounting holes also are available.

**PRINTED CIRCUIT BOARD** • Plug directly into board having suggested hole pattern for terminal arrangement you choose. Standard is "in-line" terminals that mate with top PC layout. Staggered terminals mate with bottom PC layout and provide greater stability on the circuit board prior to soldering. Specify if desired.

**TWIST TAB** • Mount to .031"-.047" thick metal chassis by specifying housing G-01-112. Housing ears, when twisted in chassis cutout shown, lock switch into place.



## TERMINALS

Standard is solder terminal G-20-30 as shown. For P.C. applications, we suggest terminal G-20-13 and for wire wrap terminations, we recommend terminal G-20-23. You may select other terminals best suited for your application as shown in drawing T-4.



### TERMINAL PART NUMBERS

| DIMEN. | G-20-13                      | G-20-23                      | G-20-26                      | G-20-27                      | G-20-30                      | G-20-31                      | G-20-33                      | G-20-35                      | G-20-42                      | G-20-48                      | G-20-50                      |
|--------|------------------------------|------------------------------|------------------------------|------------------------------|------------------------------|------------------------------|------------------------------|------------------------------|------------------------------|------------------------------|------------------------------|
| A      | .440 ± .015<br>(11.18 ± .38) | .440 ± .015<br>(11.18 ± .38) | .403 ± .015<br>(10.24 ± .38) | .465 ± .015<br>(11.81 ± .38) | .670 ± .015<br>(17.02 ± .38) | .570 ± .015<br>(14.48 ± .38) | .670 ± .015<br>(17.02 ± .38) | .622 ± .015<br>(15.80 ± .38) | .712 ± .015<br>(18.08 ± .38) | .525 ± .015<br>(13.34 ± .38) | .625 ± .015<br>(15.88 ± .38) |
| B      | .130 ± .010<br>(3.30 ± .25)  | .130 ± .010<br>(3.30 ± .25)  | .093 ± .010<br>(2.36 ± .25)  | .155 ± .020<br>(3.94 ± .51)  | .360 ± .020<br>(9.14 ± .51)  | .260 ± .020<br>(6.60 ± .51)  | .360 ± .020<br>(9.14 ± .51)  | .312 ± .020<br>(7.92 ± .51)  | .402 ± .010<br>(10.21 ± .25) | .215 ± .010<br>(5.46 ± .25)  | .315 ± .020<br>(8.00 ± .51)  |
| C      | .125<br>(3.18)               | .125<br>(3.18)               | .125<br>(3.18)               | .125<br>(3.18)               | .125<br>(3.18)               | .125<br>(3.18)               | .125<br>(3.18)               | .125<br>(3.18)               | .125<br>(3.18)               | .125<br>(3.18)               | .125<br>(3.18)               |
| D      | .060<br>(1.52)               | .064<br>(1.63)               | .060<br>(1.52)               | ---                          | ---                          | ---                          | ---                          | .111<br>(2.82)               | .060<br>(1.52)               | .060<br>(1.52)               | ---                          |
| E      | .170<br>(4.32)               | .390<br>(9.91)               | .210<br>(5.33)               | ---                          | ---                          | ---                          | ---                          | ---                          | .170<br>(4.32)               | .170<br>(4.32)               | ---                          |

## ROCKER SWITCHES

All of these switches, when combined with bracket and knob assembly, become CW rocker switches. See pages 33-34.

## LEAD WIRES

These switches are available with wire leads fastened to terminals as shown on page 7. Standard leads are 3 inch # 18 gauge leads (16/30 wire) having .032" thick 105°C U.L. insulation. Special wires and lengths are available.

**GF-325 DOUBLE POLE/SINGLE THROW (with detent)**  
**GF-326 DOUBLE POLE/DOUBLE THROW (with detent)**

| TYPE    | ELECTRICAL RATING            | LISTING       |
|---------|------------------------------|---------------|
| GF-325  | 3.0 A AC, 0.5 A DC at 125 V  | U.L. & C.S.A. |
| GF-625  | 6.0 A AC, 0.5 A DC at 125 V  | U.L. & C.S.A. |
| GF-825  | 8.0 A DC at 12 V             |               |
| GF-1125 | 11.0 A AC, 0.5 A DC at 125 V | U.L. & C.S.A. |
| GF-1325 | 13.0 A AC, 0.5 A DC at 125 V | U.L. & C.S.A. |
| GF-1625 | 3.0 A AC at 125 V "L Rated"  | U.L.          |
| GF-326  | 3.0 A AC, 0.5 A DC at 125 V  | U.L. & C.S.A. |
| GF-626  | 6.0 A AC, 0.5 A DC at 125 V  | U.L. & C.S.A. |
| GF-826  | 8.0 A DC at 12 V             |               |
| GF-1126 | 11.0 A AC, 0.5 A DC at 125 V | U.L. & C.S.A. |
| GF-1326 | 13.0 A AC, 0.5 A DC at 125 V | U.L. & C.S.A. |
| GF-1626 | 3.0 A AC at 125 V "L Rated"  | U.L.          |



**GF-326**  
Actual Size

### BUTTONS

| HEIGHT "A"      | PART NO.   | REMARKS  |
|-----------------|------------|----------|
| .344" (8.74mm)  | G-02-76-A1 | Standard |
| .188" (4.78mm)  | G-02-76-A5 | Optional |
| .406" (10.31mm) | G-02-76-A6 | Optional |
| .500" (12.70mm) | G-02-76-A2 | Optional |
| .625" (15.88mm) | G-02-76-A4 | Optional |
| .750" (19.05mm) | G-02-76-A3 | Optional |
| .344" (8.74mm)  | G-02-74-1  | Optional |
| .188" (4.78mm)  | G-02-74-5  | Optional |
| .406" (10.31mm) | G-02-74-6  | Optional |
| .500" (12.70mm) | G-02-74-2  | Optional |
| .625" (15.88mm) | G-02-74-4  | Optional |
| .750" (19.05mm) | G-02-74-3  | Optional |
| .031" (.79mm)   | G-02-153   | Optional |
| .125" (3.18mm)  | G-02-153-1 | Optional |
| .220" (5.59mm)  | G-02-153-2 | Optional |
| .750" (19.05mm) | G-02-26    | Optional |
| .500" (12.70mm) | G-02-65    | Optional |
| .090" (2.29mm)  | G-02-107*  | Optional |

\*Specify GB-325 or GB-326 when G-02-107 button is required.



Double pole single throw versions have two terminals (shown in blue) removed. Provision for varying current and voltage rating is made by changing internal contact materials.

### TOPPERS

Control panel styling and appearance can be changed by adding an auxiliary "Topper" button, as described on page 18.



# Slide Switch-Standard



## MOUNTING

**STANDARD** • Two .140" diameter holes on 1.125" centers. 6-32 and 4-40 extruded and tapped mounting holes also are available.

**PRINTED CIRCUIT BOARD** • Plug directly into board having hole pattern shown in drawing below.



**TWIST TAB** • Mount to .031" thick metal chassis by specifying housing G-01-112. Housing ears, when twisted in chassis cutout shown, lock switch into place. See drawing on page 11.

## PUSH-PULL

You may find it more convenient to actuate your switch from the front, with the actuating button protruding through the panel. See drawing below.

| LENGTH "B"       | PART NO.  |
|------------------|-----------|
| .884" (22.45mm)  | G-02-59   |
| 1.134" (28.80mm) | G-02-59-6 |
| 1.312" (33.32mm) | G-02-59-7 |
| 1.512" (38.40mm) | G-02-59-9 |
| 2.226" (56.54mm) | G-02-59-8 |



## PROTECTIVE NYLON SHIELDS

A nylon shield that is easily snapped on to switch for wiring protection is available. Identify as G-40-07. See page 7.

## ROCKER SWITCHES

All of these switches, when combined with bracket and knob assembly, become CW rocker switches. See pages 33-34.

## SOLDER SHIELD (G-29-022)

Vulcanized fiber shield .020" thick that fits over the switch terminals may be shipped assembled or separate, as you specify.

## TERMINALS

Standard is solder terminal G-20-30 as shown. For P.C. applications, we suggest terminal G-20-13 and for wire wrap terminations, we recommend terminal G-20-23. You may select other terminals best suited for your application as shown in drawing T-4.



### TERMINAL NUMBERS

| DIMEN. | G-20-13                      | G-20-23                      | G-20-26                      | G-20-27                      | G-20-30                      | G-20-31                      | G-20-33                      | G-20-35                      | G-20-42                      | G-20-48                      | G-20-50                      |
|--------|------------------------------|------------------------------|------------------------------|------------------------------|------------------------------|------------------------------|------------------------------|------------------------------|------------------------------|------------------------------|------------------------------|
| A      | .440 ± .015<br>(11.18 ± .38) | .440 ± .015<br>(11.18 ± .38) | .403 ± .015<br>(10.24 ± .38) | .465 ± .015<br>(11.81 ± .38) | .670 ± .015<br>(17.02 ± .38) | .570 ± .015<br>(14.48 ± .38) | .670 ± .015<br>(17.02 ± .38) | .622 ± .015<br>(15.80 ± .38) | .712 ± .015<br>(18.08 ± .38) | .525 ± .015<br>(13.34 ± .38) | .625 ± .015<br>(15.88 ± .38) |
| B      | .130 ± .010<br>(3.30 ± .25)  | .130 ± .010<br>(3.30 ± .25)  | .093 ± .010<br>(2.36 ± .25)  | .155 ± .020<br>(3.94 ± .51)  | .360 ± .020<br>(9.14 ± .51)  | .260 ± .020<br>(6.60 ± .51)  | .360 ± .020<br>(9.14 ± .51)  | .312 ± .020<br>(7.92 ± .51)  | .402 ± .010<br>(10.21 ± .25) | .215 ± .010<br>(5.46 ± .25)  | .315 ± .020<br>(8.00 ± .51)  |
| C      | .125<br>(3.18)               | .125<br>(3.18)               | .125<br>(3.18)               | .125<br>(3.18)               | .125<br>(3.18)               | .125<br>(3.18)               | .125<br>(3.18)               | .125<br>(3.18)               | .125<br>(3.18)               | .125<br>(3.18)               | .125<br>(3.18)               |
| D      | .060<br>(1.52)               | .064<br>(1.63)               | .060<br>(1.52)               | ---                          | ---                          | ---                          | ---                          | .111<br>(2.82)               | .060<br>(1.52)               | .060<br>(1.52)               | ---                          |
| E      | .170<br>(4.32)               | .390<br>(9.91)               | .210<br>(5.33)               | ---                          | ---                          | ---                          | ---                          | ---                          | .170<br>(4.32)               | .170<br>(4.32)               | ---                          |



# Slide Switch-Standard

## G-375A DOUBLE POLE/DOUBLE THROW (spring return)

**ELECTRICAL RATING**      **LISTING**  
 3.0 A AC, 0.5 A DC at 125 V      U.L. & C.S.A.



**G-375A**  
Actual Size

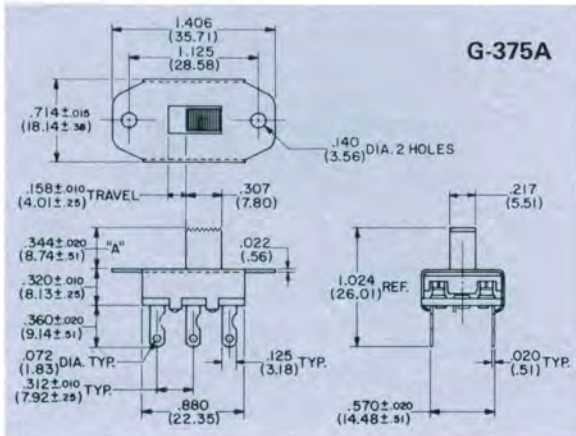

### MOUNTING

**STANDARD** • Two .140" diameter holes on 1.125" centers. 6-32 extruded and tapped mounting holes also are available.

**PRINTED CIRCUIT BOARD** • Plug directly into board having hole pattern shown.

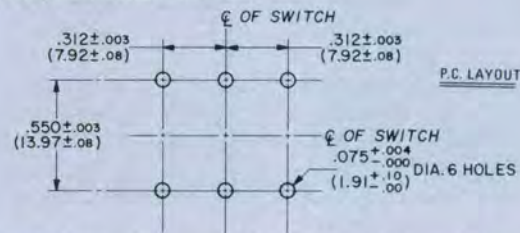

**TWIST TAB** • Mount to .031"-.047" thick metal chassis by specifying bracket G-10-11. Housing ears, when twisted in chassis cutout shown, lock switch into place. See drawing on page 16.

### BUTTONS

| HEIGHT "A"      | PART NO.   | REMARKS  |
|-----------------|------------|----------|
| .344" (8.74mm)  | G-02-192   | Standard |
| .188" (4.78mm)  | G-02-192-2 | Optional |
| .406" (10.31mm) | G-02-192-3 | Optional |
| .500" (12.70mm) | G-02-192-4 | Optional |
| .625" (15.88mm) | G-02-192-5 | Optional |
| .750" (19.05mm) | G-02-192-6 | Optional |

### ROCKER SWITCHES

This switch, when combined with bracket and knob assembly, become CW rocker switch. See pages 33-34.

### TERMINALS

Standard is solder terminal G-20-30 as shown. For P.C. applications, we suggest terminal G-20-13 and for wire wrap terminations, we recommend terminal G-20-23. You may select other terminals best suited for your application as shown in drawing T-4.

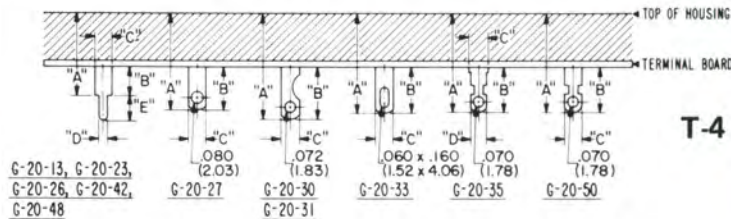

### TERMINAL PART NUMBERS

| DIMEN. | G-20-13                       | G-20-23                       | G-20-26                       | G-20-27                       | G-20-30                       | G-20-31                       | G-20-33                       | G-20-35                       | G-20-42                       | G-20-48                       | G-20-50                       |
|--------|-------------------------------|-------------------------------|-------------------------------|-------------------------------|-------------------------------|-------------------------------|-------------------------------|-------------------------------|-------------------------------|-------------------------------|-------------------------------|
| A      | .450 ± .015*<br>(11.43 ± .38) | .450 ± .015*<br>(11.43 ± .38) | .413 ± .015*<br>(10.49 ± .38) | .475 ± .015*<br>(12.07 ± .38) | .680 ± .015*<br>(17.27 ± .38) | .580 ± .015*<br>(14.73 ± .38) | .680 ± .015*<br>(17.27 ± .38) | .632 ± .015*<br>(16.05 ± .38) | .722 ± .015*<br>(18.34 ± .38) | .635 ± .015*<br>(16.13 ± .38) | .635 ± .015*<br>(16.13 ± .38) |
| B      | .130 ± .010<br>(3.30 ± .25)   | .130 ± .010<br>(3.30 ± .25)   | .093 ± .010<br>(2.36 ± .25)   | .155 ± .020<br>(3.94 ± .51)   | .360 ± .020<br>(9.14 ± .51)   | .260 ± .020<br>(6.60 ± .51)   | .360 ± .020<br>(9.14 ± .51)   | .312 ± .020<br>(7.92 ± .51)   | .402 ± .010<br>(10.21 ± .25)  | .215 ± .010<br>(5.46 ± .25)   | .315 ± .020<br>(8.00 ± .51)   |
| C      | .125<br>(3.18)                | .125<br>(3.18)                | .125<br>(3.18)                | .125<br>(3.18)                | .125<br>(3.18)                | .125<br>(3.18)                | .125<br>(3.18)                | .125<br>(3.18)                | .125<br>(3.18)                | .125<br>(3.18)                | .125<br>(3.18)                |
| D      | .060<br>(1.52)                | .064<br>(1.63)                | .060<br>(1.52)                | ---                           | ---                           | ---                           | ---                           | .111<br>(2.82)                | .060<br>(1.52)                | .060<br>(1.52)                | ---                           |
| E      | .170<br>(4.32)                | .390<br>(9.91)                | .210<br>(5.33)                | ---                           | ---                           | ---                           | ---                           | ---                           | .170<br>(4.32)                | .170<br>(4.32)                | ---                           |

\*For GF-342 switches, add .010" to height shown.

# Slide Switch-Standard



## THREE POLE/DOUBLE THROW (with detent)

| TYPE    | ELECTRICAL RATING                         |
|---------|---|
| GF-361  | 3.0 A AC, 0.5 A DC at 125 V               |
| GF-661  | 6.0 A AC, 0.5 A DC at 125 V               |
| GF-861  | 8.0 A DC at 12 V                          |
| GF-1161 | 11.0 A AC, 0.5 A DC at 125 V (22 A total) |
| GF-1361 | 13.0 A AC, 0.5 A DC at 125 V (26 A total) |

| LISTING       |
|---------------|
| U.L. & C.S.A. |
| U.L. & C.S.A. |
| U.L. & C.S.A. |
| U.L. & C.S.A. |



GF-361  
Actual Size



## BUTTONS

| HEIGHT "A"      | PART NO.  | REMARKS  |
|-----------------|-----------|----------|
| .344" (8.74mm)  | G-02-61   | Standard |
| .188" (4.78mm)  | G-02-61-3 | Optional |
| .406" (10.31mm) | G-02-61-4 | Optional |
| .500" (12.70mm) | G-02-61-1 | Optional |
| .625" (15.88mm) | G-02-61-5 | Optional |
| .750" (19.05mm) | G-02-61-2 | Optional |
| .032" (.81mm)   | G-02-61-9 | Optional |
| .500" (12.70mm) | G-02-97   | Optional |
| .344" (8.74mm)  | G-02-137  | Optional |

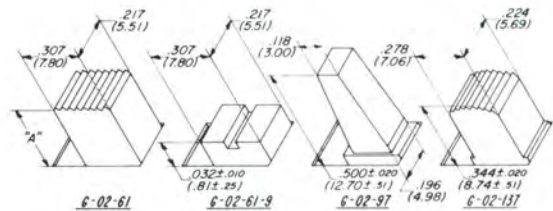

## MOUNTING

**STANDARD** • Two .140" diameter holes on 1.125" centers. 6-32 extruded and tapped mounting holes also are available.

**PRINTED CIRCUIT BOARD** • Plug directly into board having hole pattern below.

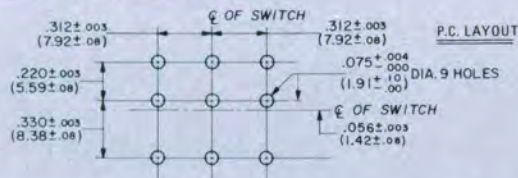

## TOPPERS

Control panel styling and appearance can be changed by adding an auxiliary "Topper" button, as described on page 18.

## SOLDER SHIELD (G-29-017)

Vulcanized fiber shield .020" thick that fits over switch terminals may be shipped assembled or separate, as you specify.

## TERMINALS

Standard is G-20-30. Specify any terminal shown in drawing T-4 on page 15 that is best for your application.

## ROCKER SWITCHES

All of these switches, when combined with bracket and knob assembly, become CW rocker switches. See pages 33-34.



# Slide Switch-Standard

## FOUR POLE/DOUBLE THROW (with detent)

| TYPE    | ELECTRICAL RATING                         | LISTING       |
|---------|---|---------------|
| GF-342  | 3.0 A AC, 0.5 A DC at 125 V               | U.L. & C.S.A. |
| GF-642  | 6.0 A AC, 0.5 A DC at 125 V               | U.L. & C.S.A. |
| GF-842  | 8.0 A DC at 12 V                          |               |
| GF-1142 | 11.0 A AC, 0.5 A DC at 125 V (22 A total) | U.L. & C.S.A. |
| GF-1342 | 13.0 A AC, 0.5 A DC at 125 V (26 A total) | U.L. & C.S.A. |



GF-342  
Actual Size



## BUTTONS

| HEIGHT "A"      | PART NO.  | REMARKS  |
|-----------------|-----------|----------|
| .344" (8.74mm)  | G-02-84   | Standard |
| .188" (4.78mm)  | G-02-84-4 | Optional |
| .406" (10.31mm) | G-02-84-5 | Optional |
| .500" (12.70mm) | G-02-84-1 | Optional |
| .625" (15.88mm) | G-02-84-3 | Optional |
| .750" (19.05mm) | G-02-84-2 | Optional |
| .032" (.81mm)   | G-02-109  | Optional |
| .344" (8.74mm)  | G-02-136  | Optional |

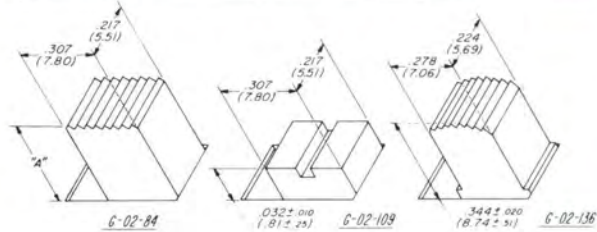

## MOUNTING

**STANDARD** • Two .140" diameter holes on 1.125" centers. 4-40 extruded and tapped mounting holes also are available.

**PRINTED CIRCUIT BOARD** • Plug directly into board having hole pattern suggested.



## TERMINALS

Standard is G-20-30. Specify any terminal shown in drawing T-4 on page 15 that is best for your application.

## TOPPERS

Control panel styling and appearance can be changed by adding an auxiliary "Topper" button, as described on page 18.

## ROCKER SWITCHES

All of these switches, when combined with bracket and knob assembly, become CW rocker switches. See pages 33-34.

## SOLDER SHIELD (G-29-043)

Vulcanized fiber shield .020" thick that fits over the switch terminals may be shipped assembled or separate, as you specify.



# Slide Switch-Standard



## SINGLE POLE/THREE POSITION (with detent)

| TYPE     | ELECTRICAL RATING            | LISTING       |
|----------|------------------------------|---------------|
| G-329-L  | 3.0 A AC, 0.5 A DC at 125 V  | U.L. & C.S.A. |
| G-329-S  | 3.0 A AC, 0.5 A DC at 125 V  | U.L. & C.S.A. |
| G-629-L  | 6.0 A AC, 0.5 A DC at 125 V  | U.L. & C.S.A. |
| G-629-S  | 6.0 A AC, 0.5 A DC at 125 V  | U.L. & C.S.A. |
| G-829-L  | 8.0 A DC at 12 V             | U.L. & C.S.A. |
| G-829-S  | 8.0 A DC at 12 V             | U.L. & C.S.A. |
| G-1129-L | 11.0 A AC, 0.5 A DC at 125 V | U.L. & C.S.A. |
| G-1129-S | 11.0 A AC, 0.5 A DC at 125 V | U.L. & C.S.A. |
| G-1329-L | 13.0 A AC, 0.5 A DC at 125 V | U.L. & C.S.A. |
| G-1329-S | 13.0 A AC, 0.5 A DC at 125 V | U.L. & C.S.A. |



G-329-S  
(with staggered terminals)

Actual Size



More positive detenting in the center position is attained by dual detenting with both the spring in the moving contact and the loop in the button or detent plate directly mating with slots in the switch housing. Switch shown in drawing is with button in extreme right position. Even in this position, the long detent plate covers the entire opening on the top of the housing and extends outside the end of the housing, as shown. If covering the opening at the top of the switch, when the actuating button is in the end position, is not necessary, specify G-329-S. Drawing of G-329-S would have short detent plate as indicated by blue line in top view and would have no extension outside the end of the switch housing, also shown in blue.

### BUTTONS

| HEIGHT "A"      | PART NO.   | REMARKS  |
|-----------------|------------|----------|
| .344" (8.74mm)  | G-02-75-A1 | Standard |
| .188" (4.78mm)  | G-02-75-A5 | Optional |
| .406" (10.31mm) | G-02-75-A6 | Optional |
| .500" (12.70mm) | G-02-75-A2 | Optional |
| .625" (15.88mm) | G-02-75-A4 | Optional |
| .750" (19.05mm) | G-02-75-A3 | Optional |
| .344" (8.74mm)  | G-02-73-1  | Optional |
| .188" (4.78mm)  | G-02-73-5  | Optional |
| .406" (10.31mm) | G-02-73-6  | Optional |
| .500" (12.70mm) | G-02-73-2  | Optional |
| .625" (15.88mm) | G-02-73-4  | Optional |
| .750" (19.05mm) | G-02-73-3  | Optional |
| .031" (.79mm)   | G-02-150   | Optional |
| .125" (3.18mm)  | G-02-150-1 | Optional |
| .220" (5.59mm)  | G-02-150-2 | Optional |
| .500" (12.70mm) | G-02-80    | Optional |



G-02-75-A



G-02-73



G-02-150



G-02-80

### SOLDER SHIELD (G-29-004)

Vulcanized fiber shield .020" thick that fits over in-line switch terminals may be shipped assembled or separate, as you specify.

## TOPPERS (G-02-69, G-02-72, G-02-317 and G-02-329)

Control panel styling and appearance can be changed by adding an auxiliary "Topper" button. Standard color is black, but it is available in other colors described on back page. Be certain to allow enough clearance between top of switch and bottom of Topper by selecting correct switch button height.



| BUTTON HEIGHT | DIM. "C"    |
|---------------|-------------|
| .344 (8.74)   | ---         |
| .406 (10.31)  | ---         |
| .625 (15.88)  | .126 (3.20) |
| .750 (19.05)  | .251 (6.38) |

For .307" width button only

| BUTTON HEIGHT | DIM. "C"     |
|---------------|--------------|
| .344 (8.74)   | .138 (3.51)  |
| .406 (10.31)  | .200 (5.08)  |
| .500 (12.70)  | .296 (7.52)  |
| .625 (15.88)  | .419 (10.64) |
| .750 (19.05)  | .544 (13.82) |



\*.115±.010 STANDARD WITH .344 BUTTON HEIGHT, VARIES WITH BUTTON HEIGHT.

For .307" width button specify G-02-72

For .278" width button specify G-02-72-6



\*.115±.010 STANDARD WITH .344 BUTTON HEIGHT, VARIES WITH BUTTON HEIGHT.

For .278" width button only.

| BUTTON HEIGHT | DIM. "C"     |
|---------------|--------------|
| .344 (8.74)   | .115 (2.92)  |
| .406 (10.31)  | .177 (4.50)  |
| .500 (12.70)  | .271 (6.88)  |
| .625 (15.88)  | .396 (10.06) |
| .750 (19.05)  | .521 (13.23) |

For .278" width button only.

## G-02-329



\*.138±.010 STANDARD WITH .344 BUTTON HEIGHT, VARIES WITH BUTTON HEIGHT.

## MOUNTING

**STANDARD** • Two .140" diameter holes on 1.406" centers. 6-32 extruded and tapped holes are also available.  
**PRINTED CIRCUIT BOARD** • Plug directly into board having suggested hole pattern for terminal arrangement you choose. Standard is "in-line" terminals shown in in-line PC layout. Staggered terminals that mate with "staggered" layout, provide greater stability on the circuit board prior to soldering. Specify if desired.



## TERMINALS

Standard is solder terminal G-20-30 as shown. For PC applications, we suggest terminal G-20-13 and for wire wrap terminations, we recommend terminal G-20-23. You may select other terminals best suited for your application as shown in drawing T-4.

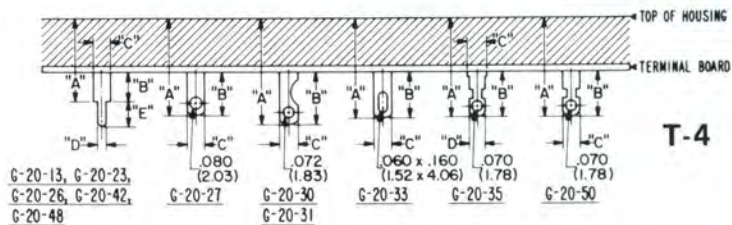

### TERMINAL PART NUMBERS

| DIMEN. | G-20-13                      | G-20-23                      | G-20-26                      | G-20-27                      | G-20-30                      | G-20-31                      | G-20-33                      | G-20-35                      | G-20-42                      | G-20-48                      | G-20-50                      |
|--------|------------------------------|------------------------------|------------------------------|------------------------------|------------------------------|------------------------------|------------------------------|------------------------------|------------------------------|------------------------------|------------------------------|
| A      | .450 ± .015<br>(11.43 ± .38) | .450 ± .015<br>(11.43 ± .38) | .413 ± .015<br>(10.49 ± .38) | .475 ± .015<br>(12.07 ± .38) | .680 ± .015<br>(17.27 ± .38) | .580 ± .015<br>(14.73 ± .38) | .680 ± .015<br>(17.27 ± .38) | .632 ± .015<br>(16.05 ± .38) | .722 ± .015<br>(18.34 ± .38) | .535 ± .015<br>(13.59 ± .38) | 6.35 ± .015<br>(16.13 ± .38) |
| B      | .130 ± .010<br>(3.30 ± .25)  | .130 ± .010<br>(3.30 ± .25)  | .093 ± .010<br>(2.36 ± .25)  | .155 ± .020<br>(3.94 ± .51)  | .360 ± .020<br>(9.14 ± .51)  | .260 ± .020<br>(6.60 ± .51)  | .360 ± .020<br>(9.14 ± .51)  | .312 ± .020<br>(7.92 ± .51)  | .402 ± .010<br>(10.21 ± .25) | .215 ± .010<br>(5.46 ± .25)  | .315 ± .020<br>(8.00 ± .51)  |
| C      | .125<br>(3.18)               | .125<br>(3.18)               | .125<br>(3.18)               | .125<br>(3.18)               | .125<br>(3.18)               | .125<br>(3.18)               | .125<br>(3.18)               | .125<br>(3.18)               | .125<br>(3.18)               | .125<br>(3.18)               | .125<br>(3.18)               |
| D      | .060<br>(1.52)               | .064<br>(1.63)               | .060<br>(1.52)               | ---                          | ---                          | ---                          | ---                          | .111<br>(2.82)               | .060<br>(1.52)               | .060<br>(1.52)               | ---                          |
| E      | .170<br>(4.32)               | .390<br>(9.91)               | .210<br>(5.33)               | ---                          | ---                          | ---                          | ---                          | ---                          | .170<br>(4.32)               | .170<br>(4.32)               | ---                          |

# Slide Switch-Standard



## SINGLE POLE/THREE POSITION (with detent)

| TYPE  | ELECTRICAL RATING                                | LISTING       |
|-------|--|---------------|
| G-490 | 4.0 A AC, 0.5 A DC at 125 V<br>1.0 A AC at 250 V | U.L. & C.S.A. |
| G-690 | 6.0 A AC, 0.5 A DC at 125 V<br>1.0 A AC at 250 V | U.L. & C.S.A. |



G-490L/S  
Actual Size



Switch shown in drawing is Type G-490L with button in extreme right position. The integral button cover closes the entire opening at the top of the switch and extends outside the end of the housing as shown in blue. If covering the opening at the top of switch is not necessary, specify G-490S. Drawing of G-490S has blue line in top view showing that extension outside the end of the switch housing is omitted.

### MOUNTING

**STANDARD** • Two .140" diameter holes on 1.125" centers, or plug directly into printed circuit board having suggested hole pattern.



### TERMINALS

Standard G-20-43 terminal is designed to mate with AMP 110 Connector or equivalent and also for easy soldering. G-20-51 printed circuit terminal is also available.



### SOLDER SHIELD (G-29-059)

Vulcanized fiber shields .020" thick that fit over switch terminals may be shipped assembled or separate, as you specify.

### BUTTONS

| HEIGHT "A"      | PART NO.   | REMARKS  |
|-----------------|------------|----------|
| .344" (8.74mm)  | G-02-110-1 | Standard |
| .406" (10.31mm) | G-02-110-2 | Optional |
| .625" (15.89mm) | G-02-110-3 | Optional |
| .750" (19.05mm) | G-02-110-4 | Optional |

### TOPPER (G-02-72-6)

Control panel styling and appearance can be changed by adding an auxiliary "Topper" button. This Topper mates with G-02-110 button series and is otherwise the same as Topper G-02-72 described on page 18.



# Slide Switch-Standard



## DOUBLE POLE/THREE POSITION (with detent)

| TYPE     | ELECTRICAL RATING            | LISTING       |
|----------|------------------------------|---------------|
| G-328-L  | 3.0 A AC, 0.5 A DC at 125 V  | U.L. & C.S.A. |
| G-328-S  | 3.0 A AC, 0.5 A DC at 125 V  | U.L. & C.S.A. |
| G-628-L  | 6.0 A AC, 0.5 A DC at 125 V  | U.L. & C.S.A. |
| G-628-S  | 6.0 A AC, 0.5 A DC at 125 V  | U.L. & C.S.A. |
| G-828-L  | 8.0 A DC at 12 V             |               |
| G-828-S  | 8.0 A DC at 12 V             |               |
| G-1128-L | 11.0 A AC, 0.5 A DC at 125 V | U.L. & C.S.A. |
| G-1128-S | 11.0 A AC, 0.5 A DC at 125 V | U.L. & C.S.A. |
| G-1328-L | 13.0 A AC, 0.5 A DC at 125 V | U.L. & C.S.A. |
| G-1328-S | 13.0 A AC, 0.5 A DC at 125 V | U.L. & C.S.A. |



G-328-S  
Actual Size

### BUTTONS

| HEIGHT "A"      | PART NO.   | REMARKS  |
|-----------------|------------|----------|
| .344" (8.74mm)  | G-02-76-A1 | Standard |
| .188" (4.78mm)  | G-02-76-A5 | Optional |
| .406" (10.31mm) | G-02-76-A6 | Optional |
| .500" (12.70mm) | G-02-76-A2 | Optional |
| .625" (15.88mm) | G-02-76-A4 | Optional |
| .750" (19.05mm) | G-02-76-A3 | Optional |
| .344" (8.74mm)  | G-02-74-1  | Optional |
| .188" (4.78mm)  | G-02-74-5  | Optional |
| .406" (10.31mm) | G-02-74-6  | Optional |
| .500" (12.70mm) | G-02-74-2  | Optional |
| .625" (15.88mm) | G-02-74-4  | Optional |
| .750" (19.05mm) | G-02-74-3  | Optional |
| .031" (.79mm)   | G-02-153   | Optional |
| .125" (3.18mm)  | G-02-153-1 | Optional |
| .220" (5.59mm)  | G-02-153-2 | Optional |
| .500" (12.70mm) | G-02-65    | Optional |

See page 12 for button drawings.

### PUSH-PULL

You may find it more convenient to actuate from the front of the switch with the actuating button protruding through your panel.

| LENGTH "B"       | PART NO.  |
|------------------|-----------|
| .563" (14.30mm)  | G-02-59-1 |
| .813" (20.65mm)  | G-02-59-2 |
| .993" (25.22mm)  | G-02-59-3 |
| 1.194" (30.33mm) | G-02-59-5 |
| 1.906" (48.41mm) | G-02-59-4 |

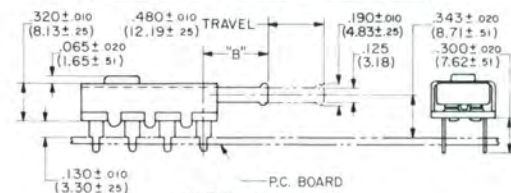

G-328 Push Pull

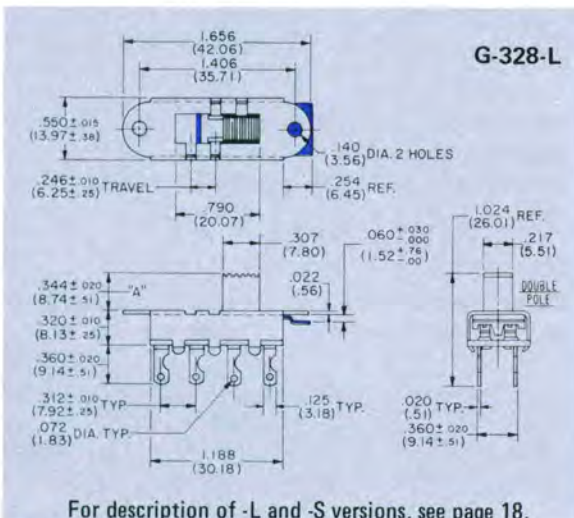

For description of -L and -S versions, see page 18.

### MOUNTING

**STANDARD** • Two .140" diameter holes on 1.406" centers. 6-32 extruded and tapped holes are also available.  
**PRINTED CIRCUIT BOARD** • Plug directly into suggested hole pattern.

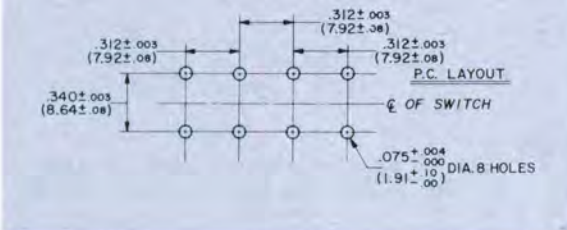

### TOPPERS

Control panel styling and appearance can be changed by adding an auxiliary "Topper" button as described on page 19.

### TERMINALS

Standard is solder terminal G-20-30 as shown. For PC applications, we suggest G-20-13 and for wire wrap terminations, we recommend terminal G-20-23. You may select other terminals best suited for your application as shown in drawing T-4 on page 20.

### ROCKER SWITCHES

All of these switches, when combined with bracket and knob assembly, become CW rocker switches. See pages 33.

### SOLDER SHIELD (G-29-041)

Vulcanized fiber shield .020" thick that fits over switch terminals may be shipped assembled or separate, as you specify.



# Slide Switch-Standard

**DOUBLE POLE/THREE POSITION** (spring return one end to center, detent to other end to center)



| TYPE    | ELECTRICAL RATING           | LISTING       |
|---------|-----------------------------|---------------|
| G-335-S | 3.0 A AC, 0.5 A DC at 125 V | U.L. & C.S.A. |
| G-635-S | 6.0 A AC, 0.5 A DC at 125 V | U.L. & C.S.A. |



G-335-S  
(With PC terminals)

Actual Size



## BUTTONS

| HEIGHT "A"      | PART NO.    | REMARKS  |
|-----------------|-------------|----------|
| .344" (8.74mm)  | G-02-192-1  | Standard |
| .188" (4.78mm)  | G-02-192-7  | Optional |
| .406" (10.31mm) | G-02-192-8  | Optional |
| .500" (12.70mm) | G-02-192-9  | Optional |
| .625" (15.88mm) | G-02-192-10 | Optional |

## SOLDER SHIELD (G-29-039)

Vulcanized fiber shield .020" thick that fits over switch terminals may be shipped assembled or separate, as you specify.

## TOPPERS

Control panel styling and appearance can be changed by adding an auxiliary "Topper" button, as described on page 18.

## MOUNTING

**STANDARD** • Two .140" diameter holes on 1.406" centers. 4-40 extruded and tapped holes are also available.

**PRINTED CIRCUIT BOARD** • Plug directly into suggested hole pattern shown at right.



## TERMINALS

Standard is solder terminal G-20-30 as shown. For PC applications, we suggest terminal G-20-13 and for wire wrap terminations, we recommend terminal G-20-23. You may select other terminals best suited for your application as shown in drawing T-4.



T-4

## TERMINAL PART NUMBERS

| DIMEN. | G-20-13                      | G-20-23                      | G-20-26                      | G-20-27                      | G-20-30                      | G-20-31                      | G-20-33                      | G-20-35                      | G-20-42                      | G-20-48                      | G-20-50                      |
|--------|------------------------------|------------------------------|------------------------------|------------------------------|------------------------------|------------------------------|------------------------------|------------------------------|------------------------------|------------------------------|------------------------------|
| A      | .460 ± .015<br>(11.68 ± .38) | .460 ± .015<br>(11.68 ± .38) | .423 ± .015<br>(10.74 ± .38) | .485 ± .015<br>(12.32 ± .38) | .690 ± .015<br>(17.53 ± .38) | .590 ± .015<br>(14.99 ± .38) | .690 ± .015<br>(17.53 ± .38) | .642 ± .015<br>(16.31 ± .38) | .732 ± .015<br>(18.59 ± .38) | .545 ± .015<br>(13.84 ± .38) | .645 ± .015<br>(16.38 ± .38) |
| B      | .130 ± .010<br>(3.30 ± .25)  | .130 ± .010<br>(3.30 ± .25)  | .093 ± .010<br>(2.36 ± .25)  | .155 ± .020<br>(3.94 ± .51)  | .360 ± .020<br>(9.14 ± .51)  | .260 ± .020<br>(6.60 ± .51)  | .360 ± .020<br>(9.14 ± .51)  | .312 ± .020<br>(7.92 ± .51)  | .402 ± .010<br>(10.21 ± .25) | .215 ± .010<br>(5.46 ± .25)  | .315 ± .020<br>(8.00 ± .51)  |
| C      | .125<br>(3.18)               | .125<br>(3.18)               | .125<br>(3.18)               | .125<br>(3.18)               | .125<br>(3.18)               | .125<br>(3.18)               | .125<br>(3.18)               | .125<br>(3.18)               | .125<br>(3.18)               | .125<br>(3.18)               | .125<br>(3.18)               |
| D      | .060<br>(1.52)               | .064<br>(1.63)               | .060<br>(1.52)               | ---                          | ---                          | ---                          | ---                          | .111<br>(2.82)               | .060<br>(1.52)               | .060<br>(1.52)               | ---                          |
| E      | .170<br>(4.32)               | .390<br>(9.91)               | .210<br>(5.33)               | ---                          | ---                          | ---                          | ---                          | ---                          | .170<br>(4.32)               | .170<br>(4.32)               | ---                          |

# Slide Switch-Standard



## G-378A THREE POLE/DOUBLE THROW (spring return)

### ELECTRICAL RATING

3.0 A AC, 0.5 A DC at 125 V

### LISTING

U.L. & C.S.A.



G-378A  
Actual Size



### MOUNTING

**STANDARD** • Two .140" diameter holes on 1.125" centers. 4-40 extruded and tapped mounting holes also are available.

**PRINTED CIRCUIT BOARD** • Plug directly into board having hole pattern suggested.

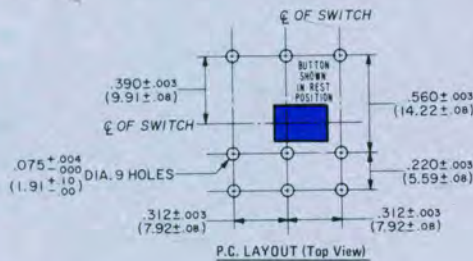

### BUTTONS

| HEIGHT "A"      | PART NO.   | REMARKS  |
|-----------------|------------|----------|
| .344" (8.74mm)  | G-02-191   | Standard |
| .188" (4.78mm)  | G-02-191-1 | Optional |
| .406" (10.31mm) | G-02-191-2 | Optional |
| .500" (12.70mm) | G-02-191-3 | Optional |
| .625" (15.88mm) | G-02-191-4 | Optional |
| .750" (19.05mm) | G-02-191-5 | Optional |

### SOLDER SHIELD (G-29-043)

Vulcanized fiber shield .020" thick that fits over the switch terminals may be shipped assembled or separate, as you specify.

### TOPPERS

Control panel styling and appearance can be changed by adding an auxiliary "Topper" button, as described on page 19.

### TERMINALS

Standard is solder terminal G-20-30 as shown. For PC applications, we suggest G-20-13 and for wire wrap terminations, we recommend terminal G-20-23. You may select other terminals best suited for your application as shown in drawing T-4 on page 25.

### ROCKER SWITCHES

This switch, when combined with bracket and knob assembly, become CW rocker switches. See pages 33-34.

### THREE POLE/THREE POSITION (with detent)



G-368-S  
Actual Size



| TYPE    | ELECTRICAL RATING           | LISTING       |
|---------|-----------------------------|---------------|
| G-368-L | 3.0 A AC, 0.5 A DC at 125 V | U.L. & C.S.A. |
| G-368-S | 3.0 A AC, 0.5 A DC at 125 V | U.L. & C.S.A. |
| G-668-L | 6.0 A AC, 0.5 A DC at 125 V | U.L. & C.S.A. |
| G-668-S | 6.0 A AC, 0.5 A DC at 125 V | U.L. & C.S.A. |



### BUTTONS

| HEIGHT "A"      | PART NO.  | REMARKS  |
|-----------------|-----------|----------|
| .344" (8.74mm)  | G-02-39   | Standard |
| .188" (4.78mm)  | G-02-39-3 | Optional |
| .406" (10.31mm) | G-02-39-4 | Optional |
| .500" (12.70mm) | G-02-39-1 | Optional |
| .625" (15.88mm) | G-02-39-5 | Optional |
| .750" (19.05mm) | G-02-39-2 | Optional |

### MOUNTING

**STANDARD** • Two .140" diameter holes on 1.406" centers. 4-40 extruded and tapped holes also are available.

**PRINTED CIRCUIT BOARD** • Plug directly into board having suggested hole pattern.



### TOPPERS

Control panel styling and appearance can be changed by adding an auxiliary "Topper" button, as described on page 18.

### SOLDER SHIELD (G-29-039)

Vulcanized fiber shield .020" thick that fits over the switch terminals may be shipped assembled or separate, as you specify.

### TERMINALS

Standard is solder terminal G-20-23 as shown. For PC applications, we suggest G-20-13 and for wire wrap terminations, we recommend terminal G-20-23. You may select other terminals best suited for your application as shown in drawing T-4 on page 25.



# Slide Switch-Standard



**THREE POLE/THREE POSITION**  
(Spring return one end to center, detent other end to center)



| TYPE    | ELECTRICAL RATING           | LISTING       |
|---------|-----------------------------|---------------|
| G-337-S | 3.0 A AC, 0.5 A DC at 125 V | U.L. & C.S.A. |
| G-637-S | 6.0 A AC, 0.5 A DC at 125 V | U.L. & C.S.A. |



**G-337-S**  
Actual Size



## BUTTONS

| HEIGHT "A"      | PART NO.   | REMARKS  |
|-----------------|------------|----------|
| .344" (8.74mm)  | G-02-191   | Standard |
| .188" (4.78mm)  | G-02-191-1 | Optional |
| .406" (10.31mm) | G-02-191-2 | Optional |
| .500" (12.70mm) | G-02-191-3 | Optional |
| .625" (15.88mm) | G-02-191-4 | Optional |
| .750" (19.05mm) | G-02-191-5 | Optional |

## SOLDER SHIELD (G-29-045)

Vulcanized fiber shield .020" thick that fits over switch terminals may be shipped assembled or separate, as you specify.

## MOUNTING

**STANDARD** • Two .140" diameter holes on 1.406" centers. 6-32 extruded and tapped holes are also available.

**PRINTED CIRCUIT BOARD** • Plug directly into suggested hole pattern, shown at right.



## TOPPERS

Control panel styling and appearance can be changed by adding an auxiliary "Topper" button, as described on page 18.

## TERMINALS

Standard is solder terminal G-20-31 as shown. For PC applications, we suggest terminal G-20-13 and for wire wrap terminations, we recommend terminal G-20-23. You may select other terminals best suited for your application as shown in drawing T-4.



### TERMINAL PART NUMBERS

| DIMEN. | G-20-13                        | G-20-23                        | G-20-26                        | G-20-27                        | G-20-30                        | G-20-31                        | G-20-33                        | G-20-35                        | G-20-42                        | G-20-48                        | G-20-50                        |
|--------|--------------------------------|--------------------------------|--------------------------------|--------------------------------|--------------------------------|--------------------------------|--------------------------------|--------------------------------|--------------------------------|--------------------------------|--------------------------------|
| A      | .460 ± .015 *<br>(11.68 ± .38) | .460 ± .015 *<br>(11.68 ± .38) | .423 ± .015 *<br>(10.74 ± .38) | .485 ± .015 *<br>(12.32 ± .38) | .690 ± .015 *<br>(17.53 ± .38) | .590 ± .015 *<br>(14.99 ± .38) | .690 ± .015 *<br>(17.53 ± .38) | .642 ± .015 *<br>(16.31 ± .38) | .732 ± .015 *<br>(18.59 ± .38) | .545 ± .015 *<br>(13.84 ± .38) | .645 ± .015 *<br>(16.38 ± .38) |
| B      | .130 ± .010<br>(3.30 ± .25)    | .130 ± .010<br>(3.30 ± .25)    | .093 ± .010<br>(2.36 ± .25)    | .155 ± .020<br>(3.94 ± .51)    | .360 ± .020<br>(9.14 ± .51)    | .260 ± .020<br>(6.60 ± .51)    | .360 ± .020<br>(9.14 ± .51)    | .312 ± .020<br>(7.92 ± .51)    | .402 ± .010<br>(10.21 ± .25)   | .215 ± .010<br>(5.46 ± .25)    | .315 ± .020<br>(8.00 ± .51)    |
| C      | .125<br>(3.18)                 | .125<br>(3.18)                 | .125<br>(3.18)                 | .125<br>(3.18)                 | .125<br>(3.18)                 | .125<br>(3.18)                 | .125<br>(3.18)                 | .125<br>(3.18)                 | .125<br>(3.18)                 | .125<br>(3.18)                 | .125<br>(3.18)                 |
| D      | .060<br>(1.52)                 | .064<br>(1.63)                 | .060<br>(1.52)                 | ---                            | ---                            | ---                            | ---                            | .111<br>(2.82)                 | .060<br>(1.52)                 | .060<br>(1.52)                 | ---                            |
| E      | .170<br>(4.32)                 | .390<br>(9.91)                 | .210<br>(5.33)                 | ---                            | ---                            | ---                            | ---                            | ---                            | .170<br>(4.32)                 | .170<br>(4.32)                 | ---                            |

\*For G-338-L/S, subtract .010 inches.



# Slide Switch-Standard

## FOUR POLE/THREE POSITION (with detent)

| TYPE    | ELECTRICAL RATING                        | LISTING       |
|---------|--|---------------|
| G-360-L | 3.0 A AC, 0.5 A DC at 125 V              | U.L. & C.S.A. |
| G-360-S | 3.0 A AC, 0.5 A DC at 125 V              | U.L. & C.S.A. |
| G-660-L | 6.0 A AC, 0.5 A DC at 125 V (12 A total) | U.L. & C.S.A. |
| G-660-S | 6.0 A AC, 0.5 A DC at 125 V (12 A total) | U.L. & C.S.A. |



G-360-S  
Actual Size



## BUTTONS

| HEIGHT "A"      | PART NO.  | REMARKS  |
|-----------------|-----------|----------|
| .344" (8.74mm)  | G-02-84   | Standard |
| .188" (4.78mm)  | G-02-84-4 | Optional |
| .406" (10.31mm) | G-02-84-5 | Optional |
| .500" (12.70mm) | G-02-84-1 | Optional |
| .625" (15.88mm) | G-02-84-3 | Optional |
| .750" (19.05mm) | G-02-84-2 | Optional |
| .031" (.81mm)   | G-02-109  | Optional |
| .344" (8.74mm)  | G-02-136  | Optional |

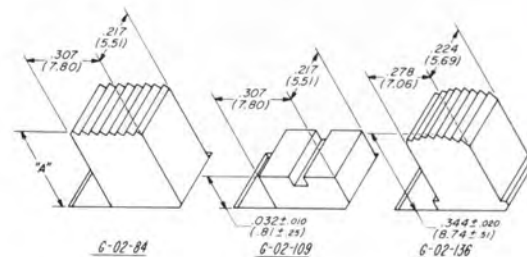

## MOUNTING

**STANDARD** • Two .140" diameter holes on 1.406" centers. 6-32 extruded and tapped holes are also available.  
**PRINTED CIRCUIT BOARD** • Plug directly into board having hole pattern suggested in PC drawing.

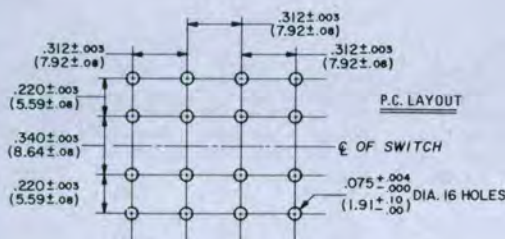

## SOLDER SHIELD (G-29-045)

Vulcanized fiber shield .020" thick that fits over the switch terminals may be shipped assembled or separate, as you specify.

## TOPPERS

Control panel styling and appearance can be changed by adding an auxiliary "Topper" button, as described on page 18.

## TERMINALS

Standard is solder terminal G-20-31 as shown. For PC applications, we suggest terminal G-20-13 and for wire wrap terminations, we recommend terminal G-20-23. You may select other terminals best suited for your application as shown in drawing T-4.

## ROCKER SWITCHES

All of these switches, when combined with bracket and knob assembly, become CW rocker switches. See pages 33.

# Slide Switch-Standard



## DOUBLE POLE/FOUR POSITION (with detent)



| TYPE     | ELECTRICAL RATING            | LISTING       |
|----------|------------------------------|---------------|
| G-338-L  | 3.0 A AC, 0.5 A DC at 125 V  | U.L. & C.S.A. |
| G-338-S  | 3.0 A AC, 0.5 A DC at 125 V  | U.L. & C.S.A. |
| G-638-L  | 6.0 A AC, 0.5 A DC at 125 V  | U.L. & C.S.A. |
| G-638-S  | 6.0 A AC, 0.5 A DC at 125 V  | U.L. & C.S.A. |
| G-838-L  | 8.0 A DC at 12 V             |               |
| G-838-S  | 8.0 A DC at 12 V             |               |
| G-1138-L | 11.0 A AC, 0.5 A DC at 125 V | U.L. & C.S.A. |
| G-1138-S | 11.0 A AC, 0.5 A DC at 125 V | U.L. & C.S.A. |
| G-1338-L | 13.0 A AC, 0.5 A DC at 125 V | U.L. & C.S.A. |
| G-1338-S | 13.0 A AC, 0.5 A DC at 125 V | U.L. & C.S.A. |



G-338-S  
Actual Size



For description of -L and -S versions, see page 27.

### MOUNTING

**STANDARD** • Two .140" diameter holes on 1.718" centers.

**PRINTED CIRCUIT BOARD** • Plug directly into board having suggested hole pattern shown.



### TERMINALS

Standard is solder terminal G-20-30 as shown. For PC applications, we suggest G-20-13 and for wire wrap terminations, we recommend terminal G-20-23. You may select other terminals best suited for your application as shown in drawing T-4 on page 25.

### BUTTONS

| HEIGHT "A"      | PART NO. -S SWITCHES | PART NO. -L SWITCHES | REMARKS  |
|-----------------|----------------------|----------------------|----------|
| .344" (8.74mm)  | G-02-76A1            | G-02-207A1           | Standard |
| .188" (4.78mm)  | G-02-76A5            | G-02-207A5           | Optional |
| .406" (10.31mm) | G-02-76A6            | G-02-207A6           | Optional |
| .500" (12.70mm) | G-02-76A2            | G-02-207A2           | Optional |
| .625" (15.88mm) | G-02-76A4            | G-02-207A4           | Optional |
| .750" (19.05mm) | G-02-76A3            | G-02-207A3           | Optional |
| .344" (8.74mm)  | G-02-74-1            | -                    | Optional |
| .188" (4.78mm)  | G-02-74-5            | -                    | Optional |
| .406" (10.31mm) | G-02-74-6            | -                    | Optional |
| .500" (12.70mm) | G-02-74-2            | -                    | Optional |
| .625" (15.88mm) | G-02-74-4            | -                    | Optional |
| .750" (19.05mm) | G-02-74-3            | -                    | Optional |
| .031" (.79mm)   | G-02-153             | -                    | Optional |
| .125" (3.18mm)  | G-02-153-1           | -                    | Optional |
| .220" (5.59mm)  | G-02-153-2           | -                    | Optional |
| .500" (12.70mm) | G-02-65              | -                    | Optional |

For drawing of buttons for -S switches, see page 42.

### SOLDER SHIELD (G-29-044)

Vulcanized fiber shield .020" thick that fits over the switch terminals may be shipped assembled or separate, as you specify.

### TOPPERS

Control panel styling and applications can be changed by adding an auxiliary "Topper" button, as described on page 18.

### PUSH-PULL

You may find it more convenient to actuate from the front of the switch with the actuating button protruding through your panel.

| DIMENSION "B"    | PART NO.  | REMARKS  |
|------------------|-----------|----------|
| .250" (6.35mm)   | G-02-59-1 | Optional |
| .500" (12.70mm)  | G-02-59-2 | Optional |
| .678" (17.22mm)  | G-02-59-3 | Optional |
| .875" (22.23mm)  | G-02-59-5 | Optional |
| 1.593" (40.46mm) | G-02-59-4 | Optional |





# Standard "Sydneynder" Patented

## GG-351 PC SINGLE POLE/DOUBLE THROW (with detent)

**ELECTRICAL RATING**      **LISTING**  
 3.0 A AC, 0.5 A DC at 125 V      U.L. & C.S.A.



**GG-351 PC**  
**(With staggered terminals)**

Actual Size



### MOUNTING

**STANDARD** • Two .140" diameter holes on 1.125" centers.

**PRINTED CIRCUIT BOARD** • Plug directly into board having suggested hole pattern for terminal arrangement you choose. Standard GG-351 PC has "in-line" terminals that mate with "in-line" PC layout. GG-351 PC with "staggered" terminals is more stable on circuit board prior to soldering and has terminals that mate with "staggered" PC layout.

### BUTTONS

| LENGTH "A"      | PART NO.  | REMARKS  |
|-----------------|-----------|----------|
| .515" (13.08mm) | G-02-58   | Standard |
| .300" (7.62mm)  | G-02-58-4 | Optional |
| .578" (14.68mm) | G-02-58-1 | Optional |
| .750" (19.05mm) | G-02-58-2 | Optional |



### SOLDER SHIELD (G-29-046)

Vulcanized fiber shield .020" thick may be shipped assembled or separate, as you specify. G-29-46 fits over "in-line" switch terminals.

### TERMINALS

Standard is G-20-30. Also available, if specified, are terminals shown in drawing T-4 on page 30.

### ROCKER SWITCHES

This switch, when combined with GR-5, GR-8, or GR-9 bracket and knob assembly, becomes a CW rocker switch. See factory for construction details, page 33.

## GG-355 PC SINGLE POLE/DOUBLE THROW (SPRING RETURN)

**ELECTRICAL RATING**  
3.0 A AC, 0.5 A DC at 125V

**LISTING**  
U.L. & C.S.A.



**GG-355-PC**  
Actual Size



### MOUNTING

Plug directly into printed circuit board cut out to appropriate hole pattern shown. Switch snaps into .064" thick printed circuit board and is completely self supporting until soldered.



### SOLDER SHIELD (G-29-046)

Vulcanized fiber shield .020" thick may be shipped assembled or separate, as you specify. G-29-46 fits over "in-line" switch terminals.



# Standard "Sydwynder"<sup>™</sup>

Patented

## GG-350 PC DOUBLE POLE/DOUBLE THROW (with detent)

**ELECTRICAL RATING**  
3.0 A AC, 0.5 A DC at 125 V

**LISTING**  
U.L. & C.S.A.



GG-350 PC  
Actual Size



### BUTTONS

| LENGTH "A"      | PART NO.   | REMARKS  |
|-----------------|------------|----------|
| .515" (13.08mm) | G-02-41A   | Standard |
| .300" (7.62mm)  | G-02-41A-3 | Optional |
| .578" (14.68mm) | G-02-41A-1 | Optional |
| .750" (19.05mm) | G-02-41A-2 | Optional |

### SOLDER SHIELD (G-29-022)

Vulcanized fiber shield .020" thick may be shipped assembled or separate, as you specify.

### MOUNTING

**STANDARD** • Two .140" diameter holes on 1.125" centers.

**PRINTED CIRCUIT BOARD** • Plug directly into board having suggested hole pattern for terminal arrangement shown at right.



### TERMINALS

Standard is G-20-13. Also available, if specified, are terminals shown in drawing T-4 below.



### ROCKER SWITCHES

This switch, when combined with GR-5, Gr-8, or GR-9 bracket and knob assembly, becomes a CW rocker switch. See page 33.

### TERMINAL PART NUMBERS

| DIMEN. | G-20-13                      | G-20-23                      | G-20-26                      | G-20-27                      | G-20-30                      | G-20-31                      | G-20-33                      | G-20-35                      | G-20-42                      | G-20-48                      | G-20-50                      |
|--------|------------------------------|------------------------------|------------------------------|------------------------------|------------------------------|------------------------------|------------------------------|------------------------------|------------------------------|------------------------------|------------------------------|
| A      | .440 ± .015<br>(11.18 ± .38) | .440 ± .015<br>(11.18 ± .38) | .403 ± .015<br>(10.24 ± .38) | .465 ± .015<br>(11.81 ± .38) | .670 ± .015<br>(17.02 ± .38) | .570 ± .015<br>(14.48 ± .38) | .670 ± .015<br>(17.02 ± .38) | .622 ± .015<br>(15.80 ± .38) | .712 ± .015<br>(18.08 ± .38) | .525 ± .015<br>(13.34 ± .38) | .625 ± .015<br>(15.88 ± .38) |
| B      | .130 ± .010<br>(3.30 ± .25)  | .130 ± .010<br>(3.30 ± .25)  | .093 ± .010<br>(2.36 ± .25)  | .155 ± .020<br>(3.94 ± .51)  | .360 ± .020<br>(9.14 ± .51)  | .260 ± .020<br>(6.60 ± .51)  | .360 ± .020<br>(9.14 ± .51)  | .312 ± .020<br>(7.92 ± .51)  | .402 ± .010<br>(10.21 ± .25) | .215 ± .010<br>(5.46 ± .25)  | .315 ± .020<br>(8.00 ± .51)  |
| C      | .125<br>(3.18)               | .125<br>(3.18)               | .125<br>(3.18)               | .125<br>(3.18)               | .125<br>(3.18)               | .125<br>(3.18)               | .125<br>(3.18)               | .125<br>(3.18)               | .125<br>(3.18)               | .125<br>(3.18)               | .125<br>(3.18)               |
| D      | .060<br>(1.52)               | .064<br>(1.63)               | .060<br>(1.52)               | ---                          | ---                          | ---                          | ---                          | .111<br>(2.82)               | .060<br>(1.52)               | .060<br>(1.52)               | ---                          |
| E      | .170<br>(4.32)               | .390<br>(9.91)               | .210<br>(5.33)               | ---                          | ---                          | ---                          | ---                          | ---                          | .170<br>(4.32)               | .170<br>(4.32)               | ---                          |
| F      | .260 ± .020<br>(6.60 ± .51)  | .260 ± .020<br>(6.60 ± .51)  | .223 ± .020<br>(5.66 ± .51)  | ---                          | ---                          | ---                          | ---                          | ---                          | .532 ± .020<br>(13.51 ± .51) | .345 ± .020<br>(8.76 ± .51)  | ---                          |

**GG-372 SINGLE POLE/DOUBLE THROW (with detent)**



**GG-387 DOUBLE POLE/DOUBLE THROW (with detent)**



**GG-372 PC**  
Actual Size

| TYPE   | ELECTRICAL RATING           | LISTING       |
|--------|-----------------------------|---------------|
| GG-372 | 3.0 A AC, 0.5 A DC at 125 V | U.L. & C.S.A. |
| GG-387 | 3.0 A AC, 0.5 A DC at 125 V | U.L. & C.S.A. |



**BUTTONS**

| LENGTH "A"      | PART NO.   | REMARKS        |
|-----------------|------------|----------------|
| .515" (13.08mm) | G-02-41A   | Std. on GG-387 |
| .515" (13.08mm) | G-02-58    | Std. on GG-372 |
| .300" (7.62mm)  | G-02-41-A3 | Opt. on GG-387 |
| .578" (14.68mm) | G-02-41-A1 | Opt. on GG-387 |
| .750" (19.05mm) | G-02-41-A2 | Opt. on GG-387 |
| .300" (7.62mm)  | G-02-58-4  | Opt. on GG-372 |
| .578" (14.68mm) | G-02-58-1  | Opt. on GG-372 |
| .750" (19.05mm) | G-02-58-2  | Opt. on GG-372 |

**SOLDER SHIELD**

Vulcanized fiber shield .020" thick may be shipped assembled or separate, as you specify. G-29-022 fits GG-387, G-29-046 fits GG-372.

**MOUNTING**

Plug directly into printed circuit board cut out to appropriate hole pattern shown. Switch snaps into .064" thick printed circuit board and is completely self supporting until soldered.





# Standard "Sydwynder" Patented

## G-386 DOUBLE POLE/THREE POSITION (with detent)

**ELECTRICAL RATING**      **LISTING**  
 3.0 A AC, 0.5 A DC at 125 V      U.L.



**G-386 PC**  
Actual Size



### BUTTONS

| LENGTH "A"      | PART NO.  | REMARKS  |
|-----------------|-----------|----------|
| .515" (13.08mm) | G-02-51   | Standard |
| .295" (7.49mm)  | G-02-51-3 | Optional |
| .578" (14.68mm) | G-02-51-1 | Optional |
| .750" (19.05mm) | G-02-51-2 | Optional |

### SOLDER SHIELD (G-29-041)

Vulcanized fiber shield .020" thick that fits over switch terminals may be shipped assembled or separate, as you specify.

### MOUNTING

Plug directly into printed circuit board cut out to hole pattern shown in drawing. Switch snaps onto .064" thick printed circuit board and is completely self-supporting until soldered.





# Rocker Switches



CW rocker switches are designated by "GR" and a number calling out the specific type. A "GR3" rocker superstructure varies from a "GR4", "GR5", "GR8" etc. either in its mounting bracket or actuating knob or both.

In specifying the rocker switch of your choice, add to the rocker superstructure type number, the part number for the switch to which the superstructure is to be added, and omit the prefix to the switch part number. For example, if you wish to add a GR3 rocker superstructure to a GF-342 switch, call out a GR3-342. If you wish to add a GR9 rocker superstructure to a GF-1132 switch, call out a GR9-1132, etc.

## TWO-POSITION TOP-ACTUATED ROCKER SWITCHES

GR3



GR3-326



GR4



GR4-326



## SWITCH DIMENSIONS

|             | "A"                          | "B"                         |
|-------------|------------------------------|-----------------------------|
| Single Pole | .550 ± .015                  | .310 ± .010                 |
| Double Pole | (13.97 ± .38)                | (7.87 ± .25)                |
| Three Poles | .714 ± .015<br>(18.14 ± .38) | .320 ± .010<br>(8.13 ± .25) |
| Four Poles  | 1.000 ± .015<br>(25.4 ± .38) | .330 ± .010<br>(8.38 ± .25) |

## LISTING

U.L. and C.S.A. listings of basic switch apply with rocker superstructure added.

## MOUNTING

Mounting centers and mounting hole sizes are shown in each rocker drawing.

## TERMINALS

Standard is solder terminal G-20-30 as shown. For PC applications, we suggest terminal G-20-13 and for wire wrap terminations, we recommend terminal G-20-23. You may select other terminals best suited for your application as shown in T-4 on page 25.

## SOLDER SHIELD

Vulcanized fiber shield .020" thick that fits over terminals may be shipped assembled or separate, as you specify.

| Switch                   | Shield No. |
|--------------------------|------------|
| Single Pole<br>"In Line" | G-29-046   |
| Double Pole              | G-29-022   |
| Three Poles              | G-29-042   |
| Four Poles               | G-29-043   |

## ROCKER KNOBS

Standard color is black. For other colors contact factory.

## TWO-POSITION TOP-ACTUATED ROCKER SWITCHES

The following switches can be combined with the two-position rocker superstructures shown on pages 33 to 34 to make CW Rocker switches.

| TYPE    | CKT.    | REF. PAGE |
|---------|---------|-----------|
| GF-323  | SPST    | 6-7       |
| GF-623  | SPST    | 6-7       |
| GF-823  | SPST    | 6-7       |
| GF-1123 | SPST    | 6-7       |
| GF-1323 | SPST    | 6-7       |
| GF-1623 | SPST    | 6-7       |
| GF-324  | SPDT    | 6-7       |
| GF-624  | SPDT    | 6-7       |
| GF-824  | SPDT    | 6-7       |
| GF-1124 | SPDT    | 6-7       |
| GF-1324 | SPDT    | 6-7       |
| GF-1624 | SPDT    | 6-7       |
| G-331   | SPST-SR | 10-11     |
| G-631   | SPST-SR | 10-11     |
| G-831   | SPST-SR | 10-11     |
| G-1131  | SPST-SR | 10-11     |
| G-1331  | SPST-SR | 10-11     |
| G-332   | SPDT-SR | 10-11     |
| G-632   | SPDT-SR | 10-11     |
| G-832   | SPDT-SR | 10-11     |
| G-1132  | SPDT-SR | 10-11     |
| G-1332  | SPDT-SR | 10-11     |
| GF-325  | DPST    | 12-13     |
| GF-625  | DPST    | 12-13     |
| GF-825  | DPST    | 12-13     |
| GF-1125 | DPST    | 12-13     |
| GF-1325 | DPST    | 12-13     |
| GF-1625 | DPST    | 12-13     |
| GF-326  | DPDT    | 12-13     |
| GF-626  | DPDT    | 12-13     |
| GF-826  | DPDT    | 12-13     |
| GF-1126 | DPDT    | 12-13     |
| GF-1326 | DPDT    | 12-13     |
| GF-1626 | DPDT    | 12-13     |
| GF-361  | 3PDT    | 15        |
| GF-661  | 3PDT    | 15        |
| GF-861  | 3PDT    | 15        |
| GF-1161 | 3PDT    | 15        |
| GF-1361 | 3PDT    | 15        |
| GF-375A | DPDT-SR | 14        |
| GF-378A | 3PDT-SR | 23        |
| GF-342  | 4PDT    | 16        |
| GF-642  | 4PDT    | 16        |
| GF-842  | 4PDT    | 16        |
| GF-1142 | 4PDT    | 16        |
| GF-1342 | 4PDT    | 16        |



GR5



GR8



GR9



GR13



GR16

# Other **CW INDUSTRIES** Products

---



## **CW ROCKER & POWER SLIDE SWITCHES CATALOG**

From miniature to standard full-sized switches, CW offers a comprehensive line of high-quality, attractively styled and very competitively priced rocker and power slide switches. We offer switches rated to 16A @ 125/250 Vac in circuitries ranging from SPST through DPDT, including center-off, spring-return, and illuminated versions. A variety of color, marking, and termination options are available. Our patented unique contact sliding and rotating action ensures contact cleanliness and extended life.



## **IDC CONNECTOR CATALOG**

CW industries also manufactures a comprehensive product line of insulation displacement connectors designed for mass termination. CW's patented Torq-Tite™ contact provides complete connection reliability between conductor and contact. This is available in Dip Card Edge, PCB, Subminiature "D"s, and socket IDC connectors. Mating headers also are part of this CW product line. Send for Catalog C2110.

## AVAILABLE OPTIONS

**Colors** — CW stores molding powders in many colors. "Toppers" and buttons are available in a variety of colors if your quantity is sufficient.

**Hot Stamping** — Functional or decorative marking of your choice can be imprinted on "Topper" or button surface with CW's "in-house" facilities.

## HOW TO ORDER

Specify CW part number by referencing drawing that shows switch of your choice. If switch you require differs from drawing, specify differences from options available.

Send for more information about CW and its products:

### Switches

**Section III** — Miniature slide switches—up to 8.5 amps, 125 Vac; with actuator travel of .142 for spdt switches

**Section IV** — Microminiature slide switches—up to 0.5 amps, 125 Vac; with actuator travel of .105 for spdt switches

**Section V** — Fully enclosed microminiature slide switches—up to 0.5 amps, 125 Vac; with actuator travel of .090 for spst switches

**Rocker & Power Slide Switches** — Miniature and standard sized; Snap-in mounting; up to 16A @ 125 - 250 VAC; SPST thru DPDT center-off & momentary

Custom designed switches to meet special requirements also available; consult factory.

## CARE IN SWITCH INSTALLATION

CW switches will perform properly if they are installed and used properly. Causes for failure often encountered in the field that are the responsibility of the user are:

1. Removal of factory-applied lubricants from switch contacts and moving parts.
2. Introduction of foreign material into switching mechanism...flux, solder, cleaning materials, potting compounds.
3. Restriction of movement of switch button.
4. Excessive heat often introduced while soldering.
5. Switching loads in excess of rating.

Manufacturing Engineers are cautioned to avoid misusing switches and resultant switch failure.



### IDC Connectors

CW Industries also manufactures a comprehensive product line of insulation displacement connectors designed for mass termination. CW's patented Torq-Tite™ contact provides complete connection reliability between conductor and contact. This is available in Dip, Card Edge, PCB, Subminiature "D"s and socket IDC connectors. Mating headers also are part of this CW product line. Send for Catalog C 2110.

---

**CW INDUSTRIES**

130 James Way, Southampton, PA 18966-3838 • Tel. 215-355-7080 • Fax 215-355-1088 • www.cwind.com



Компания «ЭлектроПласт» предлагает заключение долгосрочных отношений при поставках импортных электронных компонентов на взаимовыгодных условиях!

Наши преимущества:

- Оперативные поставки широкого спектра электронных компонентов отечественного и импортного производства напрямую от производителей и с крупнейших мировых складов;
- Поставка более 17-ти миллионов наименований электронных компонентов;
- Поставка сложных, дефицитных, либо снятых с производства позиций;
- Оперативные сроки поставки под заказ (от 5 рабочих дней);
- Экспресс доставка в любую точку России;
- Техническая поддержка проекта, помощь в подборе аналогов, поставка прототипов;
- Система менеджмента качества сертифицирована по Международному стандарту ISO 9001;
- Лицензия ФСБ на осуществление работ с использованием сведений, составляющих государственную тайну;
- Поставка специализированных компонентов (Xilinx, Altera, Analog Devices, Intersil, Interpoint, Microsemi, Aeroflex, Peregrine, Syfer, Eurofarad, Texas Instrument, Miteq, Cobham, E2V, MA-COM, Hittite, Mini-Circuits, General Dynamics и др.);

Помимо этого, одним из направлений компании «ЭлектроПласт» является направление «Источники питания». Мы предлагаем Вам помощь Конструкторского отдела:

- Подбор оптимального решения, техническое обоснование при выборе компонента;
- Подбор аналогов;
- Консультации по применению компонента;
- Поставка образцов и прототипов;
- Техническая поддержка проекта;
- Защита от снятия компонента с производства.



#### Как с нами связаться

**Телефон:** 8 (812) 309 58 32 (многоканальный)

**Факс:** 8 (812) 320-02-42

**Электронная почта:** [org@eplast1.ru](mailto:org@eplast1.ru)

**Адрес:** 198099, г. Санкт-Петербург, ул. Калинина, дом 2, корпус 4, литера А.