



MICROCHIP

**TC1303 DFN
Adjustable Output
Demo Board
User's Guide**

Note the following details of the code protection feature on Microchip devices:

- Microchip products meet the specification contained in their particular Microchip Data Sheet.
- Microchip believes that its family of products is one of the most secure families of its kind on the market today, when used in the intended manner and under normal conditions.
- There are dishonest and possibly illegal methods used to breach the code protection feature. All of these methods, to our knowledge, require using the Microchip products in a manner outside the operating specifications contained in Microchip's Data Sheets. Most likely, the person doing so is engaged in theft of intellectual property.
- Microchip is willing to work with the customer who is concerned about the integrity of their code.
- Neither Microchip nor any other semiconductor manufacturer can guarantee the security of their code. Code protection does not mean that we are guaranteeing the product as "unbreakable."

Code protection is constantly evolving. We at Microchip are committed to continuously improving the code protection features of our products. Attempts to break Microchip's code protection feature may be a violation of the Digital Millennium Copyright Act. If such acts allow unauthorized access to your software or other copyrighted work, you may have a right to sue for relief under that Act.

Information contained in this publication regarding device applications and the like is provided only for your convenience and may be superseded by updates. It is your responsibility to ensure that your application meets with your specifications. MICROCHIP MAKES NO REPRESENTATIONS OR WARRANTIES OF ANY KIND WHETHER EXPRESS OR IMPLIED, WRITTEN OR ORAL, STATUTORY OR OTHERWISE, RELATED TO THE INFORMATION, INCLUDING BUT NOT LIMITED TO ITS CONDITION, QUALITY, PERFORMANCE, MERCHANTABILITY OR FITNESS FOR PURPOSE. Microchip disclaims all liability arising from this information and its use. Use of Microchip devices in life support and/or safety applications is entirely at the buyer's risk, and the buyer agrees to defend, indemnify and hold harmless Microchip from any and all damages, claims, suits, or expenses resulting from such use. No licenses are conveyed, implicitly or otherwise, under any Microchip intellectual property rights.

Trademarks

The Microchip name and logo, the Microchip logo, Accuron, dsPIC, KEELOQ, microID, MPLAB, PIC, PICmicro, PICSTART, PRO MATE, PowerSmart, rfPIC and SmartShunt are registered trademarks of Microchip Technology Incorporated in the U.S.A. and other countries.

AmpLab, FilterLab, Migratable Memory, MXDEV, MXLAB, SEEVAL, SmartSensor and The Embedded Control Solutions Company are registered trademarks of Microchip Technology Incorporated in the U.S.A.

Analog-for-the-Digital Age, Application Maestro, CodeGuard, dsPICDEM, dsPICDEM.net, dsPICworks, ECAN, ECONOMONITOR, FanSense, FlexROM, fuzzyLAB, In-Circuit Serial Programming, ICSP, ICEPIC, Linear Active Thermistor, Mindi, MiWi, MPASM, MPLIB, MPLINK, PICKIT, PICDEM, PICDEM.net, PICLAB, PICTail, PowerCal, PowerInfo, PowerMate, PowerTool, REAL ICE, rFLAB, rfPICDEM, Select Mode, Smart Serial, SmartTel, Total Endurance, UNI/O, WiperLock and ZENA are trademarks of Microchip Technology Incorporated in the U.S.A. and other countries.

SQTP is a service mark of Microchip Technology Incorporated in the U.S.A.

All other trademarks mentioned herein are property of their respective companies.

© 2006, Microchip Technology Incorporated, Printed in the U.S.A., All Rights Reserved.

 Printed on recycled paper.

QUALITY MANAGEMENT SYSTEM
CERTIFIED BY DNV
== ISO/TS 16949:2002 ==

Microchip received ISO/TS-16949:2002 certification for its worldwide headquarters, design and wafer fabrication facilities in Chandler and Tempe, Arizona, Gresham, Oregon and Mountain View, California. The Company's quality system processes and procedures are for its PICmicro® 8-bit MCUs, KEELOQ® code hopping devices, Serial EEPROMs, microperipherals, nonvolatile memory and analog products. In addition, Microchip's quality system for the design and manufacture of development systems is ISO 9001:2000 certified.



TC1303 DFN ADJUSTABLE OUTPUT DEMO BOARD USER'S GUIDE

Table of Contents

Preface	1
Introduction.....	1
Document Layout	1
Conventions Used in this Guide	2
Recommended Reading.....	2
The Microchip Web Site	3
Customer Support	3
Document Revision History	3
Chapter 1. Product Overview	
1.1 Introduction	5
1.2 What is the TC1303 DFN Adjustable Output Demo Board?	6
1.3 What the TC1303 DFN Adjustable Output Demo Board Kit includes	6
Chapter 2. Installation and Operation	
2.1 Introduction	7
2.2 Features	7
2.3 Getting Started	7
Appendix A. Schematic and Layouts	
A.1 Introduction	11
A.2 Board – Schematic	12
A.3 Board – Top Silk Screen Layer	13
A.4 Board – Top Metal Layer	14
A.5 Board – Bottom Metal Layer	15
Appendix B. Bill Of Materials (BOM)	
Worldwide Sales and Service	18

TC1303 DFN Adjustable Output Demo Board User's Guide

NOTES:



TC1303 DFN ADJUSTABLE OUTPUT DEMO BOARD USER'S GUIDE

Preface

NOTICE TO CUSTOMERS

All documentation becomes dated, and this manual is no exception. Microchip tools and documentation are constantly evolving to meet customer needs, so some actual dialogs and/or tool descriptions may differ from those in this document. Please refer to our web site (www.microchip.com) to obtain the latest documentation available.

Documents are identified with a "DS" number. This number is located on the bottom of each page, in front of the page number. The numbering convention for the DS number is "DSXXXXA", where "XXXX" is the document number and "A" is the revision level of the document.

For the most up-to-date information on development tools, see the MPLAB® IDE on-line help. Select the Help menu, and then Topics to open a list of available on-line help files.

INTRODUCTION

This chapter contains general information that will be useful to know before using the TC1303 DFN Adjustable Output Demo Board . Items discussed in this chapter include:

- Document Layout
- Conventions Used in this Guide
- Recommended Reading
- The Microchip Web Site
- Customer Support
- Document Revision History

DOCUMENT LAYOUT

This document describes how to use the TC1303 DFN Adjustable Output Demo Board . The manual layout is as follows:

- **Chapter 1. "Product Overview"** – Important information about the TC1303 DFN Adjustable Output Demo Board .
- **Chapter 2. "Installation and Operation"** – Includes instructions on how to get started with this user's guide and a description of the user's guide.
- **Appendix A. "Schematic and Layouts"** – Shows the schematic and layout diagrams for the TC1303 DFN Adjustable Output Demo Board .
- **Appendix B. "Bill Of Materials (BOM)"** – Lists the parts used to build the TC1303 DFN Adjustable Output Demo Board .

TC1303 DFN Adjustable Output Demo Board User's Guide

CONVENTIONS USED IN THIS GUIDE

This manual uses the following documentation conventions:

DOCUMENTATION CONVENTIONS

Description	Represents	Examples
Arial font:		
Italic characters	Referenced books	<i>MPLAB[®] IDE User's Guide</i>
	Emphasized text	...is the <i>only</i> compiler...
Initial caps	A window	the Output window
	A dialog	the Settings dialog
	A menu selection	select Enable Programmer
Quotes	A field name in a window or dialog	"Save project before build"
Underlined, italic text with right angle bracket	A menu path	<u><i>File>Save</i></u>
Bold characters	A dialog button	Click OK
	A tab	Click the Power tab
'bnnnn'	A binary number where <i>n</i> is a digit	'b00100, 'b10
Text in angle brackets < >	A key on the keyboard	Press <Enter>, <F1>
Courier font:		
Plain Courier	Sample source code	#define START
	Filenames	autoexec.bat
	File paths	c:\mcc18\h
	Keywords	_asm, _endasm, static
	Command-line options	-Opa+, -Opa-
	Bit values	0, 1
Italic Courier	A variable argument	<i>file.o</i> , where <i>file</i> can be any valid filename
0xnnnn	A hexadecimal number where <i>n</i> is a hexadecimal digit	0xFFFF, 0x007A
Square brackets []	Optional arguments	mcc18 [options] <i>file</i> [options]
Curly brackets and pipe character: { }	Choice of mutually exclusive arguments; an OR selection	errorlevel {0 1}
Ellipses...	Replaces repeated text	var_name [, var_name...]
	Represents code supplied by user	void main (void) { ... }

RECOMMENDED READING

This user's guide describes how to use TC1303 DFN Adjustable Output Demo Board. The following Microchip documents are available and recommended as supplemental reference resources.

TC1303A/TC1303B/TC1303C Data Sheet, "500mA Synchronous Buck Regulator, + 300mA LDO with Power-Good Output" (DS21949)

This data sheet provides detailed information regarding the TC1303 product family.

THE MICROCHIP WEB SITE

Microchip provides online support via our web site at www.microchip.com. This web site is used as a means to make files and information easily available to customers. Accessible by using your favorite Internet browser, the web site contains the following information:

- **Product Support** – Data sheets and errata, application notes and sample programs, design resources, user's guides and hardware support documents, latest software releases and archived software
- **General Technical Support** – Frequently Asked Questions (FAQs), technical support requests, online discussion groups, Microchip consultant program member listing
- **Business of Microchip** – Product selector and ordering guides, latest Microchip press releases, listing of seminars and events, listings of Microchip sales offices, distributors and factory representatives

CUSTOMER SUPPORT

Users of Microchip products can receive assistance through several channels:

- Distributor or Representative
- Local Sales Office
- Field Application Engineer (FAE)
- Technical Support
- Development Systems Information Line

Customers should contact their distributor, representative or field application engineer for support. Local sales offices are also available to help customers. A listing of sales offices and locations is included in the back of this document.

Technical support is available through the web site at: <http://support.microchip.com>

In addition, there is a Development Systems Information Line which lists the latest versions of Microchip's development systems software products. This line also provides information on how customers can receive currently available upgrade kits.

The Development Systems Information Line numbers are:

1-800-755-2345 – United States and most of Canada

1-480-792-7302 – Other International Locations

DOCUMENT REVISION HISTORY

Revision A (July 2006)

- Initial Release of this Document.

TC1303 DFN Adjustable Output Demo Board User's Guide

NOTES:

Chapter 1. Product Overview

1.1 INTRODUCTION

Step-down-converter choices include a variety of linear and switching regulators. The TC1303C Adjustable Output Regulator provides a unique combination of a 500 mA synchronous buck regulator and 300 mA Low-Dropout Regulator (LDO) with a Power-Good (PG) monitor to provide a highly integrated solution of dual supply applications for devices like Cellular Phones, Portable Computers, USB-Powered Devices, Hand Held instruments, etc. The device provides a very cost-effective solution with minimal board space because of the high-frequency operation of the buck converter, which reduces the size requirements of the external inductor and capacitor, the minimal external component requirement by the LDO and the small DFN (dual flat no leads) package size.

The 500 mA synchronous buck regulator switches at a fixed frequency of 2.0 MHz when the load is heavy, providing a low-noise, small-size solution. When the load on the buck output is reduced to light levels, it changes operation to a pulse frequency modulation (PFM) mode to minimize quiescent current drawn from the battery. No intervention is necessary for smooth transition from one mode to another.

The LDO provides a 300 mA auxiliary output that requires a single 1 μ F ceramic output capacitor, minimizing board area and cost. Typical dropout voltage for the LDO output is 137 mV for a 200 mA load.

For the TC1303C, the power-good output is based on the regulation of the buck regulator output, the LDO output or the combination of both. Additional protection features include UVLO, overtemperature and overcurrent protection on both outputs.

This chapter covers the following topics.

- What is the TC1303 DFN Adjustable Output Demo Board?
- What the TC1303 DFN Adjustable Output Demo Board Kit includes.

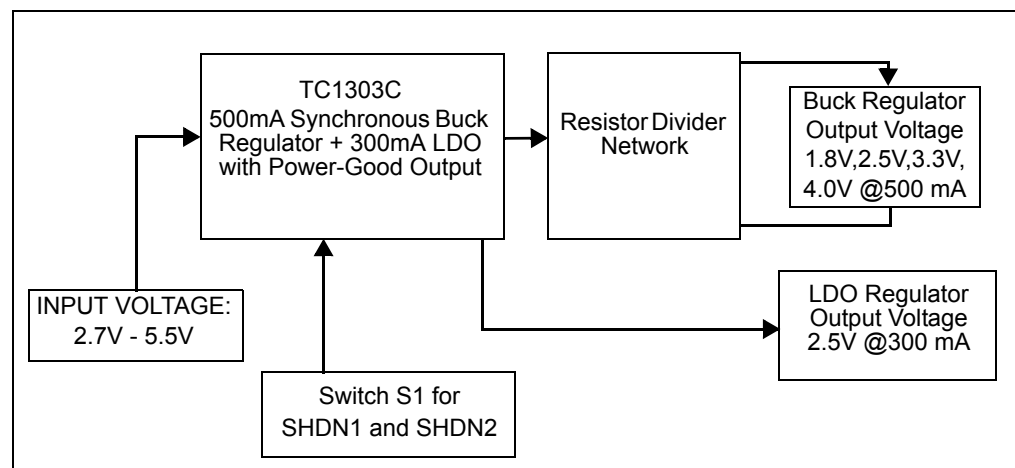

FIGURE 1-1: TC1303 DFN Adjustable Output Demo Board Block Diagram.

TC1303 DFN Adjustable Output Demo Board User's Guide

1.2 WHAT IS THE TC1303 DFN ADJUSTABLE OUTPUT DEMO BOARD?

The TC1303 DFN Adjustable Output demo board demonstrates the use of Microchip's TC1303C device in applications that require dual supply voltage. The demo board is used to evaluate the TC1303C device over the input voltage range, output voltage and current range for both the synchronous buck regulator output and the low dropout linear regulator output.

Test points are provided to monitor the Input voltage, Output voltage, shut down control and power good signal.

1.3 WHAT THE TC1303 DFN ADJUSTABLE OUTPUT DEMO BOARD KIT INCLUDES

This TC1303 DFN Adjustable Output Demo Board kit includes:

- TC1303 DFN Adjustable Output Demo Board (102-00092)
- TC1303 DFN Adjustable Output Demo Board User's Guide (Electronic version on CD-ROM)
- Analog and Interface Products Demonstration Boards CD-ROM (DS21912)

Chapter 2. Installation and Operation

2.1 INTRODUCTION

The TC1303 DFN Adjustable Output Demo Board demonstrates the use of Microchip's TC1303C 500 mA Synchronous Buck Regulator, + 300 mA LDO with Power-Good output device for dual supply voltage applications.

2.2 FEATURES

The TC1303 DFN Adjustable Output Demo Board has the following features.

- Test points for applying Input voltage (2.7V to 5.5V)
- Using Potentiometer, one can set the Buck regulator output voltage from 1.8V to 4.0V
- Fixed LDO regulator output voltage of 2.5V
- Test points for connecting external loads:
 - Buck regulator Output V_{OUT1} = 0 mA to 500 mA
 - LDO regulator Output V_{OUT2} = 0 mA to 300 mA
- Test points for monitoring:
 - Power-Good Output for both V_{OUT1} and V_{OUT2}
 - Shutdown for V_{OUT1} and Shutdown for V_{OUT2}
 - Feedback voltage
- Switch S1 can used to perform the shutdown operation on V_{OUT1} and V_{OUT2}

2.3 GETTING STARTED

The TC1303 DFN Adjustable Output Demo Board is fully assembled and tested for evaluating the TC1303C device. The board requires the use of an external input voltage source of (2.7V to 5.5V) and maximum external load of 500 mA for buck regulator output and 300 mA for LDO regulator output.

2.3.1 Power Input and Output Connection

2.3.1.1 POWERING THE TC1303 DFN ADJUSTABLE OUTPUT DEMO BOARD

For normal operation, it is necessary to pull up the shutdown pins of TC1303C device, the pull up is provided through switch S1 provided on-board.

1. Apply the Input voltage (2.7V to 5.5V for normal operation) to the board test points to TP1 ($+V_{IN}$) and TP2 (P_{GND}) (refer to Figure 2-1).
2. Connect the buck regulator load (0 mA to 500 mA for normal operation) to the board test points TP3 (V_{OUT1}) and TP4 (P_{GND}). The output voltage can be varied from 1.8V to 4.0V using the potentiometer provided on-board. By turning the potentiometer clockwise or counterclockwise, the voltage can be increased or decreased within the 1.8V to 4.0V range.
3. Connect the LDO regulator load (0 mA to 300 mA for normal operation) to test point TP6 (V_{OUT2}) and TP10 (A_{GND}). The LDO regulator provides a fixed output voltage of 2.5V.

TC1303 DFN Adjustable Output Demo Board User's Guide

4. The power-good output signal is available on the test point TP5 (PG).
5. The switch S1, position 1 and position 2 are used to determine the $\overline{\text{SHDN1}}$ and $\overline{\text{SHDN2}}$ modes for the TC1303C device.
6. With switch S1, position 1 pushed to the right, the $\overline{\text{SHDN1}}$ pin is pulled up and the output V_{OUT1} of the TC1303C device is enabled. When switch S1, position 1 is to the left, the TC1303C device is in low quiescent current $\overline{\text{SHDN1}}$ mode and the output V_{OUT1} is disabled. The signal is available on test point TP8.
7. Similarly with switch S1, position 2 pushed to the right, the $\overline{\text{SHDN2}}$ pin is pulled up and the output V_{OUT2} of the TC1303C device is enabled. When switch S1, position 2 is to the left, the TC1303C device is in low quiescent current $\overline{\text{SHDN2}}$ mode and the output V_{OUT2} is disabled. The signal is available on test point TP7.

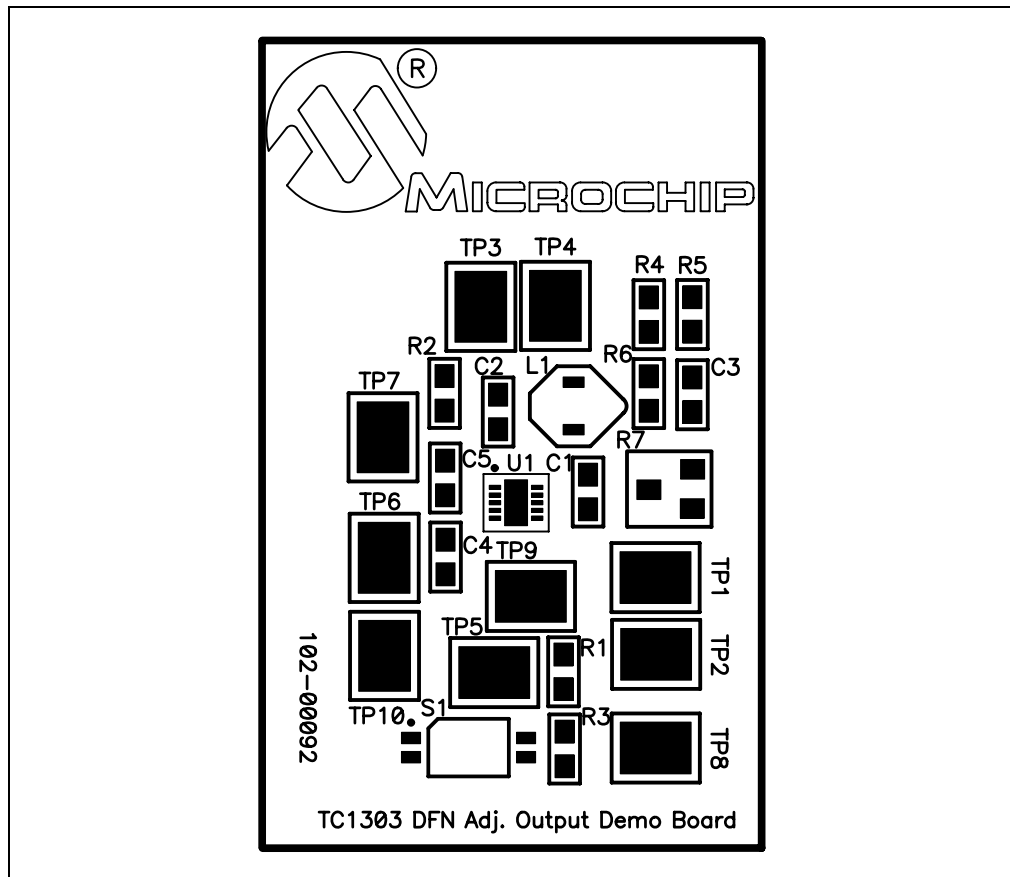

FIGURE 2-1: Setup Configuration Diagram

2.3.1.2 APPLYING LOAD TO TC1303 DFN ADJUSTABLE OUTPUT DEMO BOARD

A variable resistive load can be used to verify the line and load regulation. The load resistance is connected between the points TP3 and TP4 for the buck regulator. To measure the output voltage, connect the common point of multi-meter to TP4 and the positive terminal to TP3. By varying the load one can verify the load regulation by measuring the output voltage over entire load range of 0 mA to 500 mA. Similarly, by varying the line voltage from 2.7V to 5.5V and checking the output voltage, the line regulation can be calculated.

The best way to evaluate the TC1303 DFN Adjustable Output Demo Board is to dig into the circuit. Measure voltages and currents with a DVM and probe the board with an oscilloscope.

Calculating Adjustable Output Voltage

The buck regulator output voltage is adjustable by using two external resistors as a voltage divider. For adjustable-output voltages, it is recommended that the top resistor divider value be 200 kohm. The bottom resistor can be calculated using the following formula.

EQUATION 2-1:

$$R_{BOT} = R_{TOP} \times \left(\frac{V_{FB}}{V_{OUT1} - V_{FB}} \right)$$

Where:

- R_{TOP} = Top resistor (200 kohm)
- V_{OUT1} = Output Voltage
- V_{FB} = 0.8V
- R_{BOT} = Bottom resistor

Example

For setting the output voltage to 3.2V.

EQUATION 2-2:

$$R_{BOT} = 200 \text{ kohm} \times \left(\frac{0.8V}{3.2V - 0.8V} \right)$$

$$= 66.66 \text{ kohm}$$

Where:

- R_{TOP} = 200 kohm
- V_{OUT1} = 3.2V
- V_{FB} = 0.8V

The R_{BOT} resistor can be set using the potentiometer (R7) provided on board so as to provide an output voltage of 3.2V.

TC1303 DFN Adjustable Output Demo Board User's Guide

NOTES:



TC1303 DFN ADJUSTABLE OUTPUT DEMO BOARD USER'S GUIDE

Appendix A. Schematic and Layouts

A.1 INTRODUCTION

This appendix contains the following schematics and layouts for the TC1303 DFN Adjustable Output Demo board:

- Board – Schematic
- Board – Top Silk Screen Layer
- Board – Top Metal Layer
- Board – Bottom Metal Layer

TC1303 DFN Adjustable Output Demo Board User's Guide

A.2 BOARD – SCHEMATIC

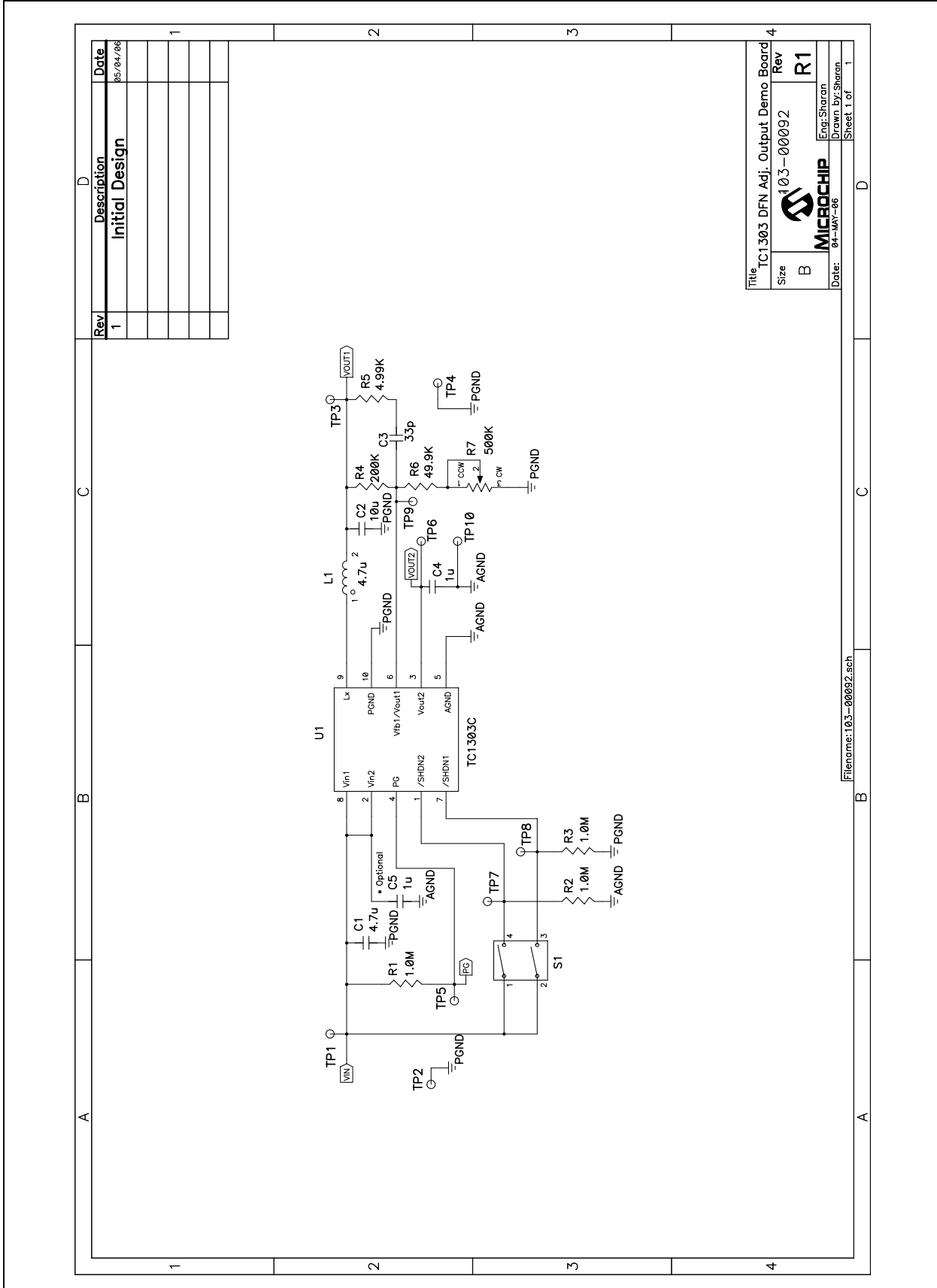

Rev	Description	Date
1	Initial Design	05/04/06

Title: TC1303 DFN Adj. Output Demo Board		Rev	R1
Size	B	Drawn by:	Sharan
Date:	04-MAY-06	Sheet 1 of	1

Filename: 103-00092.sch

A.3 BOARD – TOP SILK SCREEN LAYER

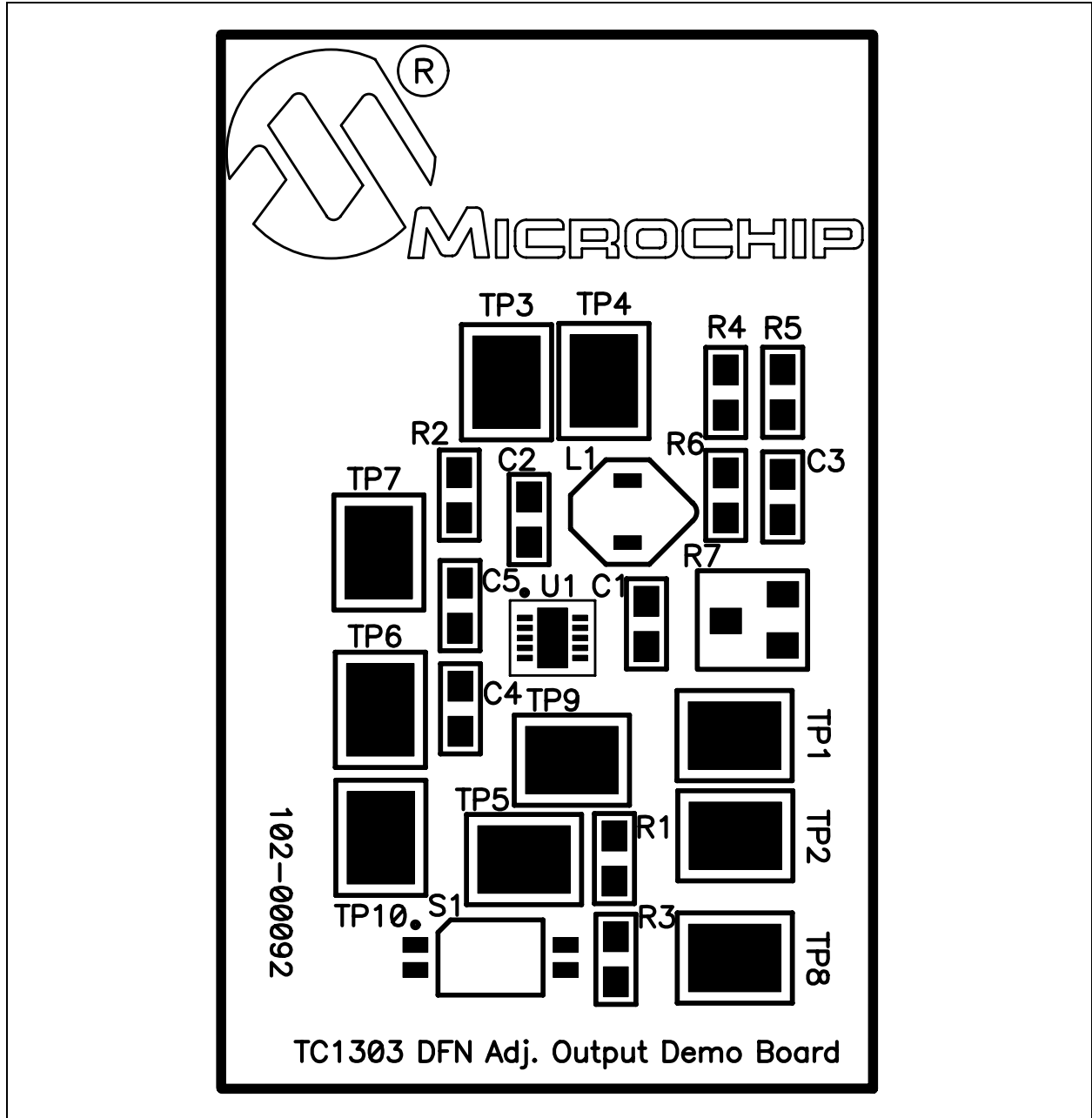

A.4 BOARD – TOP METAL LAYER

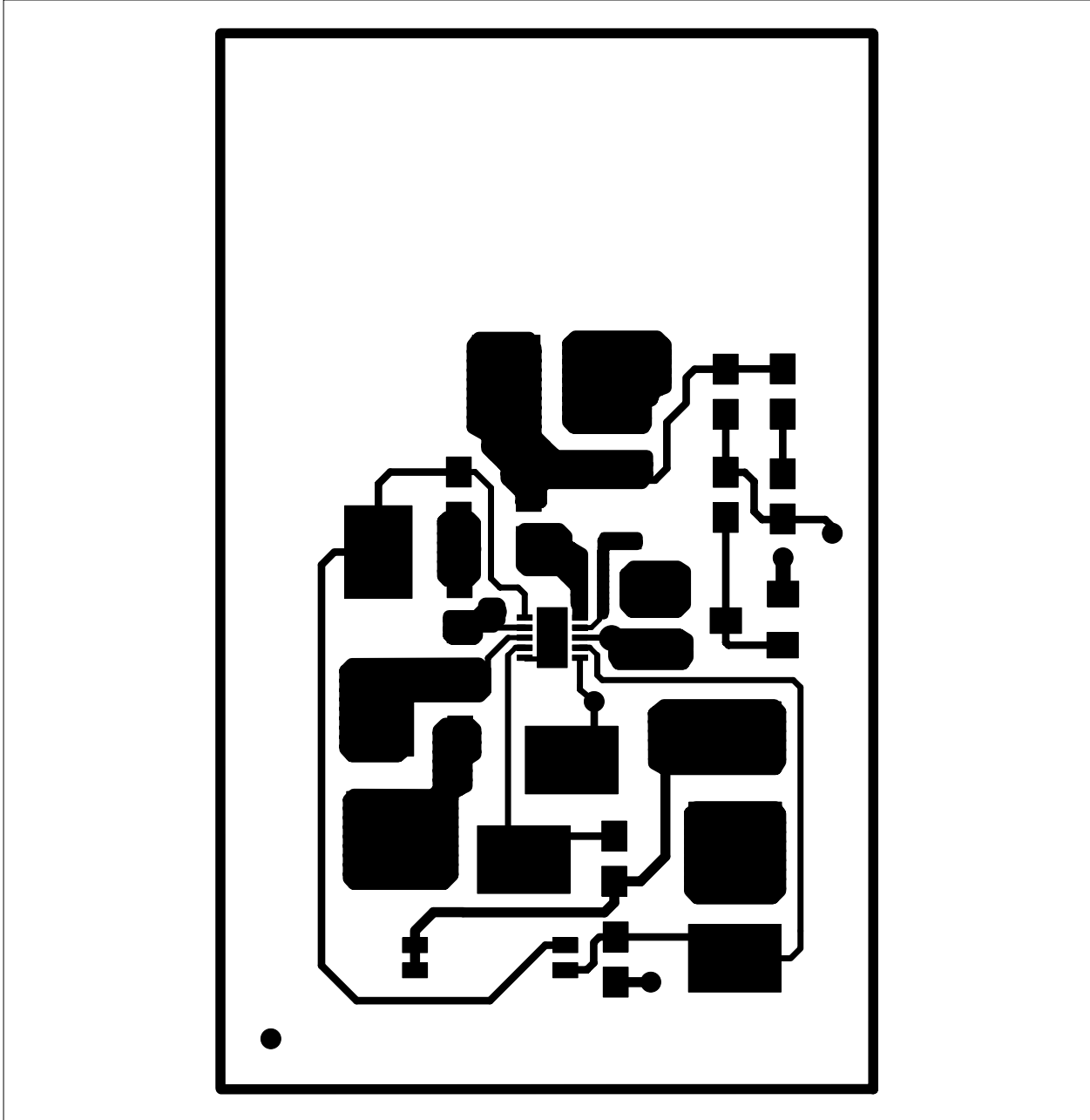

A.5 BOARD – BOTTOM METAL LAYER

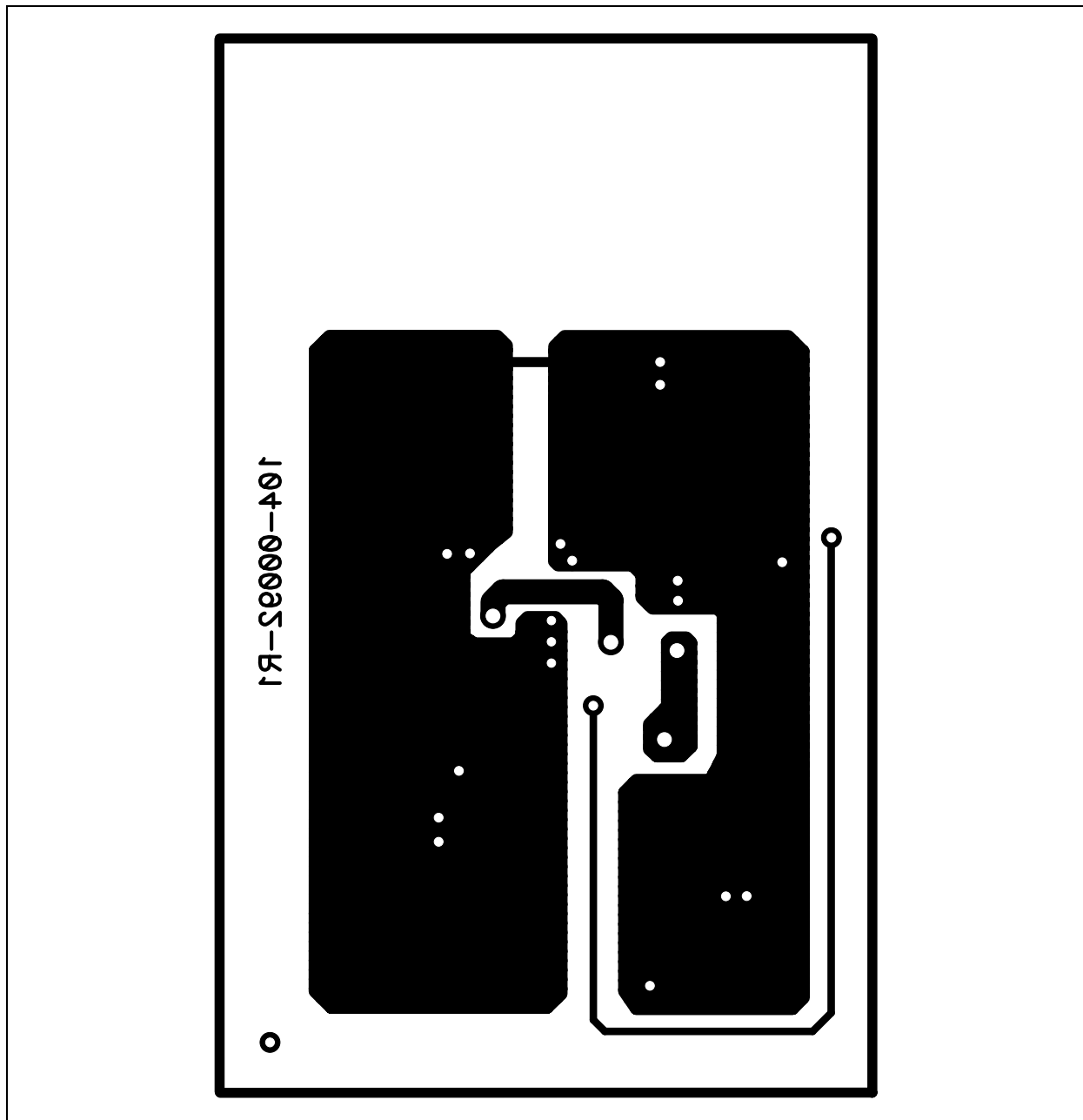

TC1303 DFN Adjustable Output Demo Board User's Guide

NOTES:



TC1303 DFN ADJUSTABLE OUTPUT DEMO BOARD USER'S GUIDE

Appendix B. Bill Of Materials (BOM)

TABLE B-1: BILL OF MATERIALS (BOM)

QTY	Reference	Description	Manufacturer	Part Number
1	C1	Cap Ceramic 4.7 μ F 6.3V X5R 0805	Panasonic [®] - ECG	ECJ-2FB0J475K
1	C2	Cap 10 μ F 6.3V Ceramic X5R 0805	Panasonic - ECG	ECJ-2FB0J106M
1	C3	Cap 33pF 50V Cerm Chip 0805 SMD	Panasonic - ECG	ECJ-2VC1H330J
2	C4,C5	Cap 1 μ F 16V Ceramic 0805 X5R	Panasonic - ECG	ECJ-2FB1C105K
1	L1	Inductor power shield 4.7 μ H	Coiltronics/Div of Cooper/Bussmann	SD3118-4R7-R
3	R1, R2, R3	Res 1.0M Ohm 1/8W 5% 0805 SMD	Panasonic - ECG	ERJ-6GEYJ105V
1	R4	Res 200K Ohm 1/8W 1% 0805 SMD	Panasonic - ECG	ERJ-6ENF2003V
1	R5	Res 4.99K Ohm 1/8W 1% 0805 SMD	Panasonic - ECG	ERJ-6ENF4991V
1	R6	Res 49.9K Ohm 1/8W 1% 0805 SMD	Panasonic - ECG	ERJ-6ENF4992V
1	R7	Trimpot 500K Ohm 11 Trn 5mm Top	Murata Electronics [®] North America	PVG5A504C01R00
1	S1	Switch Dip 2 Pos half pitch SMT	ITT Industries / C&K Div	TDA02H0SK1
10	TP1, TP2, TP3, TP4, TP5, TP6, TP7, TP8, TP9, TP10	PC Test point compact SMT	Keystone [®] Electronics	5016
1	U1	IC PWM 500mA/ LDO 300mA 10 DFN	Microchip Technology Inc	TC1303C-ZI0EMF



MICROCHIP

WORLDWIDE SALES AND SERVICE

AMERICAS

Corporate Office

2355 West Chandler Blvd.
Chandler, AZ 85224-6199
Tel: 480-792-7200
Fax: 480-792-7277
Technical Support:
<http://support.microchip.com>
Web Address:
www.microchip.com

Asia Pacific Office

Suites 3707-14, 37th Floor
Tower 6, The Gateway
Harbour City, Kowloon
Hong Kong
Tel: 852-2401-1200
Fax: 852-2401-3431

Atlanta

Alpharetta, GA
Tel: 770-640-0034
Fax: 770-640-0307

Boston

Westborough, MA
Tel: 774-760-0087
Fax: 774-760-0088

Chicago

Itasca, IL
Tel: 630-285-0071
Fax: 630-285-0075

Dallas

Addison, TX
Tel: 972-818-7423
Fax: 972-818-2924

Detroit

Farmington Hills, MI
Tel: 248-538-2250
Fax: 248-538-2260

Kokomo

Kokomo, IN
Tel: 765-864-8360
Fax: 765-864-8387

Los Angeles

Mission Viejo, CA
Tel: 949-462-9523
Fax: 949-462-9608

San Jose

Mountain View, CA
Tel: 650-215-1444
Fax: 650-961-0286

Toronto

Mississauga, Ontario,
Canada
Tel: 905-673-0699
Fax: 905-673-6509

ASIA/PACIFIC

Australia - Sydney

Tel: 61-2-9868-6733
Fax: 61-2-9868-6755

China - Beijing

Tel: 86-10-8528-2100
Fax: 86-10-8528-2104

China - Chengdu

Tel: 86-28-8676-6200
Fax: 86-28-8676-6599

China - Fuzhou

Tel: 86-591-8750-3506
Fax: 86-591-8750-3521

China - Hong Kong SAR

Tel: 852-2401-1200
Fax: 852-2401-3431

China - Qingdao

Tel: 86-532-8502-7355
Fax: 86-532-8502-7205

China - Shanghai

Tel: 86-21-5407-5533
Fax: 86-21-5407-5066

China - Shenyang

Tel: 86-24-2334-2829
Fax: 86-24-2334-2393

China - Shenzhen

Tel: 86-755-8203-2660
Fax: 86-755-8203-1760

China - Shunde

Tel: 86-757-2839-5507
Fax: 86-757-2839-5571

China - Wuhan

Tel: 86-27-5980-5300
Fax: 86-27-5980-5118

China - Xian

Tel: 86-29-8833-7250
Fax: 86-29-8833-7256

ASIA/PACIFIC

India - Bangalore

Tel: 91-80-4182-8400
Fax: 91-80-4182-8422

India - New Delhi

Tel: 91-11-5160-8631
Fax: 91-11-5160-8632

India - Pune

Tel: 91-20-2566-1512
Fax: 91-20-2566-1513

Japan - Yokohama

Tel: 81-45-471-6166
Fax: 81-45-471-6122

Korea - Gumi

Tel: 82-54-473-4301
Fax: 82-54-473-4302

Korea - Seoul

Tel: 82-2-554-7200
Fax: 82-2-558-5932 or
82-2-558-5934

Malaysia - Penang

Tel: 60-4-646-8870
Fax: 60-4-646-5086

Philippines - Manila

Tel: 63-2-634-9065
Fax: 63-2-634-9069

Singapore

Tel: 65-6334-8870
Fax: 65-6334-8850

Taiwan - Hsin Chu

Tel: 886-3-572-9526
Fax: 886-3-572-6459

Taiwan - Kaohsiung

Tel: 886-7-536-4818
Fax: 886-7-536-4803

Taiwan - Taipei

Tel: 886-2-2500-6610
Fax: 886-2-2508-0102

Thailand - Bangkok

Tel: 66-2-694-1351
Fax: 66-2-694-1350

EUROPE

Austria - Wels

Tel: 43-7242-2244-3910
Fax: 43-7242-2244-393

Denmark - Copenhagen

Tel: 45-4450-2828
Fax: 45-4485-2829

France - Paris

Tel: 33-1-69-53-63-20
Fax: 33-1-69-30-90-79

Germany - Munich

Tel: 49-89-627-144-0
Fax: 49-89-627-144-44

Italy - Milan

Tel: 39-0331-742611
Fax: 39-0331-466781

Netherlands - Drunen

Tel: 31-416-690399
Fax: 31-416-690340

Spain - Madrid

Tel: 34-91-708-08-90
Fax: 34-91-708-08-91

UK - Wokingham

Tel: 44-118-921-5869
Fax: 44-118-921-5820

06/08/06



Компания «ЭлектроПласт» предлагает заключение долгосрочных отношений при поставках импортных электронных компонентов на взаимовыгодных условиях!

Наши преимущества:

- Оперативные поставки широкого спектра электронных компонентов отечественного и импортного производства напрямую от производителей и с крупнейших мировых складов;
- Поставка более 17-ти миллионов наименований электронных компонентов;
- Поставка сложных, дефицитных, либо снятых с производства позиций;
- Оперативные сроки поставки под заказ (от 5 рабочих дней);
- Экспресс доставка в любую точку России;
- Техническая поддержка проекта, помощь в подборе аналогов, поставка прототипов;
- Система менеджмента качества сертифицирована по Международному стандарту ISO 9001;
- Лицензия ФСБ на осуществление работ с использованием сведений, составляющих государственную тайну;
- Поставка специализированных компонентов (Xilinx, Altera, Analog Devices, Intersil, Interpoint, Microsemi, Aeroflex, Peregrine, Syfer, Eurofarad, Texas Instrument, Miteq, Cobham, E2V, MA-COM, Hittite, Mini-Circuits, General Dynamics и др.);

Помимо этого, одним из направлений компании «ЭлектроПласт» является направление «Источники питания». Мы предлагаем Вам помощь Конструкторского отдела:

- Подбор оптимального решения, техническое обоснование при выборе компонента;
- Подбор аналогов;
- Консультации по применению компонента;
- Поставка образцов и прототипов;
- Техническая поддержка проекта;
- Защита от снятия компонента с производства.



Как с нами связаться

Телефон: 8 (812) 309 58 32 (многоканальный)

Факс: 8 (812) 320-02-42

Электронная почта: org@eplast1.ru

Адрес: 198099, г. Санкт-Петербург, ул. Калинина, дом 2, корпус 4, литера А.