

To meet Standard Applications the following 106 ohm, black jacketed cable assemblies are available. For AMPLIMITE .050 Series cable assemblies that meet other impedance requirements or other lengths consult TE.

AMPLIMITE .050 Series Cable Assemblies, Series III



SCSI-2



SCSI-1 to SCSI-2



RS-232 (Alternate)



RS-232 (Alternate) to RS-232



IPI-2 and HIPPI

Application	Assembly	Part Numbers		
		2 Feet	2 Meters	3 Meters
SCSI-2	50 pos. .050 Series Plug to 50 pos. .050 Series Plug	750254-1	5750254-2	750254-3
SCSI-2*	68 pos. .050 Series Plug to 68 pos. .050 Series Plug	—	5750732-2	5750732-4
RS-232 (Alternate)	26 pos. .050 Series Plug to 26 pos. .050 Series Plug	—	750255-2	750255-3

Application	Assembly	Part Numbers		
		5 Meters	15 Meters	25 Meters
IPI-2 and HIPPI	100 pos. .050 Series Plug to 100 pos. .050 Series Plug	749755-2	—	—

*This version has spring latches. Consult TE for availability of jackscrew version.

Note: .050 centerline ribbon cable assemblies are available in single or double ended versions. These assemblies are made using AMPLIMITE .050 Series panel mount connectors, AMPLIMITE .050 Series all-plastic connectors and AMP-LATCH Novo receptacles. Consult TE.

SCSI—Small Computer Systems Interface
 HIPPI—High Performance Parallel Interface
 IPI—Intelligent Peripheral Interface

Note: All part numbers are RoHS compliant.

AMPLIMITE .050 Series Right-Angle Receptacle Headers, Series III

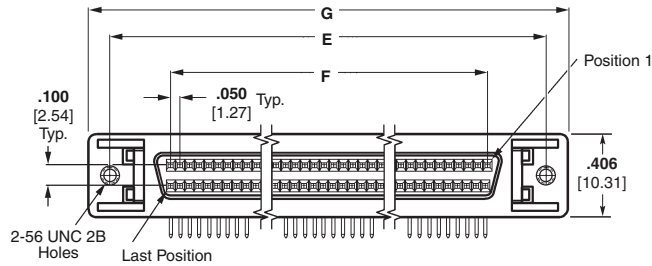
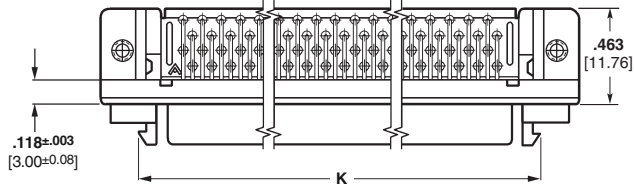

Materials:

- Housing** — Thermoplastic, 94V-0 rated, black. SMT compatible
- Shell** — Steel, plated bright nickel over copper
- Bracket** — Zinc, plated nickel over copper
- Contacts** — Phosphor bronze, duplex plated [.000030] 0.00076 min. gold on mating end; tin on solder end; all under-plated nickel

Technical Documents:

- Product Specifications** — 108-1228
- Application Specifications** — 114-40029

Note: Refer to TE Customer drawings and Application Spec for PCB & panel layouts.

No. of Pos.	Dimensions				Part Numbers						
	E	F	G	K	w/ Rails and Latchblocks		w/o Rails, w/ Latchblocks		w/o Rails, w/o Latchblocks		
					With .100 [2.54] Solder Tails		With .100 [2.54] Solder Tails		With .100 [2.54] Solder Tails		With .120 [3.05] Solder Tails
					Without Boardlocks	With Boardlocks	Without Boardlocks	With Boardlocks	Without Boardlocks	With Boardlocks	With Boardlocks
40	1.580 40.13	.950 24.13	1.815 46.10	1.415 35.94	—	1761028-2	—	5787082-3	—	5787170-4*	—
50	1.830 46.48	1.200 30.48	2.065 52.45	1.665 42.29	5787190-5	1761028-3	5787394-5	5787082-5	—	5787170-5*	5787362-5*
50	1.830 46.48	1.200 30.48	2.065 52.45	1.665 42.29	—	5787266-5*	—	5787395-5*	—	—	—
68	2.280 57.91	1.650 41.91	2.515 63.88	2.115 53.72	5787190-7	1761028-4	5787394-7	5787082-7	5787169-7*	5787170-7*	5787362-7*
100	3.080 78.23	2.450 62.23	3.315 84.20	2.915 74.04	—	1761028-5	—	5787082-9	5787169-9*	5787170-9*	5787362-9*

*Has 4-40 threaded mating holes (2 places), for use with female screwlock Part No. 750644-1.

Note: All part numbers are RoHS compliant.

AMPLIMITE .050 Series Vertical Receptacle Headers With Through-Hole Tails, Series III



Materials:

Housing—Thermoplastic, 94V-0 rated, black. SMT compatible

Shell—Steel, plated bright nickel over copper

Bracket—Zinc, plated nickel over copper

Contacts—Phosphor bronze, duplex plated .000030 [0.00076] min. gold on mating end; tin on solder end; all under-plated nickel

Technical Documents:

Product Specifications—108-1228

Application Specifications—114-40029

Note: Extra pin contact protection is provided by rails, which facilitate a straight-out, unmating motion. A side-to-side rocking motion should not be used to disengage the connector system.

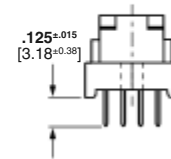

Note: Refer to TE Customer drawings and Application Spec for PCB & panel layouts.



Part Number 749069-5



Part Number 749721-5



Part Number 749070-7

No. of Pos.	Dimensions				Part Numbers		
	L	M	P	R	w/ Rails & Latchblocks	w/ Latchblocks	Plain
20	1.080 27.43	.915 23.24	.450 11.43	1.315 33.40	5749069-1	—	—
26	1.230 31.34	1.065 27.05	.600 15.24	1.465 37.21	5749069-2	—	—
28	1.280 32.51	1.115 28.32	.650 16.51	1.515 38.48	—	5749721-3	—
40	1.580 40.13	1.415 35.94	.950 24.13	1.815 46.10	5749069-4	—	—
50	1.830 46.48	1.665 42.29	1.200 30.48	2.065 52.45	5749069-5	5749721-5	5749070-5
68	2.280 57.91	2.115 53.72	1.650 41.91	2.515 63.88	5749069-7	5749721-7	5749070-7
80	2.580 65.53	2.415 61.34	1.950 49.53	2.815 71.50	5749069-8	—	—
100	3.080 78.23	2.915 74.04	2.450 62.23	3.315 84.20	5749069-9	—	5749070-9

Note: All part numbers are RoHS compliant.

AMPLIMITE .050 Series Vertical Receptacle Headers With Through-Hole Tails, Series III (Continued)

.120 [3.05] Solder Tail Length

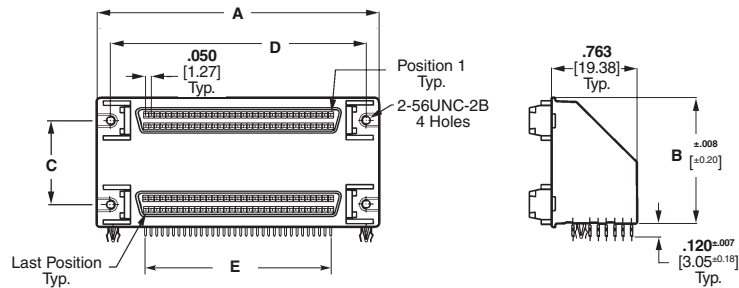

Rails and Latch Blocks

Materials:

Housing—Thermoplastic, 94V-0 rated, black. SMT compatible

Shell—Steel, plated bright nickel over copper

Bracket—Zinc, plated nickel over copper

Contacts—Phosphor bronze, duplex plated .000030 [0.00076] min. gold on mating end; tin on solder end; all under-plated nickel

Related Product Data:

Required Hardware—page 26

Technical Documents:

Product Specifications—108-1228-1

Application Specifications—114-40029

Note: Extra pin contact protection is provided by rails, which facilitate a straight-out unmating motion. A side-to-side rocking motion should not be used to disengage the connector system.



Flat Top Configuration

Note: Refer to TE Customer drawings and Application Spec for PCB & panel layouts.

No. of Pos.	Dimensions					Part No.
	A	B	C	D	E	
50/50	2.085 52.96	.874 22.20	.500 12.70	1.830 46.48	1.200 30.48	5787656-1
68/68	2.535 64.39	1.124 28.55	.750 19.05	2.280 57.91	1.650 41.91	5787678-1
68/68	2.535 64.39	1.124 28.55	.750 19.05	2.280 57.91	1.650 41.91	5787679-1*

*Flat-top configuration.

Note: All part numbers are RoHS compliant.

AMPLIMITE .050 Series Vertical Receptacle Headers, Series III, with ACTION PIN Contacts (.050 x .100 [1.27 x 2.54] Centerlines)

Product Facts

- Recognized under the Component Program of the Underwriters Laboratories, Inc., File No. E28476



- Certified by Canadian Standards Association, File No. 1088108 (LR 7189A-207)



- Produced under a Quality Management System certified to ISO 9001

A copy of the certificate is available upon request



Shielded AMPLIMITE .050 Series headers with ACTION PIN contacts offer a high-density D type interface, and a solderless board-mount interconnection. These vertical mount headers are available in 20, 26, 50, 68 and 100 contact sizes. Choice of configurations includes; headers with rails and latch blocks, with latch blocks only, and without rails and latch blocks.

ACTION PIN contact tails are available in two lengths; .173 [4.39] for pc boards with a nominal thickness of .062 [1.56] to .093 [2.36], and .280 [7.11] for pc boards with a nominal thickness of .125 [3.18] to .200 [5.08].

AMPLIMITE .050 Series headers with ACTION PIN contacts are compatible with SCSI-2, SCSI-3, EIA RS-232, IPI-2 and HIPPI standards.

Principle of the AMPLIMITE .050 Series Compliant ACTION PIN Contact

When an AMPLIMITE .050 Series compliant ACTION PIN contact is inserted into a plated-through-hole, two spring members are compressed, exerting force against the hole for a gas-tight connection. The diameter of the hole is smaller than the diagonal size of the pin.

The beam characteristics of the pin are designed so that a plastic, as well as an elastic, deformation takes place during insertion. The two spring members compress to different degrees to accommodate hole tolerances. The compliant pin also reduces strain on the board. With a rigid pin, the elastic strain energy is stored entirely in the board, leading to damage of the plated-through holes. With the

AMPLIMITE .050 Series compliant ACTION PIN contact, the residual force of the elastic deformation maintains stored energy to produce a gas-tight contact zone between the pin and the plated-through-hole. This ensures long term electrical and mechanical reliability of the interconnection.

Technical Documents:

Product Specification—
108-1228-2

Application Specification—
114-40029

Instruction Sheets—
408 6923—AMP Manual Arbor Frame Assembly
408 9027—AMP Adapter Kit for Greenerd Frame Assemblies 3A and 3B
408 9757—Seating Instructions and Tooling
408 6927—Recommendations for pc board support

AMPLIMITE .050 Series Vertical Receptacle Headers, with ACTION PIN Tails, Series III

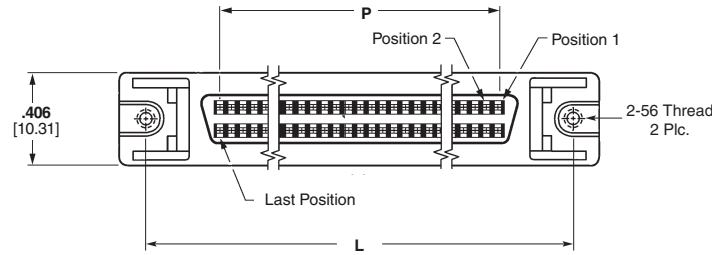

Materials:

- Housings**—Thermoplastic, 94V-0 rated, black, SMT compatible
- Shell**—Carbon steel, plated bright tin over copper
- Bracket**—Zinc, plated nickel over copper
- Contacts**—Phosphor bronze, duplex plated .000030 [0.00076] min. gold on mating end; tin on solder end; all under-plated nickel

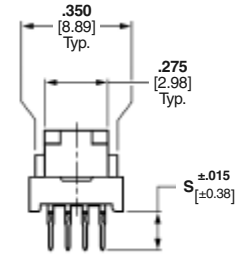
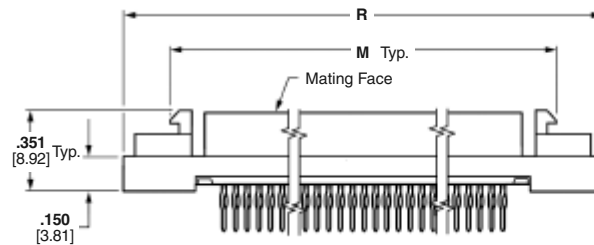

Note: Refer to TE Customer drawings and Application Spec for PCB & panel layouts.

Technical Documents:

- Product Specifications**—108-1228-2
- Application Specifications**—114-40029

Note: Extra pin contact protection is provided by rails, which facilitate a straight-out unmating motion. A side-to-side rocking motion should not be used to disengage the connector system.



Part Number 786554-1

Part Number 786554-7

Part Number 786155-7

No. of Pos.	Dimensions					Part Numbers		
	L	M	P	R	S	w/ Rails & Latchblocks	w/ Latchblocks	Plain
20	1.080 27.43	.915 23.24	.450 11.43	1.315 33.40	.173 4.39	5786554-1	—	—
26	1.230 31.34	1.065 27.05	.600 15.24	1.465 37.21	.173 4.39	5786554-2	—	—
50	1.830 46.48	1.665 42.29	1.200 30.48	2.065 52.45	.173 4.39	5786554-5	5786155-5	5786555-5
					.280 7.11	5786556-5	—	—
68	2.280 57.91	2.115 53.72	1.650 41.91	2.515 63.88	.173 4.39	5786554-7	5786155-7	5786555-7
					.280 7.11	—	786155-7	5786557-7
100	3.080 78.23	2.915 74.04	2.450 62.23	3.315 84.20	.173 4.39	5786554-9	—	5786555-9
120	3.580 90.93	3.415 86.74	2.950 74.93	3.815 96.90	.173 4.39	1-5786554-0	—	—

Note: All part numbers are RoHS compliant.

AMPLIMITE .050 Series Cable Plug Connectors, Series III

Shielded Plugs



Shielded Plug



Wire Lacing Termination Covers

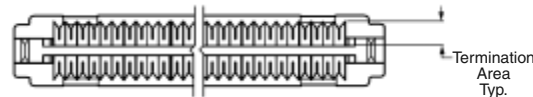
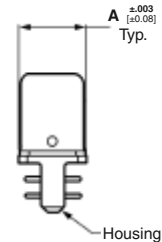
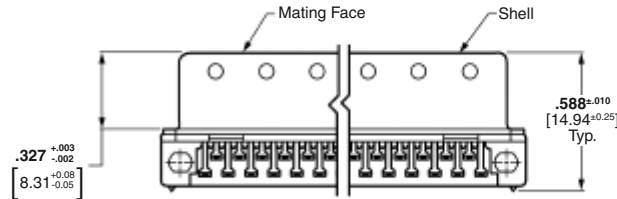
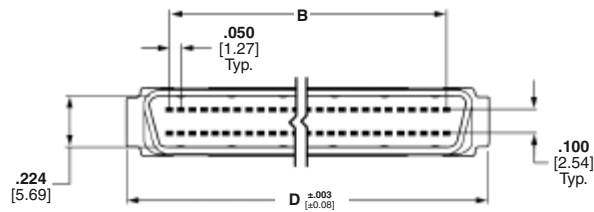

Shielded Plug with Unassembled Wire Lacing Termination Covers

Materials:

Housing and Covers—Thermoplastic, 94V-0 rated, black or gray

Contacts—Phosphor bronze, duplex plated .000030 [0.00076] min. gold on mating end, tin on termination end, all underplated .nickel

Shell—Steel, plated tin-nickel alloy over nickel over min. copper

Recommended wire size—28 AWG [0.08-0.09mm²] or 30 AWG [0.05mm²], solid or 7 strand, with a .029-.036 [0.74-0.89] insulation diameter.

Technical Documents:
Product Specifications—108-1228
Application Specifications—114-40029

Instruction Sheet—408-9427

Connector With Unassembled Wire Lacing Termination Covers

No. of Pos.	Dimensions			Part Numbers	
	A	B	D	.032-.036 [0.81-0.91] Outer Wire Dia. Black	.029-.031 [0.74-0.79] Outer Wire Dia. Gray
26	.293 7.44	.600 15.24	.979 24.87	5750913-2	1-5750913-2
50	.293 7.44	1.200 30.48	1.579 40.11	5750913-5	1-5750913-5
68	.293 7.44	1.650 41.91	2.029 51.54	5750913-7	1-5750913-7
100	.373 9.47	2.450 62.23	2.829 71.86	—	1-5750913-9

- Notes:** 1. Plug connector requires backshell kit for complete assembly. Refer to pages 16-19 for backshell kit part numbers.
 2. For termination, cover closing and wire lacing tooling, see page 14.

Note: All part numbers are RoHS compliant.

AMPLIMITE .050 Series Cable Plug Connectors, Series III (Continued)

Shielded Plugs

(Continued)



Shielded Plug with Unassembled Standard Termination Covers



Shielded Plug with Assembled Standard Termination Covers

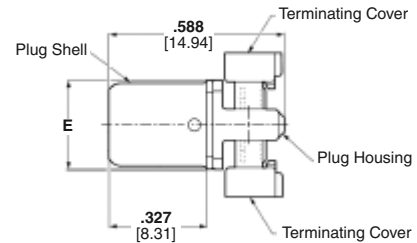
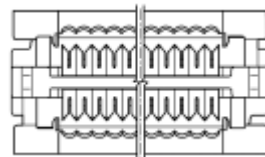
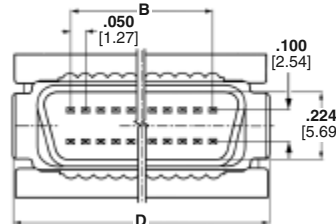
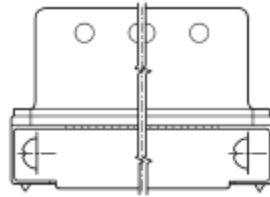

Shielded Plug with Assembled or Unassembled Standard Termination Covers

Materials:

Housing and Covers—

Thermoplastic, 94V-0 rated, black

Contacts—Phosphor bronze, duplex plated .000030 [0.00076] min. gold on mating end, tin on termination end, all underplated nickel

Shell—Steel, plated tin-nickel alloy over nickel over copper

Recommended wire size³ —

28 AWG [0.08-0.09mm²] or 30 AWG [0.05mm²], solid or 7 strand, with a .029-.036 [0.74-0.89] insulation diameter.

Technical Documents:

Product Specifications—108-1228

Application Specifications—114-40029

Instruction Sheet—408-9427

Note: Refer to TE Customer drawings and Application Spec for PCB & panel layouts.

Connectors With Standard Termination Covers

No. of Pos.	Dimensions			Part Numbers	
	B	D	E	w/Rails & Latchblocks	w/Latchblocks
20	.450 11.43	.829 21.06	.293 7.44	5749111-1	5749621-1
26	.600 15.24	.979 24.87	.293 7.44	1-5749111-0	5749621-2
28	.650 16.50	1.029 26.14	.293 7.44	—	5749621-3
40	.950 24.13	1.329 33.76	.293 7.44	5749111-3	5749621-4
50	1.200 30.48	1.579 40.11	.293 7.44	5749111-4	5749621-5
68	1.650 41.91	2.029 51.54	.293 7.44	5749111-6	5749621-7
80	1.950 49.53	2.329 59.16	.373 9.47	5749111-7	5749621-8
100	2.450 62.23	2.829 71.86	.373 9.47	5749111-8	5749621-9
120	2.950 74.93	3.329 84.56	.373 9.47	5749111-9	1-5749621-0

- Notes:**
1. Plug connector requires backshell kit for complete assembly and must use round jacketed cable (discrete or laminated). Refer to pages 16-19 for backshell kit part numbers.
 2. For termination tooling, see pages 28 & 29.
 3. The CHAMPOMATOR 2.5 Automatic Termination Machine will accept diameters as low as .023 [0.58].

Note: All part numbers are RoHS compliant.

AMPLIMITE .050 Series Cable Plug Connectors, Series III (Continued)

AMPLIMITE .050 Series Connectors, Series III

AMPLIMITE .050 Series Connector Application Tooling for Use with Wire Lacing Termination Covers

Manual Arbor Frame Assembly—Part No. 58024-1

Equipped with Cover Lacing Assembly—**Part No. 91293-1** (Includes Seating Bars for 50 and 100 Positions). See Table 3 for Seating Bar Part Numbers.

Extra Lacing Stations available for use with Lacing Assembly—**Part No. 91293-1** Order Lower Tooling Assembly—**Part No. 543481-1**



Arbor Frame, Part No. 58024-1
Equipped with
Cover Lacing Assembly,
Part No. 91293-1



Lower Tooling Assembly
Part No. 543481-1



Miniature Applicator Frame Assembly
Part No. 91295-1
Equipped with Cover Closing Kit
Part No. 543508-1

Note: AMP Manual Miniature Applicator Frame Assembly, Cover Closing Kit, and Staple Insertion Kit each must be ordered separately by part number.



Seatings Bars

Table Number 3

No. of Pos.	Seating Bar Part No.
26	543494-2
40	543494-3
50	543494-1
68	543502-2
100	543502-1

Note: All Tooling must be ordered separately by part number.

Note: All part numbers are RoHS compliant.

AMPLIMITE .050 Series Cable Receptacle Connectors, Series III

AMPLIMITE .050 Series Connectors, Series III

Shielded Receptacles



Shielded Receptacle with Assembled Termination Covers

Materials:

Housing and Covers—

Thermoplastic, 94V-0 rated, black

Contacts—Phosphor bronze, duplex plated .000030 [0.00076] min. gold on mating end, tin on termination end, all underplated nickel

Shell—Steel, plated bright tin over copper

Recommended wire size—

28 AWG [0.08-0.09mm²] or 30 AWG [0.05mm²], solid or 7 strand, with a .029-.036 [0.74-0.89] insulation diameter.

Technical Documents:

Product Specifications—108-1228

Application Specifications—114-40029

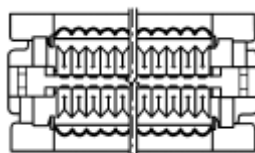
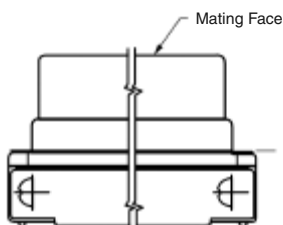
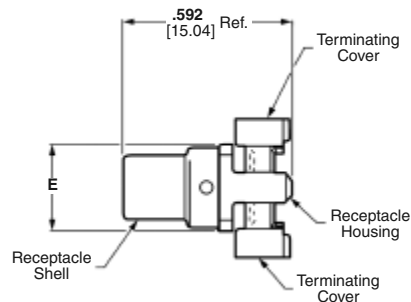
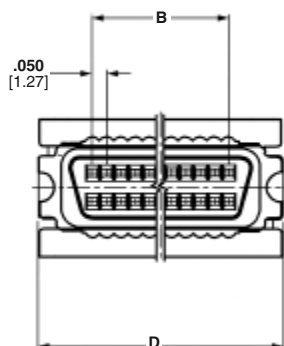

No. of Pos.	Dimensions			Part Numbers	
	B	D	E	Connectors With Standard Termination Covers	
				Assembled Covers	Unassembled Covers
40	.950 24.13	1.329 33.76	.293 7.44	—	—
50	1.200 30.48	1.579 40.11	.293 7.44	5749210-5	5749699-5
68	1.650 41.91	2.029 51.54	.293 7.44	5749210-7	5749699-7
100	2.450 62.23	2.829 71.86	.373 9.47	—	5749699-8

- Notes:**
1. Receptacle connector requires backshell kit for complete assembly. Refer to pages 16-19 for backshell kit part numbers.
 2. For termination, cover closing and wire lacing tooling, see page 14.
 3. For Termination Tooling other than Wire Lacing see pages 28 & 29.

Note: All part numbers are RoHS compliant.

AMPLIMITE .050 Series Shielded Backshell Kits, With Jackscrews, Series III



Straight Exit Male Jackscrews Style A



Straight Exit Male Jackscrews Style B



Straight Exit Female Jackscrews Style A

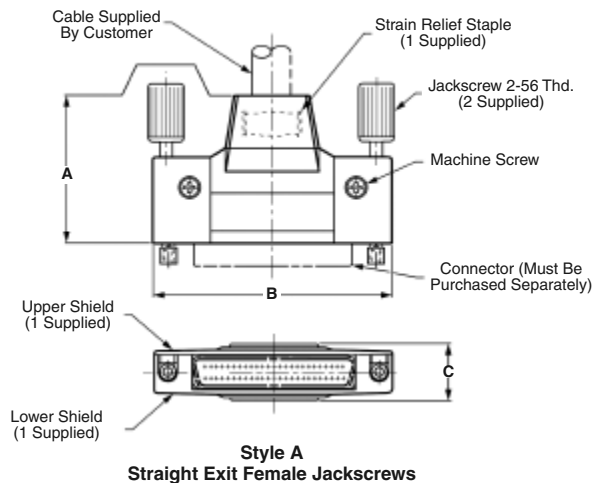
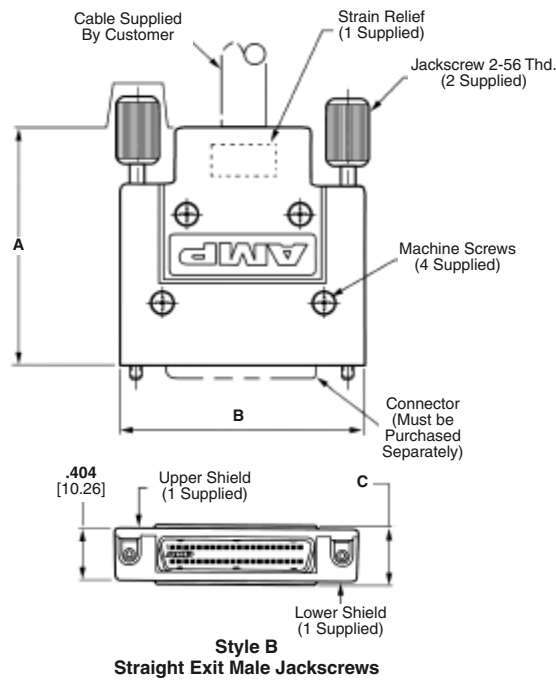
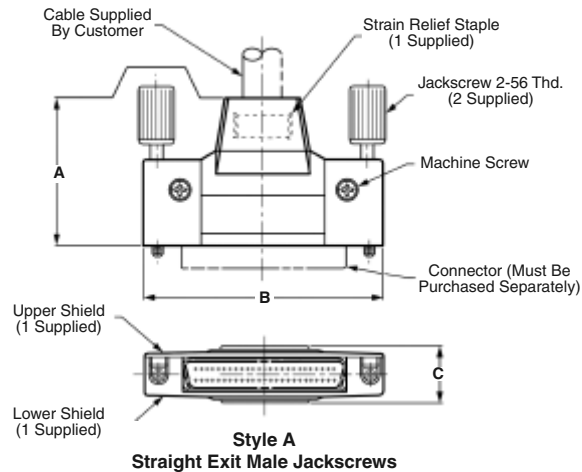

Materials:

Jackscrews—Stainless steel or steel, black electroless nickel plated

Jackscrew Caps—Polyolefin or PVC, black

2-56 Screws—Stainless steel

Backshell—Zinc, plated nickel over copper

Strain Relief Staple—Steel, plated tin over nickel

Technical Documents:

Product Specifications—108-1228

Application Specifications—114-40029

Instruction Sheet—408-9427

AMPLIMITE .050 Series Shielded Backshell Kits, With Jackscrews, Series III (Continued)

No. of Pos.	Style	Dimensions			Pkg.	Max. O.D.	Male with #2-56 Threads	Female with #2-56 Threads
		A	B	C				
40	B	1.822	1.830	.456	Bulk	.450 11.43	5787543-1	5787543-7
		46.25	46.48	11.58	Bulk	.400 10.16	5787543-2	5787543-8
					Bulk	.350 8.89	5787543-3	5787543-9
50	A	1.270	2.085	.480	Individual	.400 10.16	5749080-1	—
		32.26	52.96	12.19	Bulk	.400 10.16	5749080-2	—
68	B	1.887	2.645	.660	Bulk	.550 13.97	5750752-3	—
		47.93	67.18	16.76	Individual	.550 13.97	5786152-3	—
100	A	1.822	2.525	.564	Individual	.500 12.70	5749854-1	—
		46.28	64.14	14.33	Individual	.500 12.70	5749081-1	—
		2.082	3.325	.615	Individual	.500 12.70	5749081-1	—
		52.88	84.46	15.62	Individual	.500 12.70	5749081-1	—
		1.695	3.325	.595	Individual	.500 12.70	5749081-1	—
		43.05	84.46	15.11	Individual	.500 12.70	5749081-1	—

Notes: 1. Each backshell kit includes upper and lower backshells, two male or female jackscrews, one strain relief staple and two or four #2-56 screws. All are packaged unassembled.
 2. For Staple Insertion Tooling see page 29.

Note: All part numbers are RoHS compliant.

AMPLIMITE .050 Series Shielded Backshell Kits, With Spring Latches, Series III



**Style A
Straight Exit
with Latches**



**Style A
Angled Exit
with Latches**



**Style B
Straight Exit
with Latches**

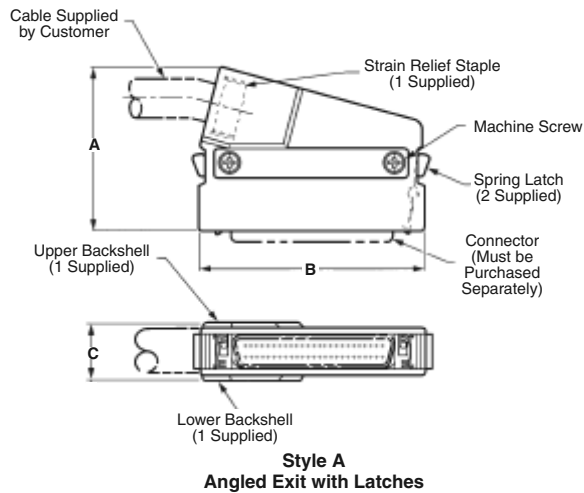
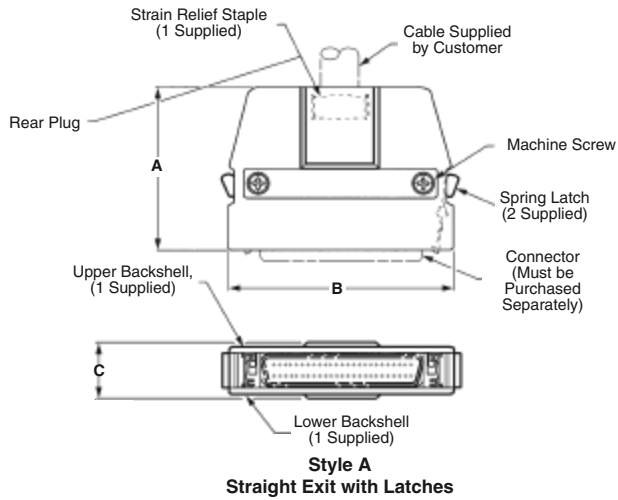

Materials:

Backshell—Zinc, plated nickel over copper

Spring Latch—Stainless steel

2-56 Screws—Stainless steel

Strain Relief Staple—Steel, plated tin over nickel

Technical Documents:

Product Specifications—108-1228

Application Specifications—114-40029

Instruction Sheet—408-9427

Note: Extra pin contact protection is provided by rails on the receptacle, which facilitate a straight-out unmating motion. A side-to-side rocking motion should not be used to disengage the connector system.

AMPLIMITE .050 Series Shielded Backshell Kits, With Spring Latches, Series III (Continued)

No. of Pos.	Style	Dimensions			Pkg.	Max. O.D.	Straight Exit with Latches	Angled Exit with Latches
		A	B	C				
20	A	1.290 32.77	1.215 30.86	.400 10.16	Individual	.270 6.86	5749190-1	5749199-1
26	A	1.290 32.77	1.365 34.67	.400 10.16	Individual	.270 6.86	—	5749609-1
	B	1.290 32.77	1.335 33.91	.400 10.16	Individual	.270 6.86	749608-2	—
40	A	1.290 32.77	1.715 43.56	.400 10.16	Individual	.320 8.13	—	5749201-1
						.320 8.13	5749192-1	—
50	A	1.395 35.43	1.965 49.91	.480 12.19	Individual	.400 10.16	—	5749202-2
					Bulk	.400 10.16	5749202-3	—
					Individual	.355 9.02	5749193-1	—
	B	1.800 45.72	1.965 49.91	.492 12.50	Individual	.400 10.16	5749193-2	—
					Bulk	.480 12.19	5749889-3	—
					Individual	.480 12.18	5749889-4	—
68	A	1.405 35.69	2.415 61.34	.520 13.21	Individual	.400 10.16	—	5749204-1
						.440 11.18	5749195-2	5749204-2
80	A	1.600 40.64	2.715 68.96	.565 14.35	Individual	.420 10.67	—	5749205-1
						.500 12.70	749196-2	—
100	A	1.725 43.82	3.215 81.66	.615 15.62	Individual	.500 12.70	5749197-1	5749206-1
120	A	1.725 43.82	3.715 94.36	.665 16.89	Individual	.550 13.97	5749198-1	5749207-1

Note: All part numbers are RoHS compliant.

AMPLIMITE .050 Series Shielded Enclosure Kits, With Male Jackscrews, Series III

68-Position

Material and Finish:

Backshells—Zinc

Boot—PVC, black

Jackscrews—Stainless steel and PVC, black

Staple—Carbon steel, plated tin over nickel

Screws—Stainless steel, #2-56 threads



Technical Documents:

Product Specifications—108-1228

Application Specifications—
114-40029

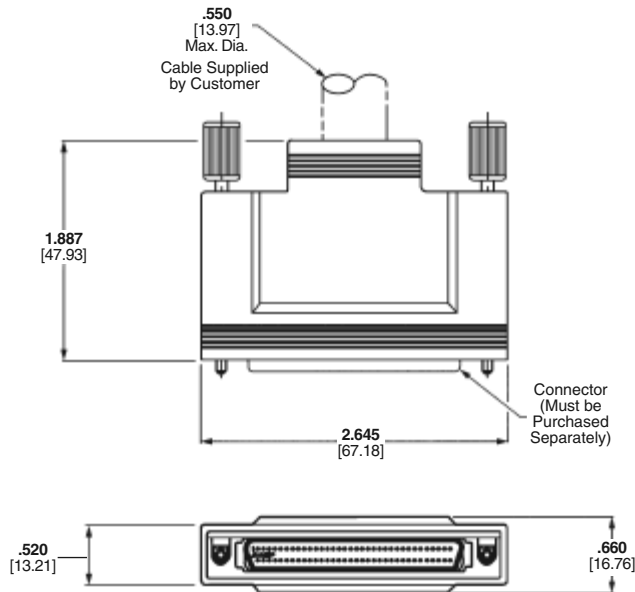

No. of Pos.	Part Number	
	Male 2-56 Jackscrews	Male 4-40 Jackscrews
68	5750752-1	5750752-2

- Notes:**
1. Each enclosure kit contains two backshells, one boot, two jackscrews, one staple and two screws. All are packaged unassembled.
 2. For staple insertion tooling see page 29.
 3. Meets SCSI-3 standards.

Note: All part numbers are RoHS compliant.

AMPLIMITE .050 Series Panel Mount Receptacle Assemblies Without Rails, With Latch Blocks, Series III



Materials:

Housing and Termination Covers—

Thermoplastic, 94V-0 rated, black

Shell—Steel, plated bright nickel over copper

Bracket—Zinc, plated nickel over copper

Contacts—Phosphor bronze, duplex plated .000030 [0.00076] min. gold on mating end, bright tin in termination area, all nickel underplated

Recommended wire size—
 28 AWG [0.08-0.09mm²] or 30 AWG [0.05mm²], solid or 7 strand, with a .029-.036 [0.74-0.89] insulation diameter or .050 [1.27] centerline, 28 AWG [0.08-0.09mm²] stranded, PVC, flat ribbon cable.

Technical Documents:

Product Specifications—108-1228

Application Specifications—114-40029

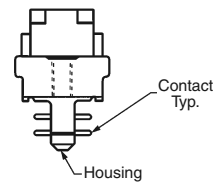
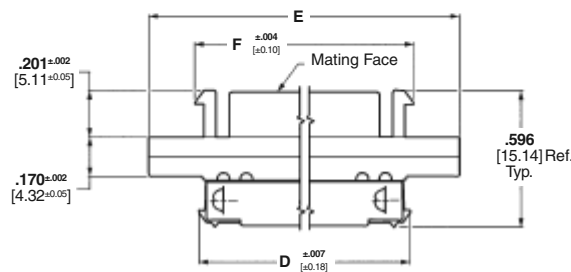
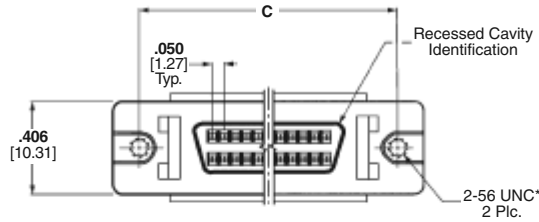

Note: Refer to TE Customer drawings and Application Spec for PCB & panel layouts.

No. of Pos.	Dimensions				Part Numbers		
	C	D	E	F	Connectors With Assembled Standard Termination Covers	Connectors With Unassembled Wire Lacing Termination Covers	
						.032-.036 [0.81-0.91] Outer Wire Dia.	.029-.031 [0.74-0.79] Outer Wire Dia.
50	1.830 46.48	1.629 41.38	2.065 52.45	1.665 42.29	1-749656-1	5-786862-5	6-786862-5
50	1.830 46.48	1.629 41.38	2.065 52.45	1.665 42.29	5-750640-1*	5-786865-5*	—
68	2.280 57.91	2.079 52.81	2.515 63.88	2.115 53.72	1-749656-2	—	—
120	3.580 90.93	3.379 85.83	3.815 96.90	3.415 86.74	6-749656-0	—	—

*Part Numbers 5-750640-1 and 5-786865-5 have 4-40 threaded holes. All others have 2-56 threaded holes.

Note: For termination, cover closing and wire lacing tooling, see page 14.

For termination tooling other than wire lacing see pages 28 & 29.

Note: All part numbers are RoHS compliant.

AMPLIMITE .050 Series Panel Mount Flat Top Receptacle Assemblies Without Rails and Latch Blocks, Series III

AMPLIMITE .050 Series Connectors, Series III

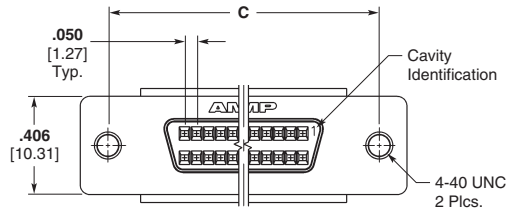

Materials:

Housing and Termination Covers—

Thermoplastic, 94V-0 rated, black

Shell—Steel, plated bright nickel over copper

Bracket—Zinc, plated nickel over copper

Contacts—Phosphor bronze, duplex plated .000030 [0.00076] min. gold on mating end; tin on solder end; all nickel underplated

Recommended wire size—

28 AWG [0.08-0.09mm²] or 30 AWG [0.05mm²], solid or 7 strand, with a .029-.036 [0.74-0.89] insulation diameter or .050 [1.27] centerline, 28 AWG [0.08-0.09mm²] stranded, PVC, flat ribbon cable

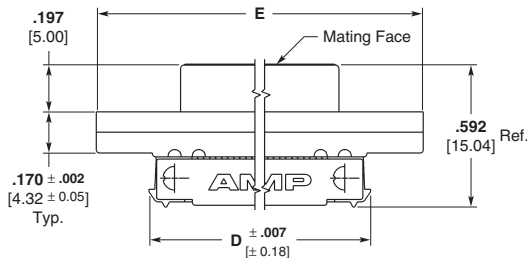

Note: Refer to TE Customer drawings and Application Spec for PCB & panel layouts.

Technical Documents:

Product Specifications—108-1228

Application Specifications—114-40029

Pos. No. of	Dimensions			Part Numbers
	C	D	E	Connectors With Assembled Standard Termination Covers
50	1.830 46.48	1.629 41.38	2.065 52.45	5-749877-5
68	2.280 57.91	2.079 52.81	2.515 63.88	5-749877-7
100	3.080 78.23	2.879 73.13	3.315 84.20	5-749877-9

Note: For termination, cover closing and wire lacing tooling, see page 14. For termination tooling other than wire lacing see pages 28 & 29.

Note: All part numbers are RoHS compliant.

AMPLIMITE .050 Series Panel Mount Plug Assemblies With Rails, Latch Blocks, Series III



Plug

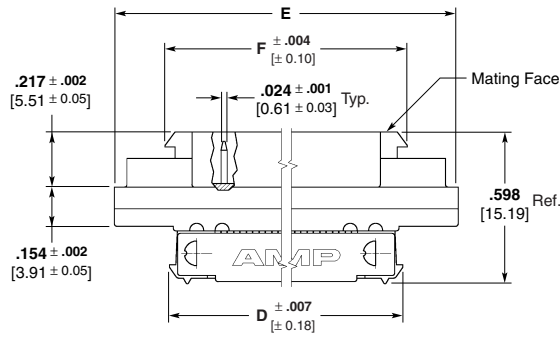
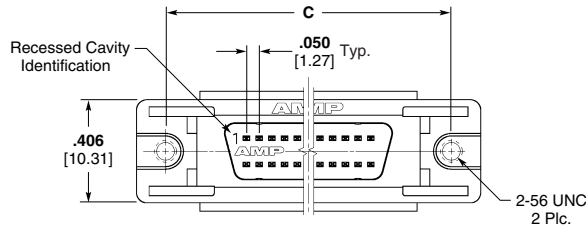

Materials:

Housing and Termination Covers—

Thermoplastic, 94V-0 rated, black

Bracket—Zinc, plated nickel over copper

Contacts—Phosphor bronze, duplex plated .000030 [0.00076] min. gold on mating end, bright tin in termination area, all nickel underplated

Recommended wire size—

28 AWG [0.08-0.09mm²] or 30 AWG [0.05mm²], solid or 7 strand, with a .029-.036 [0.74-0.89] insulation diameter or .050 [1.27] centerline, 28 AWG [0.08-0.09mm²] stranded, PVC, flat ribbon cable.

Technical Documents:

Product Specifications—108-1228

Application Specifications—114-40029

Note: Extra pin contact protection is provided by rails, which facilitate a straight-out, unmating motion. A side-to-side rocking motion should not be used to disengage the connector system.

No. of Positions	Dimensions				Part Numbers
	C	D	E	F	
50	1.830	1.629	2.065	1.665	5-749878-5
	46.48	41.38	52.45	42.29	
68	2.280	2.079	2.515	2.115	5-749878-7
	57.91	52.81	63.88	53.72	
100	3.080	2.879	3.315	2.915	5-749878-9
	78.23	73.13	84.20	74.04	

Note: All part numbers are RoHS compliant.

AMPLIMITE .050 Series Panel Mount Plug Assemblies With Rails, Latch Blocks, Series III (Continued)

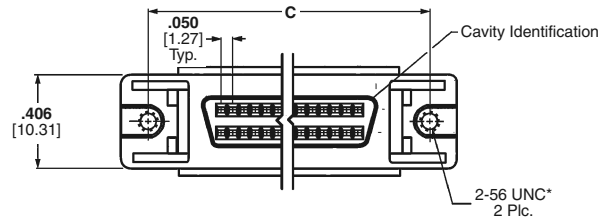

Materials:

Housing and Termination Covers—

Thermoplastic, 94V-0 rated, black

Shell—Steel, plated bright nickel over copper

Bracket—Zinc, plated nickel over copper

Contacts—Phosphor bronze, duplex plated .000030 [0.00076] min. gold on mating end, bright tin in termination area, all nickel underplated

Recommended wire size—

28 AWG [0.08-0.09mm²] or 30 AWG [0.05mm²], solid or 7 strand, with a .029-.036 [0.74-0.89] insulation diameter or .050 [1.27] centerline, 28 AWG [0.08-0.09mm²] stranded, PVC, flat ribbon cable.

Technical Documents:

Product Specifications—108-1228

Application Specifications—114-40029

Note: Extra pin contact protection is provided by rails, which facilitate a straight-out, unmating motion. A side-to-side rocking motion should not be used to disengage the connector system.

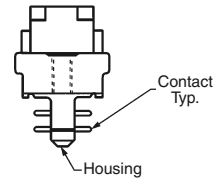
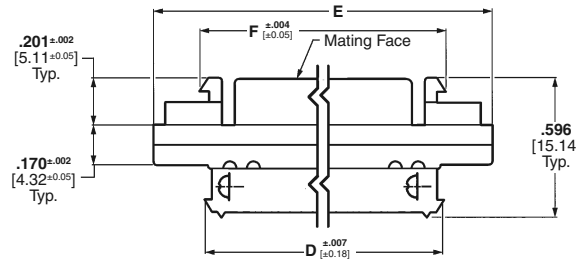

Note: Refer to TE Customer drawings and Application Spec for PCB & panel layouts.

No. of Pos.	Dimensions				Part Numbers
	C	D	E	F	Connectors With Assembled Standard Termination Covers
20	1.080 27.43	.879 22.33	1.315 33.40	.915 23.24	5-749611-2
26	1.230 31.24	1.029 26.14	1.465 37.21	1.065 27.05	5-749611-1
50	1.830 46.48	1.629 41.38	2.065 52.45	1.665 42.29	5-749611-5
50	1.830 46.48	1.629 41.38	2.065 52.45	1.665 42.29	5-750450-1*
100	3.080 78.23	2.879 73.13	3.315 84.20	2.915 74.04	5-749611-9

*Part Number 750450-1 has 4-40 threaded holes. All others have 2-56 threaded holes.

Note: For termination, cover closing and wire lacing tooling, see page 14.
For termination tooling other than wire lacing see pages 28 & 29.

Note: All part numbers are RoHS compliant.

AMPLIMITE .050 Series Plug Assemblies Unshielded for .025 [0.64] Centerline Ribbon Cable, Series III

Plug Assembly



Materials:

Housing and Termination Covers—Thermoplastic, 94V-0 rated, black

Contacts—Phosphor bronze, duplex plated .000030 [0.00076] min. gold on mating end, bright tin on termination end, all over nickel underplating

Recommended wire size—.025 [0.64] centerline, 30 AWG [0.05mm²] solid or 7 strand, PVC, flat ribbon cable.

Note: Cable must be approved by TE Engineering.

Technical Documents for 5786090-7 only:

Product Specifications—108-1359

Application Specifications—114-40049

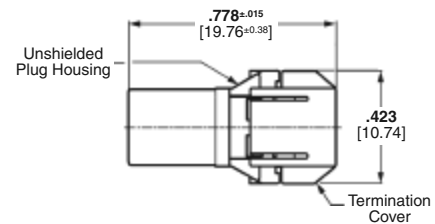
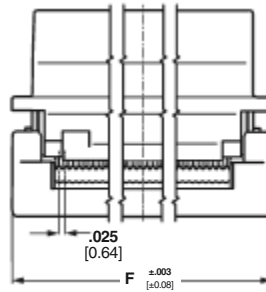
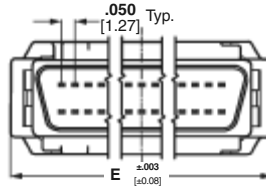

No. of Pos.	Dimensions		Part No.
	E	F	
50	1.578 40.07	1.578 40.07	5390377-5 ¹
68	2.029 51.54	2.023 51.30	5786090-7

Note: Termination Tooling: Manual Arbor Press Part No. 91085-2 or Pneumatic Press Part No. 91112-3, Universal Base Tool Part No. 768338-4, and Connector Specific Kit Part No. 679235-2. Refer to page 29.

¹ Accepts 32 AWG Flat Ribbon Cable. Selection of compatible ribbon cable is the responsibility of the user.

Note: Refer to TE Customer drawings and Application Spec for PCB & panel layouts.

Backshell Kit for 5786090-7 .025 [0.64] Unshielded Plug

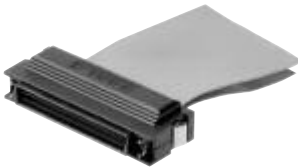

Materials:

Backshell—Thermoplastic, 94V-0 rated, black

Spring Latches—Stainless steel

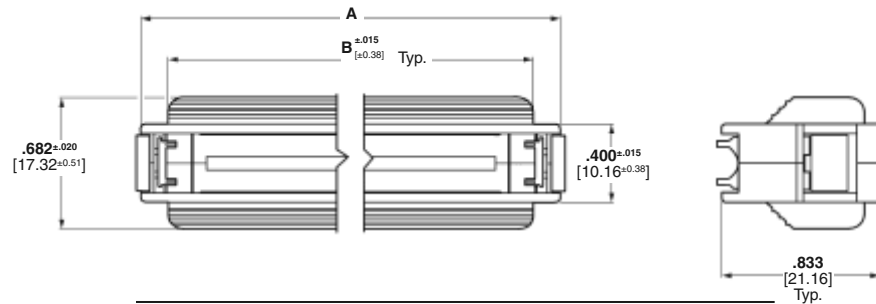

No. of Pos.	Kit Part No.	Dimensions	
		A	B
68	787032-7	2.415 [61.34]	2.125 [53.48]

Strain Relief for 5786090-7 .025 [0.64] Unshielded Plug

68-Position

Part No. 787043-7

Materials:

Thermoplastic, 94V-0 rated, black

Note: Pull tab Part No. 88450-8 can be used with this strain relief. Must be ordered separately.

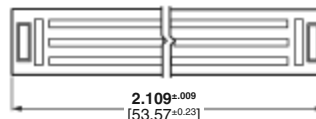
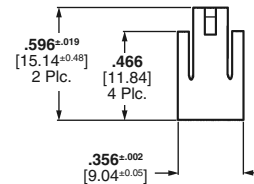

Note: All part numbers are RoHS compliant.

AMPLIMITE .050 Series Hardware and Dust Covers, Series III

Screwlock Kits

Materials:

Stainless steel (female)
Steel, zinc plated black (male)

Related Product Data:

Used with the following connectors:

Right-Angle Receptacle Header—page 7

Vertical Receptacle Header—pages 8-11

Panel Mount Plug and Receptacle Headers—pages 21 & 22

Technical Documents:

Product Specifications—108-1228

Application Specifications—114-40029



Male
Part No. 749086-1
(Includes two screwlocks)



Female
(Includes two screwlocks)

Dim. A	Dim. B	Individual Kits Part No.	Bulk Part No.
.562 14.27	.157 3.99	749087-1	—
.380 9.65	.157 3.99	749087-2 ¹	749087-3
.562 14.27	.165 4.19	749087-4	749087-8

¹ Recommended for right-angle board mount connectors.



Female
(Includes two screwlocks)

Thread Size		Kits Part No.	Bulk Part No.
A	B		
4-40	.110 2.79	750644-1	—
2-56	.090 2.29	786585-2	786585-3

Recommended for pc board mount of panel mount connectors with latches or latches and rails. Permits cable connectors to be spring latch-type or jackscrew-type

Note: All part numbers are RoHS compliant.

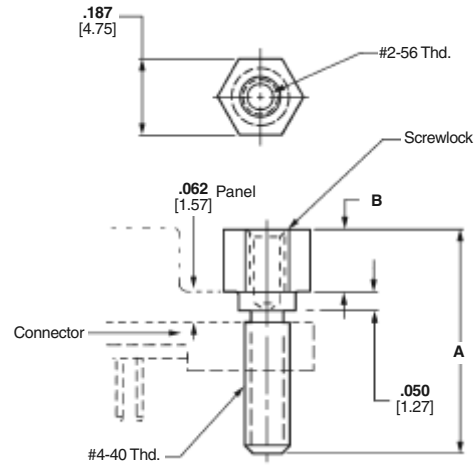

AMPLIMITE .050 Series Performance Specifications and Technical Documents

Performance Specifications for Right-Angle, Vertical and .050 Centerline Cable Products

- Mating Cycles (Durability):** 500 max.
- Current Rating (30°C T-Rise):** 1A max., 50% energized
- Termination Resistance (Mated):** 25 milliohms max.
- Insulation Resistance:** 1000 megohms min.
- Dielectric Withstanding Voltage:** 500 VAC
- Header Processing Temperature:** +220°C max. for 3 minutes
- Temperature Range:** -55°C to 105°C

Performance Specifications for .025 [1.27] Centerline Ribbon Cable Product. Same as above except:

- Current Rating (30°C T-Rise):** 1A max. center four contacts energized (two from top row, two from bottom row)
- Termination Resistance (Mated):** 50 milliohms max.

Product Specifications:

- 108-1228 AMPLIMITE .050 Series Printed Circuit Board Mounted and Cable Applied
- 108-1359 AMPLIMITE .050 Series .025 [0.64] Centerline Connectors
- 108-1228 AMPLIMITE .050 Series Stacked Connectors
- 108-1228-2 AMPLIMITE .050 Series ACTION PIN Connectors
- 108-1228-3 AMPLIMITE .050 Series SBus Connectors

Application Specifications:

- 114-40029 AMPLIMITE .050 Series Printed Circuit Board Mounted and Cable Applied Connectors
- 114-40049 AMPLIMITE .050 Series .025 [0.64] Centerline Connectors

Instruction Sheets:

- 408-6923 AMP Manual Arbor Frame Assembly
- 408-6927 TE Design Recommendations for Printed Circuit Board Support Fixture
- 408-9200 AMP Single Wire Insertion Tool
- 408-9822 Wire Termination Tooling Kit for CHAMPOMATOR 2.5 Machine
- 408-9820 AMP Cover Closing and Staple Inserter Kits
- 408-9663 AMP Mass Insertion Tool
- 408-9750 AMP Cover Lacing Fixture
- 408-9757 AMP Tooling Assembly for ACTION PIN Receptacles
- 408-9817 AMP Manual Miniature Applicator Frame Assembly
- 408-9427 Round-to-Flat Cable Termination
- 408-9875 AMP Universal Base Tool for .025 [0.64] \mathcal{C} Connectors
- 408-9892 AMP Tool Kit for .025 [0.64] \mathcal{C} Connectors

Customer Manuals:

- 409-5839 CHAMPOMATOR 2.5 Machine
- 409-5791 Control Unit for CHAMPOMATOR 2.5 Machine

AMPLIMITE .050 Series Application Tooling, Series III

AMPLIMITE .050 Series Connectors, Series III

Discrete Wire Application Tooling

To meet medium to high volume production of discrete wire terminations, TE offers the following tooling:

The CHAMPOMATOR Model 2.5 Bench Terminating Machine—**Part No. 354786-1**, used in conjunction with Control Module—**Part No. 852423-□**, and Tie Bar—**Part No. 762637-□** (Table No. 1).



Control Module
Part No. 852423-1 120 VAC
852423-2 100 VAC
852423-3 230 VAC

CHAMPOMATOR 2.5 Machine Tool Kit
Part No. 354786-1

Note: The CHAMPOMATOR 2.5 Machine includes plug and receptacle nests, as well as wire setup gauge.

Table Number 1

Connector Size	Tie Bar Part No.
20 Pos.	762637-1
26 Pos.	1-762637-1
28 Pos.	1-762637-2
40 Pos.	762637-3
50 Pos.	762637-4
60 Pos.	762637-5
68 Pos.	762637-6
80 Pos.	762637-7
100 Pos.	762637-9
120 Pos.	1-762637-0

Discrete Wire Application Tooling

For low to medium volume production use the AMP Arbor Frame Assembly—**Part No. 58024-1** equipped with Applicator—**Part No. 91291-1** for .032-.035 [0.81-0.89] Conductor Insulation O.D. and Applicator—**Part No. 91291-2** for .029-.032 [0.74-0.81] Conductor Insulation O.D.

Note: AMP Arbor Frame Assembly and Applicator Kit must be ordered separately.



Arbor Frame
Part No. 58024-1
Equipped with
Applicator Part No. 91291-□

Note: All part numbers are RoHS compliant.

AMPLIMITE .050 Series Application Tooling, Series III (Continued)

**Cover Closing/
Termination Tooling**

**Manual Miniature Applicator
Frame Assembly—
Part No. 91295-1**

This Frame requires Cover Closing Kit—**Part No. 543508-1**

Cable Staple Tooling

To provide cable strain relief use Manual Miniature Applicator Frame Assembly—**Part No. 91295-1**. This Frame requires Staple Insertion Kit—**Part No. 543515-1** to install staples into lower backshells of connector kits and assemblies.



**Staple Insertion Kit
Part No. 543515-1
(For use with Miniature Applicator
Frame Assembly
Part No. 91295-1)**

**Miniature Applicator Frame Assembly
Part No. 91295-1
Equipped with Cover Closing Kit
Part No. 543508-1**

**AMPLIMITE .050 Series
Connector Application
Tooling for Use with Wire
Lacing Terminating Covers**

**Manual Arbor Frame
Assembly—Part No. 58024-1**

Equipped with Cover Lacing Assembly—**Part No. 91293-1 (Includes Seating Bars for 50 and 100 Positions)**. See Table 3 for Seating Bar Part Numbers.

Extra Lacing Stations available for use with Lacing Assembly—**Part No. 91293-1** Order Lower Tooling Assembly—**Part No. 543481-1**



**Arbor Frame, Part No. 58024-1
Equipped with
Cover Lacing Assembly, Part No. 91293-1**

Note: AMP Manual Miniature Applicator Frame Assembly, Cover Closing Kit, and Staple Insertion Kit each must be ordered separately by part number.



Seating Bars

Table Number 3

No. of Pos.	Seating Bar Part No.
26	543494-2
50	543494-1
68	543502-2
100	543502-1

Notes: All Tooling must be ordered separately by part number. Two seating bars required per tool assembly.

**Termination Tooling for
.025 [0.64] Centerline
Ribbon Cable**

Used with Manual Arbor Tool **Part No. 91085-2**, or Pneumatic Arbor Tool **Part No. 91112-3** and Universal Base Tool **Part No. 768338-4**.

No. of Pos.	Plug/Receptacle Upper Tooling Kit
50	679235-2
68	



**Lower Tooling Assembly
Part No. 543481-1**

Note: All part numbers are RoHS compliant.

Shielded AMPLIMITE .050 Series Slimline Connectors

Product Facts

- Compact design, profile for the right-angle header 1.230 x .588 [31.24 x 14.94], vertical header 1.230 x .433 [31.24 x 11.00], right-angle stacked headers 1.230 x .803 [31.24 x 20.40]
- Housings and covers made of UL 94V-0 rated thermoplastic
- Headers are compatible with surface mount reflow solder processes
- Header footprint for right-angle and stacked configurations is .100 x .050 [2.54 x 1.27] staggered centerlines
- Right-angle and stacked headers feature integral boardlocks for positive board retention and grounding
- Stacked headers reduce overall total header volume by 48% and PC board area by 38%
- Stacked headers offer optional contact shield for additional EMI/RFI protection
- Plugs preloaded with insulation displacement contacts (IDC) provide fast, reliable and economical terminations
- Aesthetically designed backshell kits feature easy-to-use finger grip jackscrews to secure mated connectors
- Listed and complies with UL 1863, Communication Circuit Accessories, File No. E81956
- Certified by Canadian Standards Association File No. 1088108 (LR 7189A-207)
- Produced under a Quality Management System certified to ISO 9001

A copy of the certificate is available upon request



Shielded AMPLIMITE .050 Series, Slimline Connectors answer today's industry requirement for higher density in a smaller overall package. The present line consists of 26 position, shielded right-angle, 26 position right-angle stacked PCB receptacle header, and mating 26 position plug connectors. All header, plug and backshell housings are made of UL 94V-0 rated thermoplastic. PCB headers are compatible with surface mount reflow solder processes. Right-angle and stacked PCB headers feature contact footprints on .100 x .050 [2.54 x 1.27] staggered centerlines.

The compact design of the **right-angle header** package measures only 1.230 W x .588 D x .300 H [31.24 W x 14.94 D x 7.62 H] for maximum board real estate conservation. Right-angle PCB headers feature integral

boardlocks for positive board retention and grounding.

Right-angle stacked headers provide 52 contacts in a package only .635 [16.13] high, allowing parallel (board-over-board) board spacing of .800 [20.32]. Centerlines between the top connector and the bottom connector measure .335 [8.51] when compared to .400 [10.16] on the standard .050 Series stacked headers. This results in an over-all reduction of total header volume, in comparison to the standard AMPLIMITE .050 Series header, of 48%, and a comparative reduction in PC board area of 38%.

Stacked header board retention and stabilization is provided by two boardlocks and four grounding posts. In addition, an optional rear contact shield is available for additional EMI/RFI protection.

The mating plug connector consists of a thermoplastic housing, preloaded with insulation displacement contacts (IDC) for fast, reliable terminations that offer greater applied cost savings. TE offers a choice of termination equipment to meet your production requirements.

The backshell hardware kit includes a two-piece, aesthetically designed, thermoplastic cover over an inner and outer shield and two, high strength #2-56 male jackscrews with insulated heads (easy finger grip caps) to secure mated connectors.

The AMPLIMITE .050 Series, Slimline family of connectors offers **keyed coupling**. This feature eliminates the problem of mismatch mating of plug and receptacle, particularly in stacked applications.

Shielded AMPLIMITE .050 Series Slimline Connectors (Continued)

Right-Angle Header, Receptacle



Part No. 750823-1

Material and Finish

Housing—UL 94V-0 rated thermo-plastic, black

Bracket—Zinc, plated tin or tin over copper

Metal-Shell—Carbon steel, plated tin over copper

Boardlocks—Copper alloy, tin plated

Contacts—Phosphor bronze, duplex plated .000030 [0.00076] min. gold on mating end, tin plated on solder end, all over nickel



Notes:

1. Rear panel mounting only.
2. Female screwlocks to be used with connectors mounted to panels having a thickness of .047 [1.19].
3. **See Application Specification 114-40036 for the most up-to-date detailed panel cutout and recommended PC Board hole pattern.**
4. Female screwlocks are not included with receptacles and must be ordered separately. See page 33 for screwlock kit information.

Note: All part numbers are RoHS compliant.

Shielded AMPLIMITE .050 Series Slimline Connectors (Continued)

AMPLIMITE .050 Series Connectors, Series III

Shielded Right-Angle Stacked Header, Receptacle



With Shielding



Without Shielding

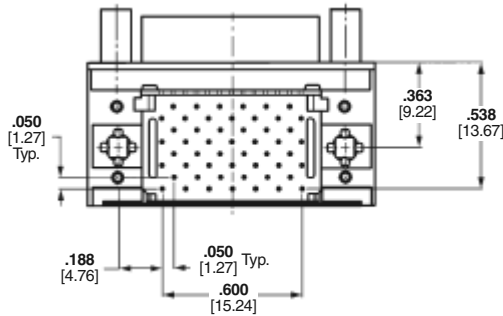
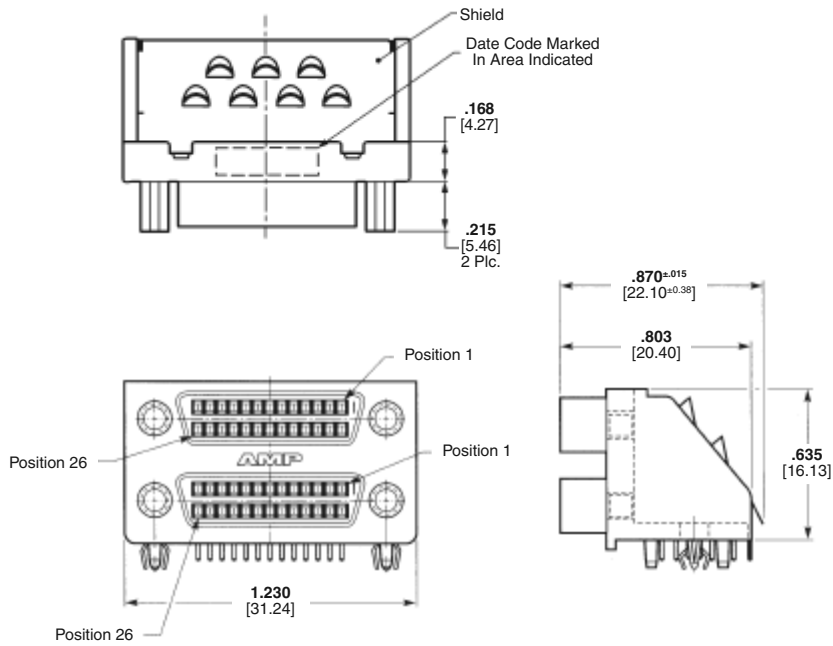

Shielded Header with Rear Contact Shield

Material and Finish:

- Housing**—UL 94V-0 rated thermo-plastic, black
- Bracket**—Zinc, plated tin over copper
- Metal-Shell**—Carbon steel, plated tin over copper
- Boardlocks**—Copper alloy, tin plated
- Contact Shield**—Phosphor bronze, plated tin
- Contacts**—Phosphor bronze, duplex plated .000030 [0.00076] min. on mating end, tin plated on solder end, all over nickel

No. of Positions	Part Numbers			
	Std. Rcpt. without Rear Contact Shield		Rcpt. with Rear Contact Shield ³	
	Keyed ¹	Unkeyed ²	Keyed ¹	Unkeyed ²
26/26	—	5786200-1	5750821-1	5750820-1

¹Lower header unkeyed with 4-40 threaded holes, upper header keyed in keying position 1. See page 33 for keying code.
²Both headers unkeyed with 4-40 threaded holes.
³Receptacle includes a metal contact shield for added RFI protection to the rear of the receptacle assembly.

Note: See Application Specification 114-40036 for the most up-to-date detailed panel cutout and recommended PC Board hole pattern.

Note: All part numbers are RoHS compliant.

Shielded AMPLIMITE .050 Series Slimline Connectors (Continued)

Cable Connector, Plug



Part No. 750833-1

Material and Finish:

Housing and Termination Covers—UL 94V-0 rated thermoplastic, black

Shell—Steel, plated bright tin over copper

Contacts—Phosphor bronze, duplex plated .000030 [0.00076] min. gold on mating end, bright tin on termination end, all underplated nickel

Bracket—Zinc, plated nickel over copper

Recommended Wire Size—28 AWG [0.08 mm²] with max. O.D. .032 [0.813]. PVC or polyolefin insulation.

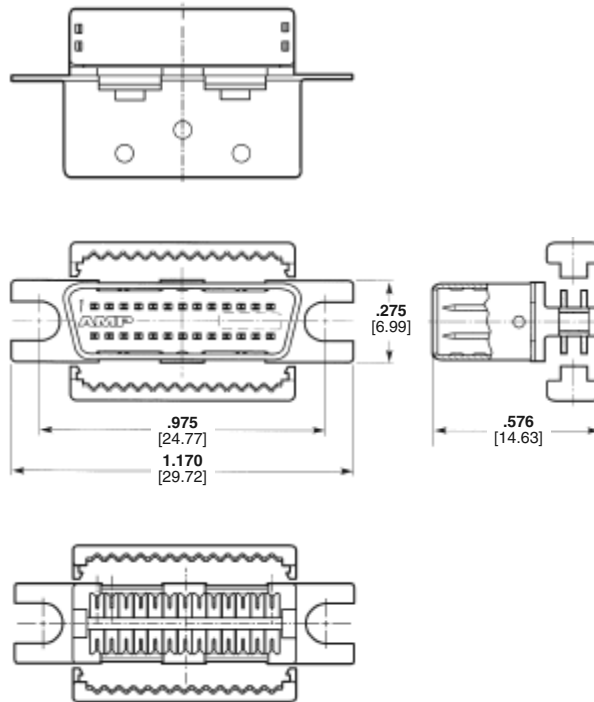

Note: Cable Connectors must be used with Backshell Kits. See page 34.

Keying Code, Receptacle



Keying Code, Plug



Position 1 (Up)

Accessories

Female Screwlock Kit

Material—Stainless Steel

Note: Female screwlocks to be used with connectors mounted to panels having a thickness of .047 [1.19]

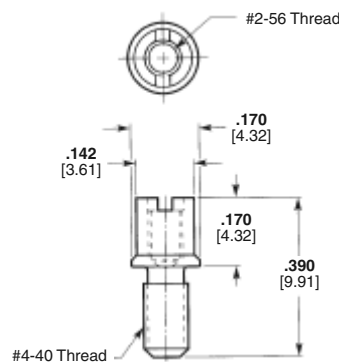

Part No.	Packaging
750831-1	Individually Packed Kit (2 Screwlocks per kit)

*Minimum order is 510 kits.

Note: All part numbers are RoHS compliant.

Shielded AMPLIMITE .050 Series Slimline Connectors (Continued)

AMPLIMITE .050 Series Connectors, Series III

Backshell Kits



Material and Finish:

- Backshells**—Copper-nickel alloy
- Jackscrews**—Steel, plated tin over copper, handles covered with ABS, gray
- Keyed and Unkeyed Inserts**—Zinc, plated tin over copper
- Outside Covers**—ABS, gray



Connector shown for illustration purposes only, must be purchased separately.

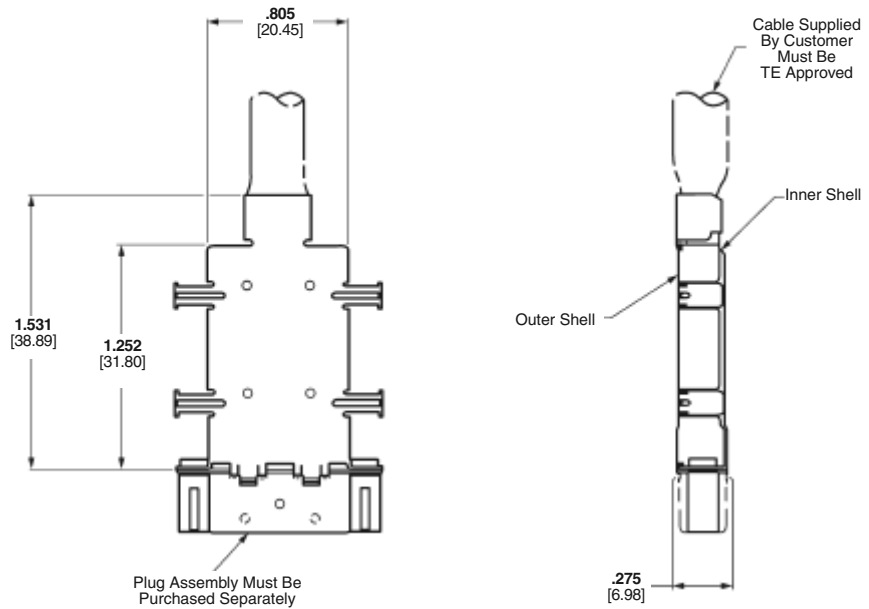

Backshell Kits

Unkeyed Kit Part No.	Cable Dia.	Packaging*
750850-1	.250-.280	Individually Packed Kit
750850-2	6.35-7.11	Bulk Packed Kit
750850-3	.280-.310	Individually Packed Kit

*Bulk packaging—100 kits per box.

Note: All part numbers are RoHS compliant.

Shielded AMPLIMITE .050 Series Slimline Connectors, Application Tooling

Discrete Wire Application Tooling

To meet medium to high volume production of discrete wire terminations, TE offers the following tooling:

The CHAMPOMATOR Model 2.5 Bench Terminating Machine—**Part No. 354786-1**, used in conjunction with Control Module—**Part No. 852423-□**, and Tie Bar—**Part No. 1-762637-3**.

Note: CHAMPOMATOR 2.5 Machine and Control Module must be ordered separately by part number.



Control Module
Part No. 852423-1 120 VAC
852423-2 100 VAC
852423-3 230 VAC

CHAMPOMATOR 2.5 Machine
Part No. 354786-1

26 Position Tie Bar
1-762637-3

Wire Setup Gauge

Wire Insulation Dia.		Part No.
in.	mm	
.026-.028	0.66-0.71	763382-3
.029-.031	0.74-0.79	763382-4
.032-.035	0.81-0.89	763382-5

Discrete Wire Application Tooling

For low to medium volume production use the TE Arbor Tool—**Part No. 58024-1** equipped with Applicator—**Part No. 91291-1** and Special Locator—**Part No. 543506-1**.



Arbor Tool
Part No. 58024-1
Equipped with
Applicator Part No.
91291-1



Miniature Applicator Frame Assembly
Part No. 91295-1
Equipped with Cover Closing Kit
Part No. 543508-1



Staple Insertion Kit
Part No. 543515-1
(For use with Miniature Applicator
Frame Assembly
Part No. 91295-1)

Cable-to-Shell Staple Tooling (For discrete wire jacketed cable only)

To meet medium to high volume production use TE Pneumatic Crimper—**Part No. 312522-3** equipped with Die Holder Assembly—**Part No. 58449-1** and Die—**Part No. 90437-1** to crimp outer backshells onto inner backshells of connector kits and assemblies.

For low volume use Manual Arbor Tool—**Part No. 91085-2**, equipped with Backshell Crimper Assembly Tool—**Part No. 856684-1**.



Pneumatic Bench Tool
No. 312522-3
(Requires Die Set Holder
No. 58449-1)

Backshell Tooling and Cover Tooling

To assemble backshell into plastic housing use Manual Miniature Applicator Frame Assembly—**Part No. 91295-1** equipped with **Part No. 543521-1**. To assemble upper cover on lower cover use **Part No. 91295-1** equipped with **Part No. 543522-1**.

For tooling information call
Tooling Assistance Center
1-800-722-1111.

Note: All part numbers are RoHS compliant.

Shielded AMPLIMITE .050 Series Contact Arrangements, Performance Specifications, Technical Documents—Slimline Connectors

Contact Arrangements

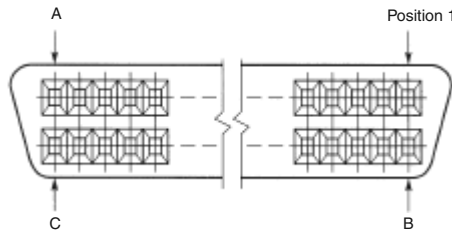

Note: Mating face of receptacle is shown, plug is mirror image.

No. of Pos.	Position No.		
	A	B	C
26	13	14	26

Performance Specifications

Mating Cycles (Durability): 500 max.
Current Rating (30°C T-Rise): 1A max., 50% loading
Termination Resistance (Mated): 25 milliohms max.
Insulation Resistance: 1000 megohms min.
Dielectric Withstanding Voltage: 500 VAC
Header Processing Temperature: +220°C max. for 3 minutes
Temperature Range: -55°C to +105°C

Technical Documents

Product Specifications describe technical performance characteristics and verification tests. They are intended for the Design, Component and Quality Engineer.

108-1366 Shielded AMPLIMITE .050 Series, Slimline Connectors

Application Specifications describe requirements for using the product in its intended application and/or termination information. They are intended for the Packaging and Design Engineer and the Setup person.

114-40036 Shielded AMPLIMITE .050 Series, Slimline Connectors

Instruction Sheets provide instructions for assembling or applying product. They are intended for Manufacturing Assembler or Operator.

408-9663 Mass Insertion Tooling—**Part No. 91291-□**
 408-6923 AMP Manual Arbor Frame—**Part No. 58024-1**
 408-9701 Wire Termination Tooling Kit for CHAMPOMATOR 2.5 Machine—**Part No. 1-762661-4**
 408-7777 AMP Manual Arbor Frame w/Slide—**Part No. 91085-2**
 408-9746 Crimper Assembly—**Part No. 856684-1**
 408-9200 Single Wire Insertion Tool—**Part No. 58430-1**
 408-9721 Die Holder Assembly for Pneumatic Crimper—**Part No. 58449-□**
 408-9788 Die Assembly—**Part No. 90437-1**
 408-9898 Backshell and Cover Tooling Assemblies—**Part No. 543521-1** and **543522-1**

Customer Manuals provide information on TE termination equipment. They are intended for Manufacturing Assemblers or Operators.

409-5786 CHAMPOMATOR 2.5 Machine
 409-5791 CHAMPOMATOR 2.5 Control Module—**Part No. 852423-□**
 409-5822 Pneumatic Crimper—**Part No. 312522-3**
 409-5843 Pneumatic Power Unit

Note: All part numbers are RoHS compliant.

AMPLIMITE .050 Series Panel Mount Receptacle Assemblies for .025 [0.64] Centerline Ribbon Cable, Series III

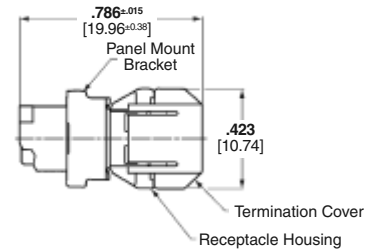
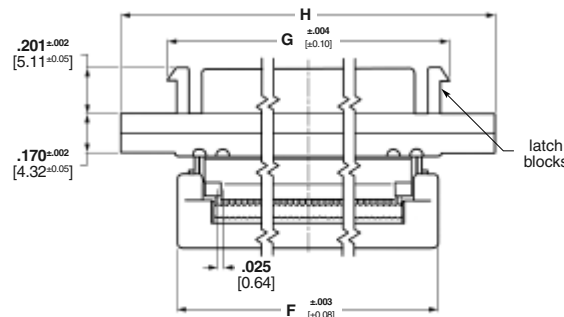

Materials:

Housing and Termination Covers—

Thermoplastic, 94V-0 rated, black

Shell—Steel, plated bright tin over copper

Bracket—Zinc, plated nickel over copper

Contacts—Phosphor bronze, duplex plated .000030 [0.00076] min. gold on mating end; tin on solder end; all nickel underplated

Recommended wire size—
 .025 [0.64] centerline, 30 AWG [0.05mm²] and 32 AWG [0.03mm²] solid or 7 strand, PVC, flat ribbon cable. Selection of compatible ribbon cable is the responsibility of the user.

Technical Documents:

See customer drawings for Product Performance criteria.

■ Recognized under the Component Program of Underwriters Laboratories, Inc., File No. E28476

■ Certified by Canadian Standards Association, File No. LR 7189

No. of Pos.	Dimensions				Gold Plating	Mating Hardware	Part No.
	E	F	G	H			
50	1.831	1.602	N/A	2.066	15μ	w/ 4-40 threaded holes	1-5390378-5
	46.50	40.70		52.47			
	1.831	1.602	N/A	2.066	30μ	w/ 4-40 threaded holes	5390378-5
	46.50	40.70		52.47			
	1.831	1.602	1.664	2.066	flash	w/ latch blocks and 4-40 threaded holes	2-5390399-5
	46.50	40.70	42.27	52.47			
68	1.831	1.602	1.664	2.066	15μ	w/ latch blocks and 4-40 threaded holes	1-5390399-5
	46.50	40.70	42.27	52.47			
	1.831	1.602	1.664	2.066	30μ	w/ latch blocks and 4-40 threaded holes	5390399-5
	46.50	40.70	42.27	52.47			
	1.831	1.602	1.664	2.066	30μ	w/ latch blocks and 2-56 threaded holes	5390379-5
	46.50	40.70	42.27	52.47			
68	2.281	2.018	N/A	2.516	15μ	w/ 4-40 threaded holes	1-5390378-7
	57.93	51.50		63.90			
	2.281	2.018	N/A	2.516	30μ	w/ 4-40 threaded holes	5390378-7
	57.93	51.50		63.90			
	2.281	2.018	2.114	2.516	flash	w/ latch blocks and 4-40 threaded holes	2-5390399-7
	57.93	51.50	53.70	63.90			
68	2.281	2.018	2.114	2.516	15μ	w/ latch blocks and 4-40 threaded holes	1-5390399-7
	57.93	51.50	53.70	63.90			
	2.281	2.018	2.114	2.516	30μ	w/ latch blocks and 4-40 threaded holes	5390399-7
	57.93	51.50	53.70	63.90			

Note: Termination Tooling: Manual Arbor Press Part No. 91085-2 or Pneumatic Press Part No. 91112-3, Universal Base Tool Part No. 768338-4, and Connector Specific Kit Part No. 1490479-1.

Note: All part numbers are RoHS compliant.



Компания «ЭлектроПласт» предлагает заключение долгосрочных отношений при поставках импортных электронных компонентов на взаимовыгодных условиях!

Наши преимущества:

- Оперативные поставки широкого спектра электронных компонентов отечественного и импортного производства напрямую от производителей и с крупнейших мировых складов;
- Поставка более 17-ти миллионов наименований электронных компонентов;
- Поставка сложных, дефицитных, либо снятых с производства позиций;
- Оперативные сроки поставки под заказ (от 5 рабочих дней);
- Экспресс доставка в любую точку России;
- Техническая поддержка проекта, помощь в подборе аналогов, поставка прототипов;
- Система менеджмента качества сертифицирована по Международному стандарту ISO 9001;
- Лицензия ФСБ на осуществление работ с использованием сведений, составляющих государственную тайну;
- Поставка специализированных компонентов (Xilinx, Altera, Analog Devices, Intersil, Interpoint, Microsemi, Aeroflex, Peregrine, Syfer, Eurofarad, Texas Instrument, Miteq, Cobham, E2V, MA-COM, Hittite, Mini-Circuits, General Dynamics и др.);

Помимо этого, одним из направлений компании «ЭлектроПласт» является направление «Источники питания». Мы предлагаем Вам помощь Конструкторского отдела:

- Подбор оптимального решения, техническое обоснование при выборе компонента;
- Подбор аналогов;
- Консультации по применению компонента;
- Поставка образцов и прототипов;
- Техническая поддержка проекта;
- Защита от снятия компонента с производства.



Как с нами связаться

Телефон: 8 (812) 309 58 32 (многоканальный)

Факс: 8 (812) 320-02-42

Электронная почта: org@eplast1.ru

Адрес: 198099, г. Санкт-Петербург, ул. Калинина, дом 2, корпус 4, литера А.