

SPECIFICATION

Part No.	: GWLA.01
Description	: GPS L1/GALILEO & Bluetooth/Wi-Fi 2.4GHz Embedded 2in1 Ceramic Loop Antenna
Features	: High Efficiency Omnidirectional Simplifies GPS/GALILEO and 2.4GHz Circuits Multi-Band Application 1575.42MHz and 2.4GHz Two Separate feeds on one antenna Low Profile 3.2*1.6*0.5mm Economical Compact Size Surface-Mount RoHS Compliant

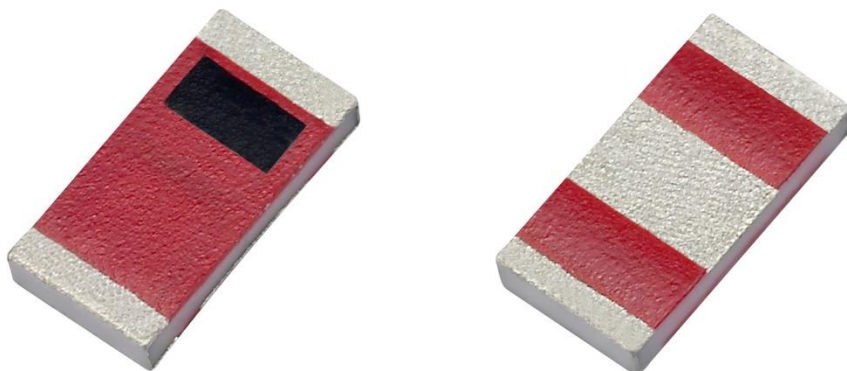

1. Introduction

The GWLA.01 GPS/GALILEO / 2.4GHz embedded loop antenna is a high efficiency, miniature SMD, edge mounted ceramic antenna for GPS/GALILEO and 2.4GHz Wi-Fi, WLAN, ZigBee, Bluetooth, and 802.11 applications. It is particularly useful where PCB space is limited. Customers can use this antenna for GPS/GALILEO and 2.4GHz (Wi-Fi or Bluetooth) modules. Rather than using two separate chip antennas for GPS/GALILEO and 2.4GHz, the GWLA.01 has two separate antenna feeds, one for each, making it the ideal choice for applications where there is limited PCB space. The GWLA.01 uses the main PCB as its ground plane, thereby maintaining good efficiency despite its small size. The GWLA.01 can be tuned for different PCB sizes/environments by simply changing the values of the matching circuit. It is ideally mounted on the center edge of a ground-plane.

At 3.2*1.6*0.5mm, the GWLA.01 is one of the smallest combination embedded antennas available worldwide. This antenna is delivered on tape and reel.

Typical Applications – where both GPS/GALILEO and 2.4GHz are required

- Navigation or Position Tracking Systems
- Handheld Devices
- Tablet PCs
- OBD Devices
- Gateways and Routers
- Mobile Cameras
- UAV Communication Systems

Many module manufacturers specify peak gain limits for any antennas that are to be connected to that module. Those peak gain limits are based on free-space conditions. In practice, the peak gain of an antenna tested in free-space can degrade by at least 1 or 2 dBi when put inside a device. So ideally you should go for a slightly higher peak gain antenna than mentioned on the module specification to compensate for this effect, giving you better performance.

Upon testing of any of our antennas with your device and a selection of appropriate layout, integration technique, or cable, Taoglas can make sure any of our antennas' peak gain will be below the peak gain limits. Taoglas can then issue a specification and/or report for the selected antenna in your device that will clearly show it complying with the peak gain limits, so you can be assured you are meeting regulatory requirements for that module.

For example, a module manufacturer may state that the antenna must have less than 2 dBi peak gain, but you don't need to select an embedded antenna that has a peak gain of less than 2 dBi in free-space. This will give you a less optimized solution. It is better to go for a slightly higher free-space peak gain of 3 dBi or more if available. Once that antenna gets integrated into your device, performance will degrade below this 2 dBi peak gain due to the effects of GND plane, surrounding components, and device housing. If you want to be absolutely sure, contact Taoglas and we will test. Choosing a Taoglas antenna with a higher peak gain than what is specified by the module manufacturer and enlisting our help will ensure you are getting the best performance possible without exceeding the peak gain limits.

2. Specification

ELECTRICAL		
Application Bands	GPS/GALILEO Antenna	Wi-Fi /Bluetooth Antenna
Frequency (MHz)	1575.42	2400-2500
Bandwidth (MHz)	32 (RL<-10dB)	100 (RL<-10dB)
Peak Gain (dBi)	1.52	1.43
Efficiency (%)	58.94	67.63
Return Loss	< -10	< -10
Isolation (dB)	> 20	> 6
Impedance	50Ω	
Polarization	Linear	
Input Power	10W	
MECHANICAL		
Dimensions (mm)	3.2*1.6*0.5	
Ground plane (mm)	80*40 (Standard Evaluation Board)	
Weight (g)	0.02	
ENVIRONMENTAL		
Operating Temperature	-40°C to 85°C	
Storage Temperature	-40°C to 85°C	
Relative Humidity	20% to 70%	

* Tested on 80*40mm evaluation board.

3. Antenna Characteristics

3.1. GPS/GALILEO Band

3.1.1. Return Loss

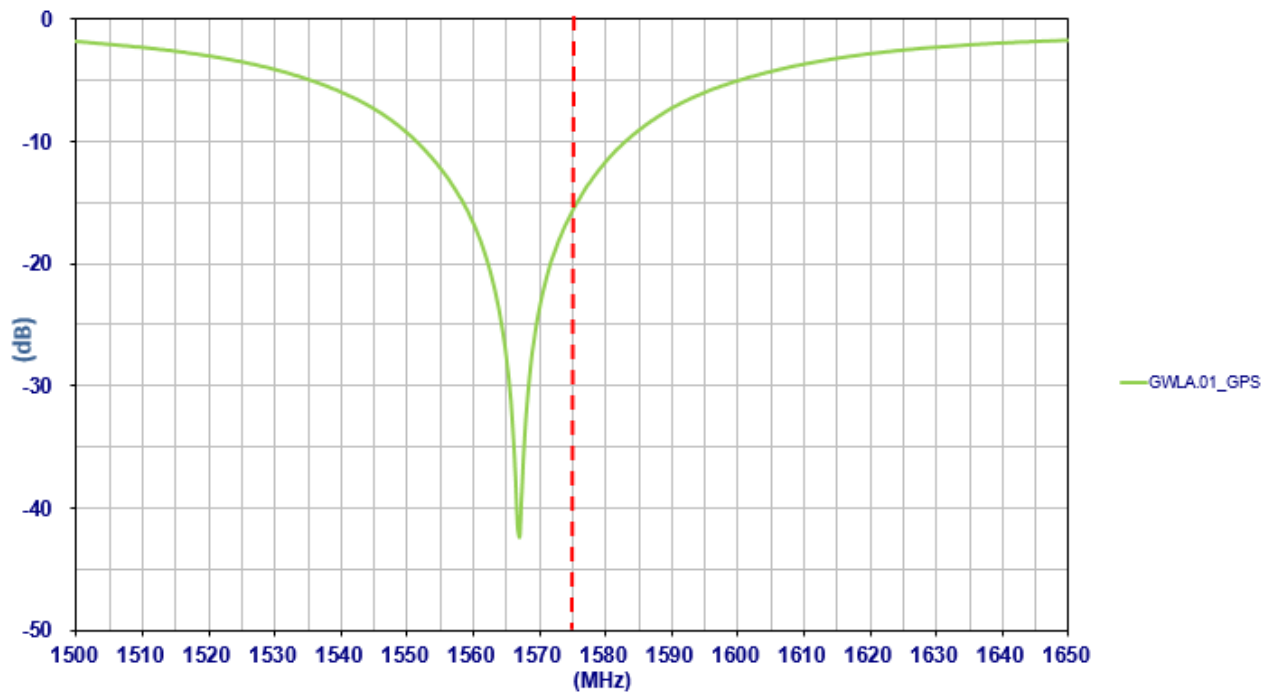

3.1.2. Efficiency

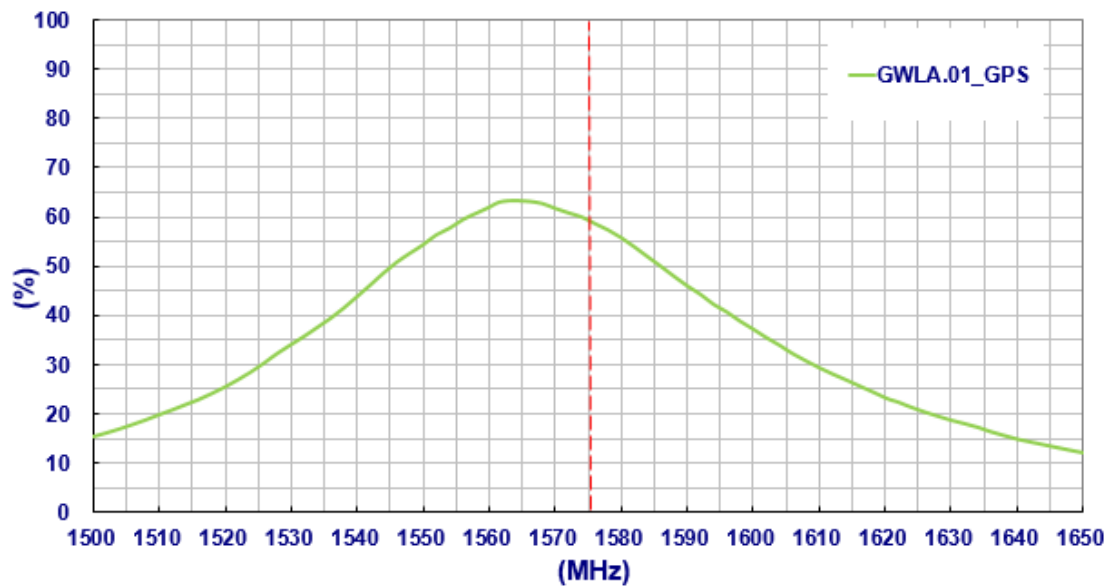

3.1.3. Peak Gain

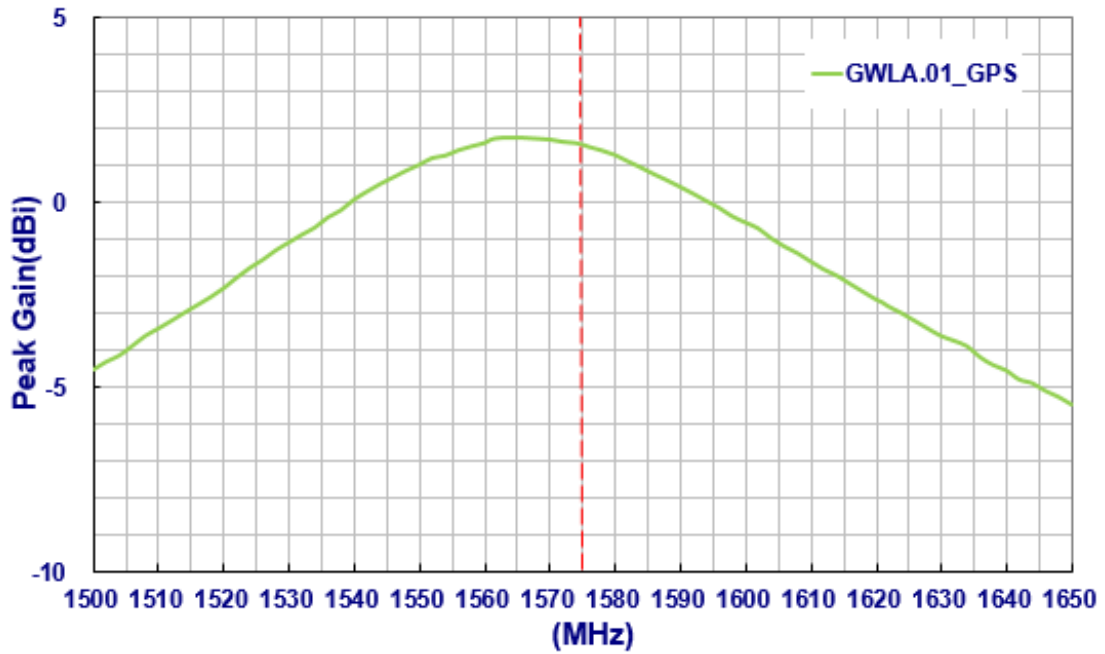

3.2. Wi-Fi

3.2.1. Return Loss

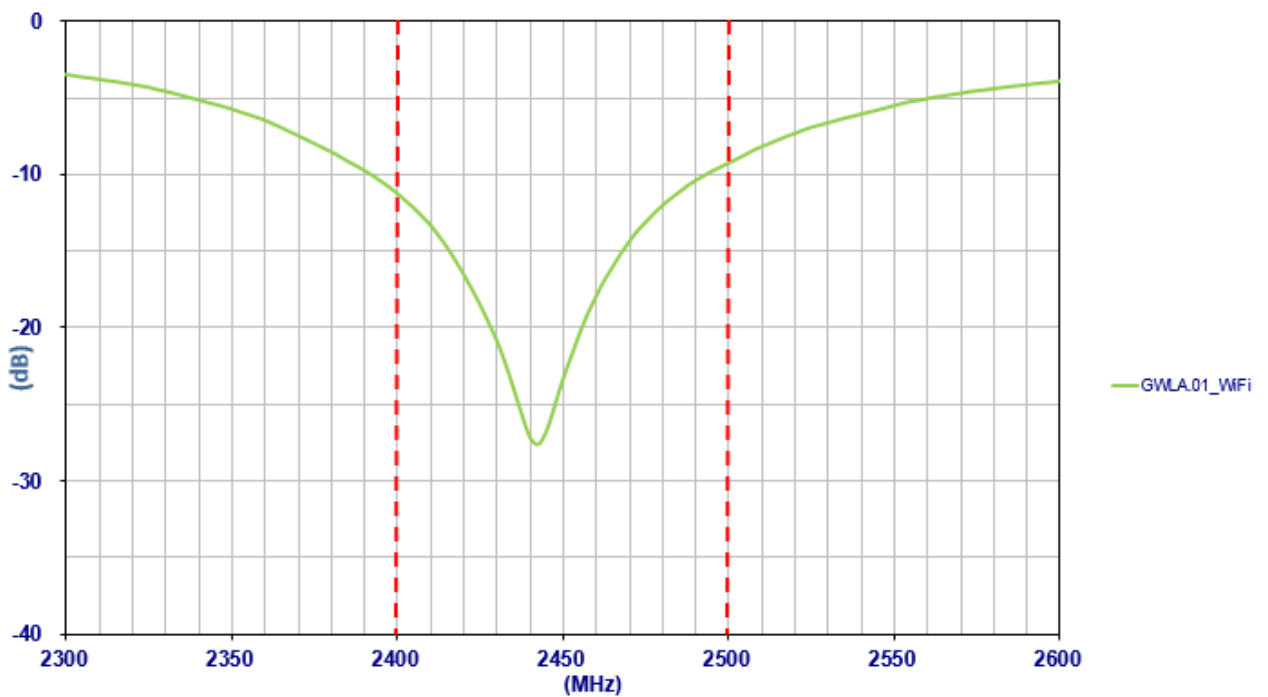

3.2.2. Efficiency

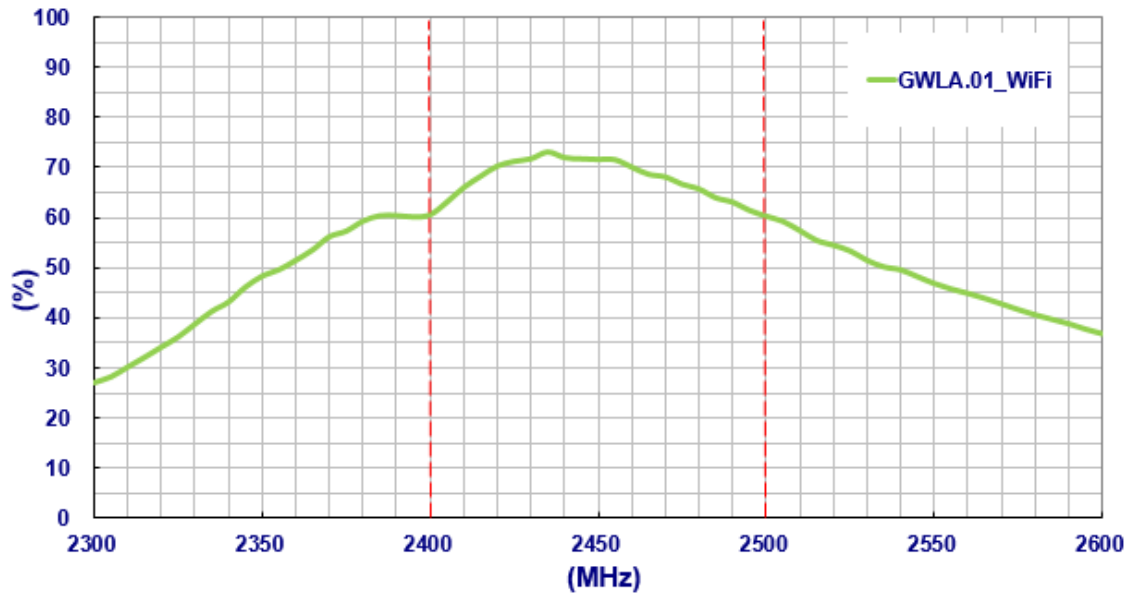

3.2.3. Peak Gain

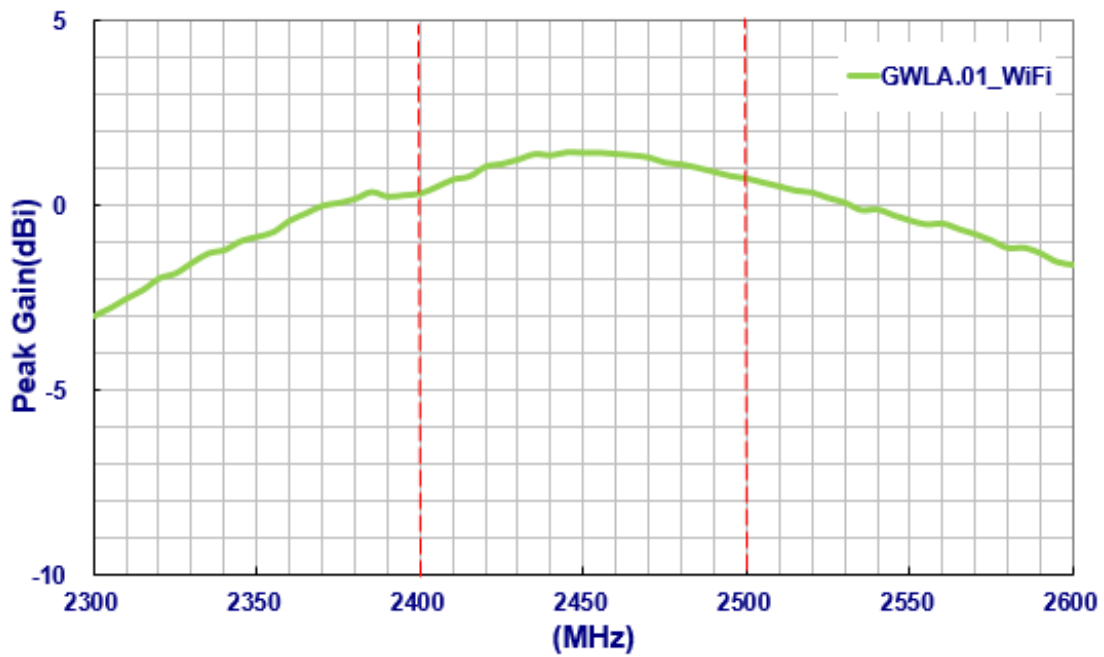

3.3. Isolation between Wi-Fi and GPS/GALILEO Antennas

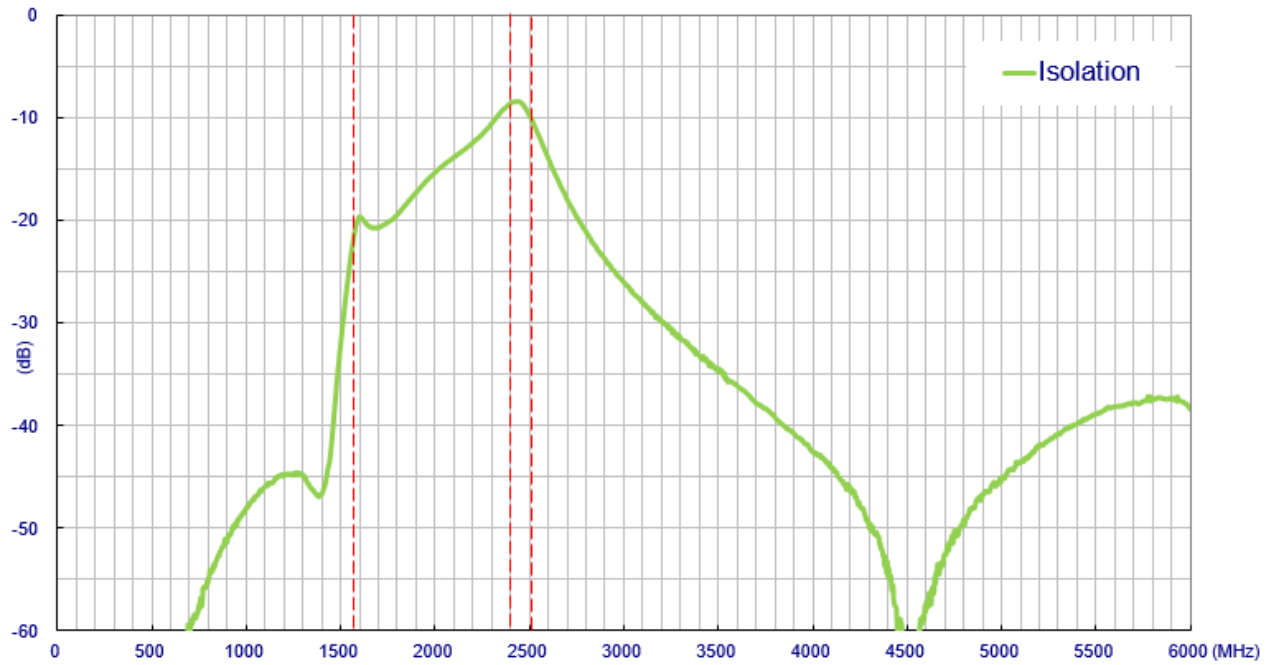

4. Antenna Radiation Pattern

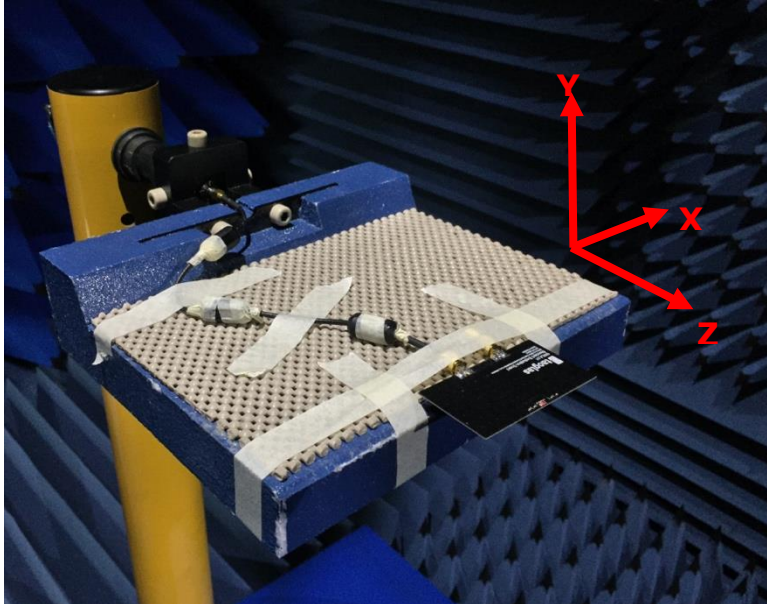

4.1. 2D Radiation Pattern (GPS/GALILEO)

XY Plane

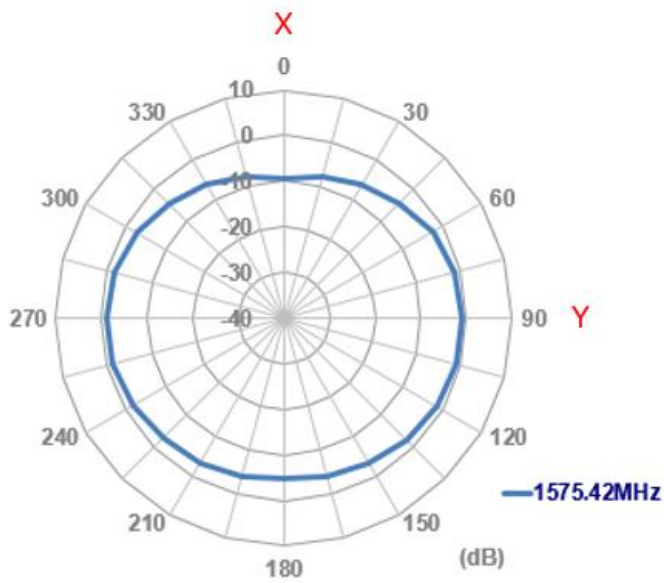

XZ Plane

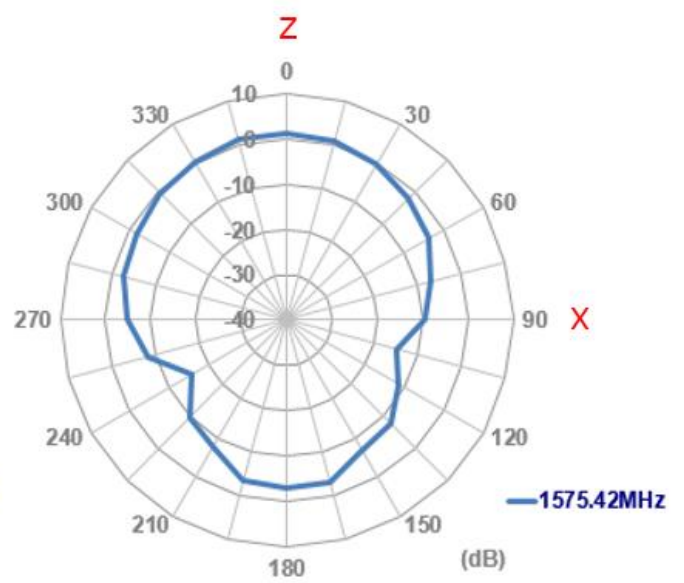

YZ

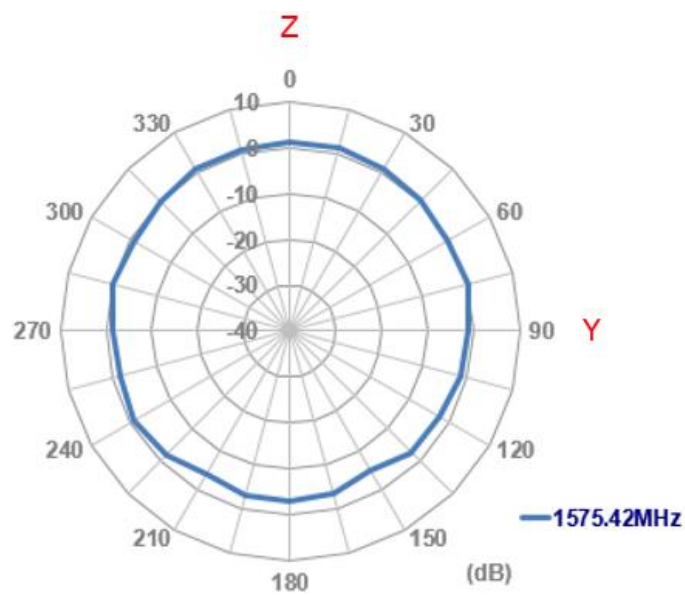

Plane

4.2. 2D Radiation Pattern (Wi-Fi(BT))

XY Plane

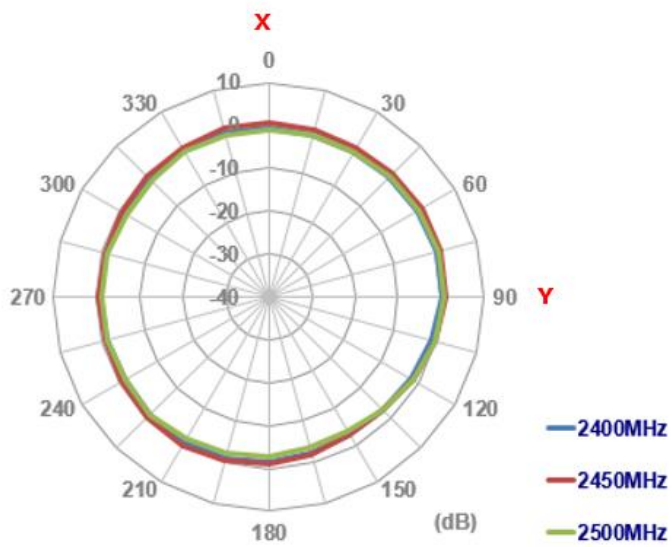

ZX Plane

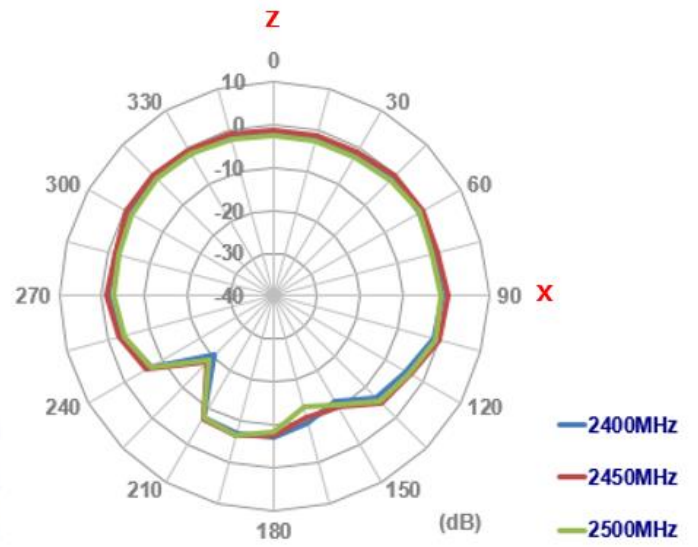

YZ Plane

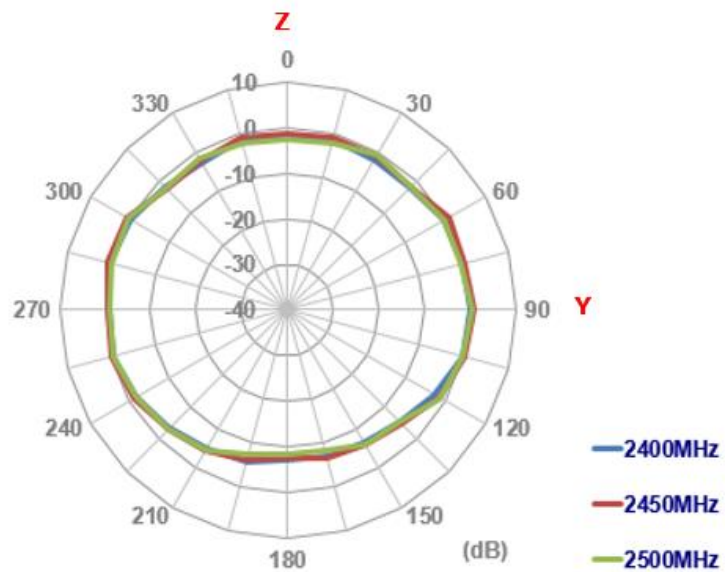

4.3. 3D Radiation Pattern (GPS/GALILEO @1575.42MHz)

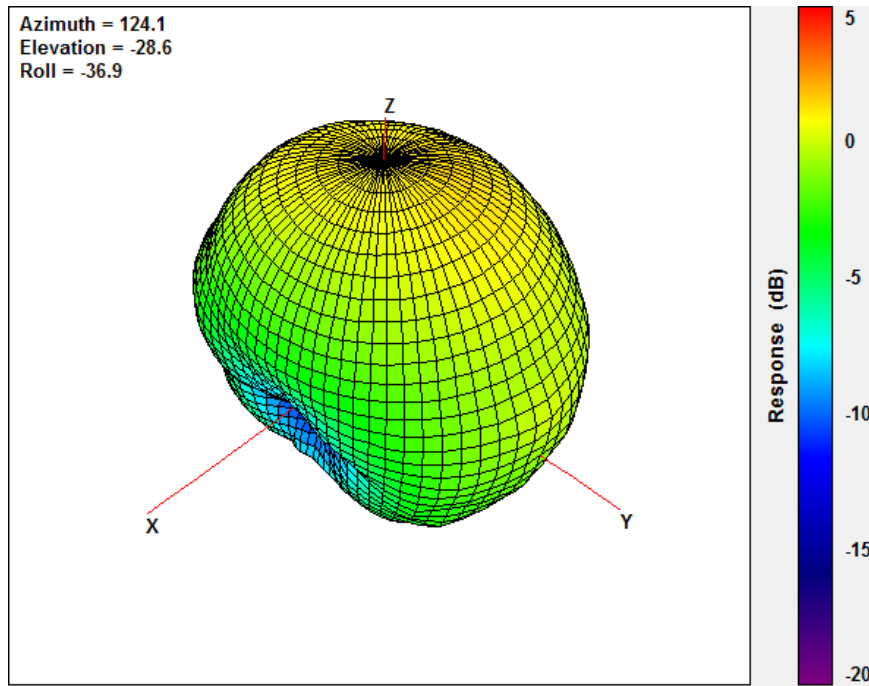

4.4. 3D Radiation Pattern (Wi-Fi(BT))

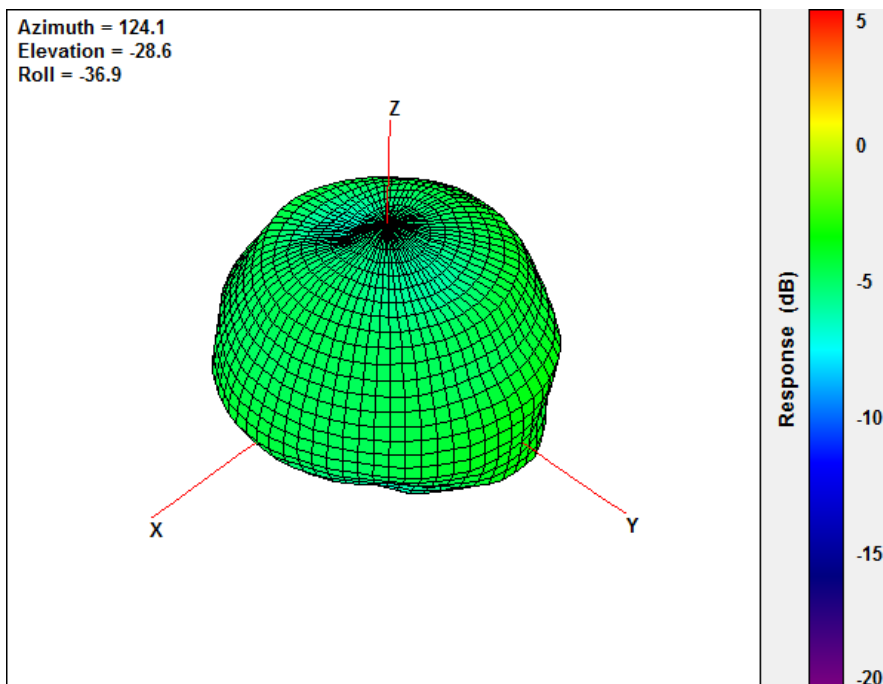

5. Mechanical Drawing (Unit: mm)

5.1. GWLA.01

Front View

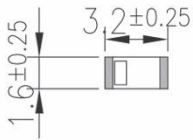

Side View

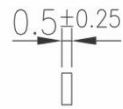

Back View

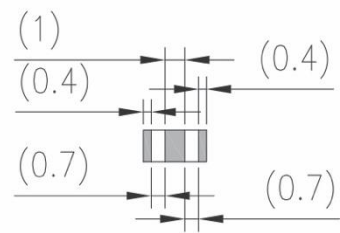

5.2. GWLAD.01

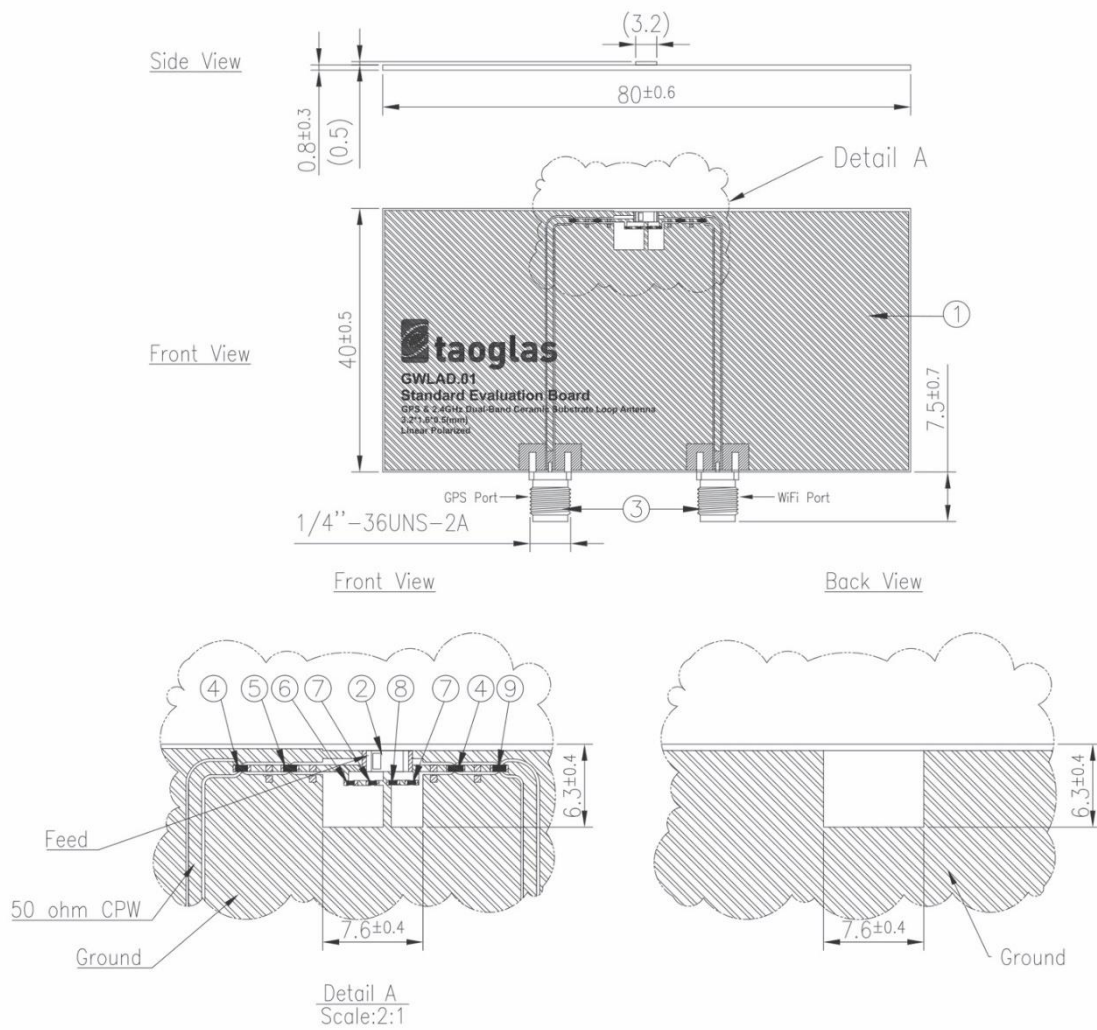





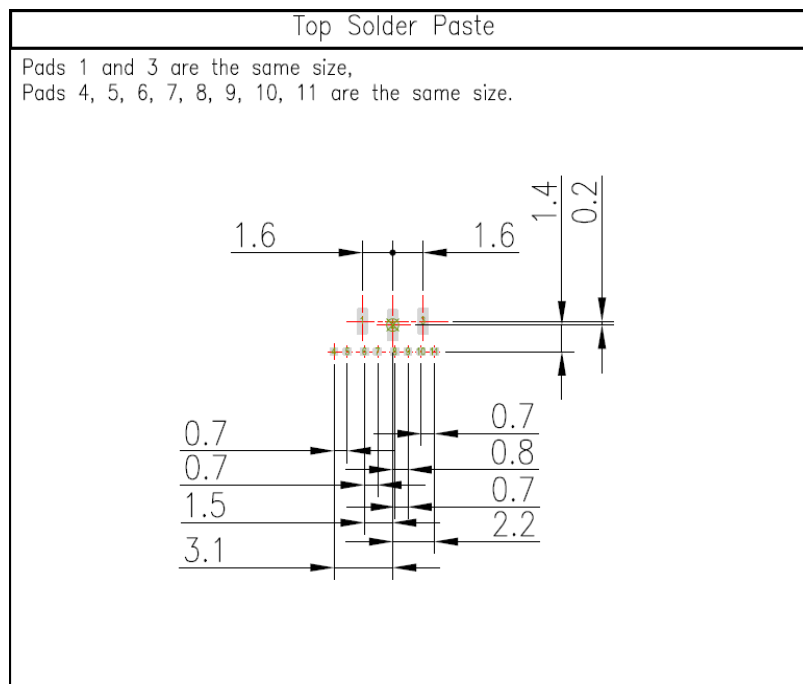
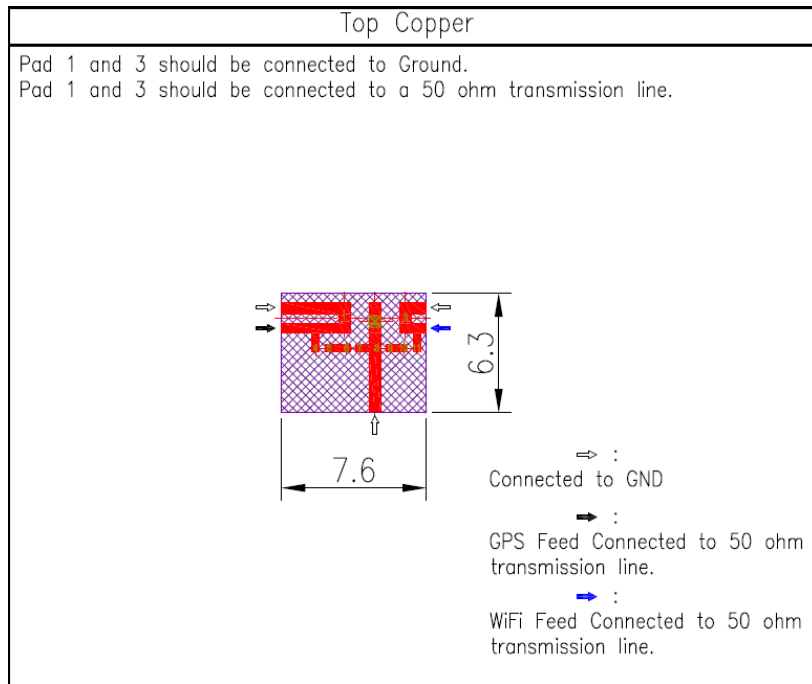

	Name	Material	Finish	QTY
1	GWLAD.01 EVB Board	Composite	Black	1
2	GWL.A.01 Chip Antenna	Ceramic	N/A	1
3	SMA(F) ST	Brass	Au Plated	2
4	Capacitor 22pF (0402)	Ceramic	N/A	2
5	Inductor 4.7nH (0402)	Ceramic	N/A	1
6	0Ω Resistor (0201)	Ceramic	N/A	1
7	Capacitor 0.7pF (0201)	Ceramic	N/A	2
8	Capacitor 0.6pF (0201)	Ceramic	N/A	1
9	Capacitor 6.8pF (0402)	Ceramic	N/A	1

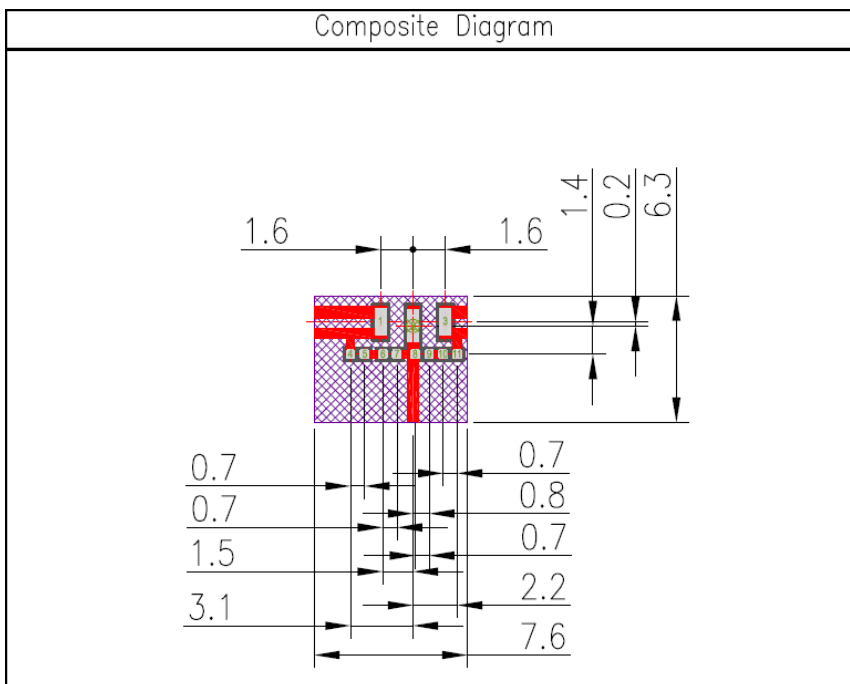
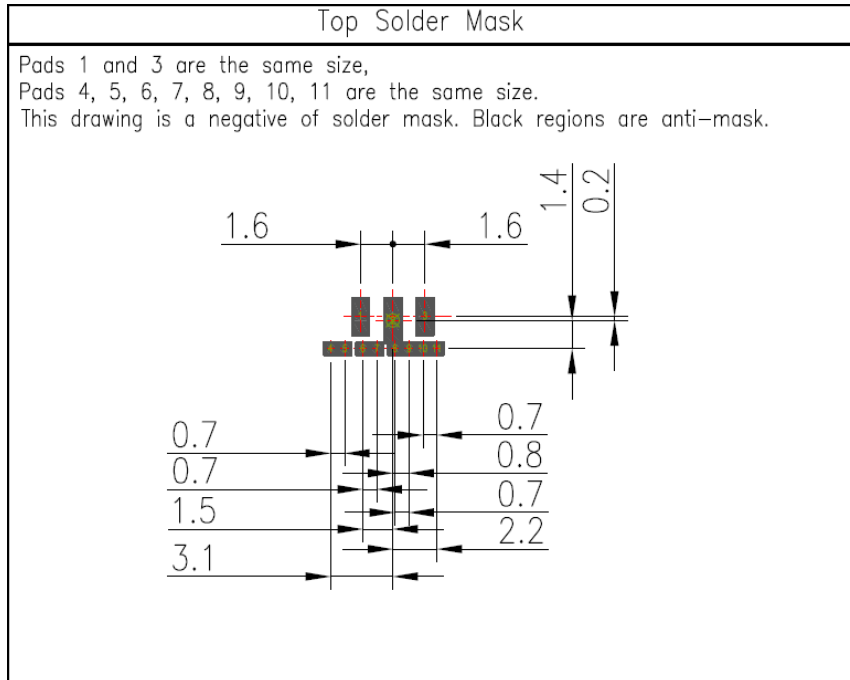
6. Layout Guide

6.1. Footprint





- NOTE:
- | | | |
|------------------------|---|--|
| 1. Ag Plated area |  | 6. Ground keepout should extend from top layer through all inner PCB layers to minimize coupling from RF feed to ground. |
| 2. Solder Mask area |  | 7. Any vias in pads should be either filled or tented to prevent solder from wicking away from the pad during reflow. |
| 3. Copper area |  | 8. The dimension tolerances should follow standard PCB manufacturing guidelines |
| 4. Paste area |  | |
| 5. Copper Keepout Area |  | |

* Footprint drawings in .dwg format will be provided upon request.

6.2. Matching Circuit

Like all antennas, surrounding components, enclosures, and changes to the GND plane dimensions can alter performance. A pi-matching network like the one shown below is required incase adjustments need to be made. The antenna EVB has the same matching network. The components on the EVB are a good starting point for a new design, but will need to be adjusted upon integration for best performance. The zero ohm resistor is needed to solder down a coax pigtail to make measurements with a vector network analyzer.

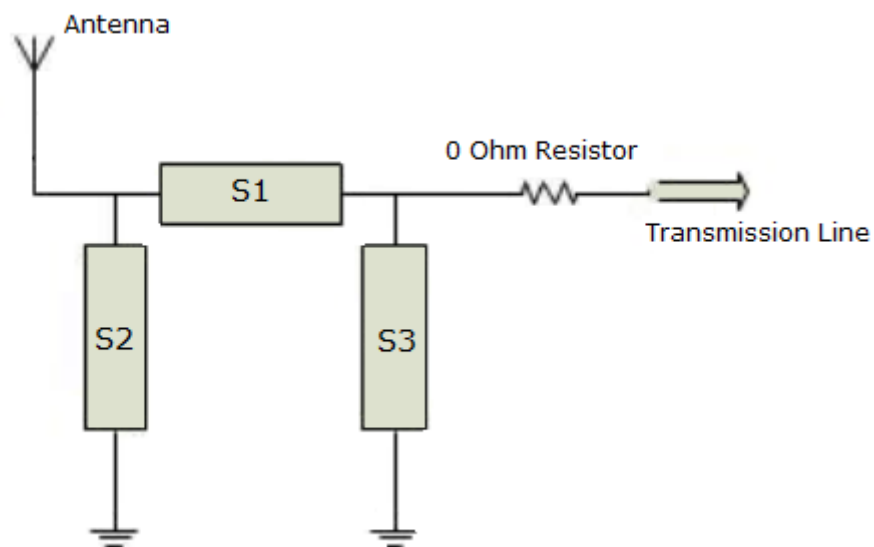

7. Solder Reflow Profile

Typical soldering profile for lead-free process:

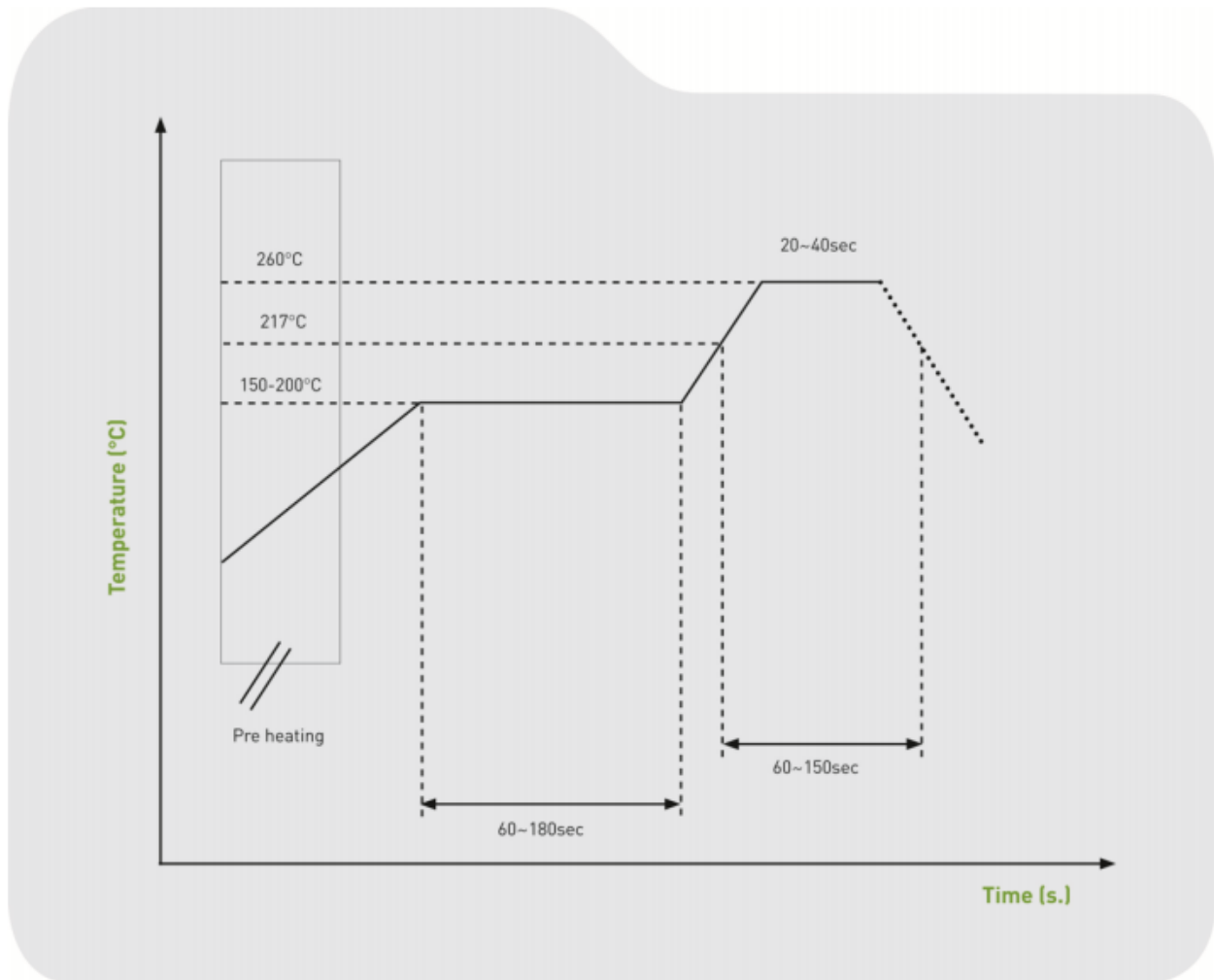

8. Packaging

5000 pcs GWLA.01 per tape & reel
 Dimensions - 330*330*17mm
 Weight - 484g

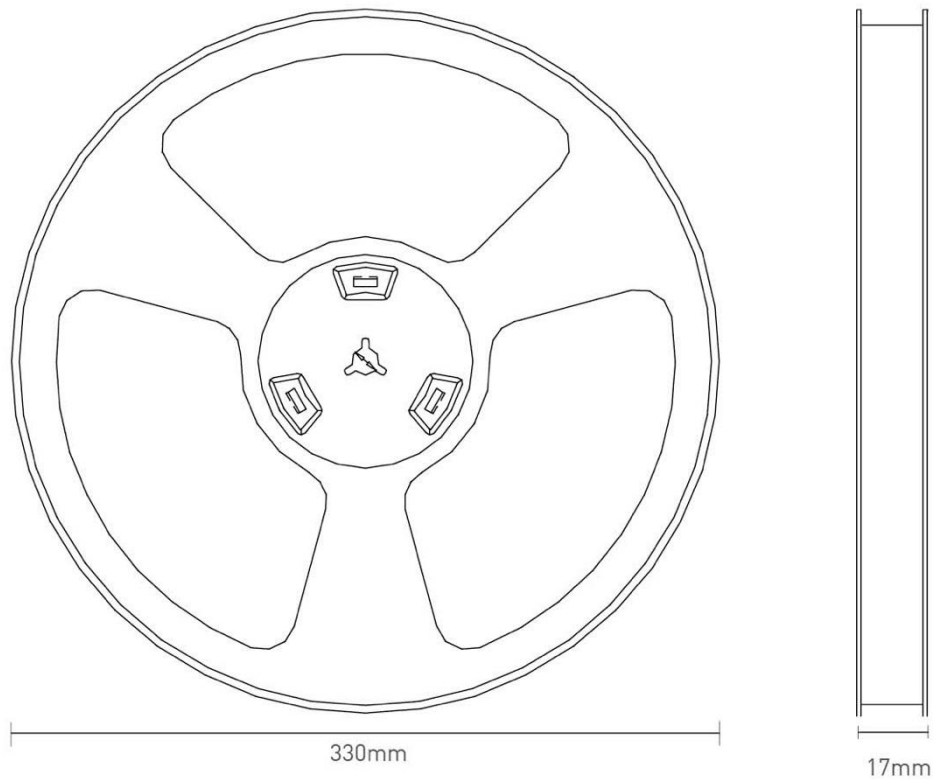

Tape Dimensions (unit: mm)		
Feature	Spec	Tolerances
W	12.00	±0.30
P	4.00	±0.10
E	1.75	±0.10
F	5.50	±0.10
P2	2.00	±0.10
D	1.50	+0.10 -0.00
Po	4.00	±0.10
10Po	40.00	±0.10

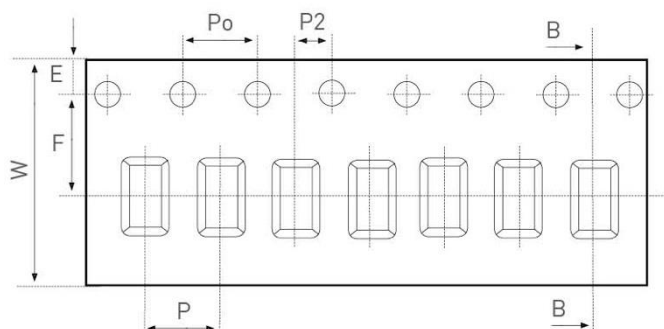

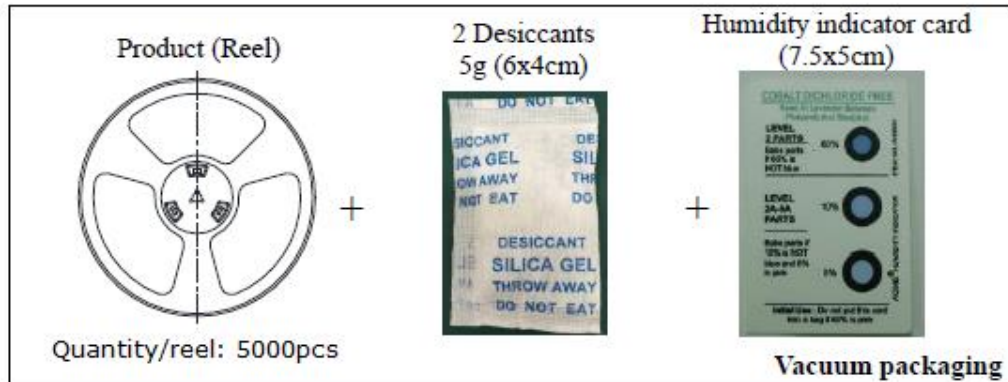

5000 pcs GWLA.01
 1 reel in small inner box
 Dimensions - 330*330*17
 Weight - 484g

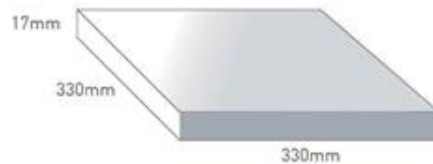

9 boxes / 45000 pcs in one carton
 Carton Dimensions - 350*350*210mm
 Weight -4.89Kg

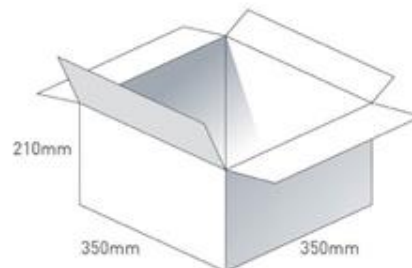

Pallet Dimensions 1220*1020*1410mm
 36 Cartons per Pallet
 4 Cartons per layer
 9 Layers

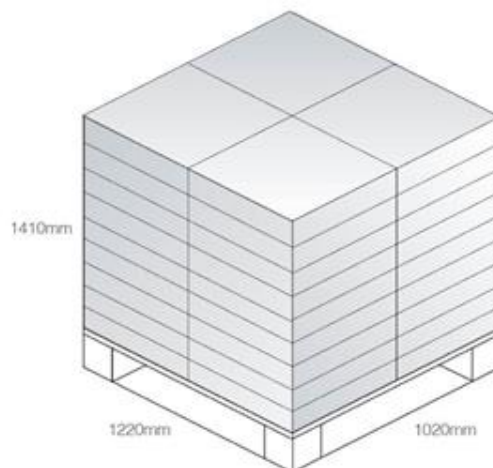

Taoglas makes no warranties based on the accuracy or completeness of the contents of this document and reserves the right to make changes to specifications and product descriptions at any time without notice. Taoglas reserves all rights to this document and the information contained herein.

Reproduction, use or disclosure to third parties without express permission is strictly prohibited.

Copyright © Taoglas Ltd.



Компания «ЭлектроПласт» предлагает заключение долгосрочных отношений при поставках импортных электронных компонентов на взаимовыгодных условиях!

Наши преимущества:

- Оперативные поставки широкого спектра электронных компонентов отечественного и импортного производства напрямую от производителей и с крупнейших мировых складов;
- Поставка более 17-ти миллионов наименований электронных компонентов;
- Поставка сложных, дефицитных, либо снятых с производства позиций;
- Оперативные сроки поставки под заказ (от 5 рабочих дней);
- Экспресс доставка в любую точку России;
- Техническая поддержка проекта, помощь в подборе аналогов, поставка прототипов;
- Система менеджмента качества сертифицирована по Международному стандарту ISO 9001;
- Лицензия ФСБ на осуществление работ с использованием сведений, составляющих государственную тайну;
- Поставка специализированных компонентов (Xilinx, Altera, Analog Devices, Intersil, Interpoint, Microsemi, Aeroflex, Peregrine, Syfer, Eurofarad, Texas Instrument, Miteq, Cobham, E2V, MA-COM, Hittite, Mini-Circuits, General Dynamics и др.);

Помимо этого, одним из направлений компании «ЭлектроПласт» является направление «Источники питания». Мы предлагаем Вам помощь Конструкторского отдела:

- Подбор оптимального решения, техническое обоснование при выборе компонента;
- Подбор аналогов;
- Консультации по применению компонента;
- Поставка образцов и прототипов;
- Техническая поддержка проекта;
- Защита от снятия компонента с производства.



Как с нами связаться

Телефон: 8 (812) 309 58 32 (многоканальный)

Факс: 8 (812) 320-02-42

Электронная почта: org@eplast1.ru

Адрес: 198099, г. Санкт-Петербург, ул. Калинина, дом 2, корпус 4, литера А.