

# BDX53B, BDX53C (NPN), BDX54B, BDX54C (PNP)

## Plastic Medium-Power Complementary Silicon Transistors

These devices are designed for general-purpose amplifier and low-speed switching applications.

### Features

- High DC Current Gain –  
 $h_{FE} = 2500$  (Typ) @  $I_C = 4.0$  Adc
- Collector Emitter Sustaining Voltage – @ 100 mAdc  
 $V_{CEO(sus)} = 80$  Vdc (Min) – BDX53B, 54B  
 $= 100$  Vdc (Min) – BDX53C, 54C
- Low Collector–Emitter Saturation Voltage –  
 $V_{CE(sat)} = 2.0$  Vdc (Max) @  $I_C = 3.0$  Adc  
 $= 4.0$  Vdc (Max) @  $I_C = 5.0$  Adc
- Monolithic Construction with Built-In Base–Emitter Shunt Resistors
- Pb–Free Packages are Available\*

### MAXIMUM RATINGS

Rating	Symbol	Value	Unit
Collector–Emitter Voltage BDX53B, BDX54B BDX53C, BDX54C	$V_{CEO}$	80 100	Vdc
Collector–Base Voltage BDX53B, BDX54B BDX53C, BDX54C	$V_{CB}$	80 100	Vdc
Emitter–Base Voltage	$V_{EB}$	5.0	Vdc
Collector Current – Continuous – Peak	$I_C$	8.0 12	Adc
Base Current	$I_B$	0.2	Adc
Total Device Dissipation @ $T_C = 25^\circ\text{C}$ Derate above $25^\circ\text{C}$	$P_D$	65 0.48	W W/ $^\circ\text{C}$
Operating and Storage Junction Temperature Range	$T_J, T_{stg}$	–65 to +150	$^\circ\text{C}$

### THERMAL CHARACTERISTICS

Characteristic	Symbol	Max	Unit
Thermal Resistance, Junction–to–Ambient	$R_{\theta JA}$	70	$^\circ\text{C}/\text{W}$
Thermal Resistance, Junction–to–Case	$R_{\theta JC}$	1.92	$^\circ\text{C}/\text{W}$

Stresses exceeding Maximum Ratings may damage the device. Maximum Ratings are stress ratings only. Functional operation above the Recommended Operating Conditions is not implied. Extended exposure to stresses above the Recommended Operating Conditions may affect device reliability.

\*For additional information on our Pb–Free strategy and soldering details, please download the ON Semiconductor Soldering and Mounting Techniques Reference Manual, SOLDERRM/D.



ON Semiconductor®

<http://onsemi.com>

## DARLINGTON 8 AMPERE COMPLEMENTARY SILICON POWER TRANSISTORS 80–100 VOLTS, 65 WATTS

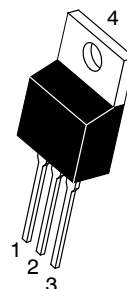

TO–220AB  
CASE 221A  
STYLE 1

### MARKING DIAGRAM & PIN ASSIGNMENT

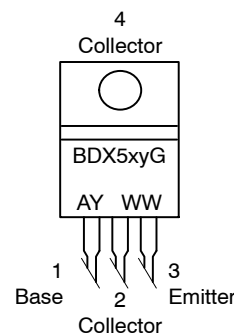

BDX5xy = Device Code  
x = 3 or 4  
y = B or C  
A = Assembly Location  
Y = Year  
WW = Work Week  
G = Pb–Free Package

### ORDERING INFORMATION

See detailed ordering and shipping information in the package dimensions section on page 6 of this data sheet.

## BDX53B, BDX53C (NPN), BDX54B, BDX54C (PNP)

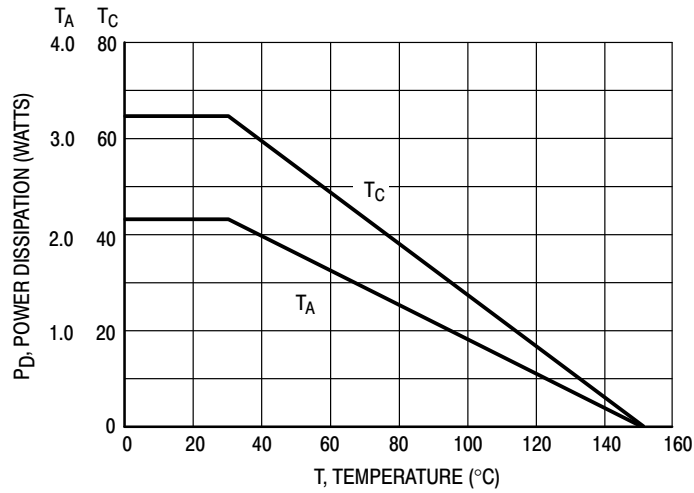

**Figure 1. Power Derating**

### ELECTRICAL CHARACTERISTICS (T<sub>C</sub> = 25°C unless otherwise noted)

Characteristic	Symbol	Min	Max	Unit	
<b>OFF CHARACTERISTICS</b>					
Collector-Emitter Sustaining Voltage (Note 1) (I <sub>C</sub> = 100 mAdc, I <sub>B</sub> = 0)	BDX53B, BDX54B BDX53C, BDX54C	V <sub>CEO(sus)</sub>	80 100	- -	Vdc
Collector Cutoff Current (V <sub>CE</sub> = 40 Vdc, I <sub>B</sub> = 0) (V <sub>CE</sub> = 50 Vdc, I <sub>B</sub> = 0)	BDX53B, BDX54B BDX53C, BDX54C	I <sub>CEO</sub>	- -	0.5 0.5	mAdc
Collector Cutoff Current (V <sub>CB</sub> = 80 Vdc, I <sub>E</sub> = 0) (V <sub>CB</sub> = 100 Vdc, I <sub>E</sub> = 0)	BDX53B, BDX54B BDX53C, BDX54C	I <sub>CBO</sub>	- -	0.2 0.2	mAdc
<b>ON CHARACTERISTICS (Note 1)</b>					
DC Current Gain (I <sub>C</sub> = 3.0 Adc, V <sub>CE</sub> = 3.0 Vdc)		h <sub>FE</sub>	750	-	-
Collector-Emitter Saturation Voltage (I <sub>C</sub> = 3.0 Adc, I <sub>B</sub> = 12 mAdc)		V <sub>CE(sat)</sub>	- -	2.0 4.0	Vdc
Base-Emitter Saturation Voltage (I <sub>C</sub> = 3.0 Adc, I <sub>B</sub> = 12 mA)		V <sub>BE(sat)</sub>	-	2.5	Vdc
<b>DYNAMIC CHARACTERISTICS</b>					
Small-Signal Current Gain (I <sub>C</sub> = 3.0 Adc, V <sub>CE</sub> = 4.0 Vdc, f = 1.0 MHz)		h <sub>fe</sub>	4.0	-	-
Output Capacitance (V <sub>CB</sub> = 10 Vdc, I <sub>E</sub> = 0, f = 0.1 MHz)	BDX53B, 53C BDX54B, 54C	C <sub>ob</sub>	- -	300 200	pF

1. Pulse Test: Pulse Width ≤ 300 μs, Duty Cycle ≤ 2%.

## BDX53B, BDX53C (NPN), BDX54B, BDX54C (PNP)

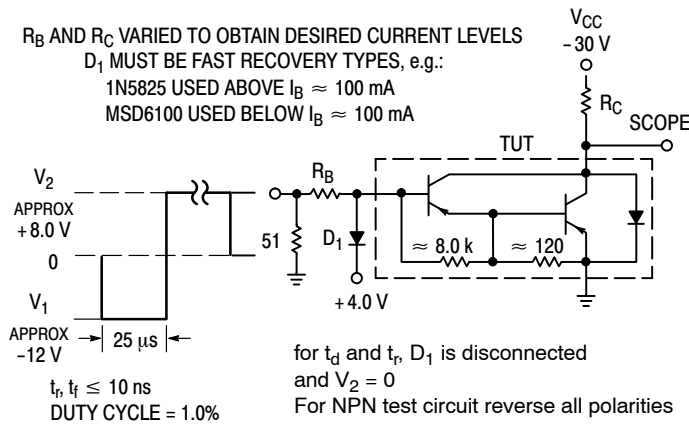

**Figure 2. Switching Time Test Circuit**

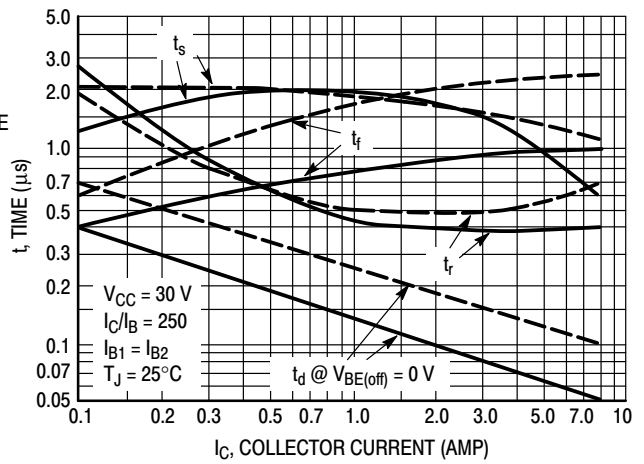

**Figure 3. Switching Times**

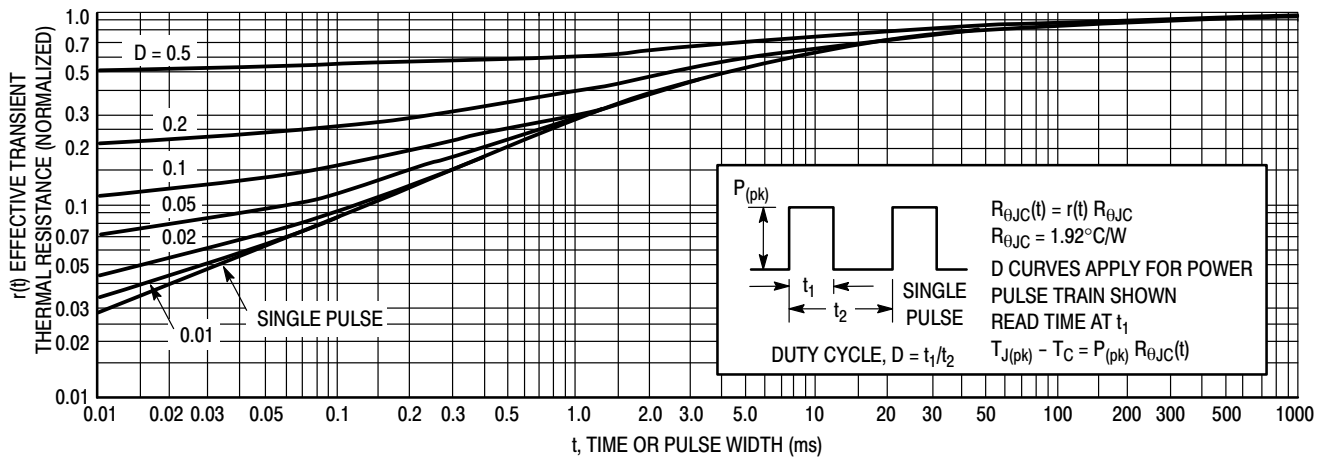

**Figure 4. Thermal Response**

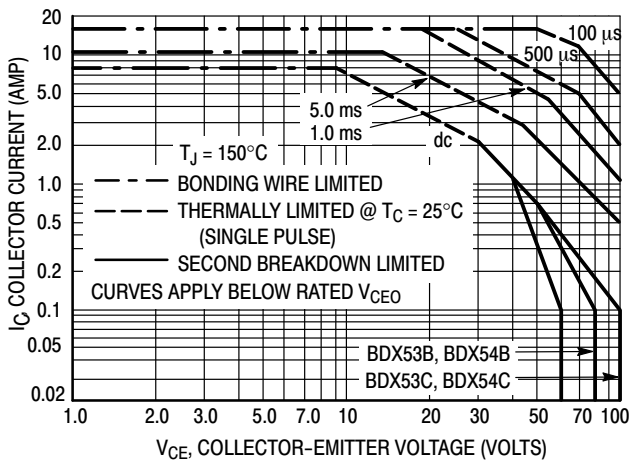

**Figure 5. Active-Region Safe Operating Area**

There are two limitations on the power handling ability of a transistor average junction temperature and second breakdown. Safe operating area curves indicate  $I_C - V_{CE}$  limits of the transistor that must be observed for reliable operation, i.e., the transistor must not be subjected to greater dissipation than the curves indicate.

The data of Figure 5 is based on  $T_{J(pk)} = 150^\circ\text{C}$ ;  $T_C$  is variable depending on conditions. Second breakdown pulse limits are valid for duty cycles to 10% provided  $T_{J(pk)} < 150^\circ\text{C}$ .  $T_{J(pk)}$  may be calculated from the data in Figure 4. At high case temperatures, thermal limitations will reduce the power that can be handled to values less than the limitations imposed by second breakdown.

# BDX53B, BDX53C (NPN), BDX54B, BDX54C (PNP)

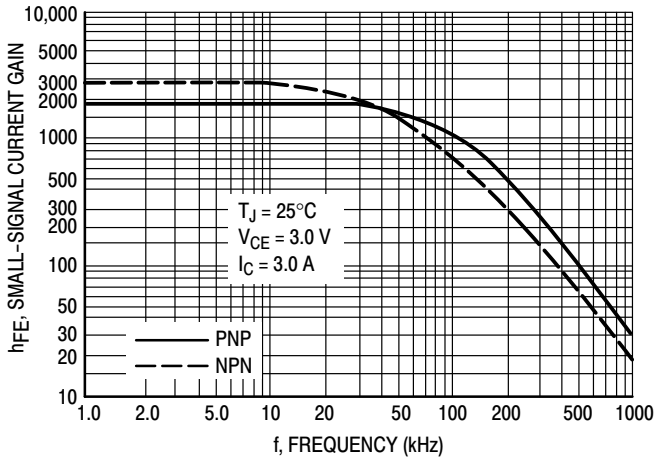

Figure 6. Small-Signal Current Gain

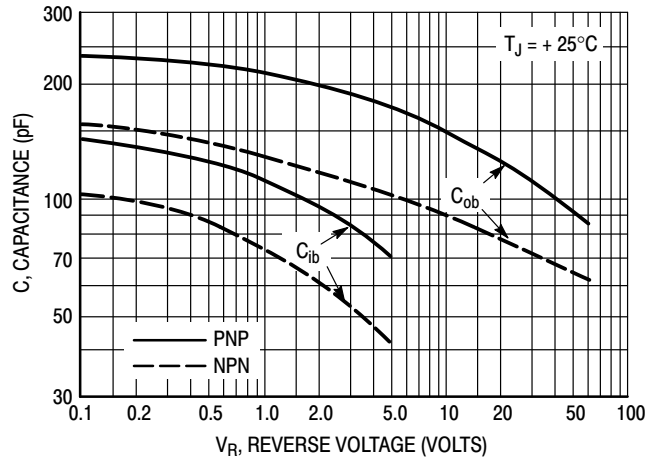
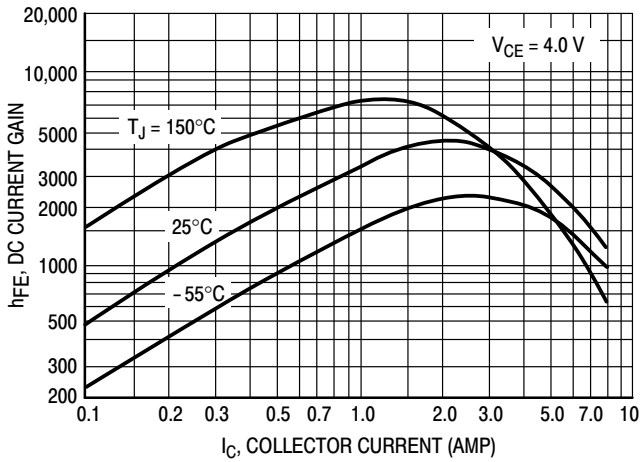

Figure 7. Capacitance

**NPN**  
**BDX53B, 53C**



**PNP**  
**BDX54B, 54C**

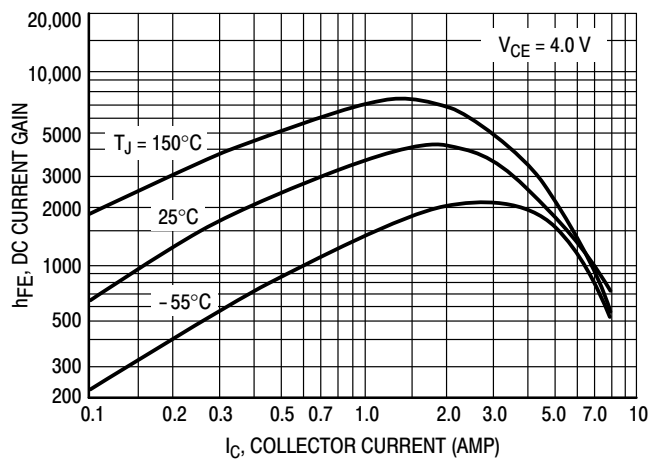

Figure 8. DC Current Gain

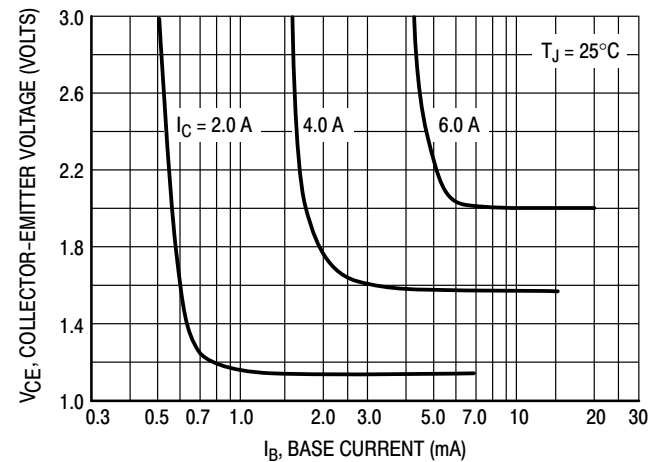
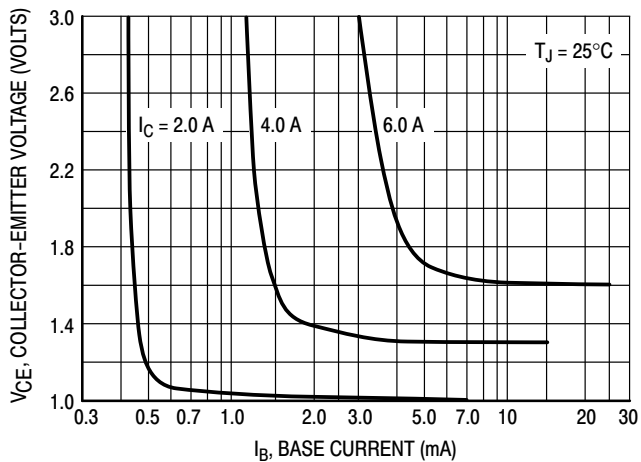

Figure 9. Collector Saturation Region

## BDX53B, BDX53C (NPN), BDX54B, BDX54C (PNP)

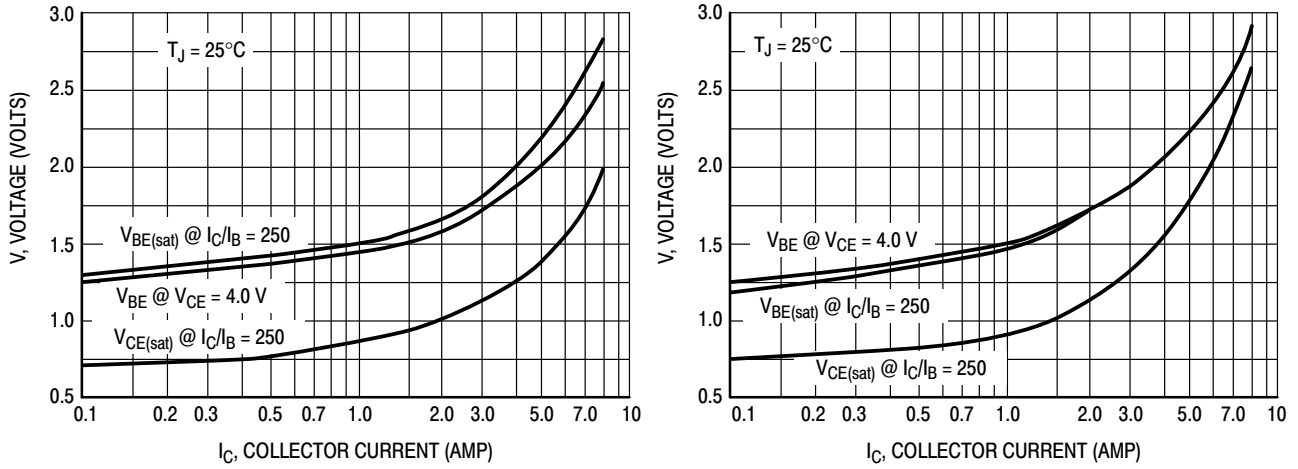

Figure 10. "On" Voltages

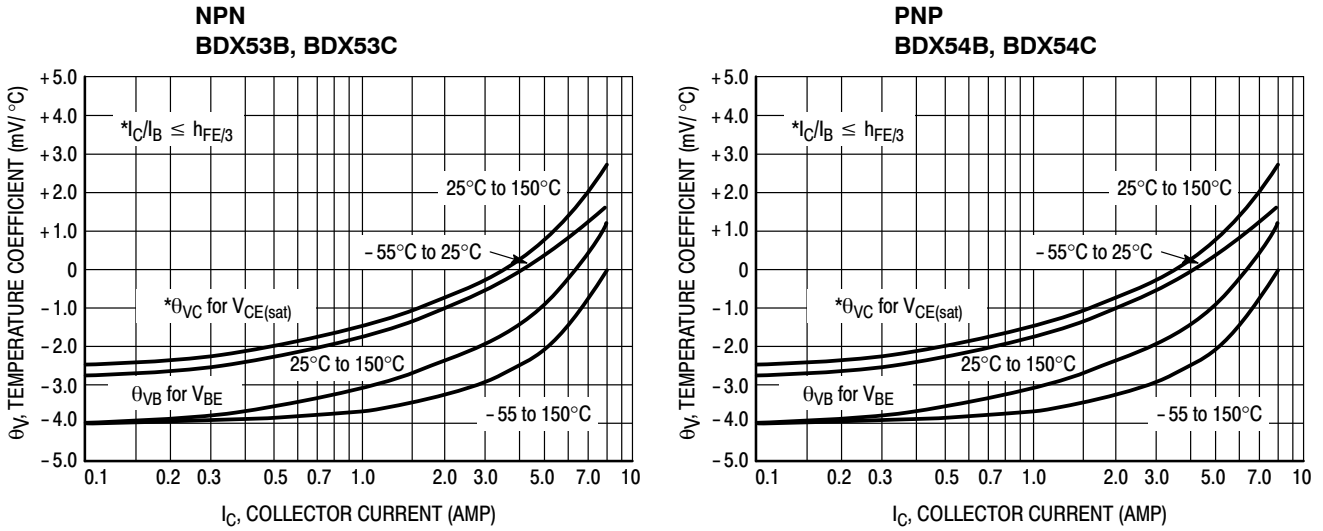

Figure 11. Temperature Coefficients

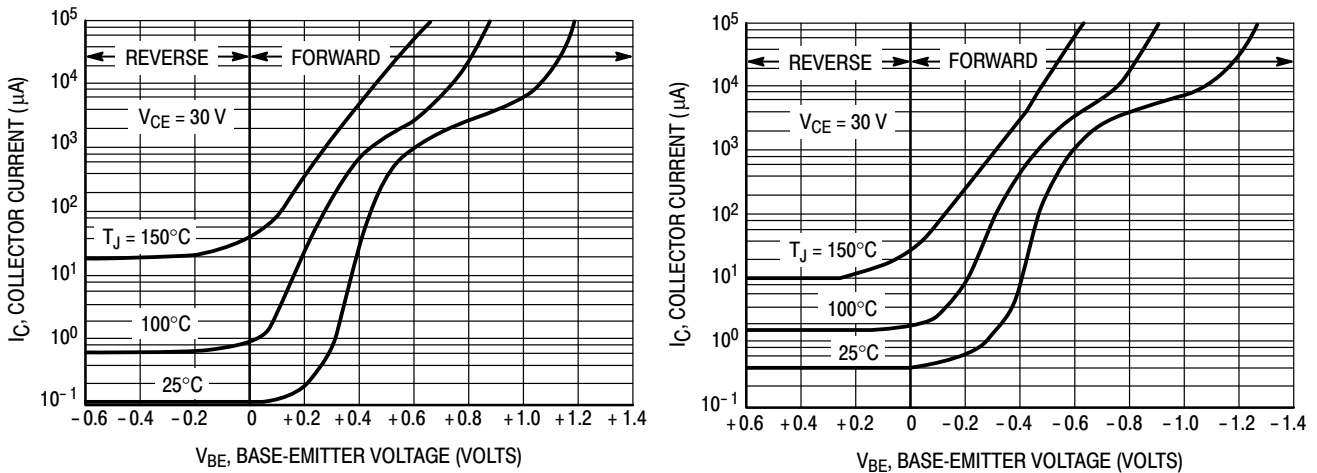

Figure 12. Collector Cut-Off Region

## BDX53B, BDX53C (NPN), BDX54B, BDX54C (PNP)



**Figure 13. Darlington Schematic**

### ORDERING INFORMATION

Device	Package	Shipping <sup>†</sup>
BDX53B	TO-220	50 Units / Rail
BDX53BG	TO-220 (Pb-Free)	
BDX53C	TO-220	50 Units / Rail
BDX53CG	TO-220 (Pb-Free)	
BDX54B	TO-220	50 Units / Rail
BDX54BG	TO-220 (Pb-Free)	
BDX54C	TO-220	50 Units / Rail
BDX54CG	TO-220 (Pb-Free)	

<sup>†</sup>For information on tape and reel specifications, including part orientation and tape sizes, please refer to our Tape and Reel Packaging Specifications Brochure, BRD8011/D.

# BDX53B, BDX53C (NPN), BDX54B, BDX54C (PNP)

## PACKAGE DIMENSIONS

### TO-220 CASE 221A-09 ISSUE AG

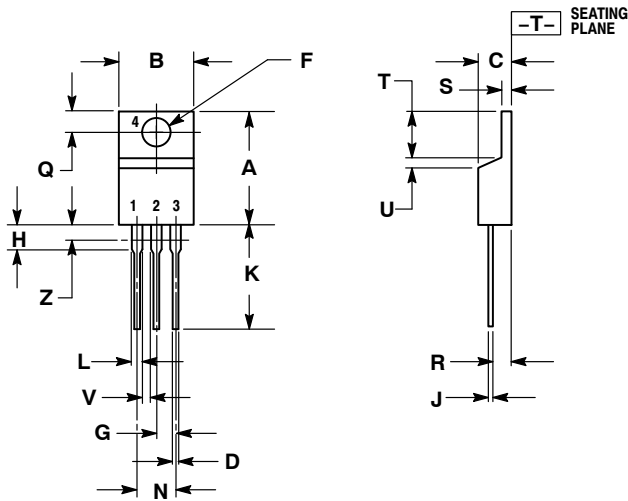

#### NOTES:

1. DIMENSIONING AND TOLERANCING PER ANSI Y14.5M, 1982.
2. CONTROLLING DIMENSION: INCH.
3. DIMENSION Z DEFINES A ZONE WHERE ALL BODY AND LEAD IRREGULARITIES ARE ALLOWED.

DIM	INCHES		MILLIMETERS	
	MIN	MAX	MIN	MAX
A	0.570	0.620	14.48	15.75
B	0.380	0.405	9.66	10.28
C	0.160	0.190	4.07	4.82
D	0.025	0.036	0.64	0.91
F	0.142	0.161	3.61	4.09
G	0.095	0.105	2.42	2.66
H	0.110	0.161	2.80	4.10
J	0.014	0.025	0.36	0.64
K	0.500	0.562	12.70	14.27
L	0.045	0.060	1.15	1.52
N	0.190	0.210	4.83	5.33
Q	0.100	0.120	2.54	3.04
R	0.080	0.110	2.04	2.79
S	0.045	0.055	1.15	1.39
T	0.235	0.255	5.97	6.47
U	0.000	0.050	0.00	1.27
V	0.045	---	1.15	---
Z	---	0.080	---	2.04

#### STYLE 1:

- PIN 1. BASE
- 2. COLLECTOR
- 3. EMITTER
- 4. COLLECTOR

ON Semiconductor and are registered trademarks of Semiconductor Components Industries, LLC (SCILLC). SCILLC reserves the right to make changes without further notice to any products herein. SCILLC makes no warranty, representation or guarantee regarding the suitability of its products for any particular purpose, nor does SCILLC assume any liability arising out of the application or use of any product or circuit, and specifically disclaims any and all liability, including without limitation special, consequential or incidental damages. "Typical" parameters which may be provided in SCILLC data sheets and/or specifications can and do vary in different applications and actual performance may vary over time. All operating parameters, including "Typicals" must be validated for each customer application by customer's technical experts. SCILLC does not convey any license under its patent rights nor the rights of others. SCILLC products are not designed, intended, or authorized for use as components in systems intended for surgical implant into the body, or other applications intended to support or sustain life, or for any other application in which the failure of the SCILLC product could create a situation where personal injury or death may occur. Should Buyer purchase or use SCILLC products for any such unintended or unauthorized application, Buyer shall indemnify and hold SCILLC and its officers, employees, subsidiaries, affiliates, and distributors harmless against all claims, costs, damages, and expenses, and reasonable attorney fees arising out of, directly or indirectly, any claim of personal injury or death associated with such unintended or unauthorized use, even if such claim alleges that SCILLC was negligent regarding the design or manufacture of the part. SCILLC is an Equal Opportunity/Affirmative Action Employer. This literature is subject to all applicable copyright laws and is not for resale in any manner.

### PUBLICATION ORDERING INFORMATION

#### LITERATURE FULFILLMENT:

Literature Distribution Center for ON Semiconductor  
P.O. Box 5163, Denver, Colorado 80217 USA  
Phone: 303-675-2175 or 800-344-3860 Toll Free USA/Canada  
Fax: 303-675-2176 or 800-344-3867 Toll Free USA/Canada  
Email: orderlit@onsemi.com

**N. American Technical Support:** 800-282-9855 Toll Free  
USA/Canada  
**Europe, Middle East and Africa Technical Support:**  
Phone: 421 33 790 2910  
**Japan Customer Focus Center**  
Phone: 81-3-5817-1050

**ON Semiconductor Website:** [www.onsemi.com](http://www.onsemi.com)

**Order Literature:** <http://www.onsemi.com/orderlit>

For additional information, please contact your local Sales Representative



Компания «ЭлектроПласт» предлагает заключение долгосрочных отношений при поставках импортных электронных компонентов на взаимовыгодных условиях!

Наши преимущества:

- Оперативные поставки широкого спектра электронных компонентов отечественного и импортного производства напрямую от производителей и с крупнейших мировых складов;
- Поставка более 17-ти миллионов наименований электронных компонентов;
- Поставка сложных, дефицитных, либо снятых с производства позиций;
- Оперативные сроки поставки под заказ (от 5 рабочих дней);
- Экспресс доставка в любую точку России;
- Техническая поддержка проекта, помощь в подборе аналогов, поставка прототипов;
- Система менеджмента качества сертифицирована по Международному стандарту ISO 9001;
- Лицензия ФСБ на осуществление работ с использованием сведений, составляющих государственную тайну;
- Поставка специализированных компонентов (Xilinx, Altera, Analog Devices, Intersil, Interpoint, Microsemi, Aeroflex, Peregrine, Syfer, Eurofarad, Texas Instrument, Miteq, Cobham, E2V, MA-COM, Hittite, Mini-Circuits, General Dynamics и др.);

Помимо этого, одним из направлений компании «ЭлектроПласт» является направление «Источники питания». Мы предлагаем Вам помощь Конструкторского отдела:

- Подбор оптимального решения, техническое обоснование при выборе компонента;
- Подбор аналогов;
- Консультации по применению компонента;
- Поставка образцов и прототипов;
- Техническая поддержка проекта;
- Защита от снятия компонента с производства.



#### Как с нами связаться

**Телефон:** 8 (812) 309 58 32 (многоканальный)

**Факс:** 8 (812) 320-02-42

**Электронная почта:** [org@eplast1.ru](mailto:org@eplast1.ru)

**Адрес:** 198099, г. Санкт-Петербург, ул. Калинина, дом 2, корпус 4, литера А.