

## **SIOV metal oxide varistors**

Housed (ThermoFuse) varistors, AdvancedD series

**Series/Type:**        **ETFV25**

**Date:**                January 2018

© EPCOS AG 2018. Reproduction, publication and dissemination of this publication, enclosures hereto and the information contained therein without EPCOS' prior express consent is prohibited.

EPCOS AG is a TDK Group Company.

**Construction**

- Round varistor element, leaded
- Coating: epoxy resin, flame-retardant to UL 94 V-0
- Terminals: tinned copper wire, metal compound wire
- Housing: thermoplastic, flame-retardant to UL 94 V-0

**Features**

- Wide operating voltage range 115 ... 420 V<sub>RMS</sub>
- Self-protected under abnormal overvoltage conditions
- Very high surge current ratings of 20 kA

**Approvals**

- UL
- IEC
- VDE

**Applications**

- Air conditioner, refrigerator, TV, etc.
- Power meter, inverter, telecom equipment, etc.
- Transient voltage surge suppressors (TVSS)
- Solar inverter

**Delivery mode**

- Bulk (standard)

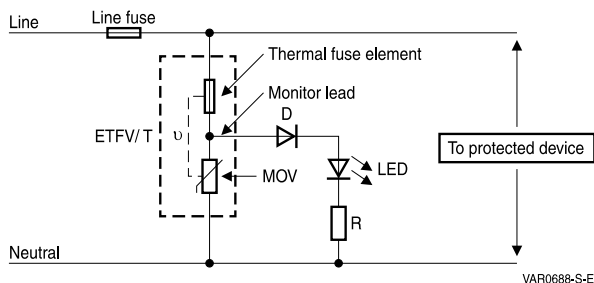
**Typical applications**

**General technical data**

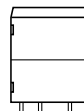
Climatic category	to IEC 60068-1	40/85/56	
Operating temperature	to IEC 61051	-40 ... + 85	°C
Storage temperature		-40 ... + 85	°C
Electric strength	to IEC 61051	≥ 2.5	kV <sub>RMS</sub>
Insulation resistance	to IEC 61051	≥ 100	MΩ

**Electrical specifications and ordering codes**
**Maximum ratings ( $T_A = 85\text{ }^\circ\text{C}$ )**

Ordering code	Type (untaped) SIOV-	$V_{RMS}$ V	$V_{DC}$ V	$i_{max}^{1)}$ (8/20 $\mu\text{s}$ ) A	$I_n^{2)}$ (8/20 $\mu\text{s}$ ) 15 times A	$W_{max}$ (2 ms) J	$P_{max}$ W
B72225T4111K101	ETFV25K115E4	115	150	20000	10000	170	1.0
B72225T4131K101	ETFV25K130E4	130	170	20000	10000	185	1.0
B72225T4141K101	ETFV25K140E4	140	180	20000	10000	195	1.0
B72225T4151K101	ETFV25K150E4	150	200	20000	10000	215	1.0
B72225T4171K101	ETFV25K175E4	175	225	20000	10000	245	1.0
B72225T4211K101	ETFV25K210E4	210	270	20000	10000	290	1.0
B72225T4231K101	ETFV25K230E4	230	300	20000	10000	315	1.0
B72225T4251K101	ETFV25K250E4	250	320	20000	10000	345	1.0
B72225T4271K101	ETFV25K275E4	275	350	20000	10000	375	1.0
B72225T4301K101	ETFV25K300E4	300	385	20000	10000	410	1.0
B72225T4321K101	ETFV25K320E4	320	420	20000	10000	445	1.0
B72225T4351K101	ETFV25K350E4	350	460	20000	10000	495	1.0
B72225T4381K101	ETFV25K385E4	385	505	20000	10000	600	1.0
B72225T4421K101	ETFV25K420E4	420	560	20000	10000	700	1.0

**Characteristics ( $T_A = 25\text{ }^\circ\text{C}$ )**

Ordering code	Type (untaped) SIOV-	$V_v$ (1 mA) V	$\Delta V_v$ (1 mA) %	$v_{c,max}$ ( $i_c$ ) V	$i_c$ A	$C_{typ}$ (1 kHz) pF
B72225T4111K101	ETFV25K115E4	180	$\pm 10$	300	150	2280
B72225T4131K101	ETFV25K130E4	205	$\pm 10$	340	150	2010
B72225T4141K101	ETFV25K140E4	220	$\pm 10$	360	150	1860
B72225T4151K101	ETFV25K150E4	240	$\pm 10$	395	150	1740
B72225T4171K101	ETFV25K175E4	270	$\pm 10$	455	150	1500
B72225T4211K101	ETFV25K210E4	330	$\pm 10$	545	150	1245
B72225T4231K101	ETFV25K230E4	360	$\pm 10$	595	150	1140
B72225T4251K101	ETFV25K250E4	390	$\pm 10$	650	150	1050
B72225T4271K101	ETFV25K275E4	430	$\pm 10$	710	150	945
B72225T4301K101	ETFV25K300E4	470	$\pm 10$	775	150	870
B72225T4321K101	ETFV25K320E4	510	$\pm 10$	840	150	810
B72225T4351K101	ETFV25K350E4	560	$\pm 10$	910	150	750
B72225T4381K101	ETFV25K385E4	620	$\pm 10$	1025	150	675
B72225T4421K101	ETFV25K420E4	680	$\pm 10$	1120	150	630

1) Note: Thermal fuse may form open circuit after 1 impulse @ 20 kA, 8/20  $\mu\text{s}$  test.

2) Note: Nominal discharge current  $I_n$ , according to UL 1449, 4<sup>th</sup> edition.

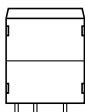

## Housed varistors

ETFV25

### ThermoFuse varistors, ETFV25 series

#### Dimensional drawings

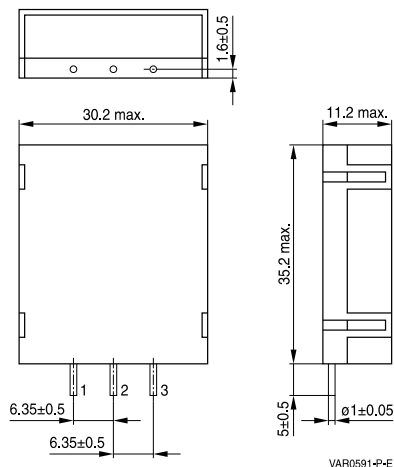

#### Weight

Nominal diameter mm	$V_{RMS}$ V	Weight g
25	115 ... 420	9.9 ... 18.6

#### Lead configuration

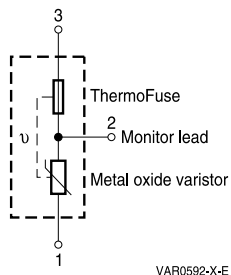

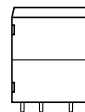

**Reliability data**

Test	Test methods/conditions	Requirement
Varistor voltage	The voltage between two terminals with the specified measuring current applied is called $V_V$ (1 mA <sub>DC</sub> @ 0.2 ... 2 s).	To meet the specified value
Clamping voltage	The maximum voltage between two terminals with the specified standard impulse current (8/20 $\mu$ s) applied.	To meet the specified value
Endurance at upper category temperature	1000 h at UCT After having continuously applied the maximum allowable AC voltage at UCT $\pm 2$ °C for 1000 h, the specimen shall be stored at room temperature and normal humidity for 1 to 2 h. Thereafter, the change of $V_V$ shall be measured.	$ \Delta V/V$ (1 mA)  $\leq 10\%$
Surge current derating, 8/20 $\mu$ s	10 surge currents (8/20 $\mu$ s), unipolar, interval 30 s, amplitude corresponding to derating curve for 10 impulses at 20 $\mu$ s	$ \Delta V/V$ (1 mA)  $\leq 10\%$ (measured in direction of surge current) No visible damage
Surge current derating, 2 ms	10 surge currents (2 ms), unipolar, interval 120 s, amplitude corresponding to derating curve for 10 impulses at 2 ms	$ \Delta V/V$ (1 mA)  $\leq 10\%$ (measured in direction of surge current) No visible damage
Electric strength	IEC 61051-1, test 4.9.2 Metal balls method, 2500 V <sub>RMS</sub> , 60 s The varistor is placed in a container holding 1.6 $\pm$ 0.2 mm diameter metal balls such that only the terminations of the varistor are protruding. The specified voltage shall be applied between both terminals of the specimen connected together and the electrode inserted between the metal balls.	No breakdown

**Housed varistors**
**ETFV25**
**ThermoFuse varistors, ETFV25 series**

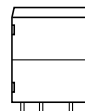
Test	Test methods/conditions	Requirement
Climatic sequence	<p>The specimen shall be subjected to:</p> <p>a) dry heat at UCT, 16 h, IEC 60068-2-2, test Ba</p> <p>b) damp heat, 1st cycle: 55 °C, 93% r. H., 24 h, IEC 60068-2-30, test Db</p> <p>c) cold, LCT, 2 h, IEC 60068-2-1, test Aa</p> <p>d) damp heat, additional 5 cycles: 55 °C/25 °C, 93% r. H., 24 h/cycle, IEC 60068-2-30, test Db.</p> <p>Then the specimen shall be stored at room temperature and normal humidity for 1 to 2 h.</p> <p>Thereafter, the change of <math>V_V</math> shall be measured. Thereafter, insulation resistance <math>R_{ins}</math> shall be measured at <math>V = 500</math> V.</p>	$ \Delta V/V (1 \text{ mA})  \leq 10\%$ $R_{ins} \geq 100 \text{ M}\Omega$
Rapid change of temperature	IEC 60068-2-14, test Na, LCT/UCT, dwell time 30 min, 5 cycles	$ \Delta V/V (1 \text{ mA})  \leq 5\%$ No visible damage
Damp heat, steady state	IEC 60068-2-78, test Ca  The specimen shall be subjected to $40 \pm 2$ °C, 90 to 95% r. H. for 56 days without load / with 10% of the maximum continuous DC operating voltage $V_{DC}$ . Then stored at room temperature and normal humidity for 1 to 2 h.  Thereafter, the change of $V_V$ shall be measured. Thereafter, insulation resistance $R_{ins}$ shall be measured at $V = 500$ V (insulated varistors only).	$ \Delta V/V (1 \text{ mA})  \leq 10\%$ $R_{ins} \geq 100 \text{ M}\Omega$

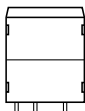

Test	Test methods/conditions	Requirement
Solderability	<p>IEC 60068-2-20, test Ta, method 1 with modified conditions for lead-free solder alloys: 245 °C, 3 s:</p> <p>After dipping the terminals to a depth of approximately 3 mm from the body in a soldering bath of 245 °C for 3 s, the terminals shall be visually examined.</p>	<p>The inspection shall be carried out under adequate light with normal eyesight or with the assistance of a magnifier capable of giving a magnification of 4 to 10 times. The dipped surface shall be covered with a smooth and bright solder coating with no more than small amounts of scattered imperfections such as pinholes or un-wetted or de-wetted areas. These imperfections shall not be concentrated in one area.</p>
Resistance to soldering heat	<p>IEC 60068-2-20, test Tb, method 1A, 260 °C, 10 s:</p> <p>Each lead shall be dipped into a solder bath having a temperature of 260 ±5 °C to a point 2.0 to 2.5 mm from the body of the specimen, be held there for 10 ±1 s and then be stored at room temperature and normal humidity for 1 to 2 h.</p> <p>The change of <math>V_V</math> shall be measured and the specimen shall be visually examined.</p>	<p><math> \Delta V/V (1 \text{ mA})  \leq 5\%</math></p> <p>No visible damage</p>
Tensile strength	<p>IEC 60068-2-21, test Ua1</p> <p>After gradually applying the force specified below and keeping the unit fixed for 10 s, the terminal shall be visually examined for any damage.</p> <p>Force for wire diameter:</p> <p>0.6 mm = 10 N 0.8 mm = 10 N 1.0 mm = 20 N</p>	<p><math> \Delta V/V (1 \text{ mA})  \leq 5\%</math></p> <p>No break of solder joint, no wire break</p>

**Housed varistors**
**ETFV25**
**ThermoFuse varistors, ETFV25 series**

Test	Test methods/conditions	Requirement
Vibration	IEC 60068-2-6, test Fc, method B4 Frequency range: 10 ... 55 Hz Amplitude: 0.75 mm or 98 m/s <sup>2</sup> Duration: 6 h (3 · 2 h) Pulse: sine wave After repeatedly applying a single harmonic vibration according to the table above. The change of V <sub>v</sub> shall be measured and the specimen shall be visually examined.	ΔV/V (1 mA)  ≤5% No visible damage
Bump	IEC 60068-2-29, test Eb Pulse duration: 6 ms Max. acceleration: 400 m/s <sup>2</sup> Number of bumps: 4000 Pulse: half sine	ΔV/V (1 mA)  ≤5% No visible damage
Fire hazard	IEC 60695-11-5 (needle flame test) Severity: vertical 10 s	5 s max.



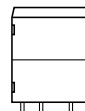

Test	Test methods/conditions	Requirement																																													
Abnormal overvoltage test	The device is designed to meet the limited current abnormal overvoltage condition, outlined in section 39.4 of UL 1449, 4 <sup>th</sup> edition. Detailed test voltage applied onto the device for different types as in the following table:	Any of these phenomena shall not be observed, or this specimen will be judged as failed part: <ol style="list-style-type: none"> <li>1. Emission of flame, molten metal, glowing or flaming particles through any openings (pre-existed or created as a result of the test) in the product.</li> <li>2. Charring, glowing, or flaming of the supporting surface, tissue paper, or cheesecloth.</li> <li>3. Ignition of the enclosure.</li> <li>4. Creation of any openings in the enclosure that result in accessibility of live parts, when evaluated in accordance with accessibility of live parts test in section 58.2 of UL1449, 4<sup>th</sup> edition.</li> </ol>																																													
	<table border="1"> <thead> <tr> <th>Type</th> <th>Device rating V</th> <th>Test voltage V</th> </tr> </thead> <tbody> <tr> <td>ETFV25K115E4</td> <td>115</td> <td>240</td> </tr> <tr> <td>ETFV25K130E4</td> <td>130</td> <td>260</td> </tr> <tr> <td>ETFV25K140E4</td> <td>140</td> <td>280</td> </tr> <tr> <td>ETFV25K150E4</td> <td>150</td> <td>300</td> </tr> <tr> <td>ETFV25K175E4</td> <td>175</td> <td>350</td> </tr> <tr> <td>ETFV25K210E4</td> <td>210</td> <td>420</td> </tr> <tr> <td>ETFV25K230E4</td> <td>230</td> <td>415</td> </tr> <tr> <td>ETFV25K250E4</td> <td>250</td> <td>500</td> </tr> <tr> <td>ETFV25K275E4</td> <td>275</td> <td>480</td> </tr> <tr> <td>ETFV25K300E4</td> <td>300</td> <td>600</td> </tr> <tr> <td>ETFV25K320E4</td> <td>320</td> <td>600</td> </tr> <tr> <td>ETFV25K350E4</td> <td>350</td> <td>600</td> </tr> <tr> <td>ETFV25K385E4</td> <td>385</td> <td>600</td> </tr> <tr> <td>ETFV25K420E4</td> <td>420</td> <td>600</td> </tr> </tbody> </table>		Type	Device rating V	Test voltage V	ETFV25K115E4	115	240	ETFV25K130E4	130	260	ETFV25K140E4	140	280	ETFV25K150E4	150	300	ETFV25K175E4	175	350	ETFV25K210E4	210	420	ETFV25K230E4	230	415	ETFV25K250E4	250	500	ETFV25K275E4	275	480	ETFV25K300E4	300	600	ETFV25K320E4	320	600	ETFV25K350E4	350	600	ETFV25K385E4	385	600	ETFV25K420E4	420	600
	Type		Device rating V	Test voltage V																																											
	ETFV25K115E4		115	240																																											
	ETFV25K130E4		130	260																																											
	ETFV25K140E4		140	280																																											
	ETFV25K150E4		150	300																																											
	ETFV25K175E4		175	350																																											
	ETFV25K210E4		210	420																																											
	ETFV25K230E4		230	415																																											
	ETFV25K250E4		250	500																																											
	ETFV25K275E4		275	480																																											
	ETFV25K300E4		300	600																																											
	ETFV25K320E4		320	600																																											
ETFV25K350E4	350	600																																													
ETFV25K385E4	385	600																																													
ETFV25K420E4	420	600																																													

**Note:**

UCT = Upper category temperature

LCT = Lower category temperature

 $R_{ins}$  = Insulation resistance

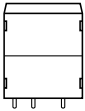

**Housed varistors**

**ETFV25**

**ThermoFuse varistors, ETFV25 series**

**v/i characteristics**

$v = f(i)$  for explanation of the characteristics refer to "General technical information", chapter 1.6.3  
 A = Leakage current, B = Protection level } for worst-case varistor tolerances

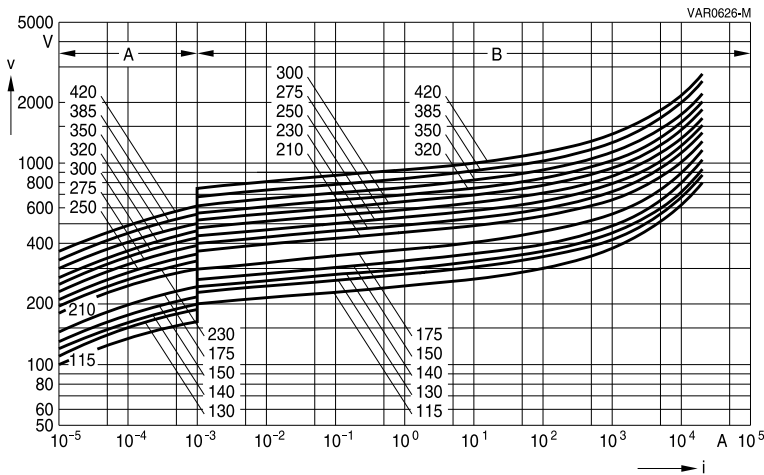

**SIOV-ETFV25 ... E4**

**Derating curves**

Maximum surge current  $i_{max} = f(t_r, \text{pulse train})$

For explanation of the derating curves refer to "General technical information", section 1.8.1

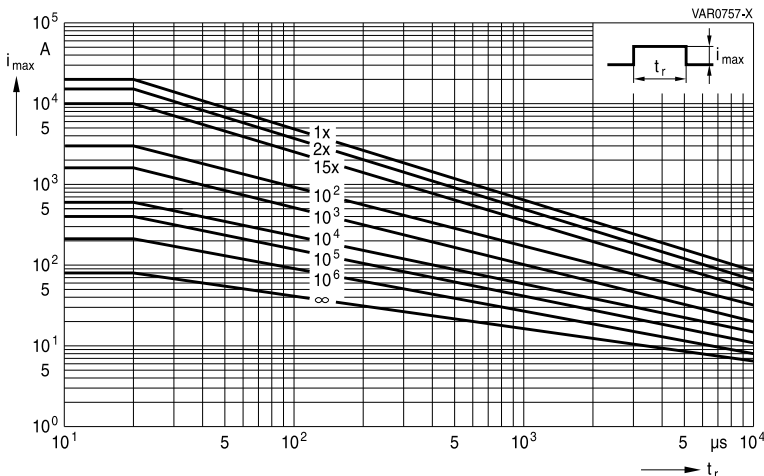

**SIOV-ETFV25 ... E4**

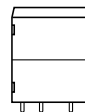

## Cautions and warnings

### General

1. EPCOS metal oxide varistors are designed for specific applications and should not be used for purposes not identified in our specifications, application notes and data books unless otherwise agreed with EPCOS during the design-in-phase.
2. Ensure suitability of SIOVs through reliability testing during the design-in phase. SIOVs should be evaluated taking into consideration worst-case conditions.
3. For applications of SIOVs in line-to-ground circuits based on various international and local standards there are restrictions existing or additional safety measures required.

### Storage

1. Store SIOVs only in original packaging. Do not open the package prior to processing.
2. Recommended storage conditions in original packaging:  
 Storage temperature:  $-25\text{ }^{\circ}\text{C} \dots +45\text{ }^{\circ}\text{C}$ ,  
 Relative humidity:  $<75\%$  annual average,  
 $<95\%$  on maximum 30 days a year.  
 Dew precipitation: is to be avoided.
3. Avoid contamination of an SIOV's during storage, handling and processing.
4. Avoid storage of SIOVs in harmful environments that can affect the function during long-term operation (examples given under operation precautions).
5. The SIOV type series should be soldered after shipment from EPCOS within the time specified:
 

SIOV-S, -Q, -LS, -B, -SNF	24 months
ETFV/ T series, -CU	12 months.

### Handling

1. SIOVs must not be dropped.
2. Components must not be touched with bare hands. Gloves are recommended.
3. Avoid contamination of the surface of SIOV electrodes during handling, be careful of the sharp edge of SIOV electrodes.

### Soldering (where applicable)

1. Use rosin-type flux or non-activated flux.
2. Insufficient preheating may cause ceramic cracks.
3. Rapid cooling by dipping in solvent is not recommended.
4. Complete removal of flux is recommended.
5. Temperatures of all preheat stages and the solder bath must be strictly controlled especially for T series (T14 and T20).

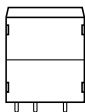

## Mounting

1. Potting, sealing or adhesive compounds can produce chemical reactions in the SIOV ceramic that will degrade the component's electrical characteristics.
2. Overloading SIOVs may result in ruptured packages and expulsion of hot materials. For this reason SIOVs should be physically shielded from adjacent components.

## Operation

1. Use SIOVs only within the specified temperature operating range.
2. Use SIOVs only within the specified voltage and current ranges.
3. Environmental conditions must not harm SIOVs. Use SIOVs only in normal atmospheric conditions. Avoid use in deoxidizing gases (chlorine gas, hydrogen sulfide gas, ammonia gas, sulfuric acid gas etc), corrosive agents, humid or salty conditions. Contact with any liquids and solvents should be prevented.

## Display of ordering codes for EPCOS products

The ordering code for one and the same EPCOS product can be represented differently in data sheets, data books, other publications, on the EPCOS website, or in order-related documents such as shipping notes, order confirmations and product labels. **The varying representations of the ordering codes are due to different processes employed and do not affect the specifications of the respective products.** Detailed information can be found on the Internet under [www.epcos.com/orderingcodes](http://www.epcos.com/orderingcodes)

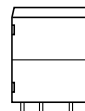
**Symbols and terms**

Symbol	Term
C	Capacitance
$C_{typ}$	Typical capacitance
i	Current
$i_c$	Current at which $V_{c, max}$ is measured
$I_{leak}$	Leakage current
$i_{max}$	Maximum surge current (also termed peak current)
$I_{max}$	Maximum discharge current
$I_n$	Nominal discharge current to UL 1449
LCT	Lower category temperature
$L_{typ}$	Typical inductance
$P_{max}$	Maximum average power dissipation
$R_{ins}$	Insulation resistance
$R_{min}$	Minimum resistance
$T_A$	Ambient temperature
$t_r$	Duration of equivalent rectangular wave
UCT	Upper category temperature
v	Voltage
$V_{clamp}$	Clamping voltage
$V_{c, max}$	Maximum clamping voltage at specified current $i_c$
$V_{DC}$	DC operating voltage
$V_{jump}$	Maximum jump start voltage
$V_{max}$	Maximum voltage
$V_{op}$	Operating voltage
$V_{RMS}$	AC operating voltage, root-mean-square value
$V_{RMS, op, max}$	Root-mean-square value of max. DC operating voltage incl. ripple current
$V_{surge}$	Super imposed surge voltage
$V_V$	Varistor voltage
$\Delta V_V$	Tolerance of varistor voltage
$W_{LD}$	Maximum load dump
$W_{max}$	Maximum energy absorption
$e$	Lead spacing

All dimensions are given in mm.

The commas used in numerical values denote decimal points.

## Important notes

The following applies to all products named in this publication:

1. Some parts of this publication contain **statements about the suitability of our products for certain areas of application**. These statements are based on our knowledge of typical requirements that are often placed on our products in the areas of application concerned. We nevertheless expressly point out **that such statements cannot be regarded as binding statements about the suitability of our products for a particular customer application**. As a rule we are either unfamiliar with individual customer applications or less familiar with them than the customers themselves. For these reasons, it is always ultimately incumbent on the customer to check and decide whether a product with the properties described in the product specification is suitable for use in a particular customer application.
2. We also point out that **in individual cases, a malfunction of electronic components or failure before the end of their usual service life cannot be completely ruled out in the current state of the art, even if they are operated as specified**. In customer applications requiring a very high level of operational safety and especially in customer applications in which the malfunction or failure of an electronic component could endanger human life or health (e.g. in accident prevention or life-saving systems), it must therefore be ensured by means of suitable design of the customer application or other action taken by the customer (e.g. installation of protective circuitry or redundancy) that no injury or damage is sustained by third parties in the event of malfunction or failure of an electronic component.
3. **The warnings, cautions and product-specific notes must be observed.**
4. In order to satisfy certain technical requirements, **some of the products described in this publication may contain substances subject to restrictions in certain jurisdictions (e.g. because they are classed as hazardous)**. Useful information on this will be found in our Material Data Sheets on the Internet ([www.tdk-electronics.tdk.com/material](http://www.tdk-electronics.tdk.com/material)). Should you have any more detailed questions, please contact our sales offices.
5. We constantly strive to improve our products. Consequently, **the products described in this publication may change from time to time**. The same is true of the corresponding product specifications. Please check therefore to what extent product descriptions and specifications contained in this publication are still applicable before or when you place an order.  
  
We also **reserve the right to discontinue production and delivery of products**. Consequently, we cannot guarantee that all products named in this publication will always be available. The aforementioned does not apply in the case of individual agreements deviating from the foregoing for customer-specific products.
6. Unless otherwise agreed in individual contracts, **all orders are subject to our General Terms and Conditions of Supply**.
7. **Our manufacturing sites serving the automotive business apply the IATF 16949 standard**. The IATF certifications confirm our compliance with requirements regarding the quality management system in the automotive industry. Referring to customer requirements and customer specific requirements ("CSR") TDK always has and will continue to have the policy of respecting individual agreements. Even if IATF 16949 may appear to support the acceptance of unilateral requirements, we hereby like to emphasize that **only requirements mutually agreed upon can and will be implemented in our Quality Management System**. For clarification purposes we like to point out that obligations from IATF 16949 shall only become legally binding if individually agreed upon.

## Important notes

8. The trade names EPCOS, CeraCharge, CeraDiode, CeraLink, CeraPad, CeraPlas, CSMP, CTVS, DeltaCap, DigiSiMic, ExoCore, FilterCap, FormFit, LeaXield, MiniBlue, MiniCell, MKD, MKK, MotorCap, PCC, PhaseCap, PhaseCube, PhaseMod, PhiCap, PowerHap, PQSine, PQvar, SIFERRIT, SIFI, SIKOREL, SilverCap, SIMDAD, SiMic, SIMID, SineFormer, SIOV, ThermoFuse, WindCap are **trademarks registered or pending** in Europe and in other countries. Further information will be found on the Internet at [www.tdk-electronics.tdk.com/trademarks](http://www.tdk-electronics.tdk.com/trademarks).

Release 2018-10

# Mouser Electronics

Authorized Distributor

Click to View Pricing, Inventory, Delivery & Lifecycle Information:

[EPCOS / TDK:](#)

[ETFV25K175E4](#) [ETFV25K420E4](#) [ETFV25K275E4](#) [ETFV25K320E4](#) [ETFV25K130E4](#) [ETFV25K150E4](#)





Компания «ЭлектроПласт» предлагает заключение долгосрочных отношений при поставках импортных электронных компонентов на взаимовыгодных условиях!

Наши преимущества:

- Оперативные поставки широкого спектра электронных компонентов отечественного и импортного производства напрямую от производителей и с крупнейших мировых складов;
- Поставка более 17-ти миллионов наименований электронных компонентов;
- Поставка сложных, дефицитных, либо снятых с производства позиций;
- Оперативные сроки поставки под заказ (от 5 рабочих дней);
- Экспресс доставка в любую точку России;
- Техническая поддержка проекта, помощь в подборе аналогов, поставка прототипов;
- Система менеджмента качества сертифицирована по Международному стандарту ISO 9001;
- Лицензия ФСБ на осуществление работ с использованием сведений, составляющих государственную тайну;
- Поставка специализированных компонентов (Xilinx, Altera, Analog Devices, Intersil, Interpoint, Microsemi, Aeroflex, Peregrine, Syfer, Eurofarad, Texas Instrument, Miteq, Cobham, E2V, MA-COM, Hittite, Mini-Circuits, General Dynamics и др.);

Помимо этого, одним из направлений компании «ЭлектроПласт» является направление «Источники питания». Мы предлагаем Вам помощь Конструкторского отдела:

- Подбор оптимального решения, техническое обоснование при выборе компонента;
- Подбор аналогов;
- Консультации по применению компонента;
- Поставка образцов и прототипов;
- Техническая поддержка проекта;
- Защита от снятия компонента с производства.



#### Как с нами связаться

**Телефон:** 8 (812) 309 58 32 (многоканальный)

**Факс:** 8 (812) 320-02-42

**Электронная почта:** [org@eplast1.ru](mailto:org@eplast1.ru)

**Адрес:** 198099, г. Санкт-Петербург, ул. Калинина, дом 2, корпус 4, литера А.