

Standard Recovery Diodes (Stud Version), 320 A



DO-205AB (DO-9)

FEATURES

- Diffused diode
- Wide current range
- High voltage ratings up to 1200 V
- High surge current capabilities
- Stud cathode and stud anode version
- Hermetic metal case
- Designed and qualified for industrial level
- Material categorization: for definitions of compliance please see www.vishay.com/doc?99912

RoHS
COMPLIANT

TYPICAL APPLICATIONS

- Welders
- Power supplies
- Machine tool controls
- High power drives
- Medium traction applications
- Battery charges
- Freewheeling diodes

PRODUCT SUMMARY

$I_{F(AV)}$	320 A
Package	DO-205AB (DO-9)
Circuit configuration	Single diode

MAJOR RATINGS AND CHARACTERISTICS

PARAMETER	TEST CONDITIONS	VALUES	UNITS
$I_{F(AV)}$		320	A
	T_C	100	°C
$I_{F(RMS)}$		500	A
I_{FSM}	50 Hz	4500	A
	60 Hz	4700	
I^2t	50 Hz	101	kA ² s
	60 Hz	92	
V_{RRM}	Range	600 to 1200	V
T_J		-40 to +180	°C

ELECTRICAL SPECIFICATIONS

VOLTAGE RATINGS

TYPE NUMBER	VOLTAGE CODE	V_{RRM} , MAXIMUM REPETITIVE PEAK REVERSE VOLTAGE V	V_{RSM} , MAXIMUM NON-REPETITIVE PEAK REVERSE VOLTAGE V	I_{RRM} MAXIMUM AT $T_J = T_J$ MAXIMUM mA
VS-240U(R)..	60	600	700	15
	80	800	900	
	100	1000	1100	
	120	1200	1300	



FORWARD CONDUCTION					
PARAMETER	SYMBOL	TEST CONDITIONS		VALUES	UNITS
Maximum average forward current at case temperature	$I_{F(AV)}$	180° conduction, half sine wave		320	A
				100	°C
Maximum RMS forward current	$I_{F(RMS)}$	DC at 80 °C case temperature		500	A
Maximum peak, one cycle forward, non-repetitive surge current	I_{FSM}	t = 10 ms	No voltage reapplied	4500	
		t = 8.3 ms	No voltage reapplied	4700	
		t = 10 ms	100 % V_{RRM} reapplied	3800	
		t = 8.3 ms	100 % V_{RRM} reapplied	4000	
Maximum I^2t for fusing	I^2t	t = 10 ms	No voltage reapplied	101	kA ² s
		t = 8.3 ms	No voltage reapplied	92	
		t = 10 ms	100 % V_{RRM} reapplied	72	
		t = 8.3 ms	100 % V_{RRM} reapplied	66	
Maximum $I^2\sqrt{t}$ for fusing	$I^2\sqrt{t}$	t = 0.1 to 10 ms, no voltage reapplied		1010	kA ² √s
Slope resistance	r_f	$T_J = T_J$ maximum		0.6	mΩ
Threshold voltage	$V_{F(T0)}$			0.83	V
Maximum forward voltage drop	V_{FM}	$I_{pk} = 750$ A, $T_J = 25$ °C, $t_p = 10$ ms sinusoidal wave		1.33	

THERMAL AND MECHANICAL SPECIFICATIONS					
PARAMETER	SYMBOL	TEST CONDITIONS		VALUES	UNITS
Maximum junction operating and storage temperature range	T_J, T_{Stg}			-40 to 180	°C
Maximum thermal resistance, junction to case	R_{thJC}	DC operation		0.18	K/W
Maximum thermal resistance, case to heatsink	R_{thCS}	Mounting surface, smooth, flat and greased		0.08	
Maximum allowable mounting torque +0 -20 %		Not lubricated threads		37 (330)	N · m (lbf · in)
		Lubricated threads		28 (250)	
Approximate weight				250	g
Case style		See dimensions - link at the end of datasheet		DO-205AB (DO-9)	

ΔR_{thJC} CONDUCTION				
CONDUCTION ANGLE	SINUSOIDAL CONDUCTION	RECTANGULAR CONDUCTION	TEST CONDITIONS	UNITS
180°	0.019	0.015	$T_J = T_J$ maximum	K/W
120°	0.023	0.025		
90°	0.030	0.034		
60°	0.045	0.047		
30°	0.076	0.076		

Note

- The table above shows the increment of thermal resistance R_{thJC} when devices operate at different conduction angles than DC

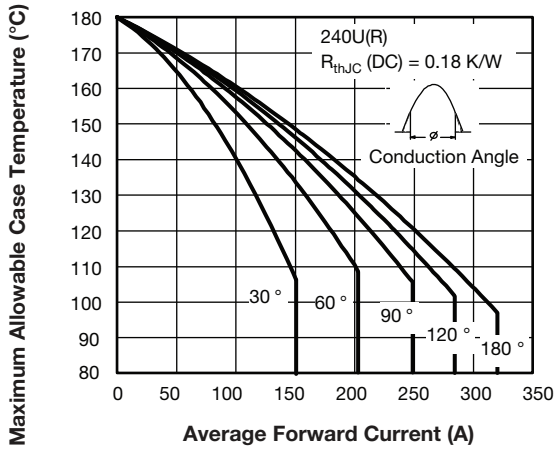

Fig. 1 - Current Ratings Characteristics

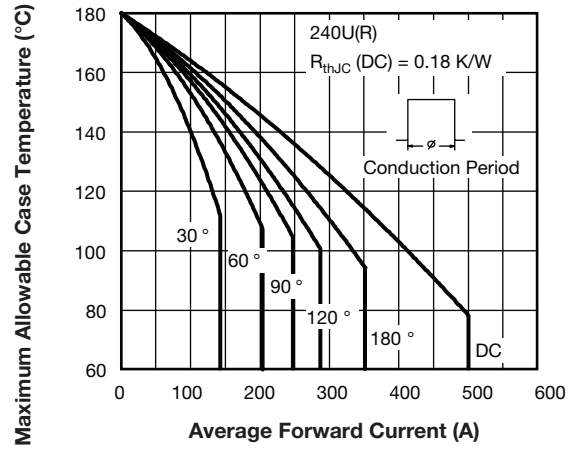

Fig. 2 - Current Ratings Characteristics

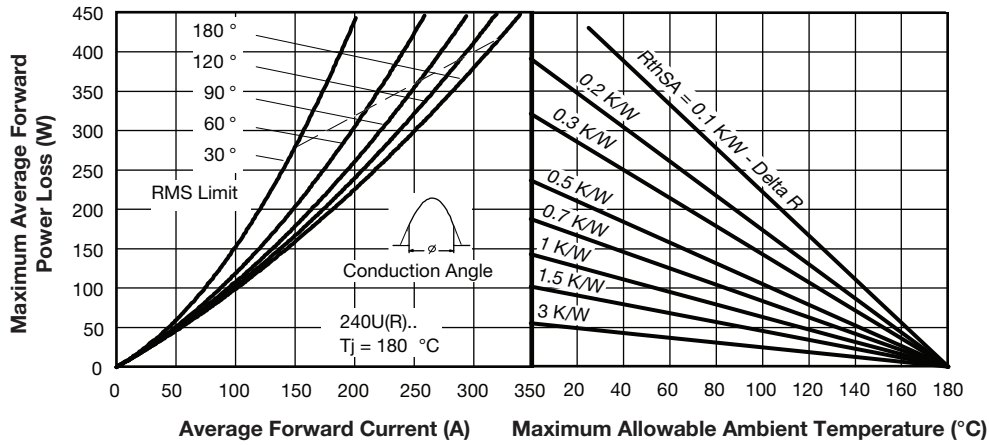

Fig. 3 - Forward Power Loss Characteristics

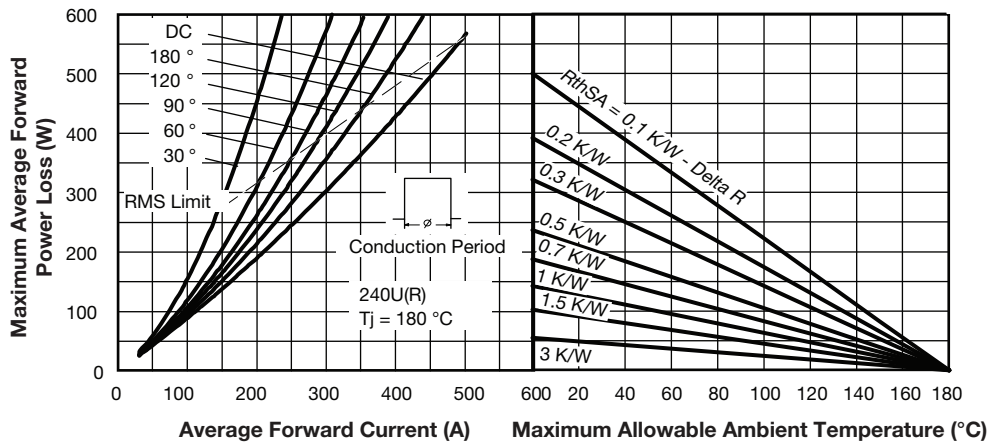

Fig. 4 - Forward Power Loss Characteristics

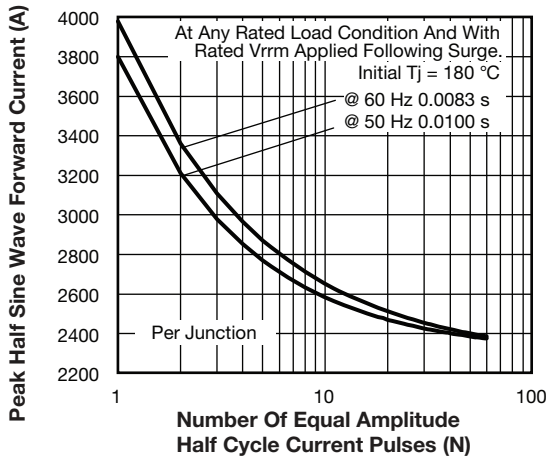

Fig. 5 - Maximum Non-Repetitive Surge Current

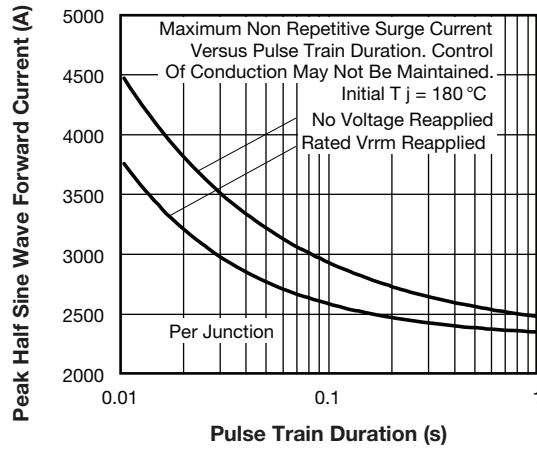

Fig. 6 - Maximum Non-Repetitive Surge Current

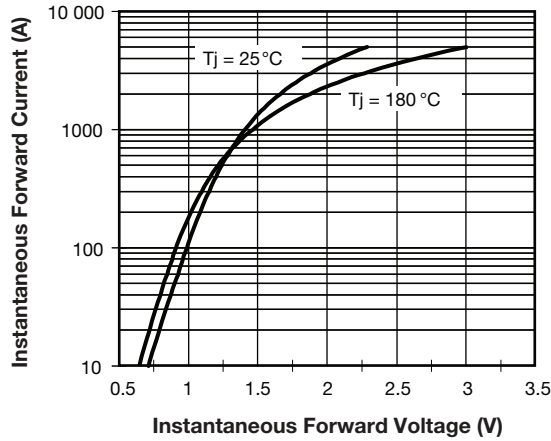

Fig. 7 - Forward Voltage Drop Characteristics

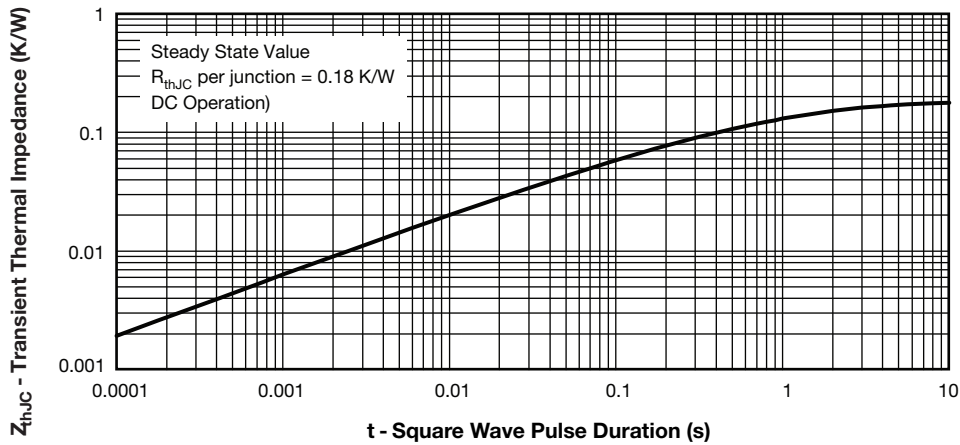
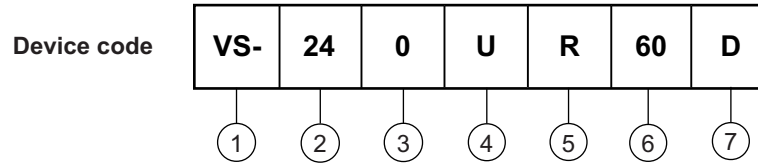

Fig. 8 - Thermal Impedance Z_{thJC} Characteristic



ORDERING INFORMATION TABLE



- 1** - Vishay Semiconductors product
- 2** - 24 = essential part number
- 3** - 0 = standard device
- 4** - U = stud normal polarity (cathode to stud)
- 5** -
 - None = stud normal polarity (cathode to stud)
 - R = stud reverse polarity (anode to stud)
- 6** - Voltage code x 10 = V_{RRM} (see Voltage Ratings table)
- 7** - Diffused diode

Note = For metric device M16 x 1.5 contact factory

LINKS TO RELATED DOCUMENTS	
Dimensions	www.vishay.com/doc?95317

DO-205AB (DO-9) for 240U(R) Series

DIMENSIONS in millimeters (inches)

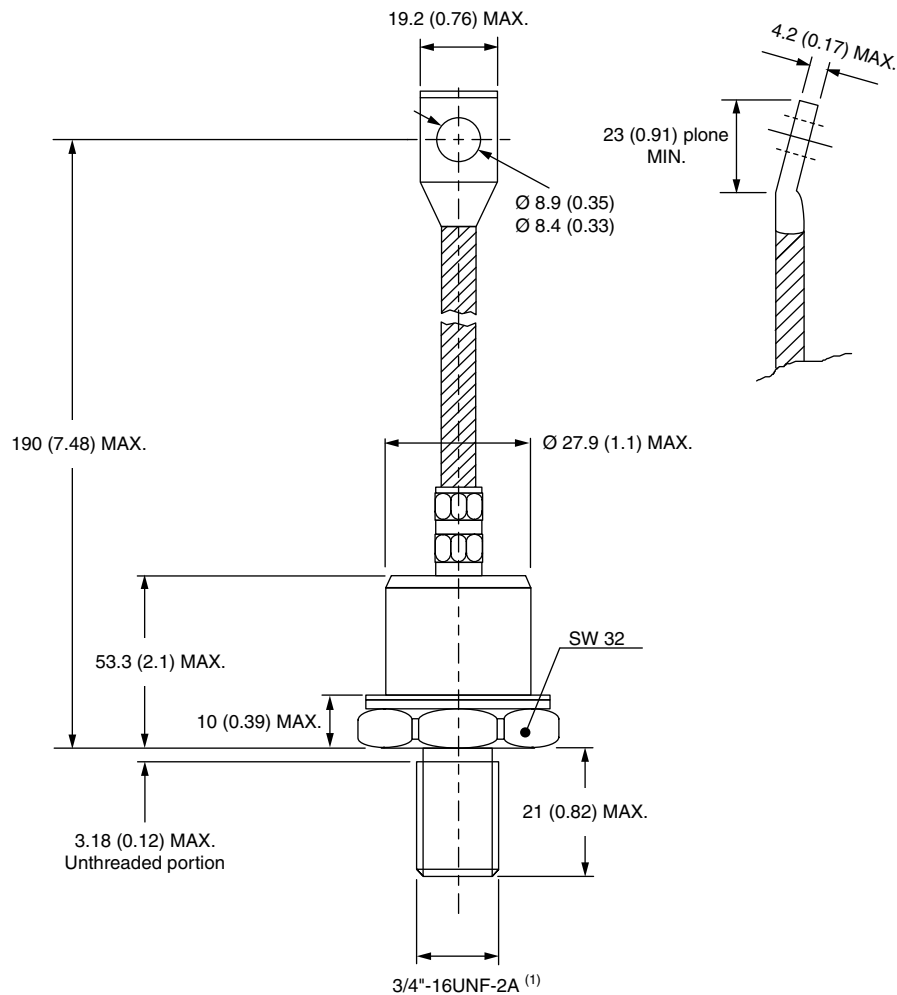

Note

⁽¹⁾ For metric device M16 x 1.5 contact factory



Disclaimer

ALL PRODUCT, PRODUCT SPECIFICATIONS AND DATA ARE SUBJECT TO CHANGE WITHOUT NOTICE TO IMPROVE RELIABILITY, FUNCTION OR DESIGN OR OTHERWISE.

Vishay Intertechnology, Inc., its affiliates, agents, and employees, and all persons acting on its or their behalf (collectively, "Vishay"), disclaim any and all liability for any errors, inaccuracies or incompleteness contained in any datasheet or in any other disclosure relating to any product.

Vishay makes no warranty, representation or guarantee regarding the suitability of the products for any particular purpose or the continuing production of any product. To the maximum extent permitted by applicable law, Vishay disclaims (i) any and all liability arising out of the application or use of any product, (ii) any and all liability, including without limitation special, consequential or incidental damages, and (iii) any and all implied warranties, including warranties of fitness for particular purpose, non-infringement and merchantability.

Statements regarding the suitability of products for certain types of applications are based on Vishay's knowledge of typical requirements that are often placed on Vishay products in generic applications. Such statements are not binding statements about the suitability of products for a particular application. It is the customer's responsibility to validate that a particular product with the properties described in the product specification is suitable for use in a particular application. Parameters provided in datasheets and/or specifications may vary in different applications and performance may vary over time. All operating parameters, including typical parameters, must be validated for each customer application by the customer's technical experts. Product specifications do not expand or otherwise modify Vishay's terms and conditions of purchase, including but not limited to the warranty expressed therein.

Except as expressly indicated in writing, Vishay products are not designed for use in medical, life-saving, or life-sustaining applications or for any other application in which the failure of the Vishay product could result in personal injury or death. Customers using or selling Vishay products not expressly indicated for use in such applications do so at their own risk. Please contact authorized Vishay personnel to obtain written terms and conditions regarding products designed for such applications.

No license, express or implied, by estoppel or otherwise, to any intellectual property rights is granted by this document or by any conduct of Vishay. Product names and markings noted herein may be trademarks of their respective owners.

Material Category Policy

Vishay Intertechnology, Inc. hereby certifies that all its products that are identified as RoHS-Compliant fulfill the definitions and restrictions defined under Directive 2011/65/EU of The European Parliament and of the Council of June 8, 2011 on the restriction of the use of certain hazardous substances in electrical and electronic equipment (EEE) - recast, unless otherwise specified as non-compliant.

Please note that some Vishay documentation may still make reference to RoHS Directive 2002/95/EC. We confirm that all the products identified as being compliant to Directive 2002/95/EC conform to Directive 2011/65/EU.

Vishay Intertechnology, Inc. hereby certifies that all its products that are identified as Halogen-Free follow Halogen-Free requirements as per JEDEC JS709A standards. Please note that some Vishay documentation may still make reference to the IEC 61249-2-21 definition. We confirm that all the products identified as being compliant to IEC 61249-2-21 conform to JEDEC JS709A standards.



Компания «ЭлектроПласт» предлагает заключение долгосрочных отношений при поставках импортных электронных компонентов на взаимовыгодных условиях!

Наши преимущества:

- Оперативные поставки широкого спектра электронных компонентов отечественного и импортного производства напрямую от производителей и с крупнейших мировых складов;
- Поставка более 17-ти миллионов наименований электронных компонентов;
- Поставка сложных, дефицитных, либо снятых с производства позиций;
- Оперативные сроки поставки под заказ (от 5 рабочих дней);
- Экспресс доставка в любую точку России;
- Техническая поддержка проекта, помощь в подборе аналогов, поставка прототипов;
- Система менеджмента качества сертифицирована по Международному стандарту ISO 9001;
- Лицензия ФСБ на осуществление работ с использованием сведений, составляющих государственную тайну;
- Поставка специализированных компонентов (Xilinx, Altera, Analog Devices, Intersil, Interpoint, Microsemi, Aeroflex, Peregrine, Syfer, Eurofarad, Texas Instrument, Miteq, Cobham, E2V, MA-COM, Hittite, Mini-Circuits, General Dynamics и др.);

Помимо этого, одним из направлений компании «ЭлектроПласт» является направление «Источники питания». Мы предлагаем Вам помощь Конструкторского отдела:

- Подбор оптимального решения, техническое обоснование при выборе компонента;
- Подбор аналогов;
- Консультации по применению компонента;
- Поставка образцов и прототипов;
- Техническая поддержка проекта;
- Защита от снятия компонента с производства.



Как с нами связаться

Телефон: 8 (812) 309 58 32 (многоканальный)

Факс: 8 (812) 320-02-42

Электронная почта: org@eplast1.ru

Адрес: 198099, г. Санкт-Петербург, ул. Калинина, дом 2, корпус 4, литера А.