



80x80x25 mm

San Ace 80L 9LG type

General Specifications

- Material Frame: Aluminum, Impeller: Plastic (Flammability: UL 94V-1)
- Expected life See the table below. (L10 life: 90% survival rate for continuous operation in free air at 60°C, rated voltage)
- Motor protection function Locked rotor burnout protection, Reverse polarity protection
For details, please refer to p. 547.
- Dielectric strength 50/60 Hz, 500 VAC, for 1 minute (between lead wire conductors and frame)
- Insulation resistance 10 MΩ or more with a 500 VDC megger (between lead wire conductors and frame)
- Sound pressure level (SPL) At 1 m away from the air inlet
- Storage temperature -30 to +70°C (Non-condensing)
- Lead wire ⊕Red ⊖Black (Sensor) Yellow (Control) Brown
(For models without PWM control function, there is no speed control wiring.)
- Mass 130 g

Specifications

The models listed below **have pulse sensors with PWM control function.**

Model no.	Rated voltage [V]	Operating voltage range [V]	PWM duty cycle* [%]	Rated current [A]	Rated input [W]	Rated speed [min ⁻¹]	Max. airflow [m ³ /min] [CFM]	Max. static pressure [Pa] [inchH ₂ O]	SPL [dB (A)]	Operating temperature [°C]	Expected life [h]	
9LG0812P4J001	12	10.8 to 13.2	100	0.6	7.2	7400	2.07 73.0	177 0.71	49	-20 to +70	180000/60°C	
			20	0.06	0.72	1800	0.5 17.6	10.4 0.04	16			
9LG0812P4G001			100	0.3	3.6	5500	1.54 54.3	98 0.39	43			
			25	0.05	0.6	1400	0.39 13.7	6.3 0.02	14			
9LG0812P4H001			100	0.12	1.44	3700	1.03 36.3	44 0.17	31			
			25	0.04	0.48	1100	0.3 10.5	3.9 0.01	13			
9LG0824P4J001		24	21.6 to 26.4	100	0.28	6.72	7400	2.07 73.0	177 0.71			49
				20	0.05	1.2	2400	0.67 23.6	18.6 0.07			22
9LG0824P4G001				100	0.14	3.36	5500	1.54 54.3	98 0.39			43
				20	0.02	0.48	1200	0.33 11.6	4.6 0.01			13
9LG0824P4H001				100	0.05	1.2	3700	1.03 36.3	44 0.17			31
				30	0.02	0.48	1100	0.3 10.5	3.9 0.01			13

* PWM frequency: 25 kHz. Fan does not rotate when PWM duty cycle is 0%.

The following sensor and control options are available for selection.

Available for all models. **Lock sensor**

Differs according to the model. Refer to the table on p. 576. **Without sensor** **Pulse sensor**

The models listed below **have pulse sensors.**

Model no.	Rated voltage [V]	Operating voltage range [V]	Rated current [A]	Rated input [W]	Rated speed [min ⁻¹]	Max. airflow [m ³ /min] [CFM]	Max. static pressure [Pa] [inchH ₂ O]	SPL [dB (A)]	Operating temperature [°C]	Expected life [h]		
9LG0812S4001	12	6 to 13.2	0.17	2.04	4200	1.17 41.3	56 0.22	35	-20 to +70	180000/60°C		
9LG0812F4001			0.1	1.2	3300	0.92 32.5	35 0.14	29				
9LG0812M4001			0.08	0.96	2900	0.8 28.3	27 0.11	25				
9LG0812L4001			0.06	0.72	2300	0.64 22.6	17 0.068	22				
9LG0824S4001		24	12 to 26.4	0.07	1.68	4200	1.17 41.3	56 0.22			35	
				9LG0824F4001	0.045	1.08	3300	0.92 32.5			35 0.14	29
				9LG0824M4001	0.04	0.96	2900	0.8 28.3			27 0.11	25
				9LG0824L4001	0.03	0.72	2300	0.64 22.6			17 0.068	22

The following sensor and control options are available for selection.

Available for all models. **Without sensor** **Lock sensor**

Airflow - Static Pressure Characteristics / PWM Duty - Speed Characteristics Example

9LG0812P4J001 With pulse sensor with PWM control function

PWM duty cycle

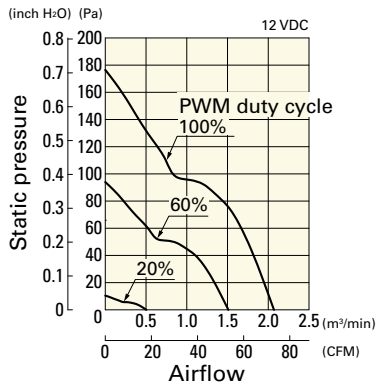

Operating voltage range

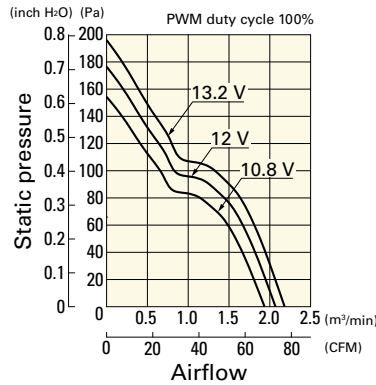

PWM duty - Speed characteristics example

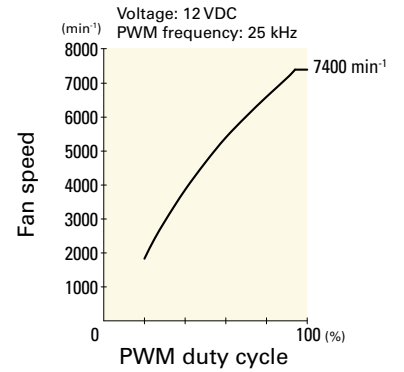

9LG0812P4G001 With pulse sensor with PWM control function

PWM duty cycle

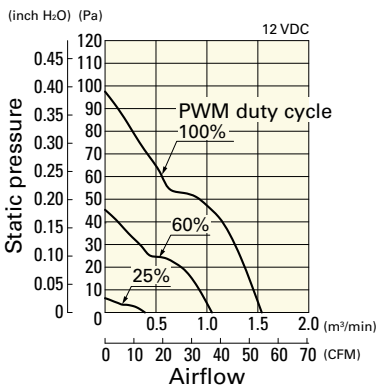

Operating voltage range

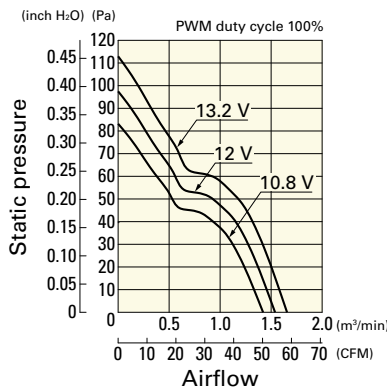

PWM duty - Speed characteristics example

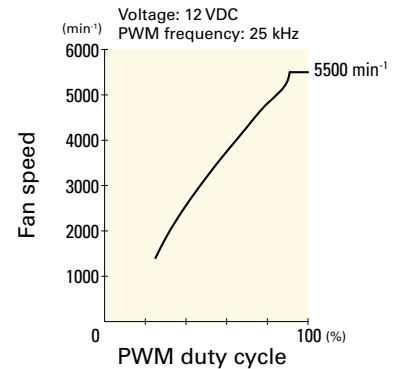

9LG0812P4H001 With pulse sensor with PWM control function

PWM duty cycle

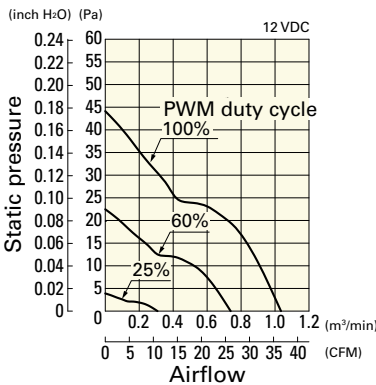

Operating voltage range

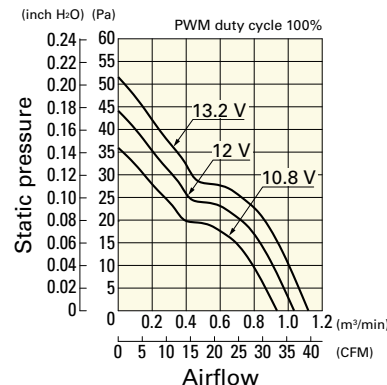

PWM duty - Speed characteristics example

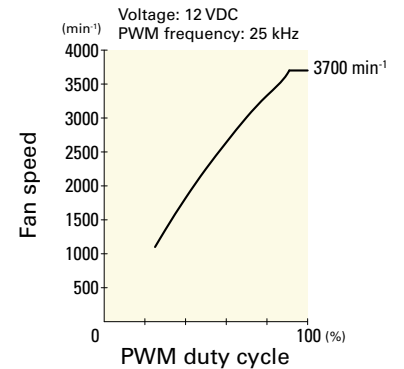

9LG0824P4J001 With pulse sensor with PWM control function

PWM duty cycle

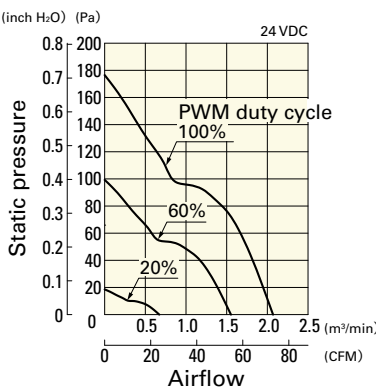

Operating voltage range

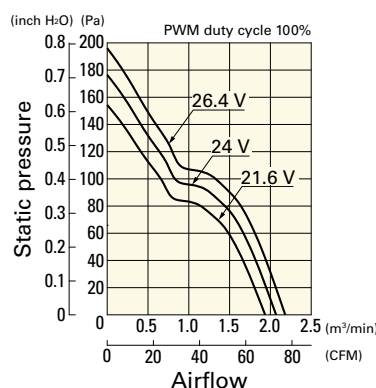

PWM duty - Speed characteristics example

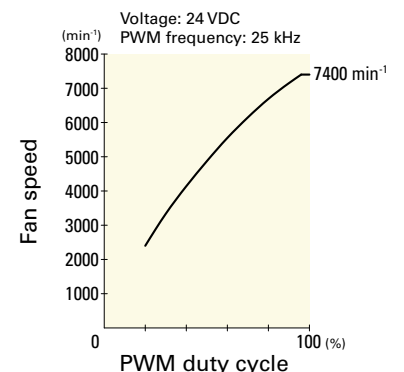

Airflow - Static Pressure Characteristics / PWM Duty - Speed Characteristics Example

9LG0824P4G001 With pulse sensor with PWM control function

PWM duty cycle

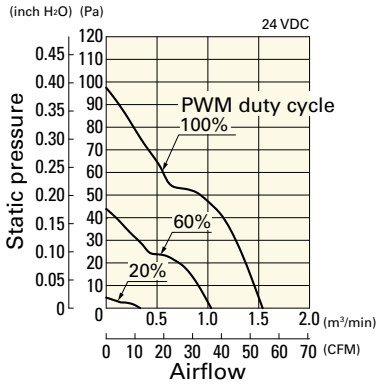

Operating voltage range

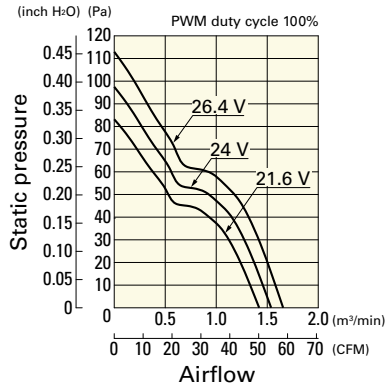

PWM duty - Speed characteristics example

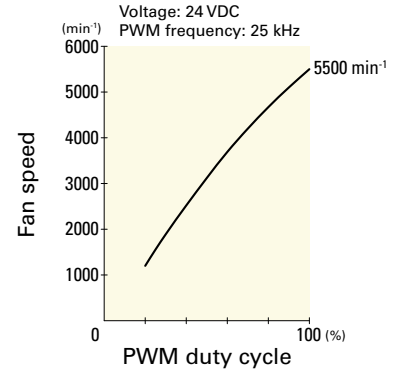

9LG0824P4H001 With pulse sensor with PWM control function

PWM duty cycle

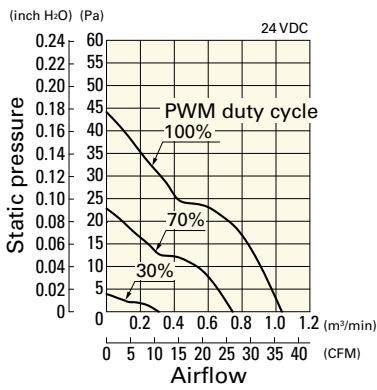

Operating voltage range

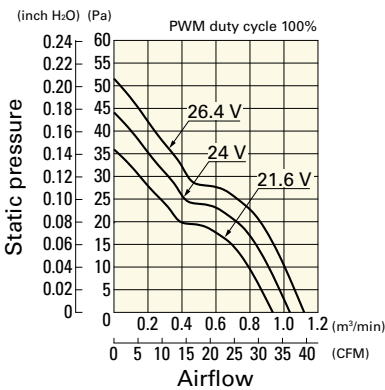

PWM duty - Speed characteristics example

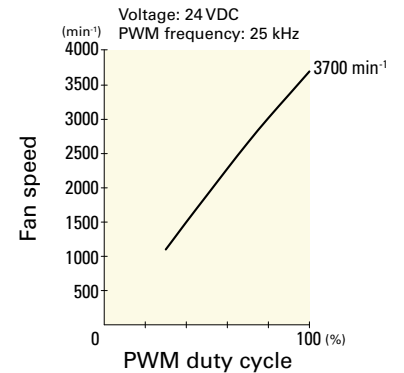

9LG0812S4001 With pulse sensor

Operating voltage range

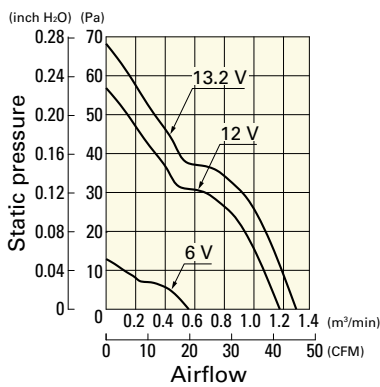

9LG0812F4001 With pulse sensor

Operating voltage range

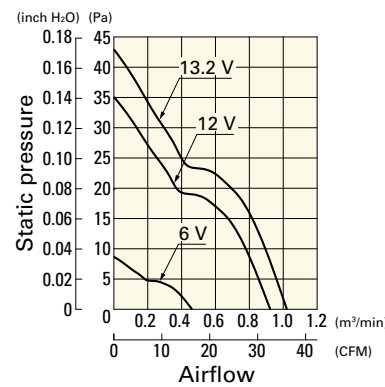

9LG0812M4001 With pulse sensor

Operating voltage range

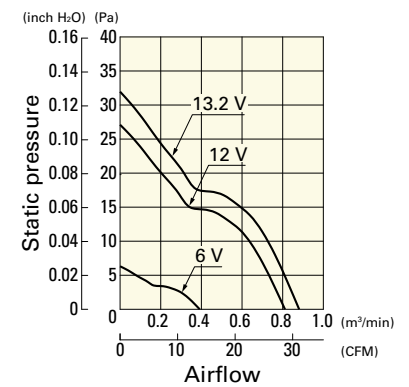

9LG0812L4001 With pulse sensor

Operating voltage range

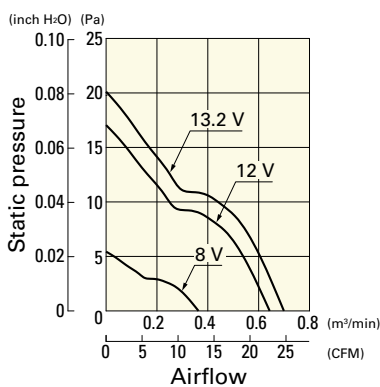

9LG0824S4001 With pulse sensor

Operating voltage range

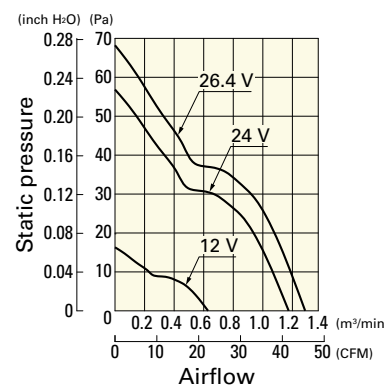

9LG0824F4001 With pulse sensor

Operating voltage range

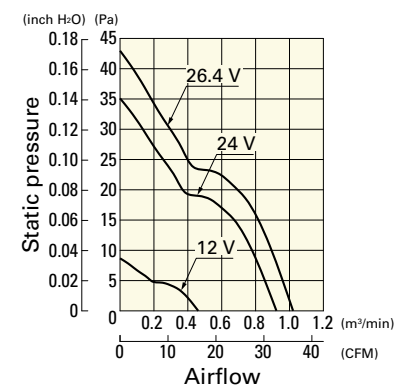

DC

Long Life Fan 80 mm sq.

Airflow - Static Pressure Characteristics

9LG0824M4001 With pulse sensor

Operating voltage range

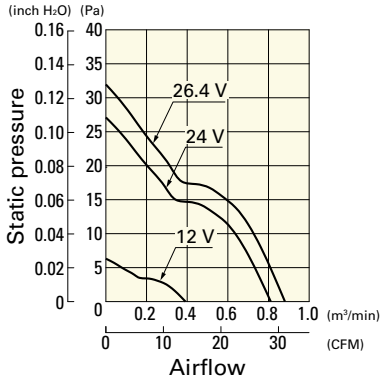

9LG0824L4001 With pulse sensor

Operating voltage range

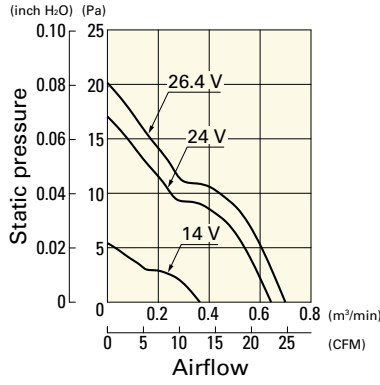

Dimensions (unit: mm)

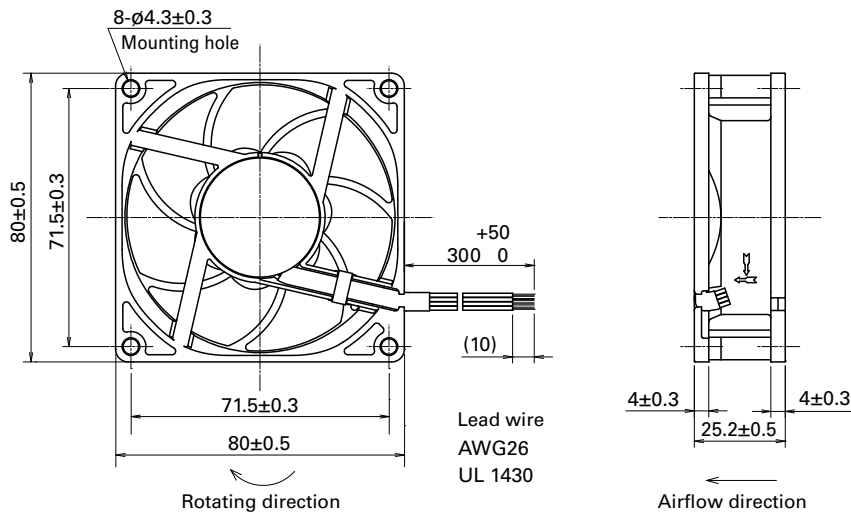

Reference Dimensions of Mounting Holes and Vent Opening (unit: mm)

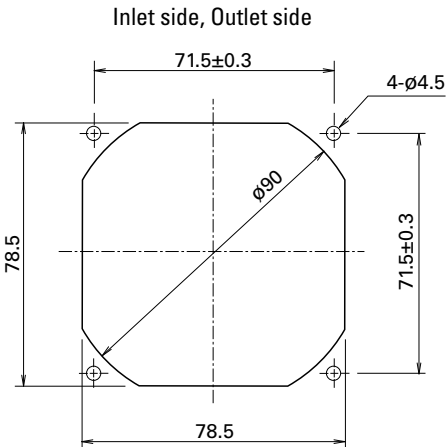

Options

Finger guards

page: p. 532

Model no.: 109-049E, 109-049H, 109-049C

Resin finger guards

page: p. 539

Model no.: 109-1002G

Resin filter kits

page: p. 540

Model no.: 109-1002F13 (13PPI), 109-1002F20 (20PPI),
109-1002F30 (30PPI), 109-1002F40 (40PPI)



Компания «ЭлектроПласт» предлагает заключение долгосрочных отношений при поставках импортных электронных компонентов на взаимовыгодных условиях!

Наши преимущества:

- Оперативные поставки широкого спектра электронных компонентов отечественного и импортного производства напрямую от производителей и с крупнейших мировых складов;
- Поставка более 17-ти миллионов наименований электронных компонентов;
- Поставка сложных, дефицитных, либо снятых с производства позиций;
- Оперативные сроки поставки под заказ (от 5 рабочих дней);
- Экспресс доставка в любую точку России;
- Техническая поддержка проекта, помощь в подборе аналогов, поставка прототипов;
- Система менеджмента качества сертифицирована по Международному стандарту ISO 9001;
- Лицензия ФСБ на осуществление работ с использованием сведений, составляющих государственную тайну;
- Поставка специализированных компонентов (Xilinx, Altera, Analog Devices, Intersil, Interpoint, Microsemi, Aeroflex, Peregrine, Syfer, Eurofarad, Texas Instrument, Miteq, Cobham, E2V, MA-COM, Hittite, Mini-Circuits, General Dynamics и др.);

Помимо этого, одним из направлений компании «ЭлектроПласт» является направление «Источники питания». Мы предлагаем Вам помощь Конструкторского отдела:

- Подбор оптимального решения, техническое обоснование при выборе компонента;
- Подбор аналогов;
- Консультации по применению компонента;
- Поставка образцов и прототипов;
- Техническая поддержка проекта;
- Защита от снятия компонента с производства.



Как с нами связаться

Телефон: 8 (812) 309 58 32 (многоканальный)

Факс: 8 (812) 320-02-42

Электронная почта: org@eplast1.ru

Адрес: 198099, г. Санкт-Петербург, ул. Калинина, дом 2, корпус 4, литера А.