



Features

- 5V Single Supply
- Excellent Linearity Performance at +34dBmV Output Power per Tone
- Two Amplifiers in Each SOIC-8 Package Simplify Push-Pull Configuration PC Board Layout
- Available in Lead-free, RoHS Compliant, and Green Packaging
- SOIC-8 Package

Applications

- CATV Head End Driver and Predriver Amplifier
- CATV Line Driver Amplifier

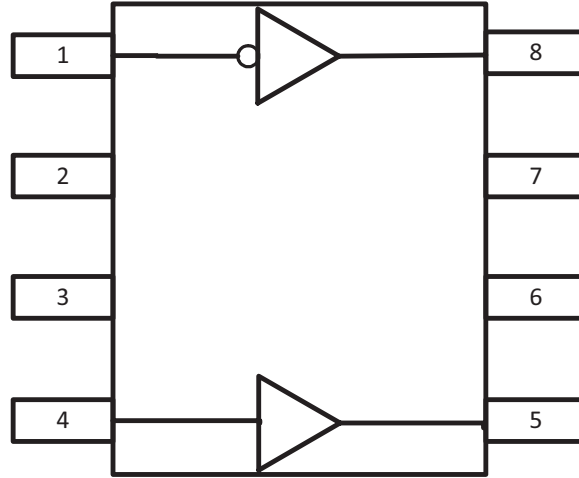

Functional Block Diagram

Product Description

RFMD's RFCA1008 is a high performance InGaP HBT MMIC amplifier designed with the InGaP process technology for excellent reliability. The heterojunction increases breakdown voltage and minimizes leakage current between junctions. A Darlington configuration is utilized for broadband performance. The RFCA1008 contains two amplifiers for use in wideband push-pull CATV amplifiers requiring excellent second order performance; the second and third order non-linearities are greatly improved in the push-pull configuration.

Ordering Information

| | |
|-----------------|--|
| RFCA1008SQ | 25 Piece sample bag |
| RFCA1008SR | 7" Sample reel with 100 pieces |
| RFCA1008TR13 | 13" Reel with 2500 pieces |
| RFCA1008PCK-410 | 50MHz to 1000MHz, PCBA with 5-piece sample bag |

Optimum Technology Matching® Applied

- | | | | |
|---|--------------------------------------|-------------------------------------|------------------------------------|
| <input type="checkbox"/> GaAs HBT | <input type="checkbox"/> SiGe BiCMOS | <input type="checkbox"/> GaAs pHEMT | <input type="checkbox"/> GaN HEMT |
| <input type="checkbox"/> GaAs MESFET | <input type="checkbox"/> Si BiCMOS | <input type="checkbox"/> Si CMOS | <input type="checkbox"/> BiFET HBT |
| <input checked="" type="checkbox"/> InGaP HBT | <input type="checkbox"/> SiGe HBT | <input type="checkbox"/> Si BJT | <input type="checkbox"/> SOI |

RF MICRO DEVICES®, RFMD®, Optimum Technology Matching®, Enabling Wireless Connectivity™, PowerStar®, POLARIS™ TOTAL RADIO™ and UltimateBlue™ are trademarks of RFMD, LLC. BLUETOOTH is a trademark owned by Bluetooth SIG, Inc., U.S.A. and licensed for use by RFMD. All other trade names, trademarks and registered trademarks are the property of their respective owners. ©2012, RF Micro Devices, Inc.

Absolute Maximum Ratings

| Parameter | Rating | Unit |
|---------------------------------------|-------------|------|
| Max Device Current (I_D) | 300 | mA |
| Max Device Voltage (V_D) | 6 | V |
| Max RF Input Power | 18 | dBm |
| Max Junction Temp (T_J) | 150 | °C |
| Operating Temperature Range (T_L) | -40 to +85 | °C |
| Storage Temperature | -40 to +150 | °C |

Notes:

1. Operation of this device beyond any one of these limits may cause permanent damage. For reliable continuous operation, the device voltage and current must not exceed the maximum operating values specified in the Absolute Maximum Ratings table above.
2. Bias Conditions should also satisfy the following expression:
 $I_D V_D < (T_J - T_L) / R_{TH, J - I}$ and $T_L = T_{LEAD}$



Caution! ESD sensitive device.

Exceeding any one or a combination of the Absolute Maximum Rating conditions may cause permanent damage to the device. Extended application of Absolute Maximum Rating conditions to the device may reduce device reliability. Specified typical performance or functional operation of the device under Absolute Maximum Rating conditions is not implied.

RoHS status based on EU Directive 2011/65/EU (at time of this document revision).

The information in this publication is believed to be accurate and reliable. However, no responsibility is assumed by RF Micro Devices, Inc. ("RFMD") for its use, nor for any infringement of patents, or other rights of third parties, resulting from its use. No license is granted by implication or otherwise under any patent or patent rights of RFMD. RFMD reserves the right to change component circuitry, recommended application circuitry and specifications at any time without prior notice.

Nominal Operating Parameters

| Parameter | Specification | | | Unit | Condition |
|--|---------------|------|------|------|---|
| | Min. | Typ. | Max. | | |
| | | | | | 17dB Application, $V_{CC} = 5V$, $I_{CC} = 215mA$ |
| Frequency Range | 50 | | 1000 | MHz | |
| Small Signal Gain | | 16.8 | | dB | 50MHz; 5V, 25 °C |
| | | 17.4 | | dB | 500MHz; 5V, 25 °C |
| | | 17.9 | | dB | 1000MHz; 5V, 25 °C |
| Gain Flatness | | ±0.5 | | dB | 50MHz to 1000MHz per ANSI/SCTE-144 2007 |
| Output IP3 | | 40 | | dBm | 550MHz, Tone Spacing = 6MHz, P_{OUT} per Tone = +5dBm |
| Output IP2 Plus | | 65 | | dBm | 550MHz, Tone Spacing = 30MHz P_{OUT} per Tone = 0dB |
| Output IP2 Minus | | 70 | | dBm | |
| P1dB | | 23 | | dBm | 500MHz |
| Input Return Loss | | 27 | | dB | |
| Output Return Loss | | 16 | | dB | |
| Noise Figure (Balun Insertion Loss Included) | | 4.0 | | dB | 50MHz to 1000MHz |
| CSO | | 80 | | dBc | 79 Channel, Flat Tilt, +34dBmV |
| CTB | | 76 | | dBc | |
| XMOD | | 69 | | dBc | |
| Device Operating Voltage | | 5.0 | | V | |
| Device Operating Current | | 215 | | mA | $V_{CC} = 5V$ |
| Thermal Resistance | | 40 | | °C/W | Junction to backside PCB under IC |

Note: $V_{CC} = 5V$, $I_C = 215mA$, $T_L = 25 °C$, $Z_S = Z_L = 75\Omega$, Push Pull Application Circuit

| Parameter | Specification | | | Unit | Condition |
|---|---------------|------|------|------|--|
| | Min. | Typ. | Max. | | |
| 15dB Application, V _{CC} = 5V, I _{CC} = 150mA | | | | | |
| Frequency Range | 50 | | 1000 | MHz | |
| Small Signal Gain | | 14.7 | | dB | 50MHz; 5V, 25 °C |
| | | 15.5 | | dB | 500MHz; 5V, 25 °C |
| | | 16.5 | | dB | 1000MHz; 5V, 25 °C |
| Gain Flatness | | ±0.5 | | dB | 50MHz to 1000MHz per ANSI/SCTE-144 2007 |
| Output IP3 | | 36 | | dBm | 550MHz, Tone Spacing = 6MHz, P _{OUT} per Tone = +5dBm |
| Output IP2 Plus | | 60 | | dBm | 550MHz, Tone Spacing = 30MHz P _{OUT} per Tone = 0dB |
| Output IP2 Minus | | 66 | | dBm | |
| P1dB | | 20 | | dBm | 500MHz |
| Input Return Loss | | 20 | | dB | |
| Output Return Loss | | 20 | | dB | |
| Noise Figure (Balun Insertion Loss Included) | | 4.5 | | dB | 50MHz to 1000MHz |
| CSO | | 77 | | dBc | 79 Channel, Flat Tilt, +34dBmV |
| CTB | | 70 | | dBc | |
| XMOD | | 61 | | dBc | |
| Device Operating Voltage | | 5.0 | | V | |
| Device Operating Current | | 150 | | mA | V _{CC} = 5V |
| Thermal Resistance | | 40 | | °C/W | Junction to backside PCB under IC |
| 17dB Application, V _{CC} = 5V, I _{CC} = 217mA | | | | | |
| Frequency Range | 5 | | 300 | MHz | |
| Small Signal Gain | | 17.4 | | dB | 150MHz; 5V, 25 °C |
| Gain Flatness | | ±0.2 | | dB | 5MHz to 300MHz, 25 °C per ANSI/SCTE-144 2007 |
| Output IP3 | | 41 | | dBm | 5MHz to 300MHz, Tone Spacing = 6MHz, P _{OUT} per Tone = +5dBm |
| Output IP2 Plus | | 73 | | dBm | 150MHz, Tone Spacing = 6MHz P _{OUT} per Tone = 0dB |
| Output IP2 Minus | | 73 | | dBm | |
| P1dB | | 22 | | dBm | 5MHz to 300MHz |
| Input Return Loss | | 22 | 16 | dB | |
| Output Return Loss | | 22 | 14 | dB | |
| Noise Figure (Balun Insertion Loss Included) | | 4.0 | | dB | 5MHz to 210MHz |
| CSO | | 80 | | dBc | 7 Channel, Flat Tilt, +50dBmV |
| CTB | | 67 | | dBc | |
| XMOD | | 66 | | dBc | |
| Device Operating Voltage | | 5.0 | | V | |
| Device Operating Current | | 217 | | mA | V _{CC} = 5V |
| Thermal Resistance | | 40 | | °C/W | Junction to backside PCB under IC |

Performance 17dB Application Circuit $V_{CC} = 5V$, $I_{CC} = 215mA$

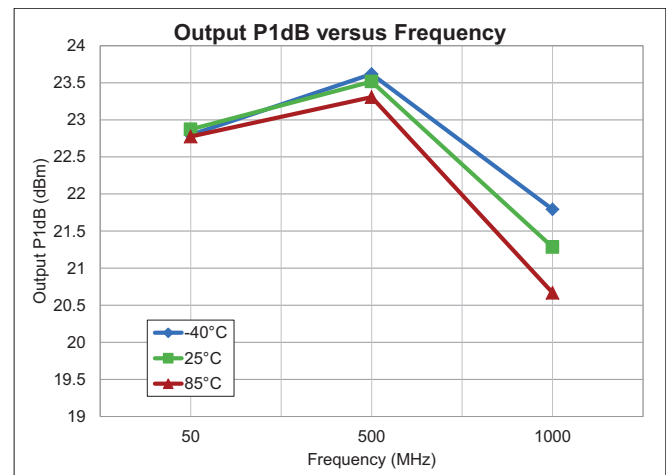
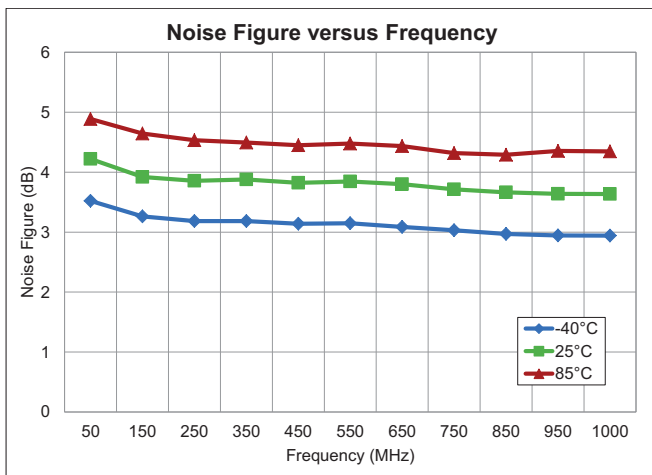
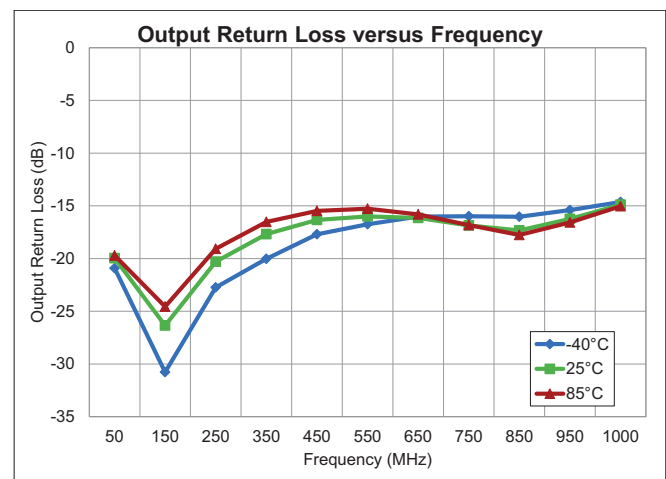
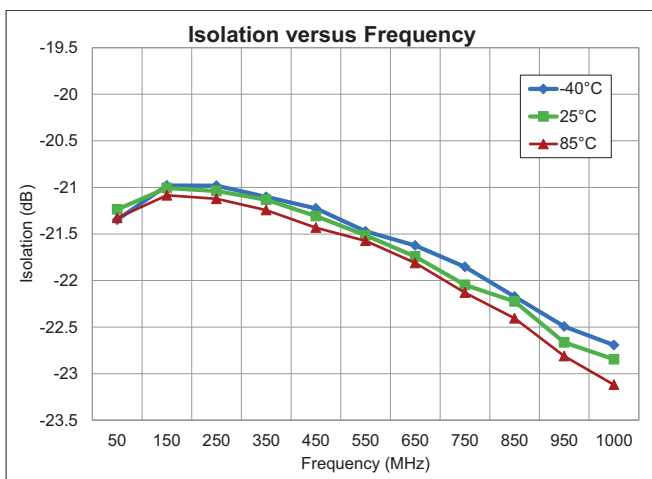
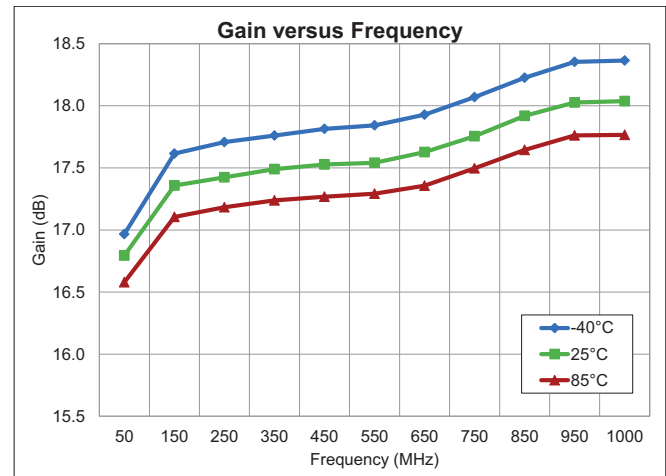

Performance 17dB Application Circuit $V_{CC} = 5V, I_{CC} = 215mA$

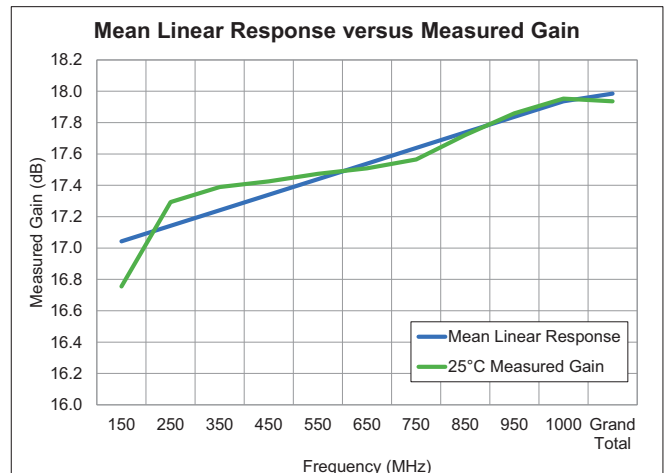
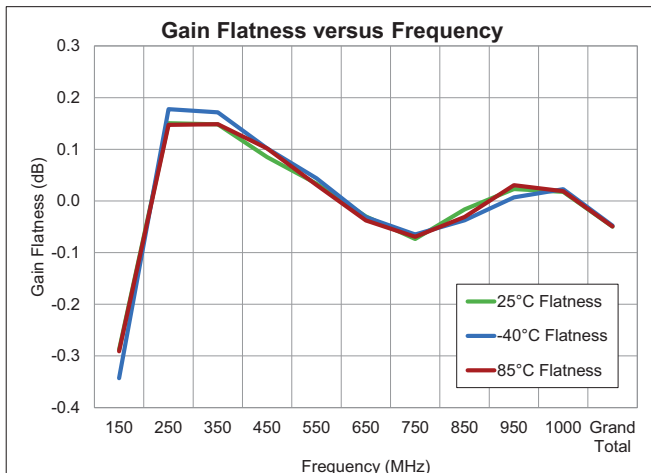
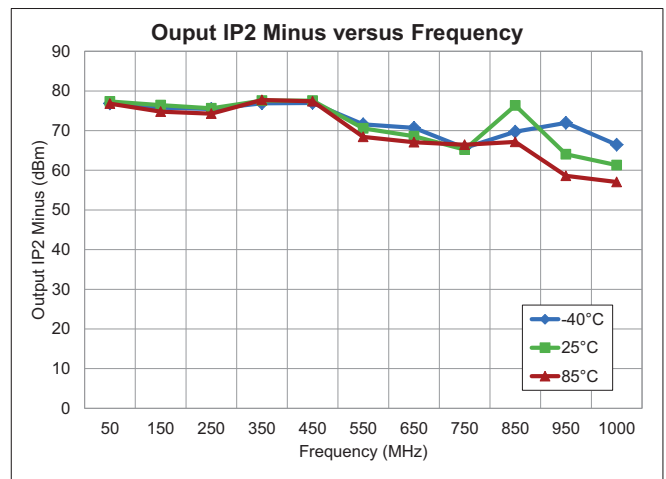
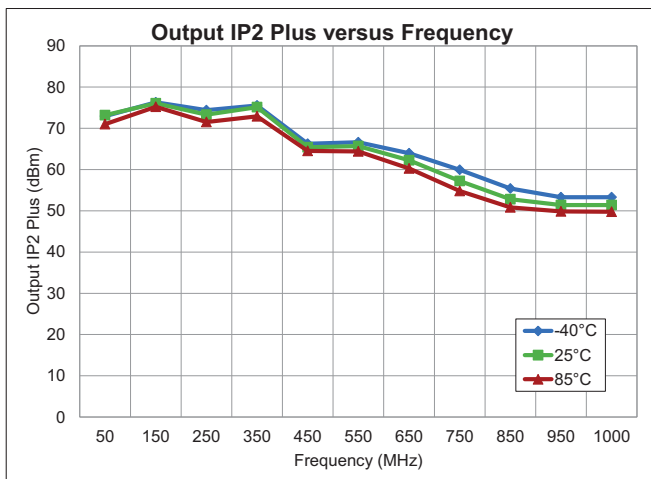
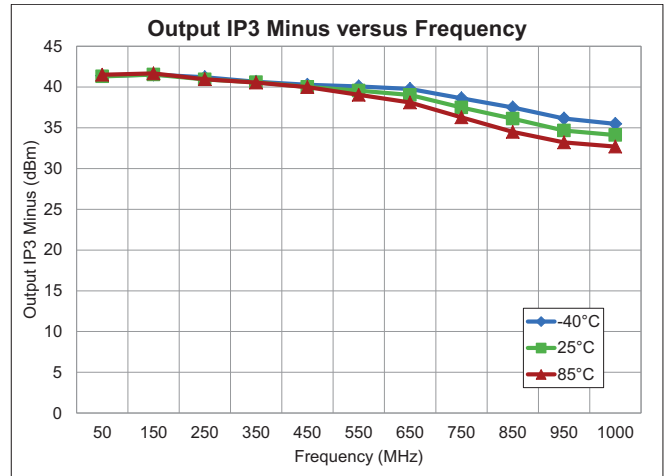
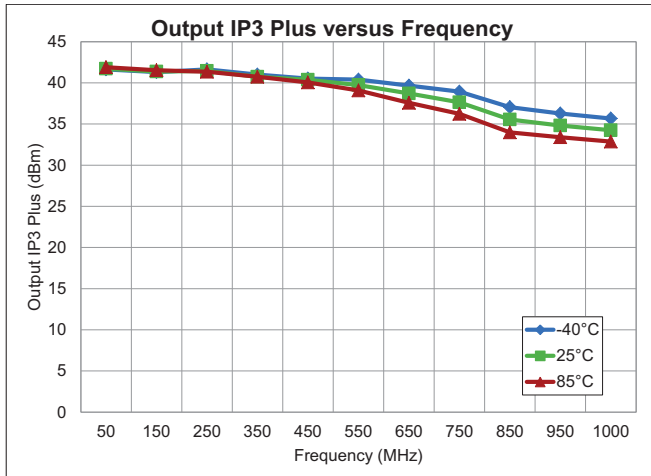

Performance 17dB Application Circuit $V_{CC} = 5V$, $I_{CC} = 215mA$

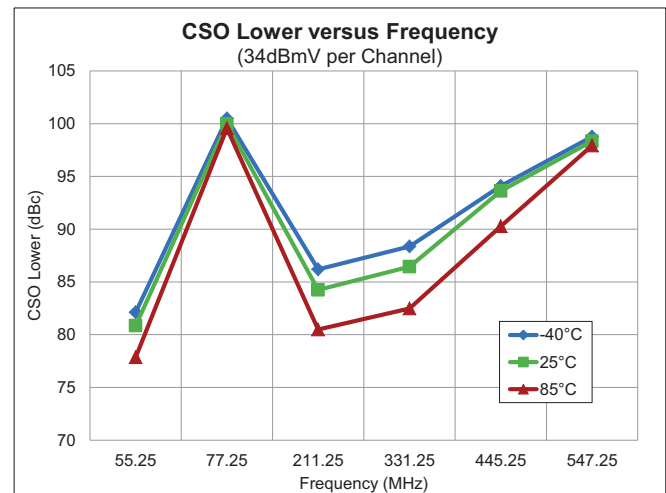
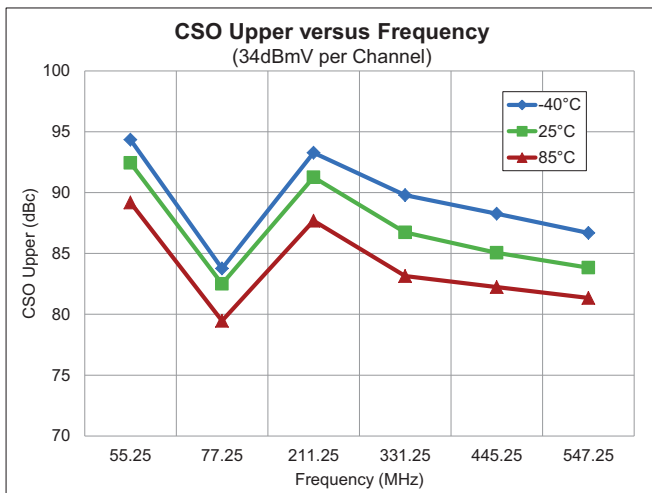
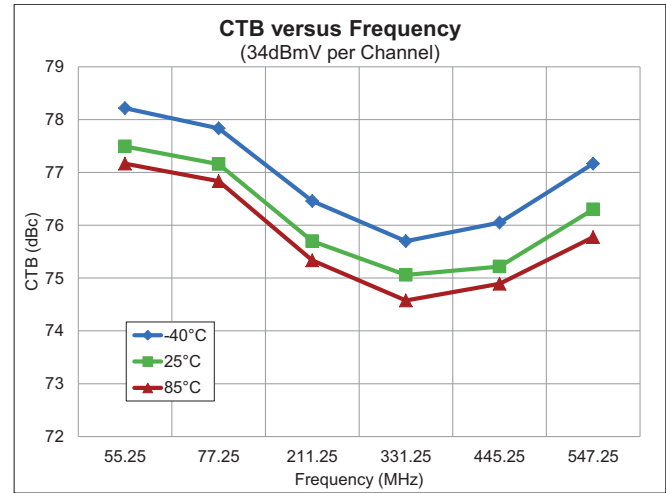
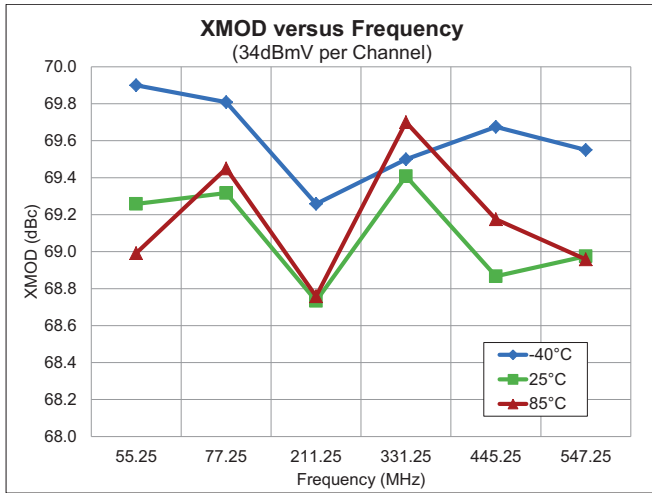

Evaluation Board Schematic
(17dB, 50MHz to 1000MHz Application Circuit)

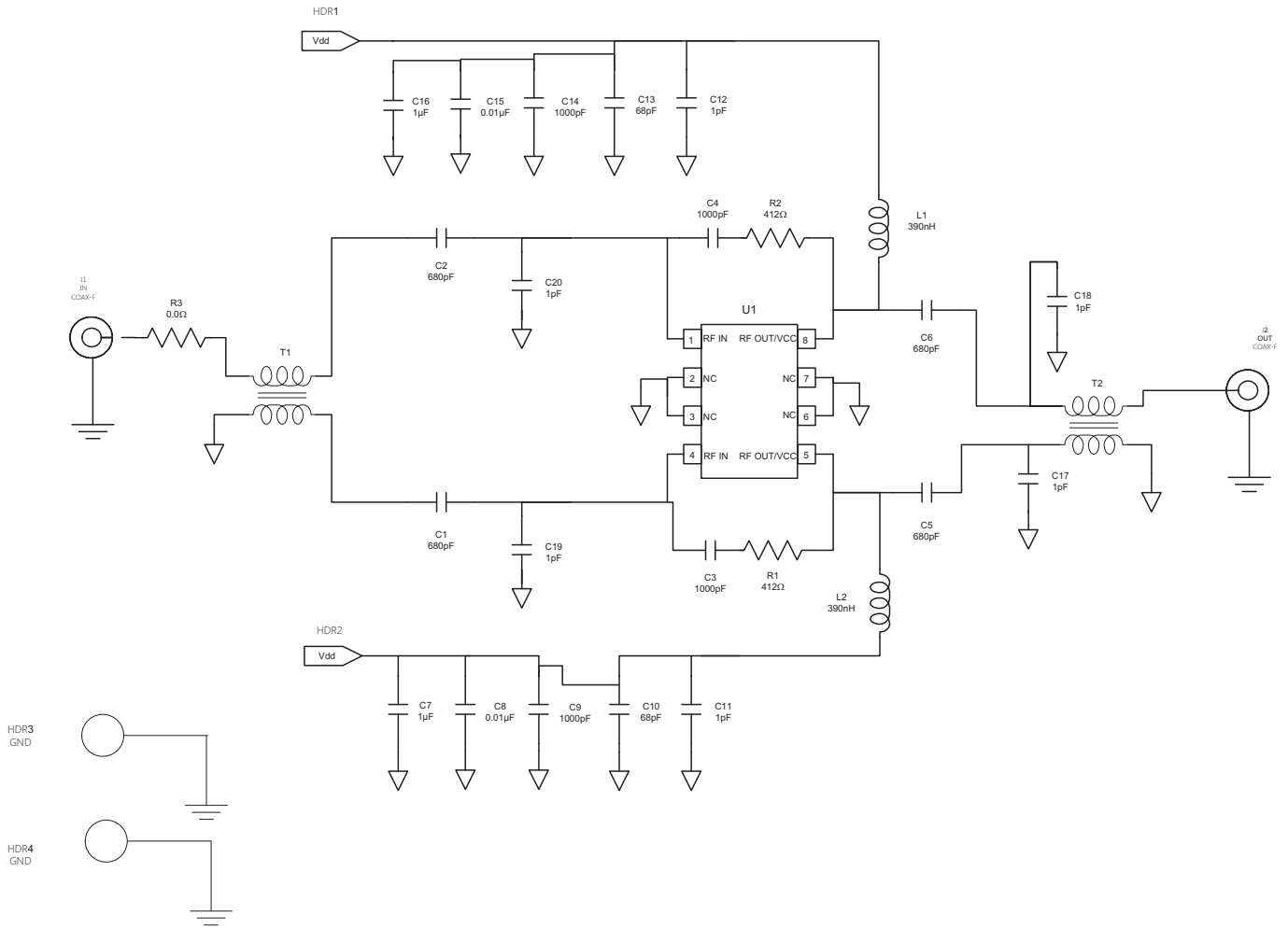

Evaluation Board Bill of Materials (BOM) (17dB, 50MHz to 1000MHz Application Circuit)

| Description | Reference Designator | Manufacturer | Manufacturer's P/N |
|---|----------------------|--------------------------|--------------------|
| PCB, DEMO, 31MIL BALANCED SOIC-8 CATV GA | | DDI | 225107(B) |
| DUAL CATV 5MHz to 1000MHz HI LIN GaAs HBT | U1 | RFMD | RFCA1008 |
| CAP, 1pF, +/-0.25pF, 50V, CG, 0402 | C19-C20 | Taiyo Yuden (USA), Inc. | RM UMK105CG010CW-F |
| CAP, 1000pF, 10%, 50V, X7R, 0402 | C3-C4 | Murata Electronics | GRM155R71H102KA01E |
| CAP, 1pF, +/-0.25pF, 50V, COG, 0603 | C11-C12, C17-C18 | Murata Electronics | GRM1885C1H1R0CZ01D |
| CAP, 68pF, 5%, 50V, COG, 0603 | C10, C13 | Murata Electronics | GRM1885C1H680JA01D |
| CAP, 680pF, 10%, 50V, X7R, 0603 | C1-C2, C5-C6 | Murata Electronics | GRM188R71H681KA01D |
| CAP, 1000pF, 10%, 50V, X7R, 0603 | C9, C14 | Murata Electronics | GRM188R71H102KA01D |
| CAP, 10000pF, 10%, 50V, X7R, 0603 | C8, C15 | Murata Electronics | GRM188R71H103KA01D |
| CAP, 1μF, 10%, 10V, X5R, 0603 | C7, C16 | Murata Electronics | GRM188R61A105KA61D |
| RES, 0Ω, 0402 | R3 | Panasonic | ERJ-2GE0R00 |
| RES, 412Ω, 1%, 1/16W, 0402 | R1-R2 | Panasonic | ERJ-2RKF4120X |
| IND, 390nH, 5%, W/W, 1008 | L1-L2 | Coilcraft | 1008CS-391XJBC |
| TRANSFORMER, S03, 5MHz to 1000MHz, 1:1, UNBAL | T1-T2 | MiniRF | XFM-1002-1UH |
| CONN, HDR, ST, 1-PIN, 0.100" | JP1-JP4 | Sullins | PEC01SAAN |
| CONN, F, EDGE MOUNT, 30 MIL | J1-J2 | Trompeter | CBJE130-2 |
| HEATSINK BLOCK, 1.5 X 2.0 IN | | | |
| SCREW, 2-56 x 3/16", SOCKET HEAD | | McMaster-Carr Supply Co. | 92196A076 |

Evaluation Board Assembly Drawing
(17dB, 50MHz to 1000MHz Application Circuit)

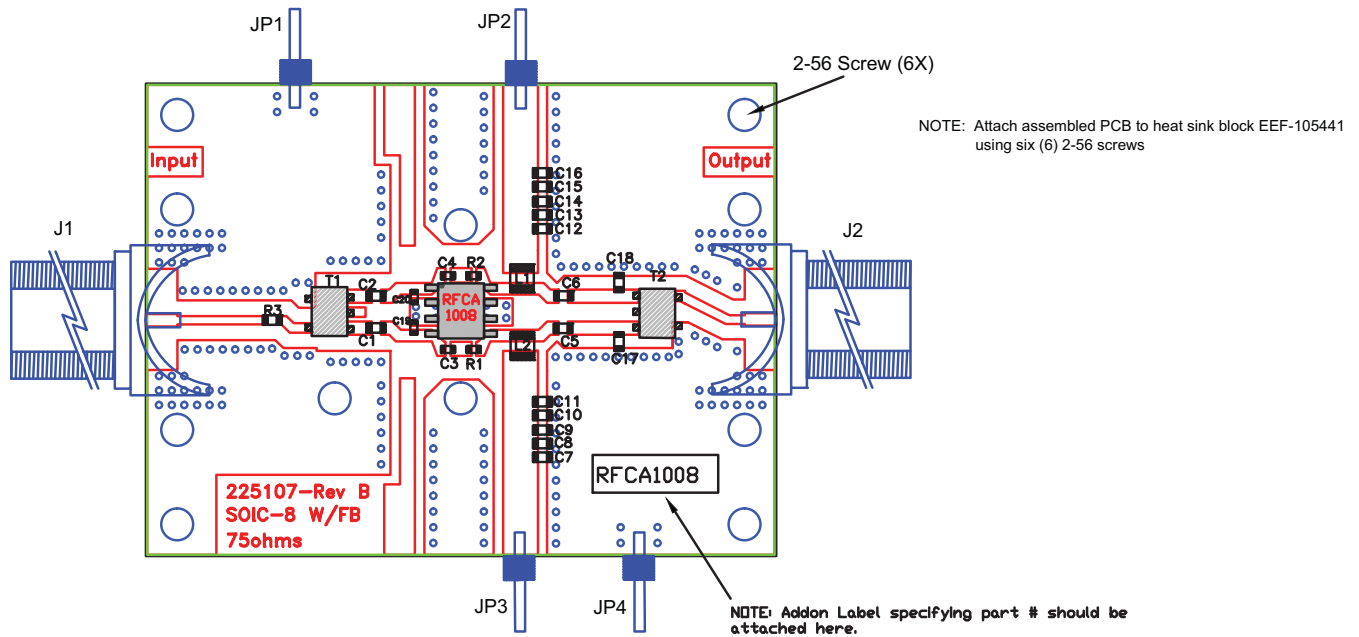

Performance 15dB Application Circuit $V_{CC} = 5V$, $I_{CC} = 150mA$

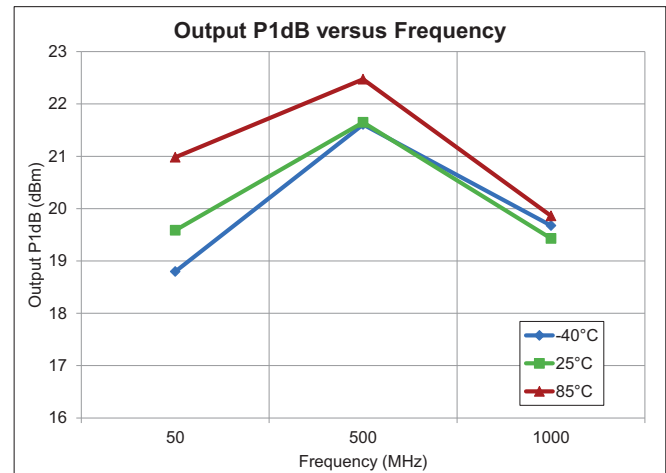
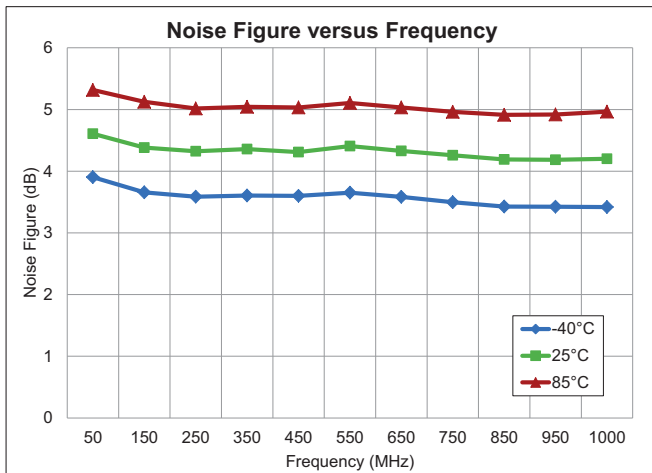
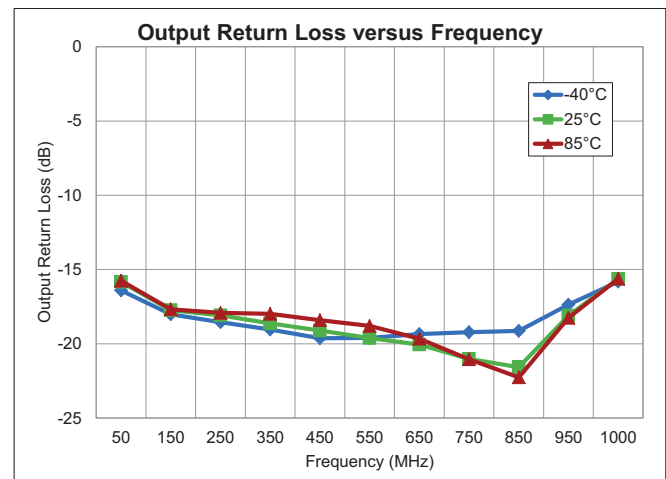
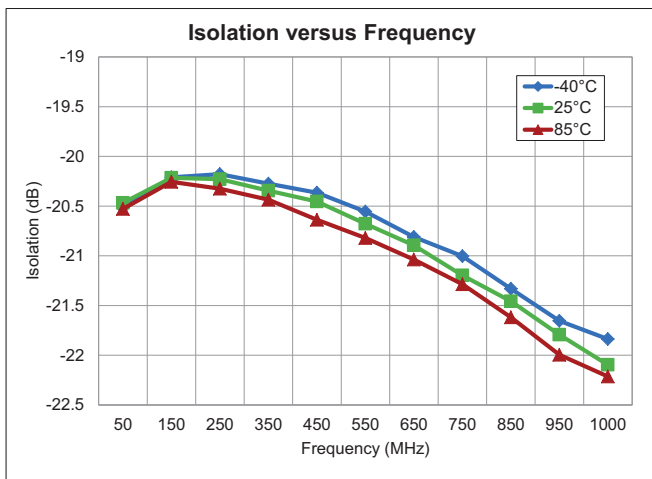
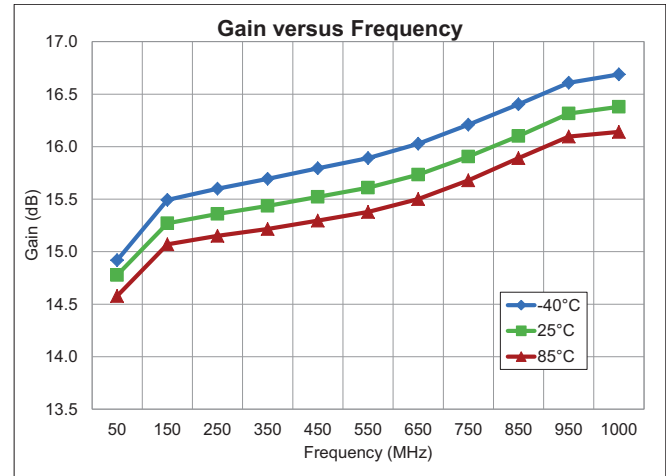
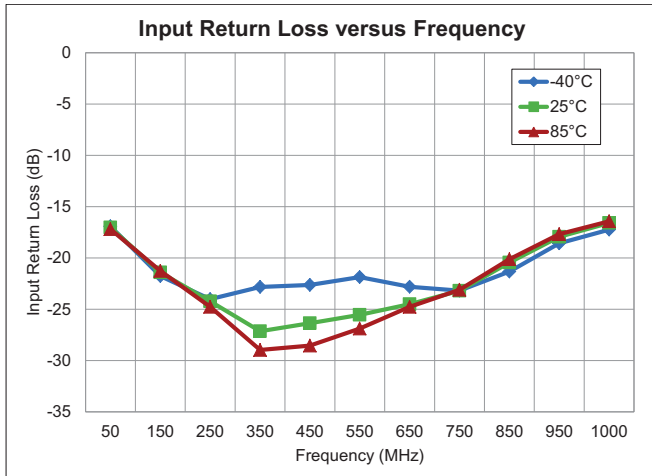

Performance 15dB Application Circuit $V_{CC} = 5V, I_{CC} = 150mA$

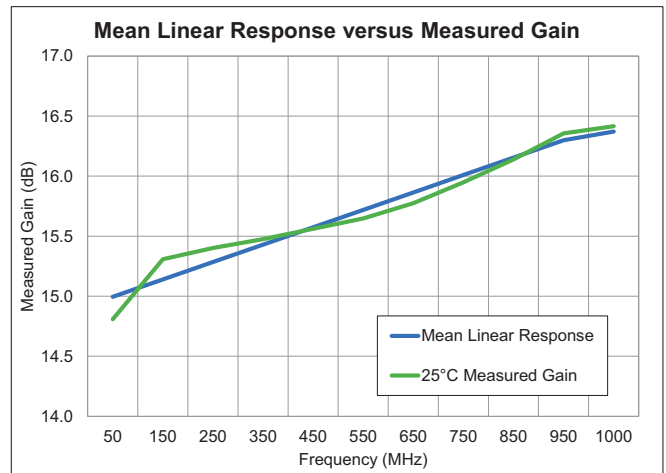
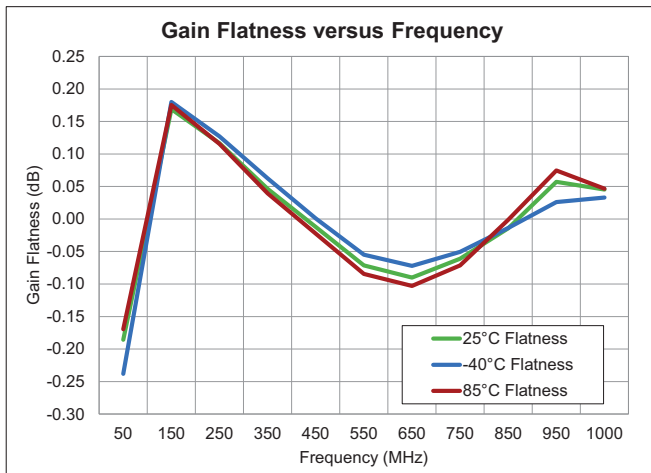
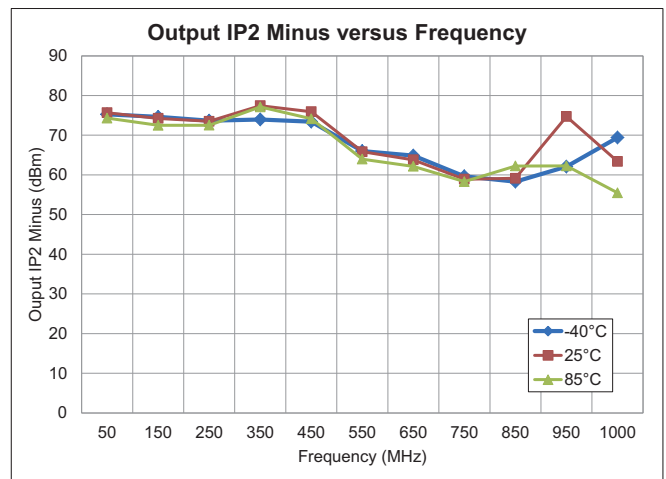
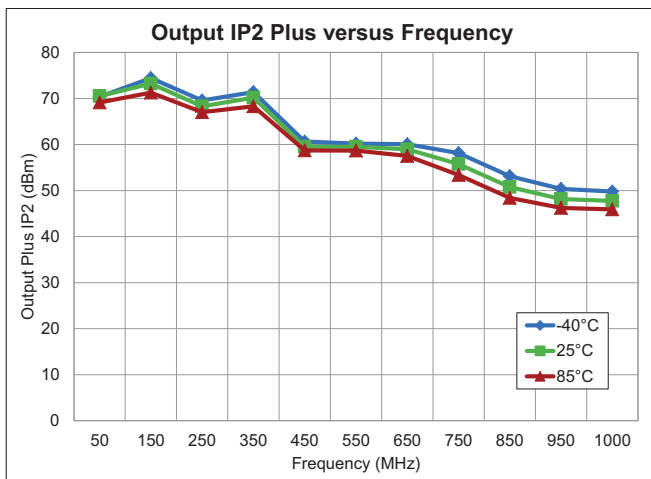
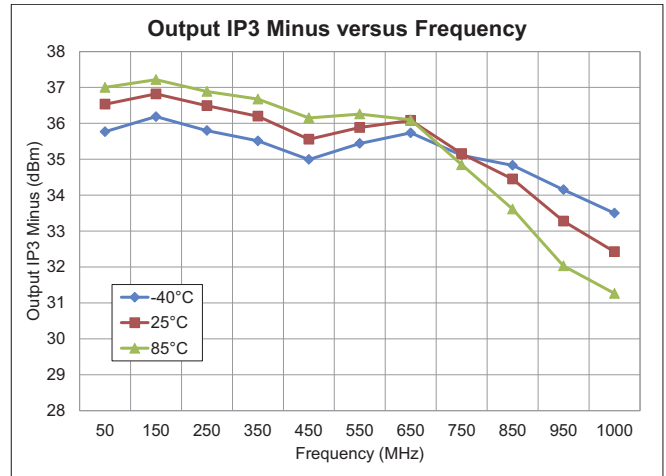
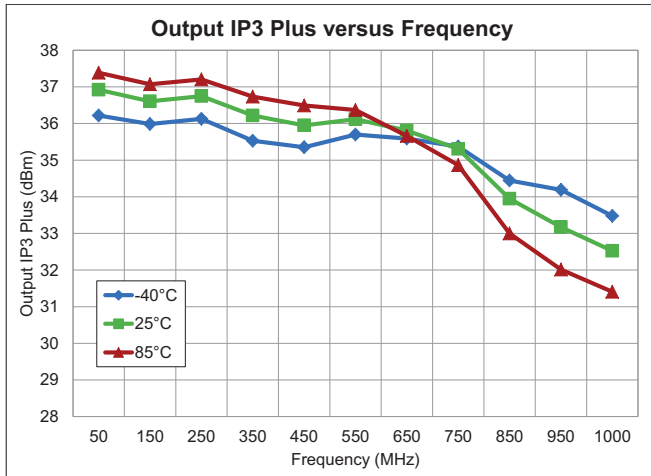

Performance 15dB Application Circuit $V_{CC} = 5V$, $I_{CC} = 150mA$

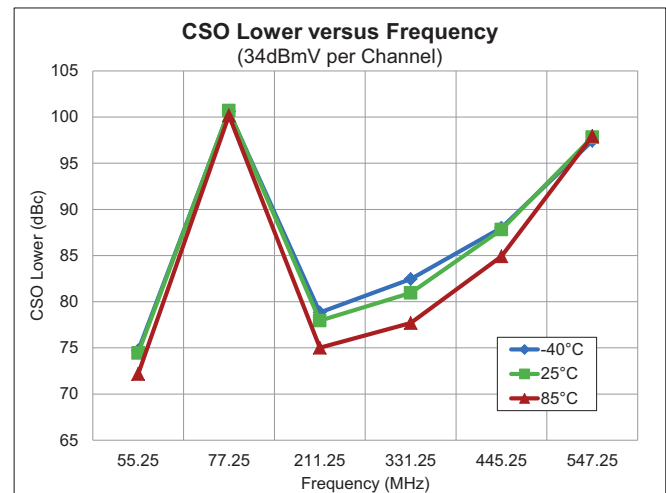
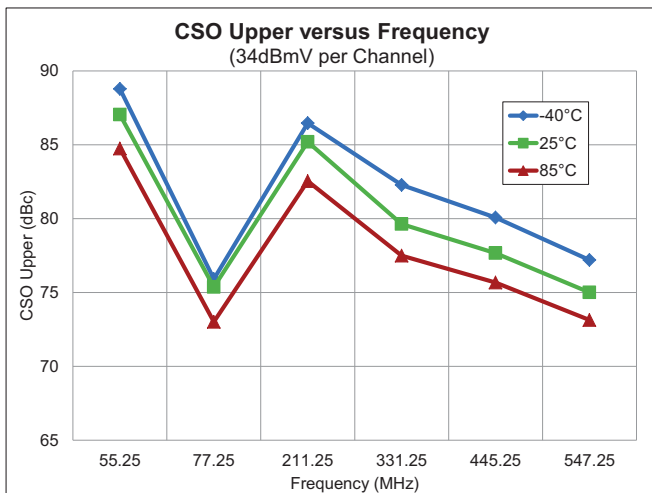
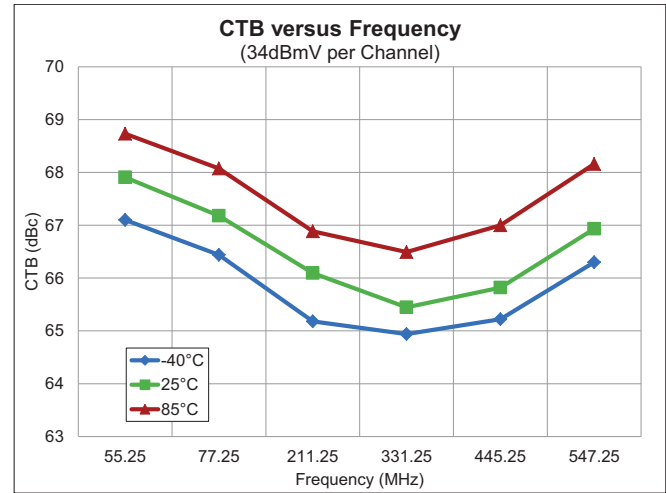
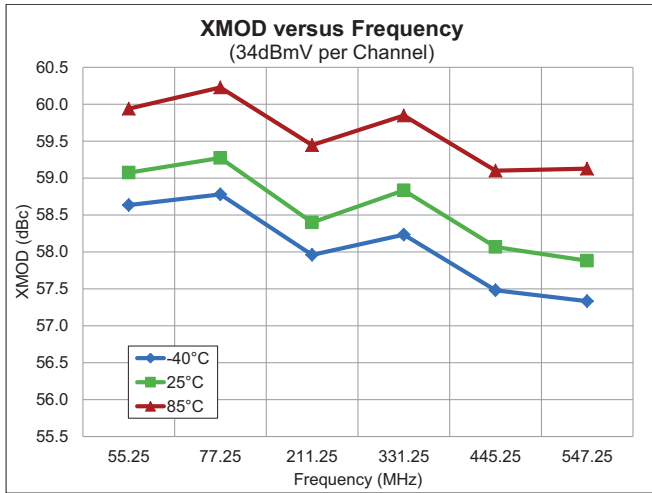

Evaluation Board Schematic
(15dB, 50MHz to 1000MHz Application Circuit)

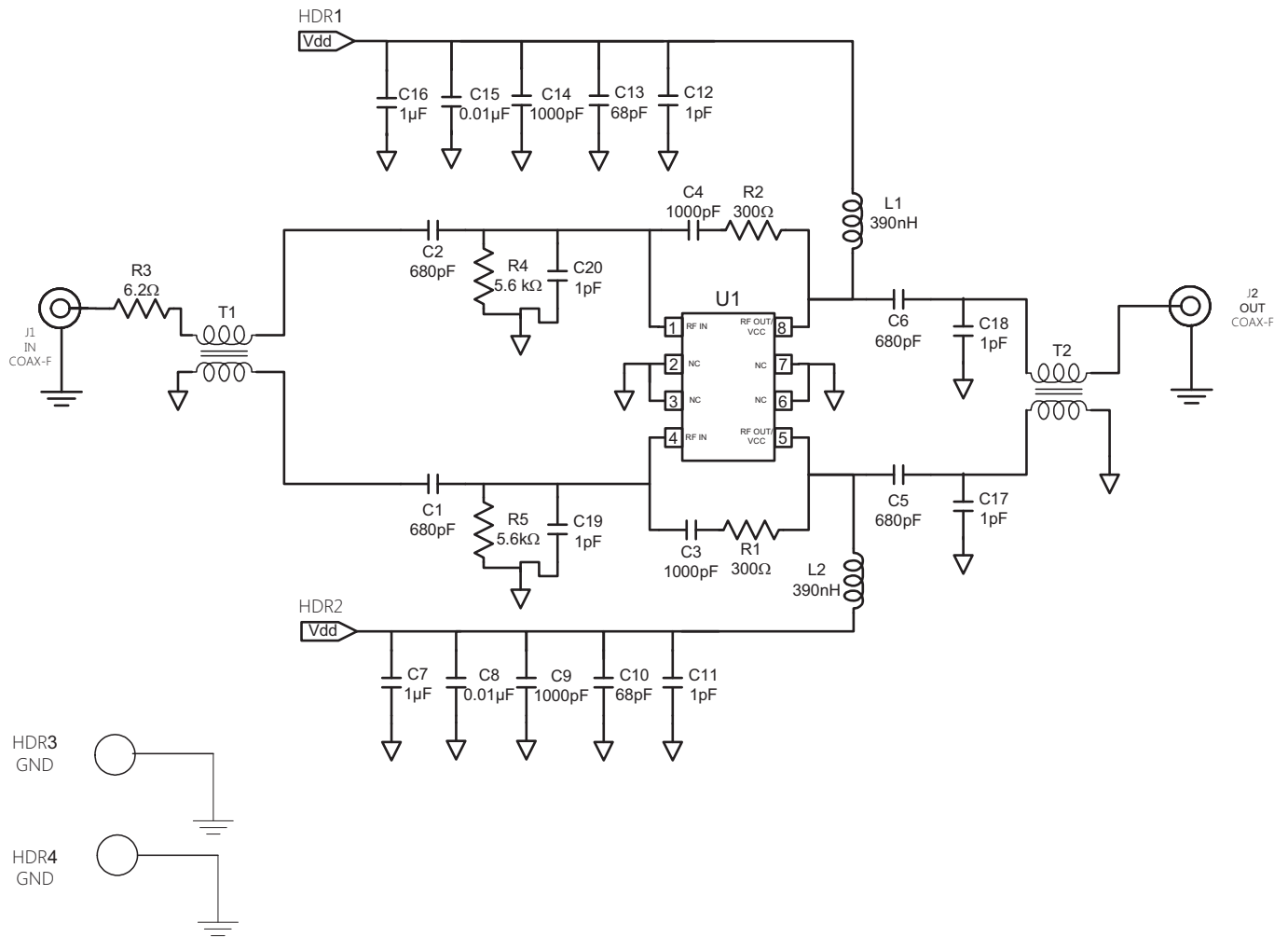

Evaluation Board Bill of Materials (BOM) (15dB, 50MHz to 1000MHz Application Circuit)

| Description | Reference Designator | Manufacturer | Manufacturer's P/N |
|---|----------------------|-----------------------------|--------------------|
| PCB, DEMO, 31 MIL BALANCED SOIC-8 CATV GA | | RFMD | 225107(B) |
| CONN, HDR, ST, 1-PIN, 0.100" | JP1-JP4 | Sullins Electronics Corp. | PEC01SAAN |
| CONN, F, EDGE MOUNT, 30 MIL | J1-J2 | Trompeter Electronics, Inc. | CBJE130-2 |
| IND, 390nH, 5%, W/W, 1008 | L1-L2 | Coilcraft | 1008CS-391XJBC |
| CAP, 0.010μF, 10%, 50V, X7R, 0603 | C8, C15 | Johanson Dielectrics | 500R14W103KV4 |
| CAP, 1pF, +/-0.25pF, 50V, C0G, 0603 | C11-C12, C17-C18 | Murata Electronics | GRM1885C1H1R0CZ01D |
| CAP, 1pF, +/-0.25pF, 50V, C0G, 0402 | C19-C20 | Murata Electronics | GRM1555C1H1R0CZ01E |
| CAP, 1000pF, 10%, 50V, X7R, 0402 | C3-C4 | Murata Electronics | GRM155R71H102KA01E |
| CAP, 1000pF, 10%, 50V, X7R, 0603 | C9, C14 | Murata Electronics | GRM188R71H102KA01D |
| CAP, 1μF, 10%, 25V, X5R, 0603 | C7, C16 | Taiyo Yuden (USA), Inc. | RM TMK107BJ105KA-T |
| CAP, 68pF, 5%, 50V, C0G, 0603 | C10, C13 | Murata Electronics | GRM1885C1H680JA01D |
| CAP, 680pF, 10%, 50V, X7R, 0603 | C1-C2, C5-C6 | Murata Electronics | GRM188R71H681KA01D |
| RES, 6.2Ω, 5%, 1/16W, 0603 | R3 | Panasonic Industrial Co | ERJ-3GEYJ6R2V |
| RES, 300Ω, 5%, 1/16W, 0402 | R1-R2 | Panasonic Industrial Co | ERJ-2GEJ301 |
| RES, 5.6K, 5%, 1/16W, 0603 | R4-R5 | Panasonic Industrial Co | ERJ-3GEYJ562 |
| TRANSFORMER, S03, 5MHz to 1000MHz, 1:1, UNBAL | T1-T2 | MiniRF | XFM-1002-1UH |
| DUAL CATV 5MHZ to 1000MHZ HI LIN GaAs HBT | U1 | RFMD | RFCA1008 |
| HEATSINK BLOCK, 1.5 x 2.0 IN | | | EEF-106820(B) |
| SCREW, 2-56 x 3/16", SOCKET HEAD | | McMaster-Carr Supply Co. | 92196A076 |

Evaluation Board Assembly Drawing
(15dB, 50MHz to 1000MHz Application Circuit)

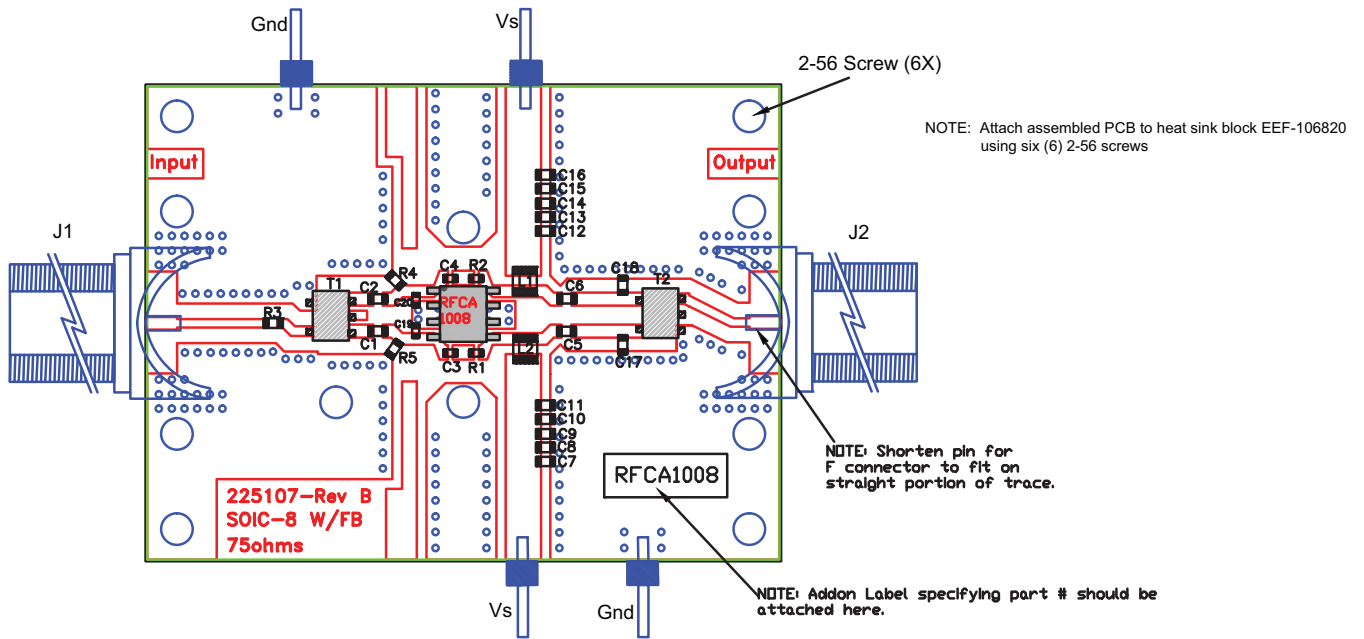

Performance 17dB Return Path $V_{CC} = 5V, I_{CC} = 215mA$

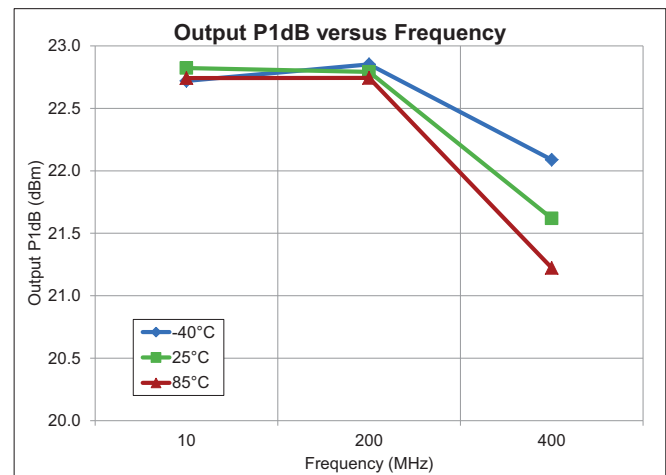
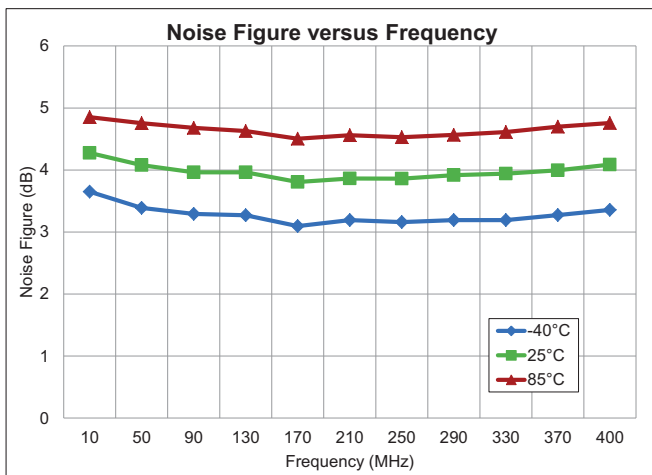
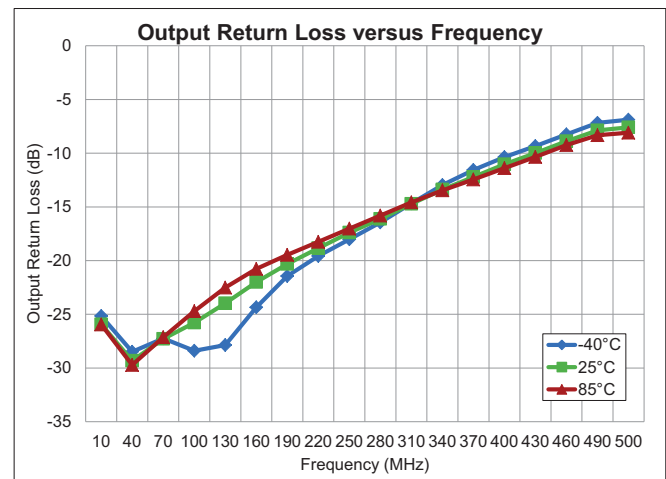
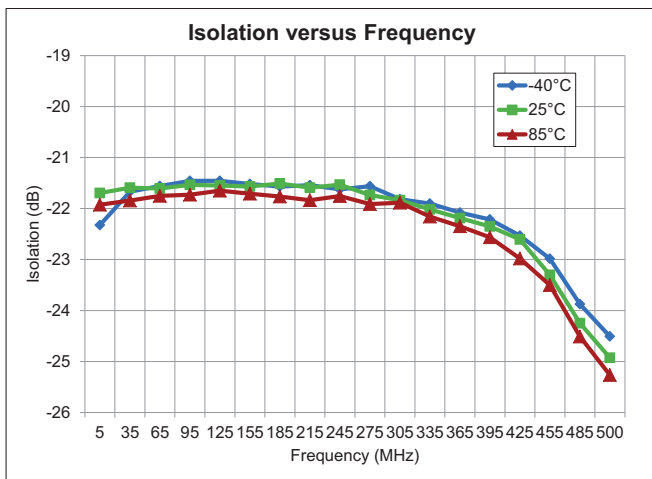
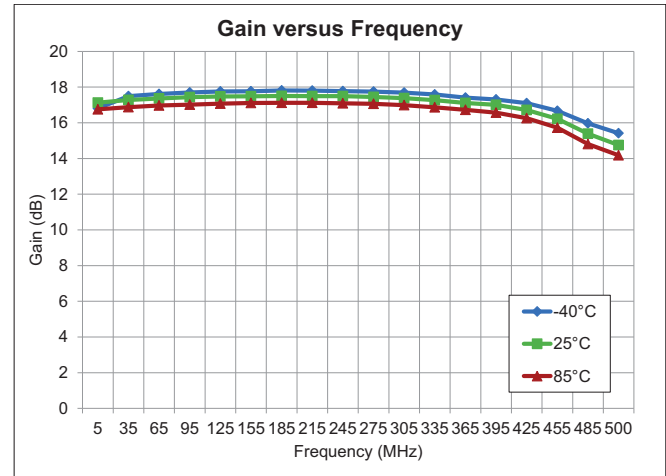
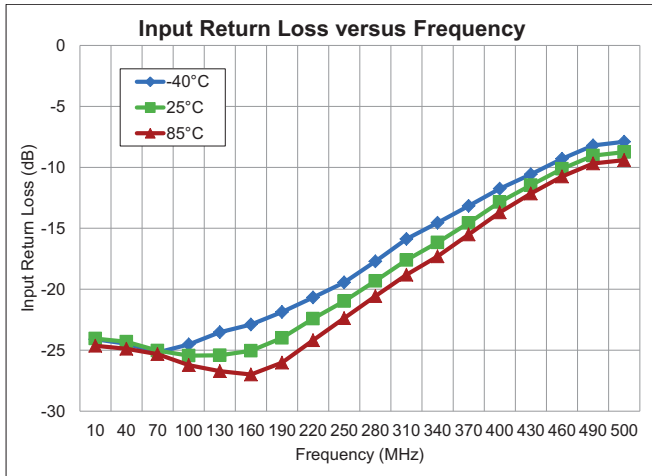

Performance 17dB Return Path $V_{CC} = 5V, I_{CC} = 215mA$

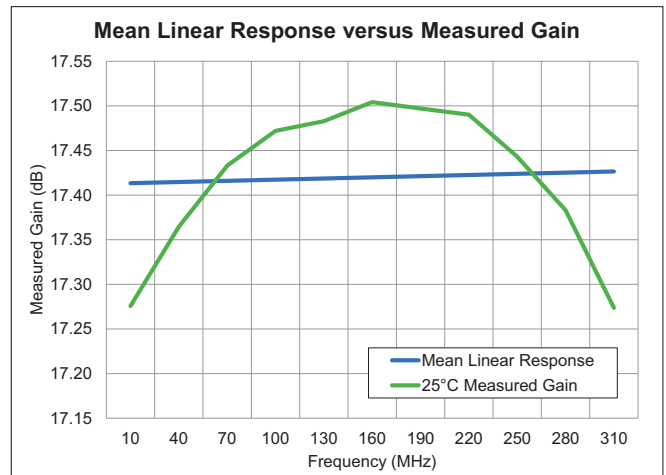
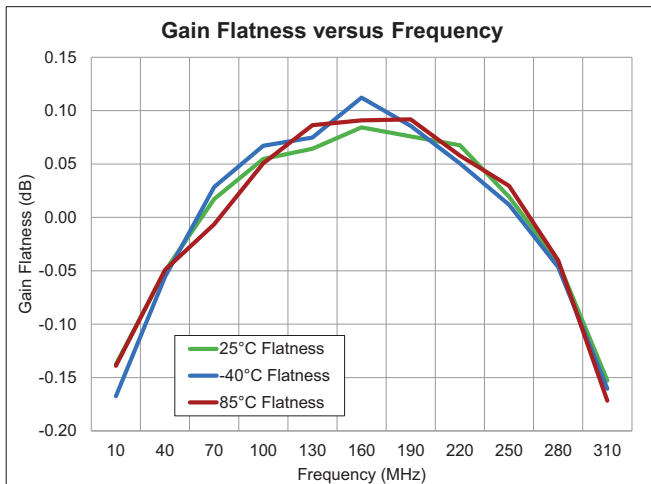
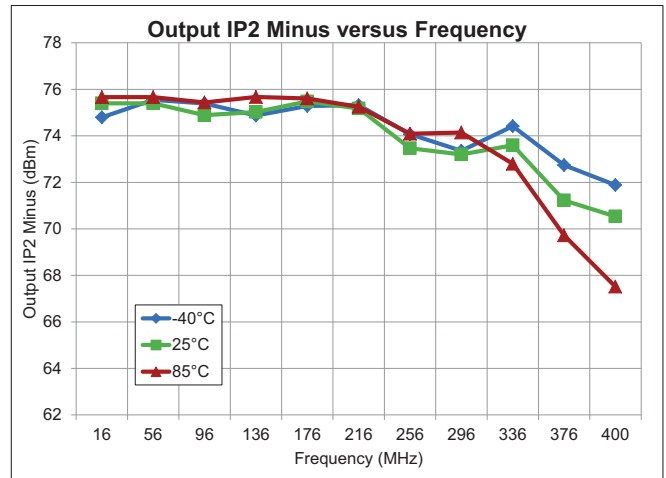
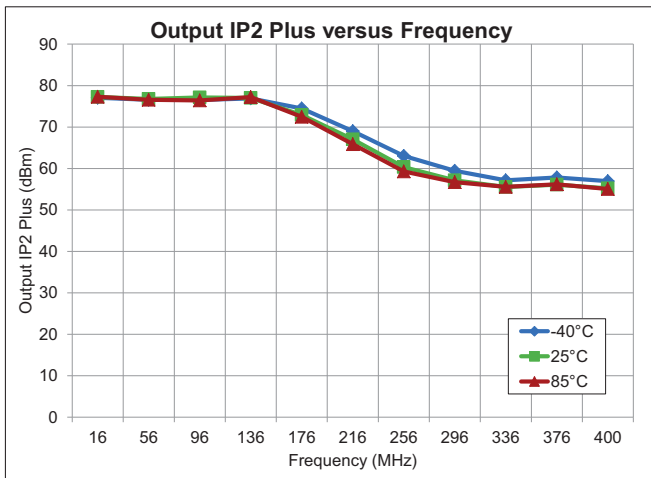
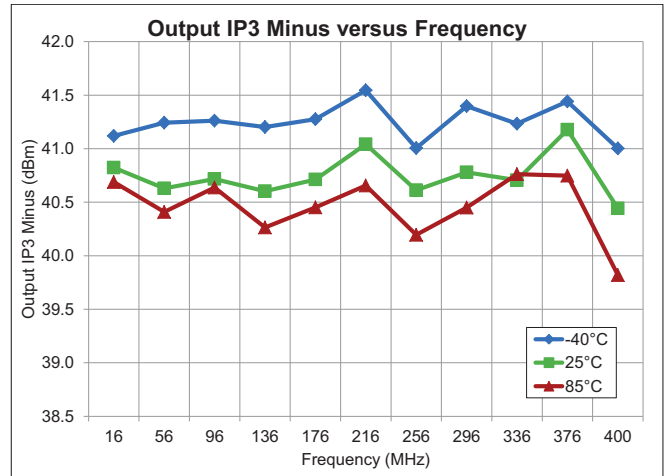
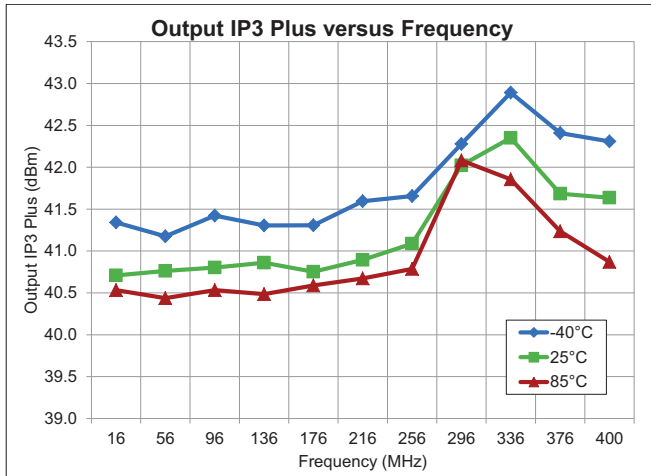

Performance 17dB Return Path $V_{CC} = 5V, I_{CC} = 215mA$

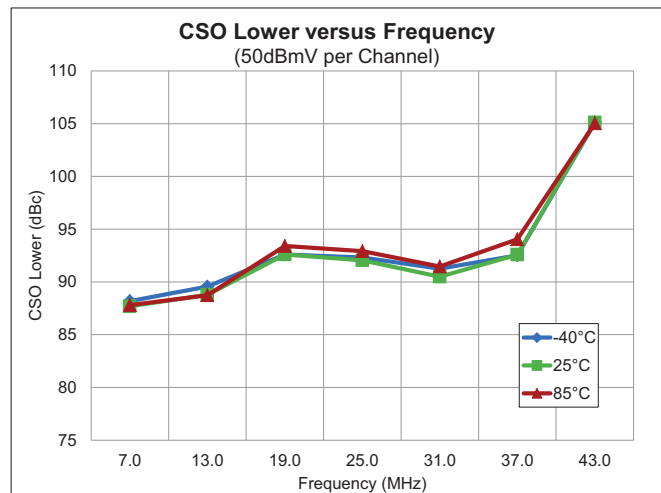
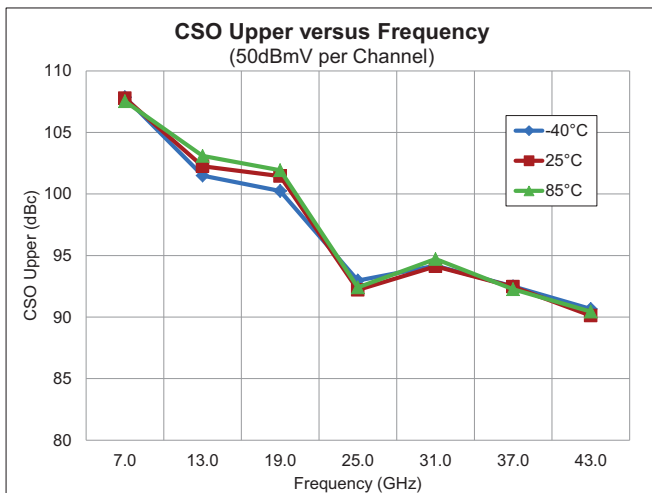
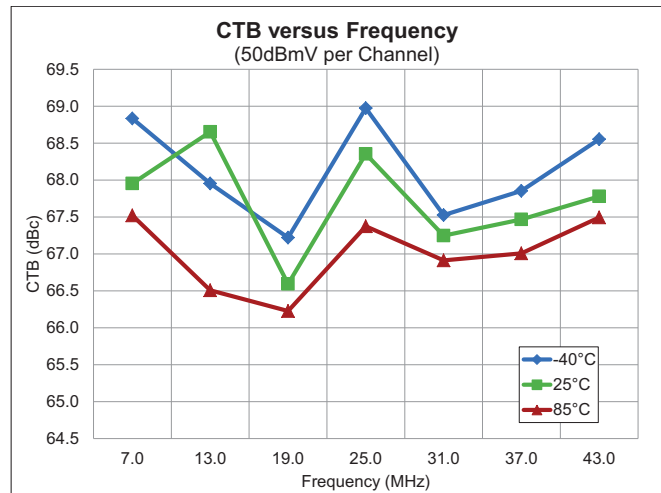
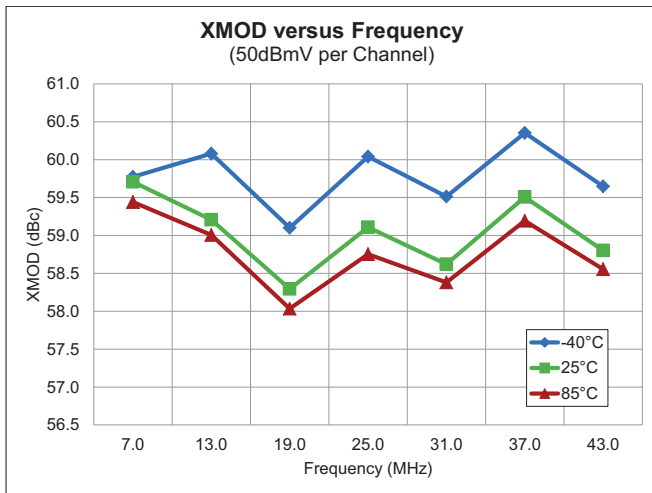

Evaluation Board Schematic
(17dB, 5MHz to 300MHz Application Circuit)

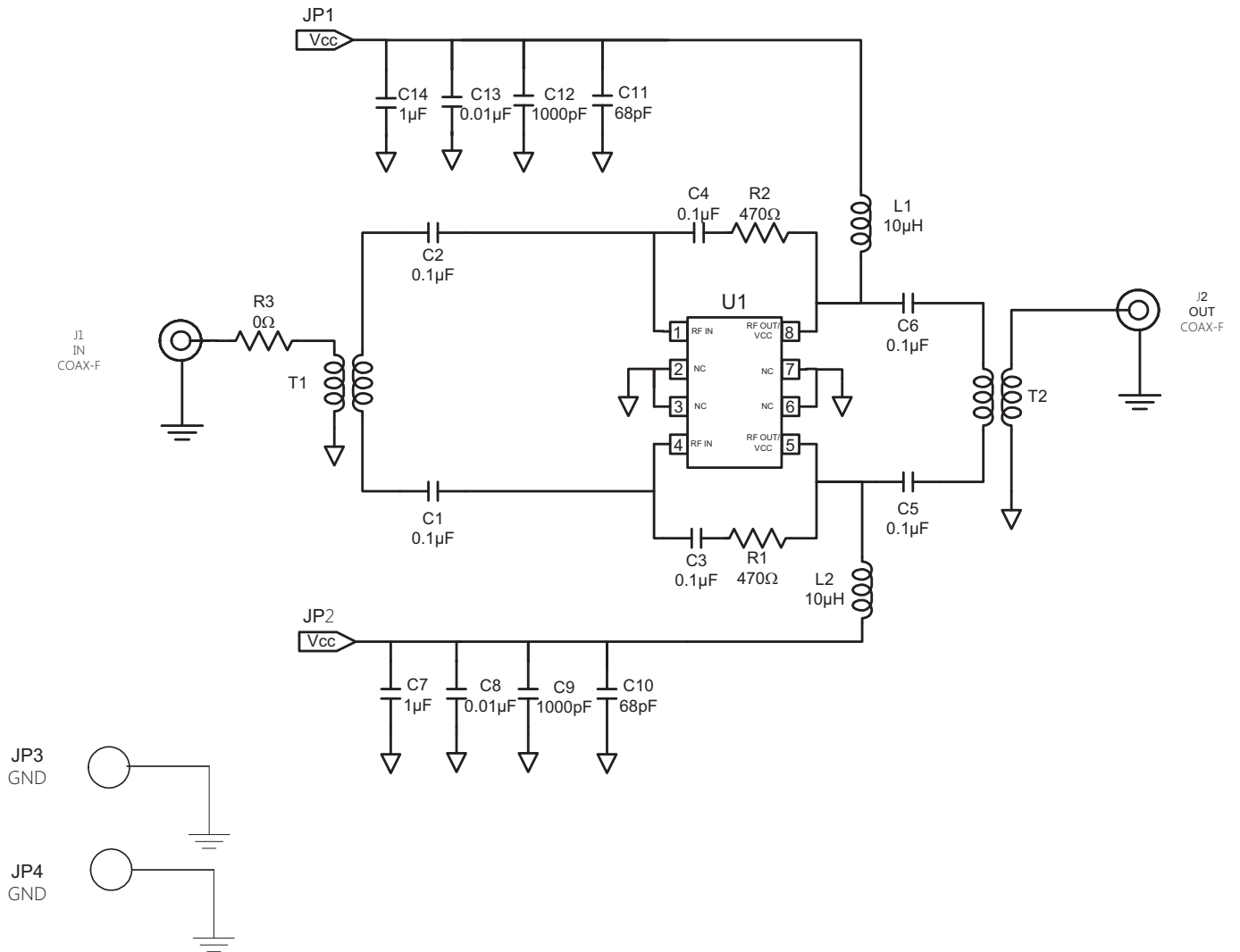

Evaluation Board Bill of Materials (BOM) (17dB, 5MHz to 300MHz Application Circuit)

| Description | Reference Designator | Manufacturer | Manufacturer's P/N |
|---|----------------------|-----------------------------|--------------------|
| PCB, DEMO, 31 MIL BALANCED SOIC-8 CATV GA | | RFMD | 225107(B) |
| DUAL CATV 5MHz to 1000MHZ HI LIN GaAs HBT | U1 | RFMD | RFCA1008 |
| CAP, 0.1µF, 10%, 25V, X7R, 0603 | C1-C2, C5-C6 | Kemet | C0603C104K3RAC |
| CAP, 0.1µF, 10%, 16V, X7R, 0402 | C3-C4 | Murata Electronics | GRM155R71C104KA88D |
| CAP, 1µF, 10%, 25V, X5R, 0603 | C7, C14 | Taiyo Yuden (USA), Inc. | RM TMK107BJ105KA-T |
| CAP, 68pF, 5%, 50V, C0G, 0603 | C10-C11 | Murata Electronics | GRM1885C1H680JA01D |
| CAP, 10000pF, 10%, 50V, X7R, 0603 | C8, C13 | Murata Electronics | GRM188R71H103KA01D |
| CAP, 1000pF, 10%, 50V, X7R, 0603 | C9, C12 | Murata Electronics | GRM188R71H102KA01D |
| RES, 0Ω, 0603 | R3 | Panasonic Industrial Co. | ERJ-3GEY0R00V |
| RES, 470Ω, 5%, 1/16W, 0402 | R1-R2 | Panasonic Industrial Co. | ERJ-2GEJ471 |
| IND, 10µH, 10%, W/W, 1008 | L1-L2 | Coilcraft | 1008LS-103XJLC |
| CONN, F, EDGE MOUNT, 30 MIL | J1-J2 | Trompeter Electronics, Inc. | CBJE130-2 |
| CONN, HDR, ST, 1-PIN, 0.100" | JP1-JP4 | Sullins Electronics Corp. | PBC01SAAN |
| TRANSFORMER, S03, 1:1, UNBAL | T1-T2 | MiniRF | XFM-0201-1WH |
| HEATSINK BLOCK, 1.5 x 2.0 IN | | | EEF-106820(B) |
| SCREW, 2-56 x 3/16", SOCKET HEAD | | McMaster-Carr Supply Co. | 92196A076 |

Pin Names and Descriptions

| Pin | Name | Description |
|-------------|------------------|--|
| 1 | RFIN | RF input pin. External DC-blocking capacitor is required. |
| 2 | GND | Connection to ground. Use via holes for best performance to reduce lead inductance as close to ground leads as possible. |
| 3 | GND | Connection to ground. Use via holes for best performance to reduce lead inductance as close to ground leads as possible. |
| 4 | RFIN | RF input pin. External DC-blocking capacitor is required. |
| 5 | RFOUT/VCC | RF output and bias pin (open collector). |
| 6 | GND | Connection to ground. Use via holes for best performance to reduce lead inductance as close to ground leads as possible. |
| 7 | GND | Connection to ground. Use via holes for best performance to reduce lead inductance as close to ground leads as possible. |
| 8 | RFOUT/VCC | RF output and bias pin (open collector). |
| EPAD | GND | Exposed area on the bottom side of the package must be soldered to the ground plane of the board for optimum thermal and RF performance. Several vias should be located under the EPAD as shown in the recommended land pattern. |

Suggested Pad Layout

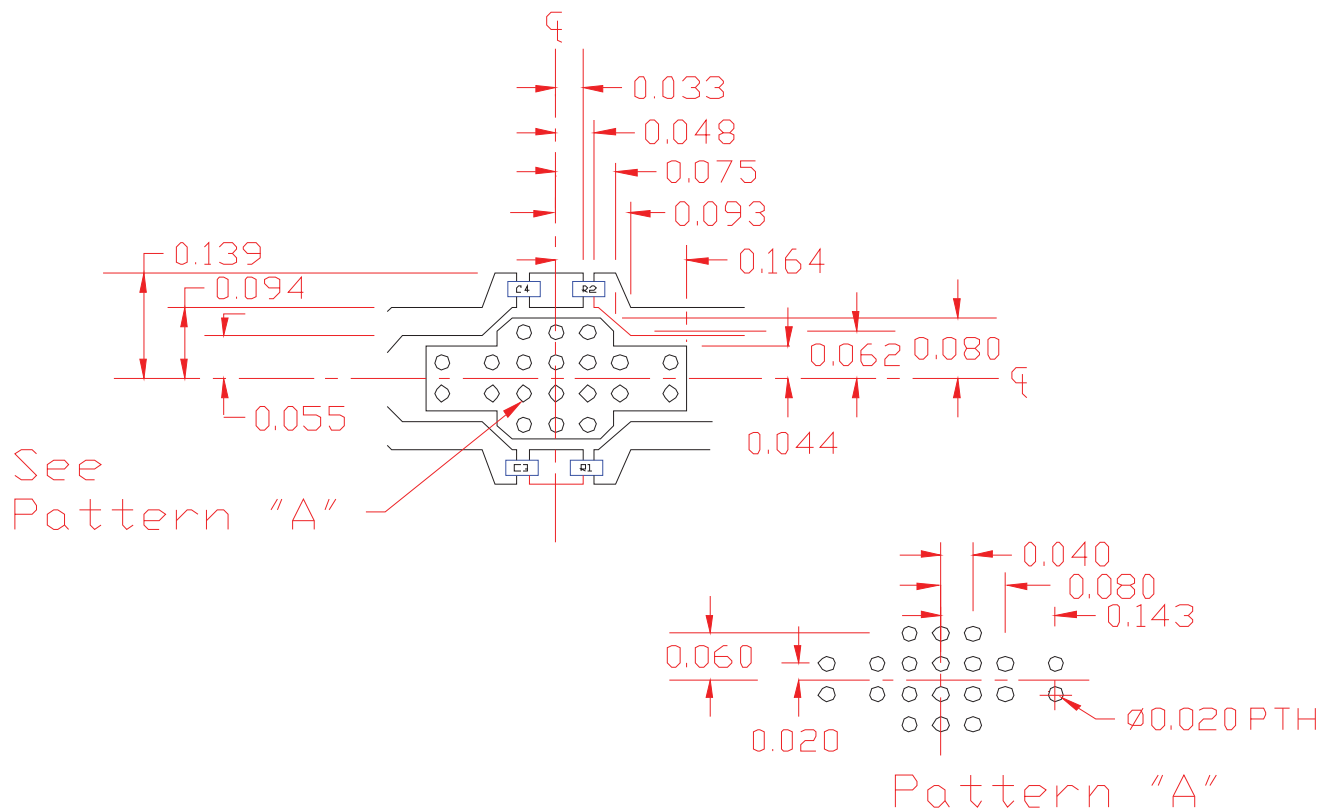

Package Drawing

Dimensions in millimeters

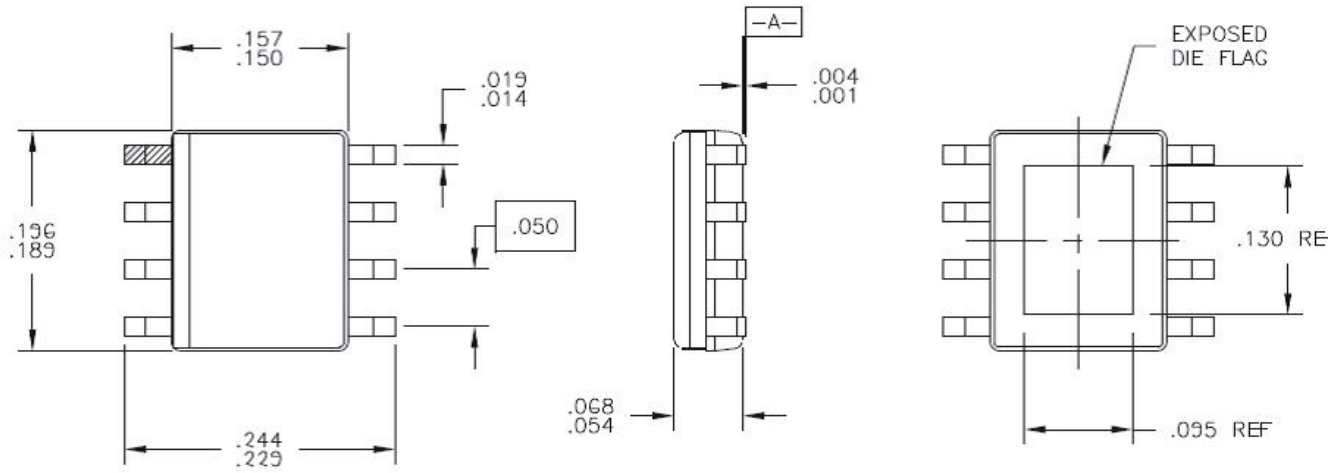

NOTES:

1. SHADED LEAD IS PIN 1.
2. LEAD COPLANARITY: $.003$ WITH RESPECT TO DATUM 'A'.
3. DIMENSIONS DO NOT INCLUDE MOLD FLASH OR PROTRUSIONS.

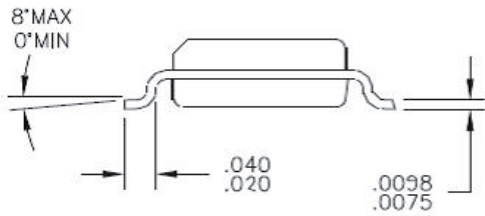

Branding Diagram

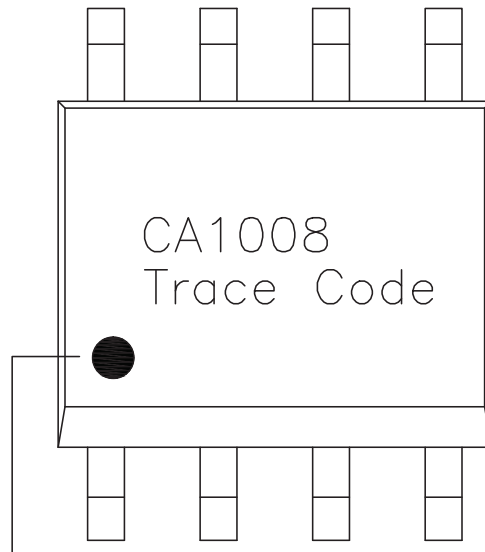

Pin 1 Indicator
Trace Code to be assigned
by Subcon



Компания «ЭлектроПласт» предлагает заключение долгосрочных отношений при поставках импортных электронных компонентов на взаимовыгодных условиях!

Наши преимущества:

- Оперативные поставки широкого спектра электронных компонентов отечественного и импортного производства напрямую от производителей и с крупнейших мировых складов;
- Поставка более 17-ти миллионов наименований электронных компонентов;
- Поставка сложных, дефицитных, либо снятых с производства позиций;
- Оперативные сроки поставки под заказ (от 5 рабочих дней);
- Экспресс доставка в любую точку России;
- Техническая поддержка проекта, помощь в подборе аналогов, поставка прототипов;
- Система менеджмента качества сертифицирована по Международному стандарту ISO 9001;
- Лицензия ФСБ на осуществление работ с использованием сведений, составляющих государственную тайну;
- Поставка специализированных компонентов (Xilinx, Altera, Analog Devices, Intersil, Interpoint, Microsemi, Aeroflex, Peregrine, Syfer, Eurofarad, Texas Instrument, Miteq, Cobham, E2V, MA-COM, Hittite, Mini-Circuits, General Dynamics и др.);

Помимо этого, одним из направлений компании «ЭлектроПласт» является направление «Источники питания». Мы предлагаем Вам помощь Конструкторского отдела:

- Подбор оптимального решения, техническое обоснование при выборе компонента;
- Подбор аналогов;
- Консультации по применению компонента;
- Поставка образцов и прототипов;
- Техническая поддержка проекта;
- Защита от снятия компонента с производства.



Как с нами связаться

Телефон: 8 (812) 309 58 32 (многоканальный)

Факс: 8 (812) 320-02-42

Электронная почта: org@eplast1.ru

Адрес: 198099, г. Санкт-Петербург, ул. Калинина, дом 2, корпус 4, литера А.