

# Wire Wound Common Mode Choke for USB3.0

ACM-21U



RoHS/RoHS II compliant



2.0 x 1.2 x 1.2mm

## FEATURES:

- Small size and low profile
- Virtually no effect on high speed signals due to suppressed differential mode impedance
- Elimination of common mode noise in high speed, differential mode signal transmission lines such as USB3.0

## APPLICATIONS:

- High speed differential signal lines in USB3.0

## STANDARD SPECIFICATIONS

Abracon P/N:	ACM-21U
Operating Temperature & Humidity:	-40°C to +85°C
Storage Temperature & Humidity:	-10°C to +40°C, Humidity < 70%RH (In tape and reel)

Part Number	Impedance @100MHz	DCR	I <sub>R</sub>	Rated Voltage	Insulation Resistance
Units	Ω ± 25%	Ω (max.)	mA	Vdc	MΩ (min.)
ACM-21U-900	90	0.40	280	20	10

### Test Conditions

**Impedance (Common mode and differential mode):** LCR Meter Agilent 4287A/E4991A

**DCR:** Agilent 4338B/34420

**I<sub>R</sub>:** Electric power, Electrical current meter, Thermometer

**Definition of Rated Current (I<sub>R</sub>):** The direct electric current as chip surface temperature rise just 20°C against chip initial surface temperature.

**Insertion Loss:** Network Analyzer Agilent E5071C

**Insulation Resistance:** High resistance meter Agilent 4339B

## PART IDENTIFICATION:

ACM-21U-  -



### Impedance Code

Please refer to the table above

### Packaging

Blank: bulk  
T: Tape and Reel (2k pcs/reel)

# Wire Wound Common Mode Choke for USB3.0

ACM-21U



RoHS/RoHS II compliant



2.0 x 1.2 x 1.2mm

## ELECTRICAL CHARACTERISTIC CURVE:

Impedance vs. Frequency

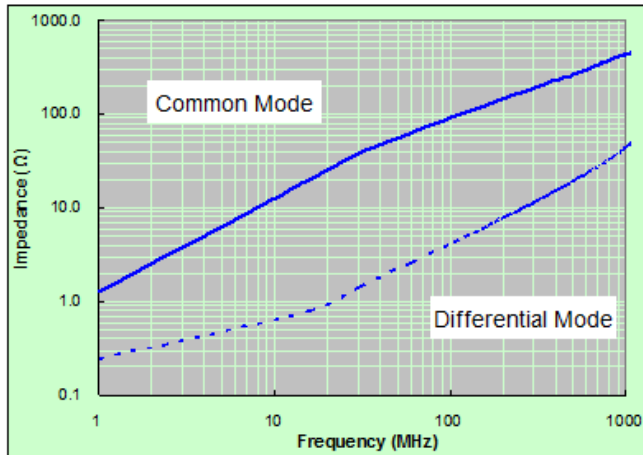

Insertion Loss

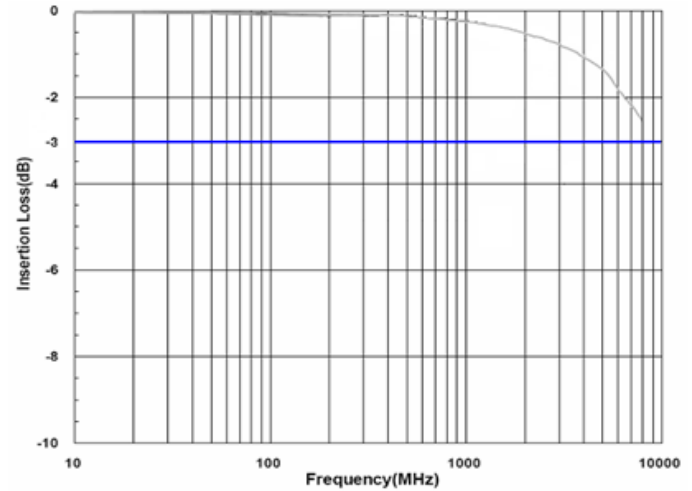

Characteristic Impedance

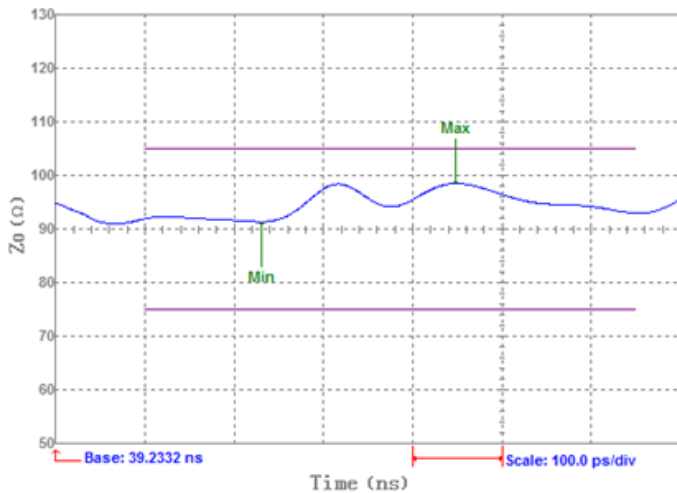

Eye Diagram in USB3.0

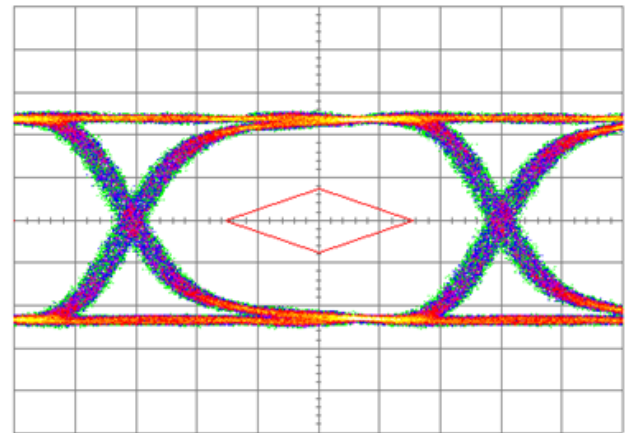

# Wire Wound Common Mode Choke for USB3.0

ACM-21U



RoHS/RoHS II compliant



2.0 x 1.2 x 1.2mm

## OUTLINE DIMENSIONS:

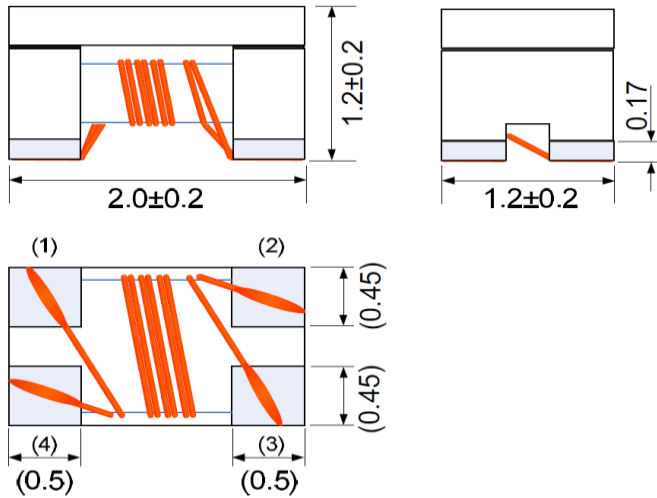

## Recommended Land Pattern

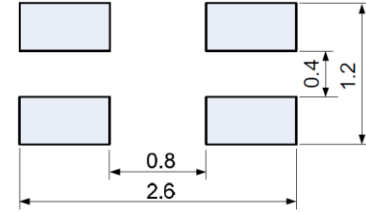

## Schematic

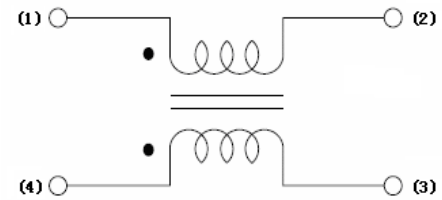

## Materials

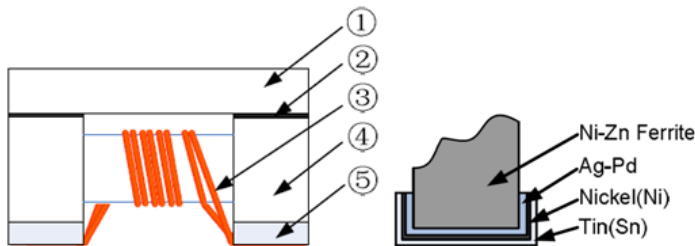

No.	Part Name	Material Name
①	Lid	Ni-Zn Ferrite
②	Epoxy	Epoxy resin
③	Wire	Polyurethane system enameled copper wire
④	Core	Ni-Zn Ferrite
⑤	Electrode structure	(Ag-Pd)+Ni+Sn plating

## REFLOW PROFILE:

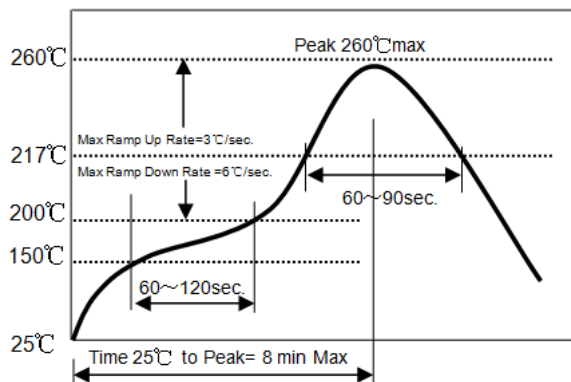

- △ Preheat condition: 150~200 C/60~120sec.
- △ Allowed time above 217C: 60~90sec.
- △ Max temp: 260°C
- △ Max time at max temp: 10sec.
- △ Solder paste: Sn/3.0Ag/0.5Cu
- △ Allowed Reflow time: 2 times max.

ABRACON IS  
ISO 9001:2008  
CERTIFIED



Visit [www.abracon.com](http://www.abracon.com) for Terms & Conditions of Sale  
30332 Esperanza, Rancho Santa Margarita, California 92688  
tel 949-546-8000 | fax 949-546-8001 | [www.abracon.com](http://www.abracon.com)

Revised: 02.20.14

# Wire Wound Common Mode Choke for USB3.0

ACM-21U



RoHS/RoHS II compliant



2.0 x 1.2 x 1.2mm

TAPE & REEL: 2000pcs/reel

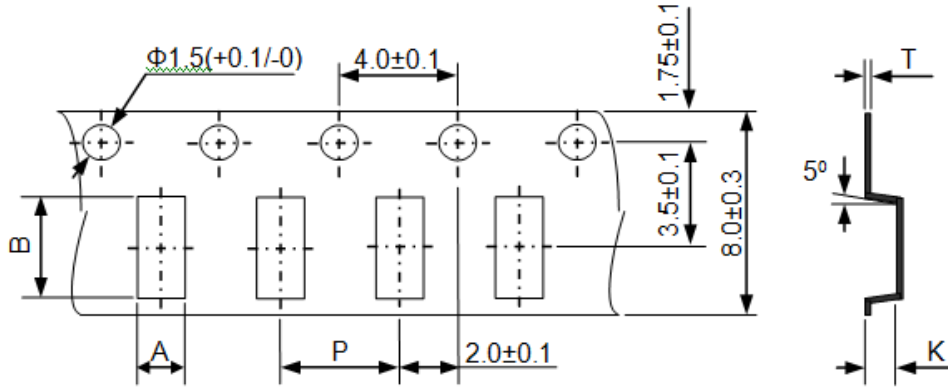

A	B	P	K	T
$1.55 \pm 0.2$	$2.25 \pm 0.2$	$4.0 \pm 0.1$	$1.45 \pm 0.1$	$0.2 \pm 0.1$

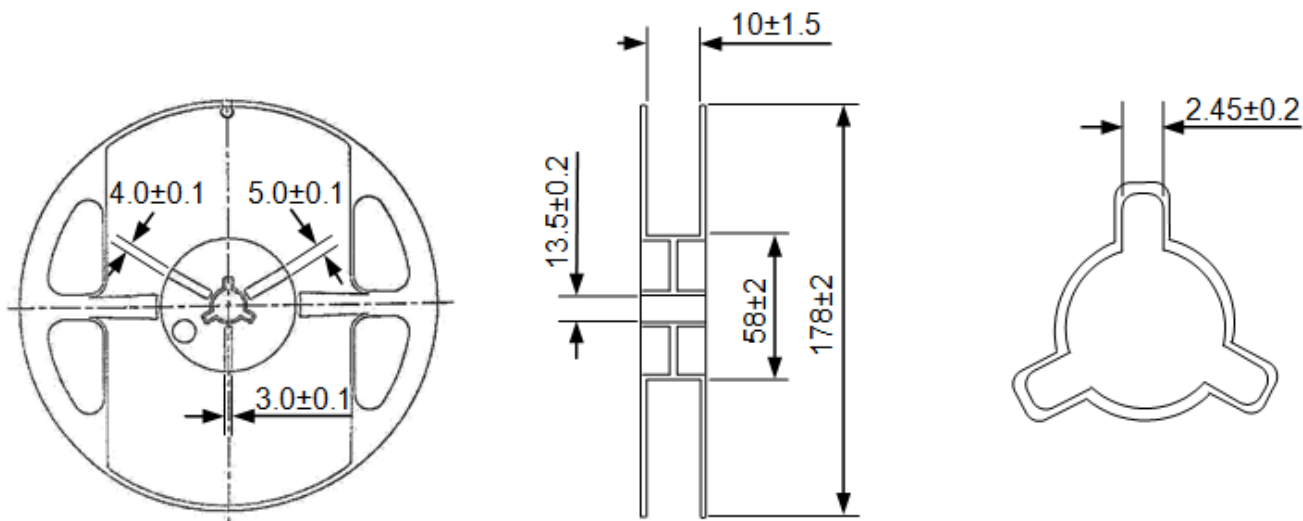

Dimension: mm

**ATTENTION:** Abracon Corporation's products are COTS – Commercial-Off-The-Shelf products; suitable for Commercial, Industrial and, where designated, Automotive Applications. Abracon's products are not specifically designed for Military, Aviation, Aerospace, Life-dependant Medical applications or any application requiring high reliability where component failure could result in loss of life and/or property. For applications requiring high reliability and/or presenting an extreme operating environment, written consent and authorization from Abracon Corporation is required. Please contact Abracon Corporation for more information.

ABRACON IS  
ISO 9001:2008  
CERTIFIED



Visit [www.abracon.com](http://www.abracon.com) for Terms & Conditions of Sale **Revised: 02.20.14**  
30332 Esperanza, Rancho Santa Margarita, California 92688  
tel 949-546-8000 | fax 949-546-8001 | [www.abracon.com](http://www.abracon.com)



Компания «ЭлектроПласт» предлагает заключение долгосрочных отношений при поставках импортных электронных компонентов на взаимовыгодных условиях!

Наши преимущества:

- Оперативные поставки широкого спектра электронных компонентов отечественного и импортного производства напрямую от производителей и с крупнейших мировых складов;
- Поставка более 17-ти миллионов наименований электронных компонентов;
- Поставка сложных, дефицитных, либо снятых с производства позиций;
- Оперативные сроки поставки под заказ (от 5 рабочих дней);
- Экспресс доставка в любую точку России;
- Техническая поддержка проекта, помощь в подборе аналогов, поставка прототипов;
- Система менеджмента качества сертифицирована по Международному стандарту ISO 9001;
- Лицензия ФСБ на осуществление работ с использованием сведений, составляющих государственную тайну;
- Поставка специализированных компонентов (Xilinx, Altera, Analog Devices, Intersil, Interpoint, Microsemi, Aeroflex, Peregrine, Syfer, Eurofarad, Texas Instrument, Miteq, Cobham, E2V, MA-COM, Hittite, Mini-Circuits, General Dynamics и др.);

Помимо этого, одним из направлений компании «ЭлектроПласт» является направление «Источники питания». Мы предлагаем Вам помощь Конструкторского отдела:

- Подбор оптимального решения, техническое обоснование при выборе компонента;
- Подбор аналогов;
- Консультации по применению компонента;
- Поставка образцов и прототипов;
- Техническая поддержка проекта;
- Защита от снятия компонента с производства.



#### Как с нами связаться

**Телефон:** 8 (812) 309 58 32 (многоканальный)

**Факс:** 8 (812) 320-02-42

**Электронная почта:** [org@eplast1.ru](mailto:org@eplast1.ru)

**Адрес:** 198099, г. Санкт-Петербург, ул. Калинина, дом 2, корпус 4, литера А.