



ECH8690

Power MOSFET

60V, 4.7A, 55mΩ -60V, -3.5A, 94mΩ Complementary Dual ECH8

ON Semiconductor®

<http://onsemi.com>

Features

- On-State Resistance Nch:RDS(on)1=42mΩ(typ.)
Pch:RDS(on)1=73mΩ(typ.)
- 4V drive
- Nch+Pch MOSFET
- Protection diode in
- Halogen free compliance

Specifications

Absolute Maximum Ratings at Ta = 25°C

Parameter	Symbol	Conditions	N-channel	P-channel	Unit
Drain to Source Voltage	V _{DSS}		60	-60	V
Gate to Source Voltage	V _{GSS}		±20	±20	V
Drain Current (DC)	I _D		4.7	-3.5	A
Drain Current (Pulse)	I _{DP}	PW≤10μs, duty cycle≤1%	30	-30	A
Allowable Power Dissipation	P _D	When mounted on ceramic substrate (1200mm ² ×0.8mm)1unit		1.5	W
Total Dissipation	P _T	When mounted on ceramic substrate (1200mm ² ×0.8mm)		1.8	W
Channel Temperature	T _{ch}			150	°C
Storage Temperature	T _{stg}			-55 to +150	°C

Stresses exceeding Maximum Ratings may damage the device. Maximum Ratings are stress ratings only. Functional operation above the Recommended Operating Conditions is not implied. Extended exposure to stresses above the Recommended Operating Conditions may affect device reliability.

Package Dimensions

unit : mm (typ)
7011A-001

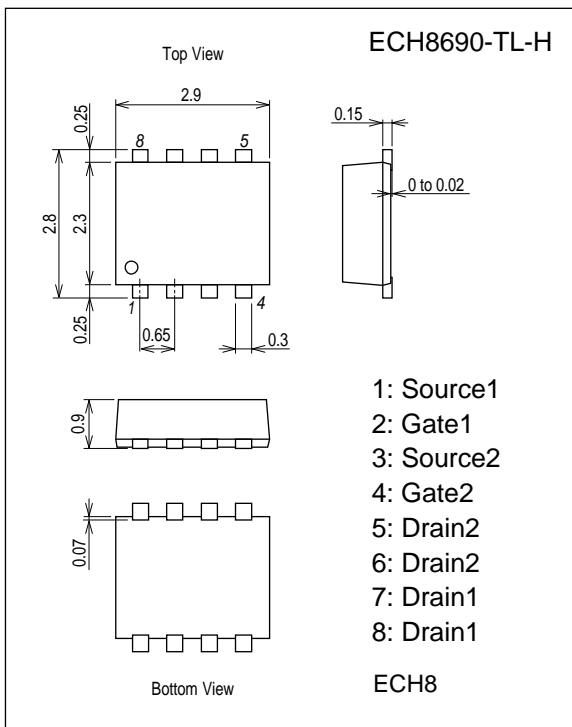

Ordering & Package Information

Device	Package	Shipping	note
ECH8690-TL-H	ECH8	3000 pcs. / reel	Pb-Free and Halogen Free

Packing Type: TL

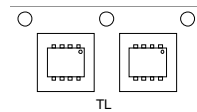

Marking

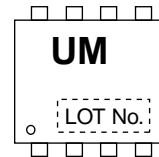

Electrical Connection

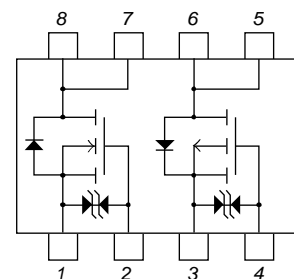

ECH8690

Electrical Characteristics at Ta = 25°C

Parameter	Symbol	Conditions	Ratings			Unit
			min	typ	max	
[N-channel]						
Drain to Source Breakdown Voltage	V(BR)DSS	ID=1mA, VGS=0V	60			V
Zero-Gate Voltage Drain Current	IDSS	VDS=60V, VGS=0V			1	μA
Gate to Source Leakage Current	IGSS	VGS=±16V, VDS=0V			±10	μA
Cutoff Voltage	VGS(off)	VDS=10V, ID=1mA	1.2		2.6	V
Forward Transfer Admittance	yfs	VDS=10V, ID=2A		4.2		S
Static Drain to Source On-State Resistance	RDS(on)1	ID=2A, VGS=10V		42	55	mΩ
	RDS(on)2	ID=1A, VGS=4.5V		53	74	mΩ
	RDS(on)3	ID=1A, VGS=4V		61	85	mΩ
Input Capacitance	Ciss	VDS=20V, f=1MHz		955		pF
Output Capacitance	Coss			58		pF
Reverse Transfer Capacitance	Crss			45		pF
Turn-ON Delay Time	t _{d(on)}			7		ns
Rise Time	t _r	See specified Test Circuit.		8.4		ns
Turn-OFF Delay Time	t _{d(off)}			76		ns
Fall Time	t _f			23		ns
Total Gate Charge	Qg	VDS=30V, VGS=10V, ID=4.7A		18		nC
Gate to Source Charge	Qgs			3		nC
Gate to Drain "Miller" Charge	Qgd			2.8		nC
Diode Forward Voltage	VSD	IS=4.7A, VGS=0V		0.82	1.2	V
[P-channel]						
Drain to Source Breakdown Voltage	V(BR)DSS	ID=-1mA, VGS=0V	-60			V
Zero-Gate Voltage Drain Current	IDSS	VDS=-60V, VGS=0V			-1	μA
Gate to Source Leakage Current	IGSS	VGS=±16V, VDS=0V			±10	μA
Cutoff Voltage	VGS(off)	VDS=-10V, ID=-1mA	-1.2		-2.6	V
Forward Transfer Admittance	yfs	VDS=-10V, ID=-1.5A		3.4		S
Static Drain to Source On-State Resistance	RDS(on)1	ID=-1A, VGS=-10V		73	94	mΩ
	RDS(on)2	ID=-0.5A, VGS=-4.5V		97	135	mΩ
	RDS(on)3	ID=-0.5A, VGS=-4V		108	153	mΩ
Input Capacitance	Ciss	VDS=-20V, f=1MHz		790		pF
Output Capacitance	Coss			63		pF
Reverse Transfer Capacitance	Crss			45		pF
Turn-ON Delay Time	t _{d(on)}			10		ns
Rise Time	t _r	See specified Test Circuit.		8.8		ns
Turn-OFF Delay Time	t _{d(off)}			84		ns
Fall Time	t _f			29		ns
Total Gate Charge	Qg	VDS=-30V, VGS=-10V, ID=-3.5A		15		nC
Gate to Source Charge	Qgs			2.6		nC
Gate to Drain "Miller" Charge	Qgd			2.2		nC
Diode Forward Voltage	VSD	IS=-3.5A, VGS=0V		-0.83	-1.2	V

Switching Time Test Circuit

[N-channel]

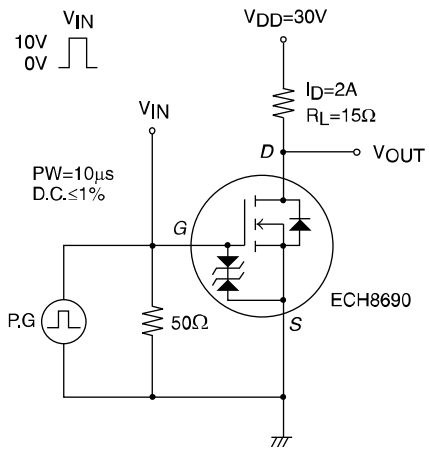

[P-channel]

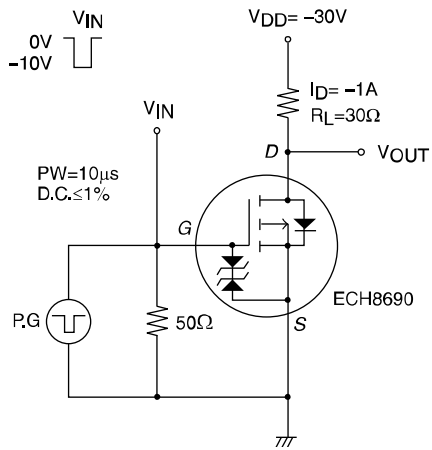

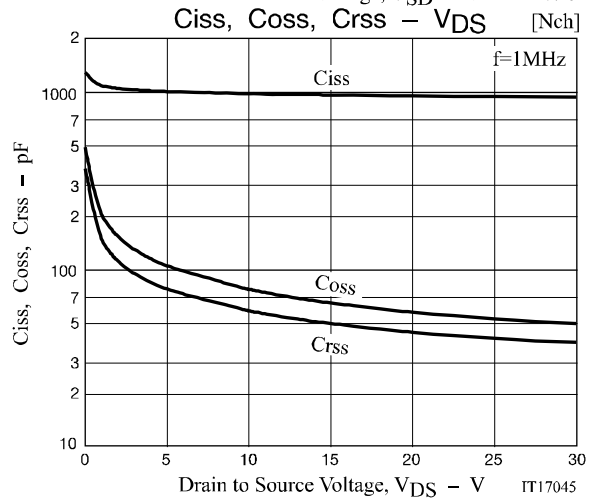
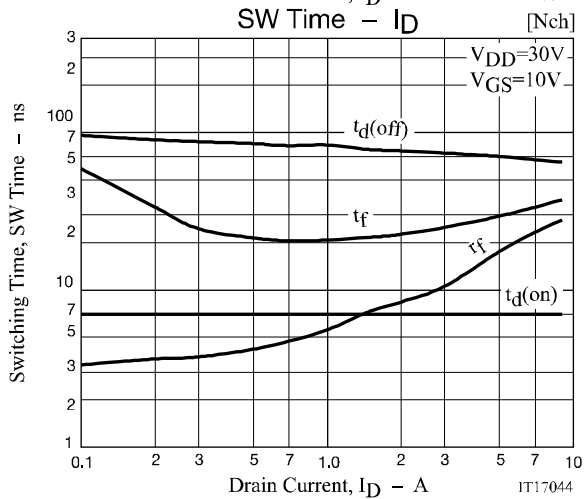
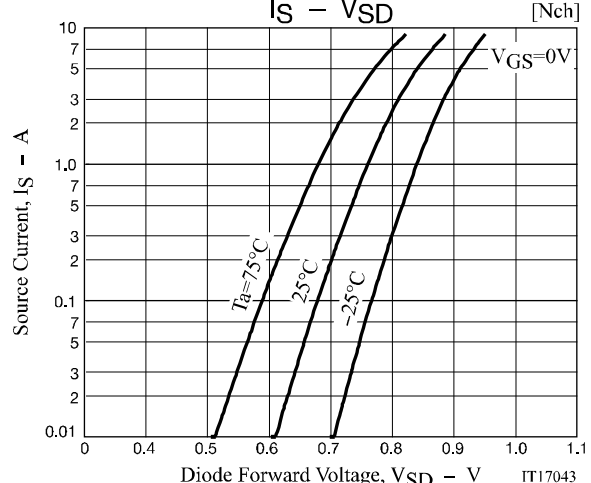
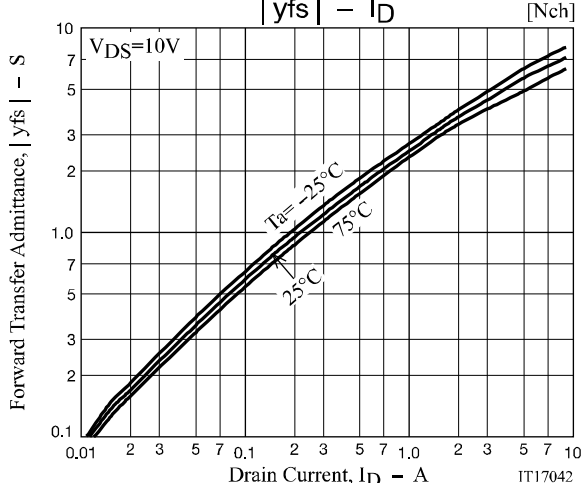
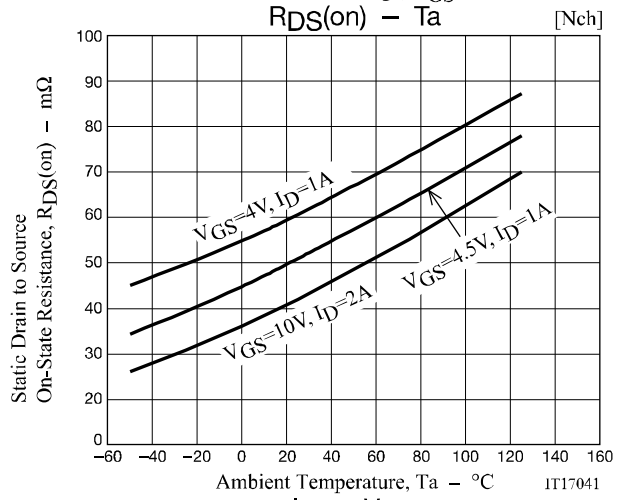
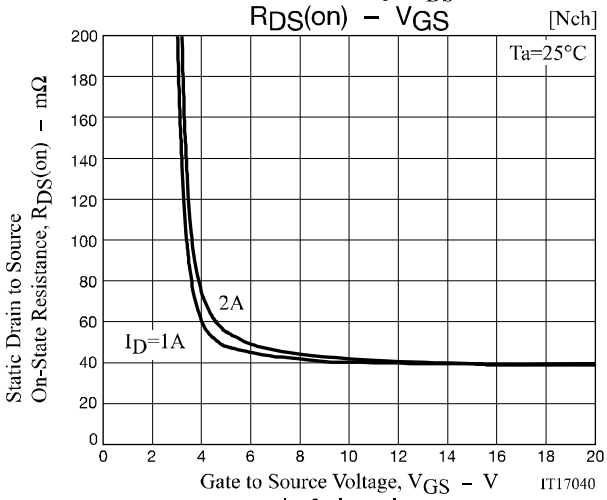
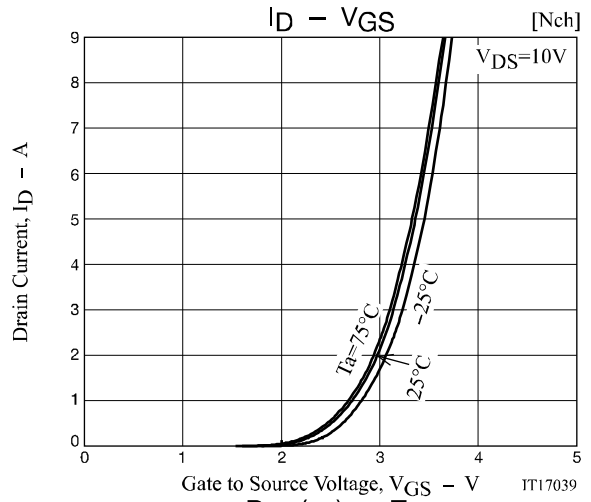
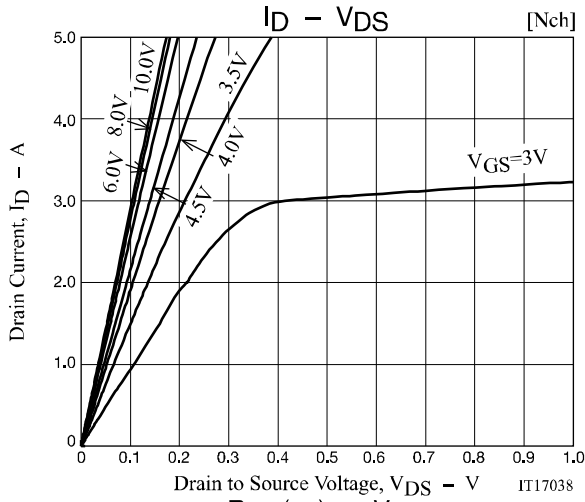

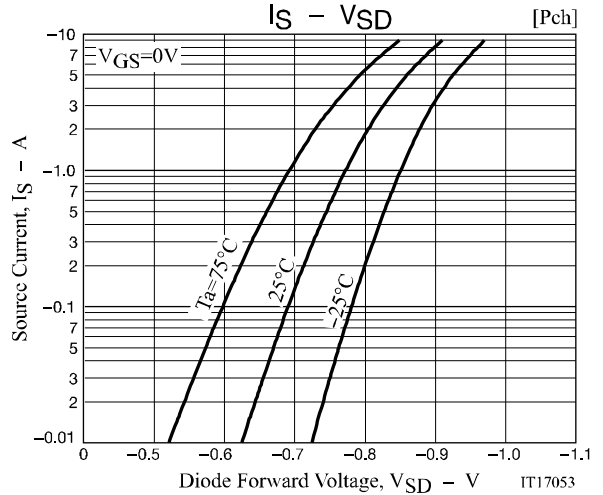
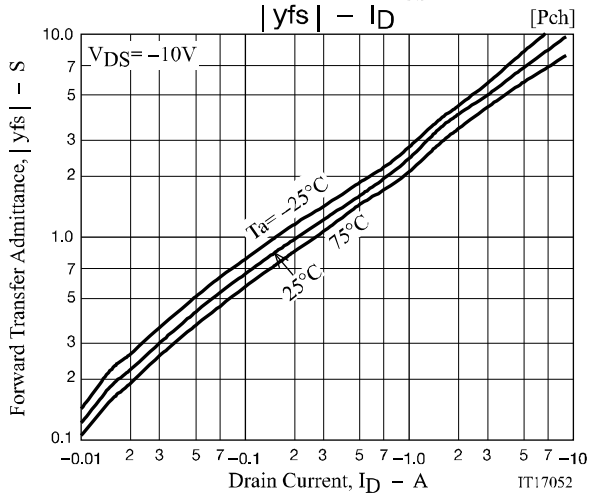
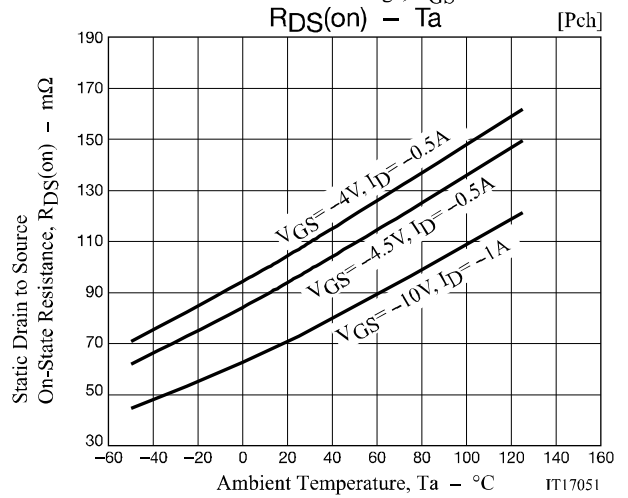
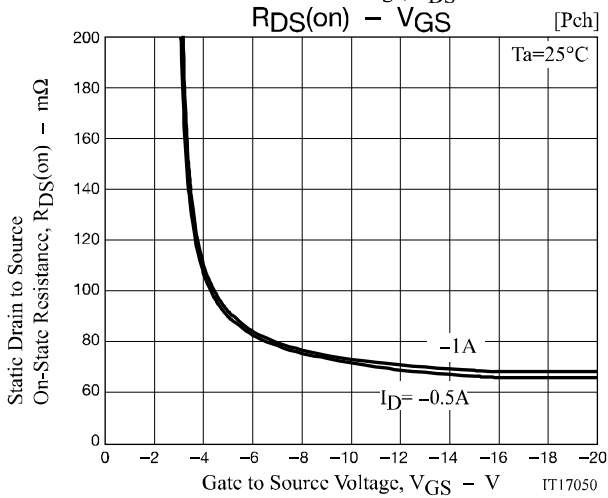
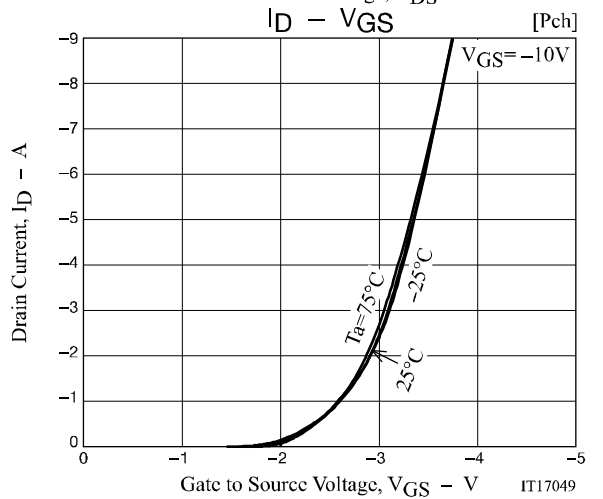
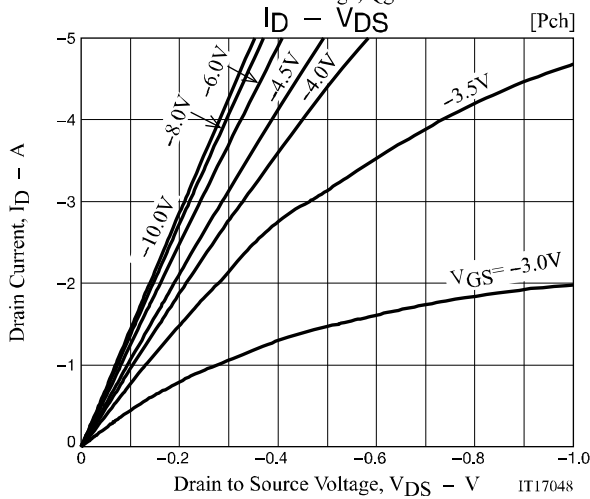
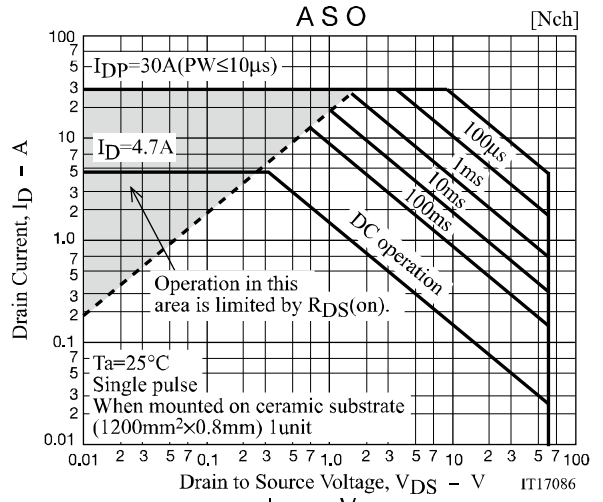
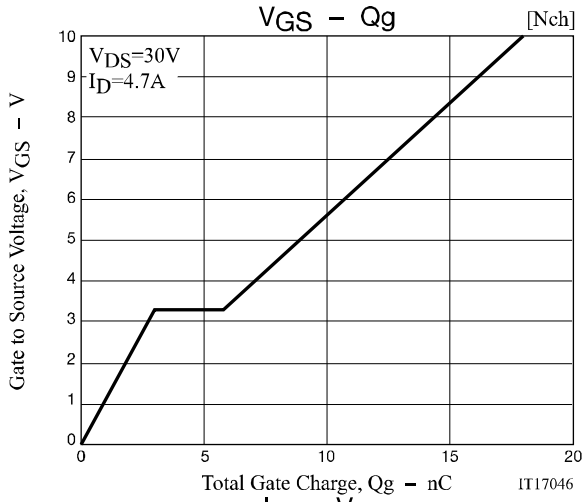

ECH8690

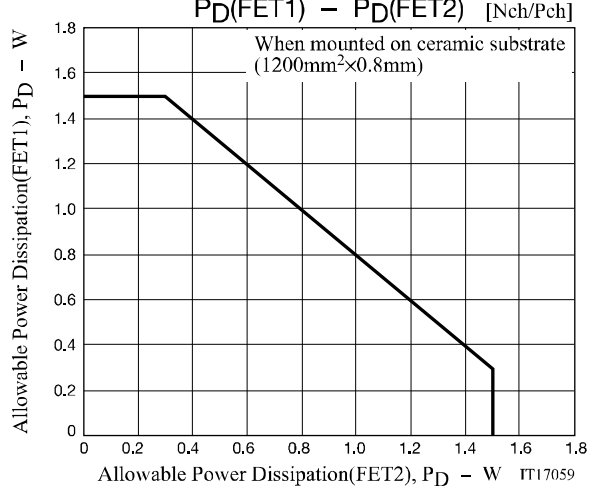
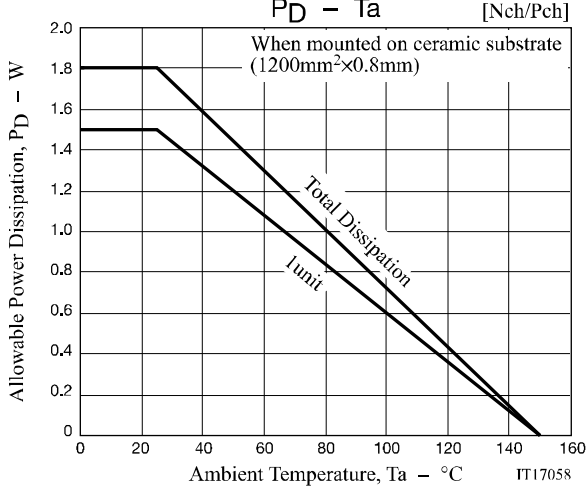
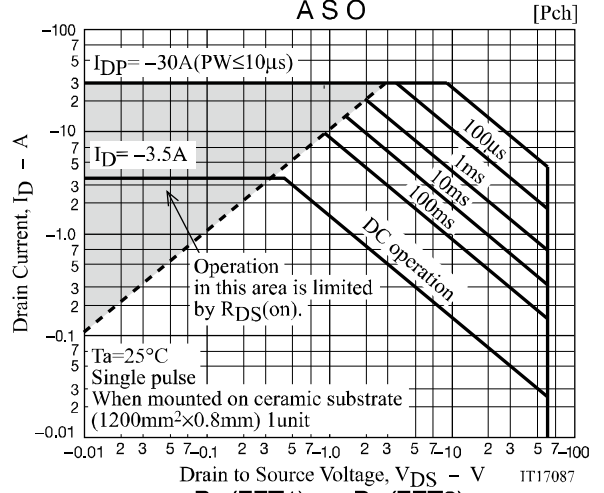
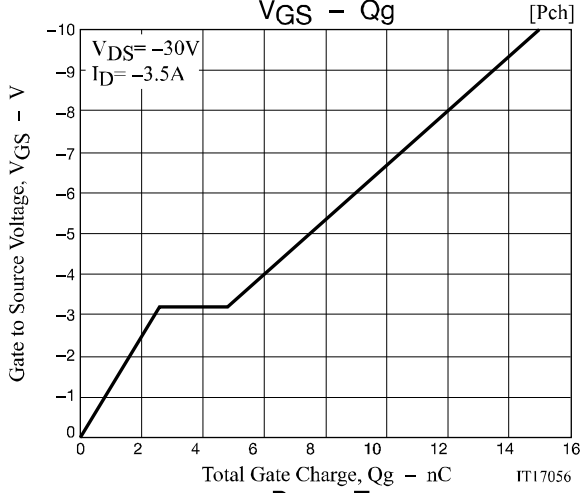
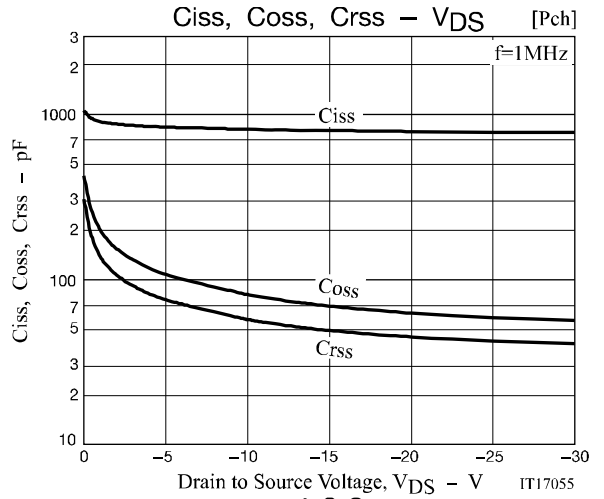
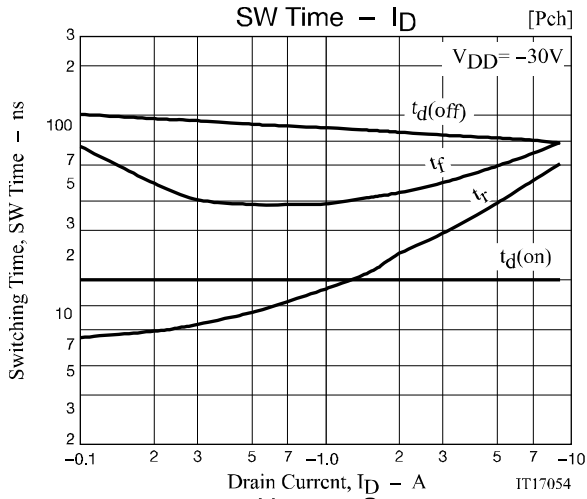

ECH8690

Outline Drawing

ECH8690-TL-H

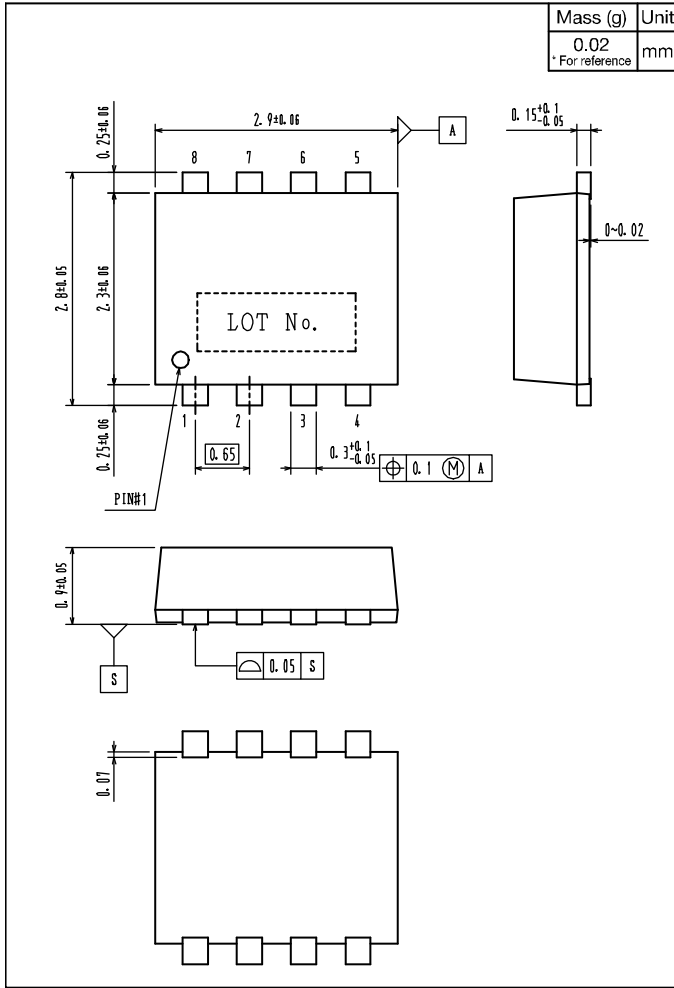

Land Pattern Example

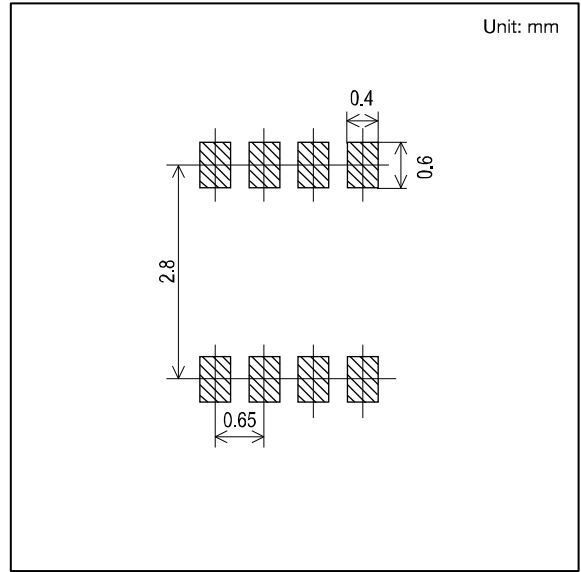

Note on usage : Since the ECH8690 is a MOSFET product, please avoid using this device in the vicinity of highly charged objects.

ON Semiconductor and the ON logo are registered trademarks of Semiconductor Components Industries, LLC (SCILLC). SCILLC owns the rights to a number of patents, trademarks, copyrights, trade secrets, and other intellectual property. A listing of SCILLC's product/patent coverage may be accessed at www.onsemi.com/site/pdf/Patent-Marking.pdf. SCILLC reserves the right to make changes without further notice to any products herein. SCILLC makes no warranty, representation or guarantee regarding the suitability of its products for any particular purpose, nor does SCILLC assume any liability arising out of the application or use of any product or circuit, and specifically disclaims any and all liability, including without limitation special, consequential or incidental damages. "Typical" parameters which may be provided in SCILLC data sheets and/or specifications can and do vary in different applications and actual performance may vary over time. All operating parameters, including "Typicals" must be validated for each customer application by customer's technical experts. SCILLC does not convey any license under its patent rights nor the rights of others. SCILLC products are not designed, intended, or authorized for use as components in systems intended for surgical implant into the body, or other applications intended to support or sustain life, or for any other application in which the failure of the SCILLC product could create a situation where personal injury or death may occur. Should Buyer purchase or use SCILLC products for any such unintended or unauthorized application, Buyer shall indemnify and hold SCILLC and its officers, employees, subsidiaries, affiliates, and distributors harmless against all claims, costs, damages, and expenses, and reasonable attorney fees arising out of, directly or indirectly, any claim of personal injury or death associated with such unintended or unauthorized use, even if such claim alleges that SCILLC was negligent regarding the design or manufacture of the part. SCILLC is an Equal Opportunity/Affirmative Action Employer. This literature is subject to all applicable copyright laws and is not for resale in any manner.



Компания «ЭлектроПласт» предлагает заключение долгосрочных отношений при поставках импортных электронных компонентов на взаимовыгодных условиях!

Наши преимущества:

- Оперативные поставки широкого спектра электронных компонентов отечественного и импортного производства напрямую от производителей и с крупнейших мировых складов;
- Поставка более 17-ти миллионов наименований электронных компонентов;
- Поставка сложных, дефицитных, либо снятых с производства позиций;
- Оперативные сроки поставки под заказ (от 5 рабочих дней);
- Экспресс доставка в любую точку России;
- Техническая поддержка проекта, помощь в подборе аналогов, поставка прототипов;
- Система менеджмента качества сертифицирована по Международному стандарту ISO 9001;
- Лицензия ФСБ на осуществление работ с использованием сведений, составляющих государственную тайну;
- Поставка специализированных компонентов (Xilinx, Altera, Analog Devices, Intersil, Interpoint, Microsemi, Aeroflex, Peregrine, Syfer, Eurofarad, Texas Instrument, Miteq, Cobham, E2V, MA-COM, Hittite, Mini-Circuits, General Dynamics и др.);

Помимо этого, одним из направлений компании «ЭлектроПласт» является направление «Источники питания». Мы предлагаем Вам помощь Конструкторского отдела:

- Подбор оптимального решения, техническое обоснование при выборе компонента;
- Подбор аналогов;
- Консультации по применению компонента;
- Поставка образцов и прототипов;
- Техническая поддержка проекта;
- Защита от снятия компонента с производства.



Как с нами связаться

Телефон: 8 (812) 309 58 32 (многоканальный)

Факс: 8 (812) 320-02-42

Электронная почта: org@eplast1.ru

Адрес: 198099, г. Санкт-Петербург, ул. Калинина, дом 2, корпус 4, литера А.