

Power Relay G7J

CSM_G7J_DS_E_5_3

A High-capacity, High-dielectric-strength, Multi-pole Relay Used Like a Contactor

- Miniature hinge for maximum switching power for motor loads as well as resistive and inductive loads.
- No contact chattering for momentary voltage drops up to 50% of rated voltage.
- Withstanding more than 4 kV between contacts that are different in polarity and between the coil and contacts.
- Flame-resistant materials (UL94V-0-qualifying) used for all insulation material.
- Standard models approved by UL and CSA.



For the most recent information on models that have been certified for safety standards, refer to your OMRON website.

Refer to *Safety Precautions for All Relays*.

Model Number Structure

Model Number Legend

G7J - 1 - 2 - 3

1. Contact Form

4A: 4PST-NO
3A1B: 3PST-NO/SPST-NC
2A2B: DPST-NO/DPST-NC

2. Terminal Shape

P: PCB terminals
B: Screw terminals
T: Quick-connect terminals (#250 terminal)

3. Contact Structure

Z: Bifurcated contact
None: Single contact

Note: For bifurcated contact type, output is 1NO (4PST-NO) or 1NC (3PST-NO/SPST-NC).

Ordering Information

List of Models

| Mounting type | Contact form | PCB terminals | Screw terminals | Quick-connect terminals |
|-------------------------|-----------------|-------------------------|-------------------------|-------------------------|
| | | | | |
| PCB mounting | 4PST-NO | G7J-4A-P, G7J-4A-PZ | --- | --- |
| | 3PST-NO/SPST-NC | G7J-3A1B-P, G7J-3A1B-PZ | --- | --- |
| | DPST-NO/DPST-NC | G7J-2A2B-P | --- | --- |
| W-bracket (see note) | 4PST-NO | --- | G7J-4A-B | G7J-4A-T, G7J-4A-TZ |
| | 3PST-NO/SPST-NC | --- | G7J-3A1B-B, G7J-3A1B-BZ | G7J-3A1B-T, G7J-3A1B-TZ |
| | DPST-NO/DPST-NC | --- | G7J-2A2B-B | G7J-2A2B-T |

Note: These Relays need a W-bracket (sold separately) for mounting. When ordering specify the voltage.
Example: G7J-4A-P 240 VAC
 Rated coil voltage

PCB Terminals

| Contact form | Model | Rated voltage |
|---------------------|------------|--|
| 4PST-NO | G7J-4A-P | 24, 50, 100/120, 200/240 VAC 12, 24, 48, 100 VDC |
| 3PST-NO/ SPST-NC | G7J-3A1B-P | 24, 50, 100/120, 200/240 VAC 12, 24, 48, 100 VDC |
| DPST-NO/DPST- NC | G7J-2A2B-P | 24, 50, 100/120, 200/240 VAC 12, 24, 48, 100 VDC |

PCB Terminals (Bifurcated Contact)

| Contact form | Model | Rated voltage |
|---------------------|-------------|---------------------------|
| 4PST-NO | G7J-4A-PZ | 200/240 VAC 24 VDC |
| 3PST-NO/ SPST-NC | G7J-3A1B-PZ | 200/240 VAC 12, 24 VDC |

W-bracket Screw Terminals

| Contact form | Model | Rated voltage |
|---------------------|------------|--|
| 4PST-NO | G7J-4A-B | 24, 50, 100/120, 200/240 VAC 12, 24, 48, 100 VDC |
| 3PST-NO/ SPST-NC | G7J-3A1B-B | 24, 50, 100/120, 200/240 VAC 12, 24, 48, 100 VDC |
| DPST-NO/ DPST-NC | G7J-2A2B-B | 24, 50, 100/120, 200/240 VAC 12, 24, 48, 100 VDC |

■ Accessories (Order Separately)

| Name | Model | Applicable Relay |
|-----------|----------------|--|
| W-bracket | R99-04 for G5F | G7J-4A-B G7J-3A1B-B(Z) G7J-2A2B-B G7J-4A-T(Z) G7J-3A1B-T G7J-2A2B-T |

Application Examples

- Compressors for air conditioners and heater switching controllers.
- Switching controllers for power tools or motors.
- Lamp controls, motor drivers, and power supply switching controllers in copy machines, facsimile machines, and other office equipment.
- Power controllers for packers or food processing equipment.
- Power controllers for inverters.

Screw Terminals (Bifurcated Contact)

| Contact form | Model | Rated voltage |
|---------------------|-------------|---------------------------|
| 3PST-NO/ SPST-NC | G7J-3A1B-BZ | 200/240 VAC 12, 24 VDC |

W-bracket Tab Terminals

| Contact form | Model | Rated voltage |
|---------------------|------------|--|
| 4PST-NO | G7J-4A-T | 24, 50, 100/120, 200/240 VAC 12, 24, 48, 100 VDC |
| 3PST-NO/ SPST-NC | G7J-3A1B-T | 24, 50, 100/120, 200/240 VAC 12, 24, 48, 100 VDC |
| DPST-NO/ DPST-NC | G7J-2A2B-T | 24, 50, 100/120, 200/240 VAC 12, 24, 48, 100 VDC |

W-bracket Tab Terminals (Bifurcated Contact)

| Contact form | Model | Rated voltage |
|--------------|-----------|---------------|
| 4PST-NO | G7J-4A-TZ | 200/240 VAC |

Consult your OMRON representative for details on models not mentioned in this document.

Specifications

■ Coil Ratings

| | Rated voltage | Rated current | Coil resistance | Must-operate voltage | Must-release voltage | Max. voltage | Power consumption |
|----|----------------|---------------|-----------------|---------------------------|---------------------------|-----------------------|-----------------------|
| AC | 24 VAC | 75 mA | --- | 75% max. of rated voltage | 15% min. of rated voltage | 110% of rated voltage | Approx. 1.8 to 2.6 VA |
| | 50 VAC | 36 mA | --- | | | | |
| | 100 to 120 VAC | 18 to 21.6 mA | --- | | | | |
| | 200 to 240 VDC | 9 to 10.8 mA | --- | | | | |
| DC | 12 VDC | 167 mA | 72 Ω | | 10% min. of rated voltage | | Approx. 2.0 W |
| | 24 VDC | 83 mA | 288 Ω | | | | |
| | 48 VDC | 42 mA | 1,150 Ω | | | | |
| | 100 VDC | 20 mA | 5,000 Ω | | | | |

- Note:** 1. The rated current and coil resistance are measured at a coil temperature of 23°C with tolerances of +15%/–20% for AC rated current and ±15% for DC coil resistance. (The values given for AC rated current apply at 50 Hz or 60 Hz.)
 2. Performance characteristic data are measured at a coil temperature of 23°C.
 3. The maximum voltage is one that is applicable to the Relay coil at 23°C.

■ Contact Ratings

| Item | Resistive load ($\cos \phi = 1$) | Inductive load ($\cos \phi = 0.4$) | Resistive load |
|------------------------|--|--------------------------------------|---|
| Contact mechanism | Double break | | |
| Contact material | Ag alloy | | |
| Rated load | NO: 25 A at 220 VAC (24 A at 230 VAC) NC: 8 A at 220 VAC (7.5 A at 230 VAC) | | NO: 25 A at 30 VDC NC: 8 A at 30 VDC |
| Rated carry current | NO: 25 A (1 A) NC: 8 A (1 A) | | |
| Max. switching voltage | 250 VAC | | 125 VDC |
| Max. switching current | NO: 25 A (1 A) NC: 8 A (1 A) | | |

Note: The values in parentheses indicate values for a bifurcated contact.

■ Characteristics

| | |
|------------------------------------|---|
| Contact resistance (see note 2) | 100 mΩ max. |
| Operate time (see note 3) | 50 ms max. |
| Release time (see note 3) | 50 ms max. |
| Max. operating frequency | Mechanical: 1,800 operations/hr Electrical: 1,800 operations/hr |
| Insulation resistance (see note 4) | 1,000 MΩ min. (at 500 VDC) |
| Dielectric strength | 4,000 VAC, 50/60 Hz for 1 min between coil and contacts 4,000 VAC, 50/60 Hz for 1 min between contacts of different polarity 2,000 VAC, 50/60 Hz for 1 min between contacts of same polarity |
| Impulse withstand voltage | 10,000 V between coil and contact (with 1.2 x 50 μs impulse wave) |
| Vibration resistance | Destruction: 10 to 55 to 10 Hz, 0.75-mm single amplitude (1.5-mm double amplitude) Malfunction: NO:10 to 55 to 10 Hz, 0.75-mm single amplitude (1.5-mm double amplitude) NC:10 to 26 to 10 Hz, 0.75-mm single amplitude (1.5-mm double amplitude) |
| Shock resistance | Destruction: 1,000 m/s ² Malfunction: NO:100 m/s ² NC:20 m/s ² |
| Endurance | Mechanical: 1,000,000 operations min. (at 1,800 operations/hr) Electrical: 100,000 operations min. (at 1,800 operations/hr) (see note 5) |
| Error rate (see note 6) | 100 mA at 24 VDC (bifurcated contact: 24 VDC 10 mA) |
| Ambient temperature | Operating: –25°C to 60°C (with no icing or condensation) |
| Ambient humidity | Operating: 5% to 85% |
| Weight | PCB terminal: approx. 140 g Screw terminal: approx. 165 g Quick-connect terminal: approx. 140 g |

- Note:**
1. The above values are all initial values.
 2. The contact resistance was measured with 1 A at 5 VDC using the voltage drop method.
 3. The operate and the release times were measured with the rated voltage imposed with any contact bounce ignored at an ambient temperature of 23°C.
 4. The insulation resistance was measured with a 500-VDC megger applied to the same places as those used for checking the dielectric strength.
 5. The electrical endurance was measured at an ambient temperature of 23°C.
 6. This value was measured at a switching frequency of 60 operations per minute.

■ Approved Standards

The G7J satisfies the following international standards. Approval for some international markings and symbols are still pending, however, and information on them will be added when they are approved.

UL (File No. E41643)

CSA (File No. LR35535)

| Coil ratings | Contact ratings | | Number of test operations |
|-------------------------------|-----------------|------------------------------|---------------------------|
| 24 to 265 VAC 6 to 110 VDC | NO contact | 25 A 277 VAC, Resistive | 30,000 |
| | | 25 A 120 VAC, General Use | |
| | | 25 A 277 VAC, General Use | |
| | | 25 A 240 VAC, General Use | 100,000 |
| | | 1.5 kW 120 VAC, Tungsten | 6,000 |
| | | 1.5 hp 120 VAC | 1,000 |
| | | 3 hp 240/265/277 VAC | 30,000 |
| | | 3-phase 3 hp 240/265/277 VAC | |
| | | 3-phase 5 hp 240/265/277 VAC | |
| | | 20FLA/120LRA 120 VAC | 25,000 |
| | | 17FLA/102LRA 277 VAC | |
| | | TV-10 120 VAC | |
| | | 25 A 30 VDC, Resistive | 30,000 |
| | | *1 A 277 VAC, General Use | 6,000 |
| | NC contact | 8 A 277 VAC, Resistive | 30,000 |
| | | 8 A 120 VAC, General Use | |
| | | 8 A 277 VAC, General Use | |
| | | 8 A 30 VDC, Resistive | |
| | | *1 A 277 VAC, General Use | 6,000 |

Note: *These ratings are bifurcated contact ratings.

Reference

UL approval: UL508 for industrial control devices

CSA approval: CSA C22.2 No. 14 for industrial control devices

VDE (File No. 5381UG)

| Model | Coil ratings | Contact ratings | |
|-------------------|------------------------------------|-------------------------------|------------------------------|
| | | NO contact | NC contact |
| G7J-4A-B(P) (T) | 6, 12, 24, 48, 100 VDC | 25 A 240 VAC $\cos\phi = 0.4$ | 8 A 240 VAC $\cos\phi = 0.4$ |
| G7J-2A2B(P) (T) | 24, 50, 100 to 120, 200 to 240 VAC | 25 A 240 VAC $\cos\phi = 1$ | 8 A 240 VAC $\cos\phi = 1$ |
| G7J-3A1B-B(P) (T) | | 25 A 30 VDC $L/R \geq 1$ | 8 A 30 VDC $L/R \geq 1$ |

Note: Add the suffix "-KM" to the model number when ordering.

Reference

VDE approval: EN60255-1-00: 1997

EN60255-23: 1996

KEMA (File No. 2001291.02)

| Model | Coil ratings | Contact ratings |
|--|--|--|
| | | NO contact |
| G7J-4A-B(P) (T) (Z) G7J-2A2B(P) (T) | 200 to 240 VAC | Class AC1: 25 A at 220 VAC 11.5 A at 380 to 480 VAC |
| G7J-3A1B-B(P) (T) (Z) | 6, 12, 24, 48, 100 VDC 24, 50, 100 to 120, 200 to 240 VAC | Class AC3: 11.5 A at 220 VAC and 8.5 A at 380 to 480 VAC *Class AC1: 1 A at 220 VAC |

Note: Add the suffix “-KM” to the model number when ordering.

*This rating is the bifurcated contact rating.

Reference

KEMA approval: EN60947-4-1 for contacts

Engineering Data

■ **Maximum Switching Power**

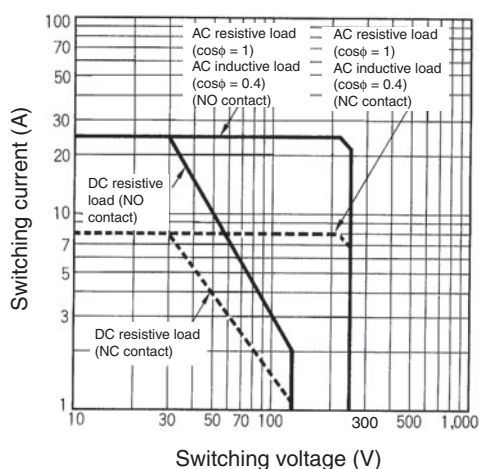

■ **Endurance**

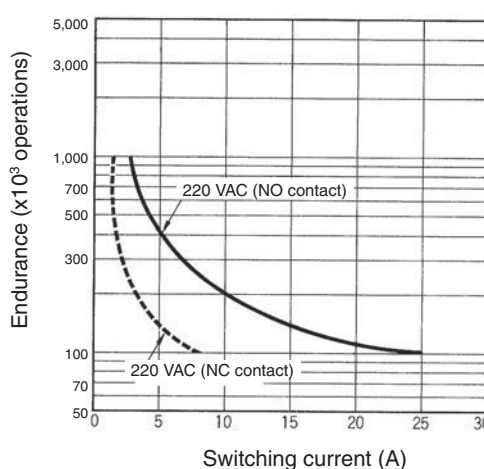

■ **Malfunctioning Shock**

G7J-2A2B

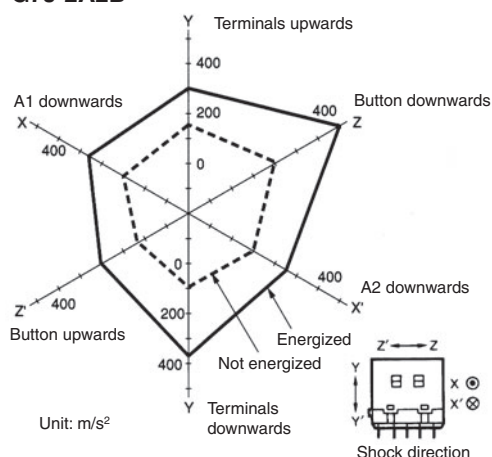

Number of samples: 5

Measurement conditions: Increase and decrease the specified shock gradually imposed in ±X, ±Y, and ±Z directions three times each with the Relay energized and not energized to check the shock values that cause the Relay to malfunction.

Criteria: There must not be any contact separation for 1 ms or greater with a shock of 100 m/s² imposed when the coil is energized or with a shock of 20 m/s² when the coil is not energized.

■ Ambient Temperature vs. Must-operate and Must-release Voltage

G7J 100 to 120 VAC

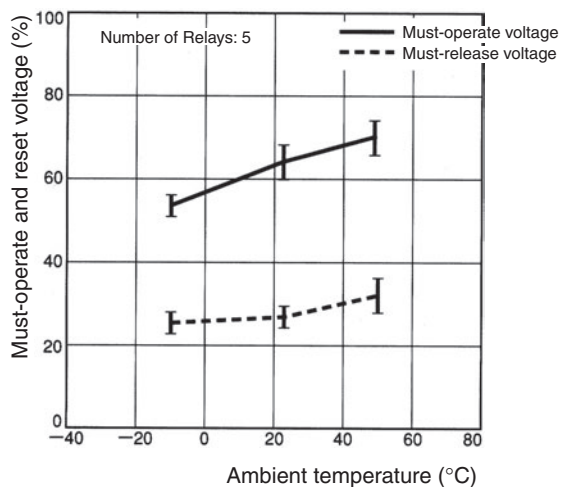

■ Ambient Temperature vs. Coil Temperature Rise

G7J-4A 100 to 120 VAC

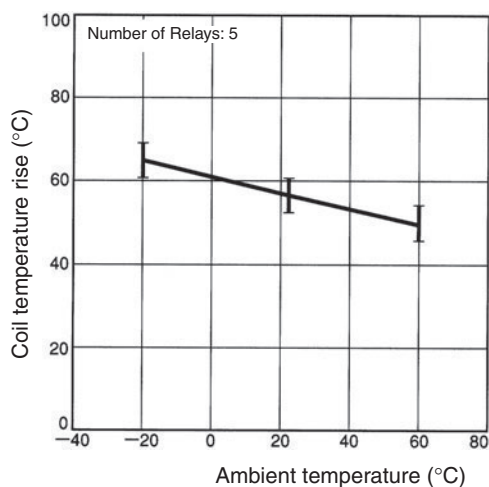

G7J 24 VDC

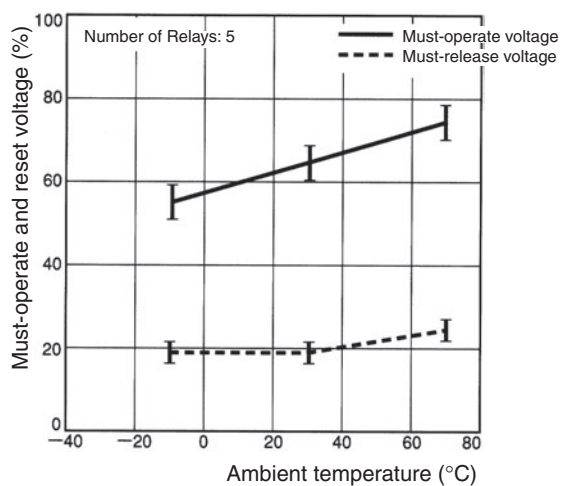

G7J-4A 24 VDC

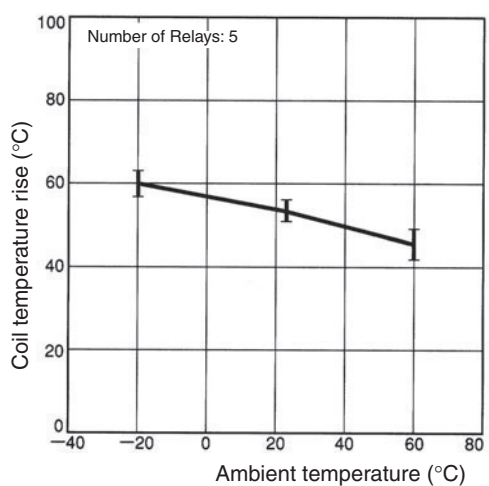

Motor Load

| | |
|-----------|--|
| Item | G7J-4A-P, G7J-3A1B-P, G7J-4A-B, G7J-3A1B-B, G7J-4A-T, G7J-3A1B-T |
| Load | 3φ, 220 VAC, 2.7 kW (with a inrush current of 78 A and a breaking current of 13 A) |
| Endurance | Electrical: 100,000 operations min. |

Dimensions

Note: All units are in millimeters unless otherwise indicated.

Screw Terminals with W-bracket

G7J-4A-B, G7J-3A1B-B, G7J-3A1B-BZ, G7J-2A2B-B

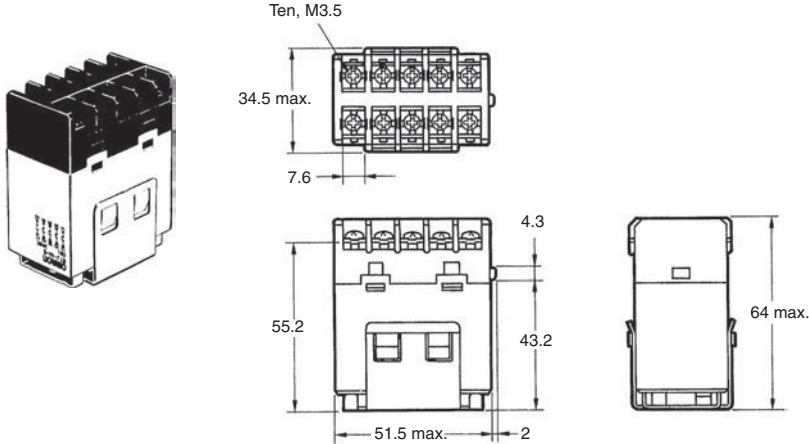

Mounting Holes

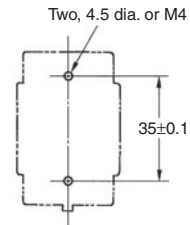

Quick-connect Terminals with W-bracket

G7J-4A-T, G7J-4A-TZ, G7J-3A1B-T, G7J-2A2B-T

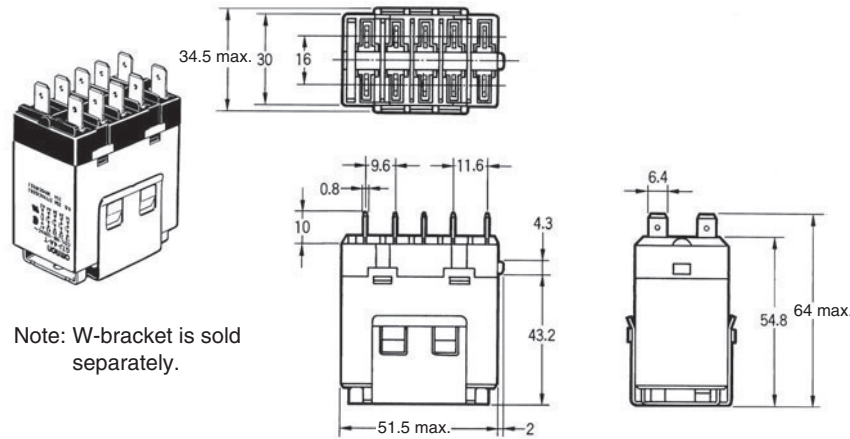

Mounting Holes

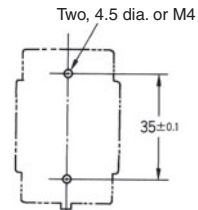

Note: W-bracket is sold separately.

PCB Terminals with PCB Mounting

G7J-4A-P, G7J-4A-PZ, G7J-3A1B-P, G7J-3A1B-PZ, G7J-2A2B-P

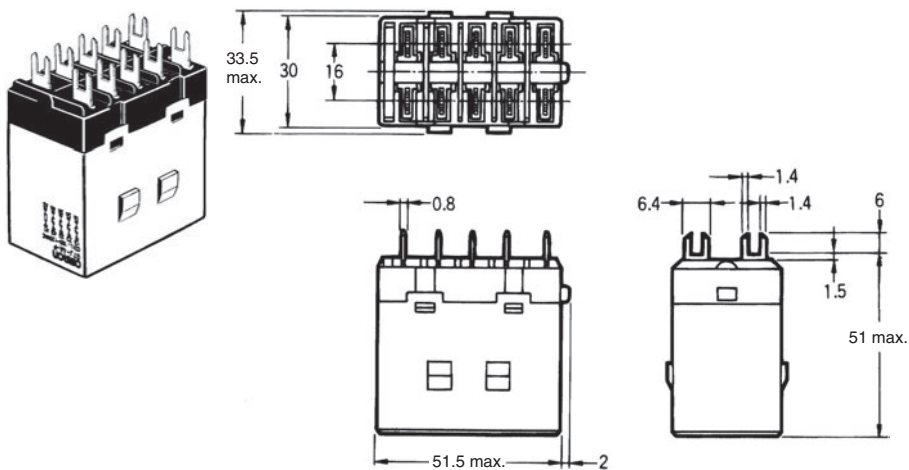

Mounting Dimensions

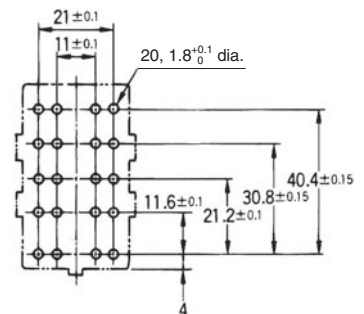

■ Terminal Arrangement/Internal Connections

G7J-4A-P
G7J-4A-B
G7J-4A-T

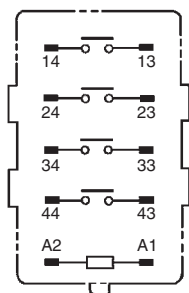

G7J-3A1B-P
G7J-3A1B-B
G7J-3A1B-T

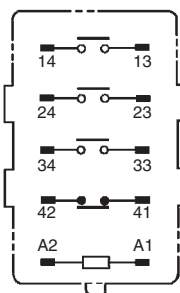

The coil has no polarity.

G7J-2A2B-P
G7J-2A2B-B
G7J-2A2B-T

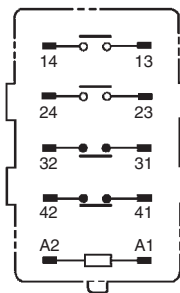

Note: Terminals 43 and 44 of the G7J-4A-P(T) and contacts 41 and 42 of the G7J-3A1B-P(B) are bifurcated contacts.

■ Accessories (Order Separately)

R99-04 W-bracket (for G5F)

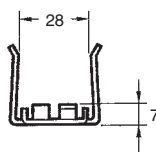
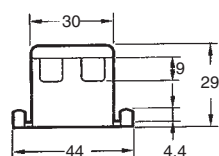
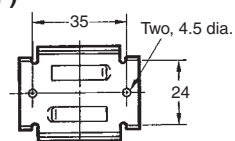
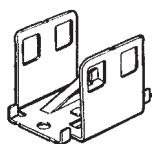

Mounting Holes

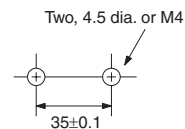

Safety Precautions

Refer to *Safety Precautions for All Relays*.

■ Correct Use

Installation

PCB Terminal-equipped Relays weigh approximately 140 g. Be sure that the PCB is strong enough to support them. We recommend dual-side through-hole PCBs to reduce solder cracking from heat stress.

Mount the G7J with its test button facing downwards. The Relay may malfunction due to shock if the test button faces upwards. Be careful not to press the test button by mistake because the contacts will go ON if the test button is pressed.

If the normal mounting direction is not used, carbides or powder from contact abrasion that results from load switching will accumulate inside the Relay. If the Relay is used past its endurance in this state, insulation failure between circuits of different polarity or Relay burning may occur.

Be sure to use the test button for test purposes only. The test button is used for Relay circuit tests, such as a circuit continuity test. Do not attempt to switch the load with the test button.

If a voltage is applied to the coil, the test button will retract in an ON state (i.e., an excited state).

Micro Loads

The G7J is used for switching power loads, such as motor, transformer, solenoid, lamp, and heater loads. Do not use the G7J for switching minute loads, such as signals. Use a Relay with a bifurcated contact construction for switching micro loads, in which case, however, only SPST-NO or SPST-NC output is obtained.

Soldering PCB Terminals

Be sure to solder the PCB terminals manually only. In the case of automatic soldering, some flux may stick to the test button and the G7J. As a result, the G7J may malfunction.

The G7J is not of enclosed construction. Therefore, do not wash the G7J with water or any detergent.

Connecting

Refer to the following diagram when connecting a wire with a screw terminal to the G7J.

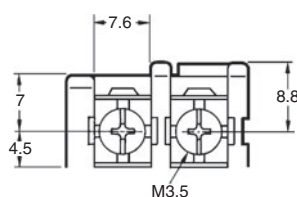

Allow suitable slack on leads when wiring, and do not subject the terminals to excessive force.

Tighten the terminal screws with torque 0.78 to 1.18 N·m. Loose screws result in disconnection of lead wire, malfunction or fire.

Faston Tabs

Do not impose excessive external force on the G7J in the horizontal or vertical directions when inserting the G7J to the Faston receptacle or pulling the G7J out from the Faston receptacle. Do not attempt to insert or pull out more than one G7J Unit together.

Do not solder the tab terminals.

| Terminal | Receptacle | Housing |
|-------------------------------------|---|--|
| #250 terminal (6.35 mm in width) | AMP170333-1 (170327-1) AMP170334-1 (170328-1) AMP170335-1 (170329-1) | AMP172076-1: natural AMP172076-4: yellow AMP172076-5: green AMP172076-6: blue |

Note: Numbers in parentheses are for air feed use.

Operating Coil

Internal Connections of Coils

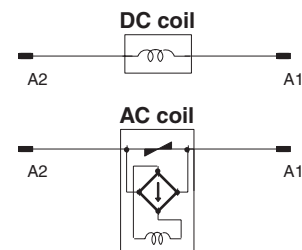

If a transistor drives the G7J, check the leakage current, and connect a bleeder resistor if necessary.

The AC coil is provided with a built-in full-wave rectifier. If a triac, such as an SSR, drives the G7J, the G7J may not release. Use the Power MOS FET Relay in this case.

ALL DIMENSIONS SHOWN ARE IN MILLIMETERS.

To convert millimeters into inches, multiply by 0.03937. To convert grams into ounces, multiply by 0.03527.

In the interest of product improvement, specifications are subject to change without notice.

Read and Understand This Catalog

Please read and understand this catalog before purchasing the products. Please consult your OMRON representative if you have any questions or comments.

Warranty and Limitations of Liability

WARRANTY

OMRON's exclusive warranty is that the products are free from defects in materials and workmanship for a period of one year (or other period if specified) from date of sale by OMRON.

OMRON MAKES NO WARRANTY OR REPRESENTATION, EXPRESS OR IMPLIED, REGARDING NON-INFRINGEMENT, MERCHANTABILITY, OR FITNESS FOR PARTICULAR PURPOSE OF THE PRODUCTS. ANY BUYER OR USER ACKNOWLEDGES THAT THE BUYER OR USER ALONE HAS DETERMINED THAT THE PRODUCTS WILL SUITABLY MEET THE REQUIREMENTS OF THEIR INTENDED USE. OMRON DISCLAIMS ALL OTHER WARRANTIES, EXPRESS OR IMPLIED.

LIMITATIONS OF LIABILITY

OMRON SHALL NOT BE RESPONSIBLE FOR SPECIAL, INDIRECT, OR CONSEQUENTIAL DAMAGES, LOSS OF PROFITS OR COMMERCIAL LOSS IN ANY WAY CONNECTED WITH THE PRODUCTS, WHETHER SUCH CLAIM IS BASED ON CONTRACT, WARRANTY, NEGLIGENCE, OR STRICT LIABILITY.

In no event shall the responsibility of OMRON for any act exceed the individual price of the product on which liability is asserted.

IN NO EVENT SHALL OMRON BE RESPONSIBLE FOR WARRANTY, REPAIR, OR OTHER CLAIMS REGARDING THE PRODUCTS UNLESS OMRON'S ANALYSIS CONFIRMS THAT THE PRODUCTS WERE PROPERLY HANDLED, STORED, INSTALLED, AND MAINTAINED AND NOT SUBJECT TO CONTAMINATION, ABUSE, MISUSE, OR INAPPROPRIATE MODIFICATION OR REPAIR.

Application Considerations

SUITABILITY FOR USE

OMRON shall not be responsible for conformity with any standards, codes, or regulations that apply to the combination of products in the customer's application or use of the products.

At the customer's request, OMRON will provide applicable third party certification documents identifying ratings and limitations of use that apply to the products. This information by itself is not sufficient for a complete determination of the suitability of the products in combination with the end product, machine, system, or other application or use.

The following are some examples of applications for which particular attention must be given. This is not intended to be an exhaustive list of all possible uses of the products, nor is it intended to imply that the uses listed may be suitable for the products:

- Outdoor use, uses involving potential chemical contamination or electrical interference, or conditions or uses not described in this catalog.
- Nuclear energy control systems, combustion systems, railroad systems, aviation systems, medical equipment, amusement machines, vehicles, safety equipment, and installations subject to separate industry or government regulations.
- Systems, machines, and equipment that could present a risk to life or property.

Please know and observe all prohibitions of use applicable to the products.

NEVER USE THE PRODUCTS FOR AN APPLICATION INVOLVING SERIOUS RISK TO LIFE OR PROPERTY WITHOUT ENSURING THAT THE SYSTEM AS A WHOLE HAS BEEN DESIGNED TO ADDRESS THE RISKS, AND THAT THE OMRON PRODUCTS ARE PROPERLY RATED AND INSTALLED FOR THE INTENDED USE WITHIN THE OVERALL EQUIPMENT OR SYSTEM.

PROGRAMMABLE PRODUCTS

OMRON shall not be responsible for the user's programming of a programmable product, or any consequence thereof.

Disclaimers

CHANGE IN SPECIFICATIONS

Product specifications and accessories may be changed at any time based on improvements and other reasons.

It is our practice to change model numbers when published ratings or features are changed, or when significant construction changes are made. However, some specifications of the products may be changed without any notice. When in doubt, special model numbers may be assigned to fix or establish key specifications for your application on your request. Please consult with your OMRON representative at any time to confirm actual specifications of purchased products.

DIMENSIONS AND WEIGHTS

Dimensions and weights are nominal and are not to be used for manufacturing purposes, even when tolerances are shown.

PERFORMANCE DATA

Performance data given in this catalog is provided as a guide for the user in determining suitability and does not constitute a warranty. It may represent the result of OMRON's test conditions, and the users must correlate it to actual application requirements. Actual performance is subject to the OMRON Warranty and Limitations of Liability.

ERRORS AND OMISSIONS

The information in this document has been carefully checked and is believed to be accurate; however, no responsibility is assumed for clerical, typographical, or proofreading errors, or omissions.

2012.8

In the interest of product improvement, specifications are subject to change without notice.

OMRON Corporation
Industrial Automation Company

<http://www.ia.omron.com/>

(c)Copyright OMRON Corporation 2012 All Right Reserved.



Компания «ЭлектроПласт» предлагает заключение долгосрочных отношений при поставках импортных электронных компонентов на взаимовыгодных условиях!

Наши преимущества:

- Оперативные поставки широкого спектра электронных компонентов отечественного и импортного производства напрямую от производителей и с крупнейших мировых складов;
- Поставка более 17-ти миллионов наименований электронных компонентов;
- Поставка сложных, дефицитных, либо снятых с производства позиций;
- Оперативные сроки поставки под заказ (от 5 рабочих дней);
- Экспресс доставка в любую точку России;
- Техническая поддержка проекта, помощь в подборе аналогов, поставка прототипов;
- Система менеджмента качества сертифицирована по Международному стандарту ISO 9001;
- Лицензия ФСБ на осуществление работ с использованием сведений, составляющих государственную тайну;
- Поставка специализированных компонентов (Xilinx, Altera, Analog Devices, Intersil, Interpoint, Microsemi, Aeroflex, Peregrine, Syfer, Eurofarad, Texas Instrument, Miteq, Cobham, E2V, MA-COM, Hittite, Mini-Circuits, General Dynamics и др.);

Помимо этого, одним из направлений компании «ЭлектроПласт» является направление «Источники питания». Мы предлагаем Вам помощь Конструкторского отдела:

- Подбор оптимального решения, техническое обоснование при выборе компонента;
- Подбор аналогов;
- Консультации по применению компонента;
- Поставка образцов и прототипов;
- Техническая поддержка проекта;
- Защита от снятия компонента с производства.



Как с нами связаться

Телефон: 8 (812) 309 58 32 (многоканальный)

Факс: 8 (812) 320-02-42

Электронная почта: org@eplast1.ru

Адрес: 198099, г. Санкт-Петербург, ул. Калинина, дом 2, корпус 4, литера А.