

# X2PT IGBT Module

advanced

 $V_{CES} = 1200\text{ V}$   
 $I_{C25} = 312\text{ A}$   
 $V_{CE(sat)} = 1.7\text{ V}$ 

6-Pack + NTC + Shunt

**Part number**

MIXG240W1200PZTEH

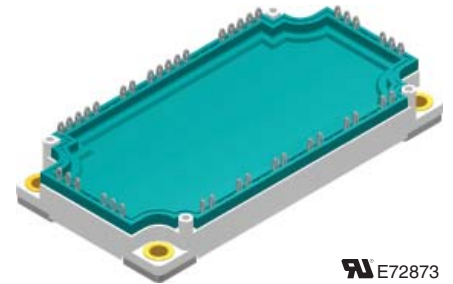

E72873

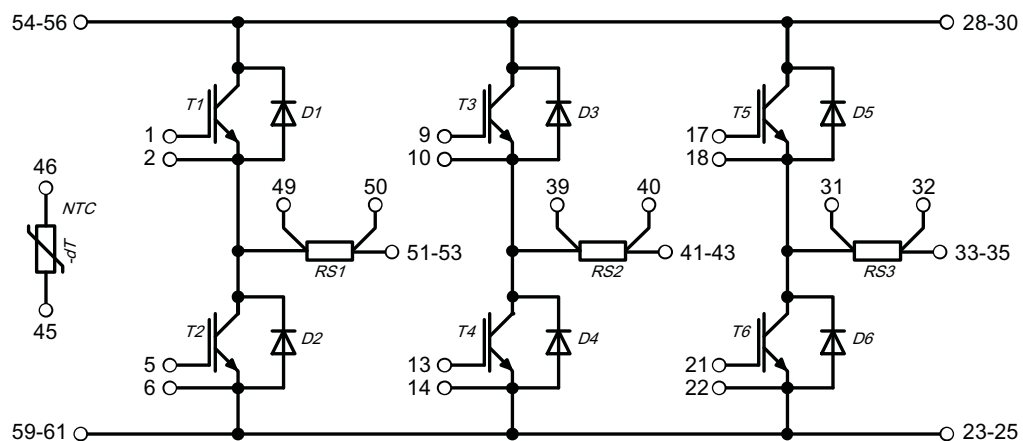
**Features / Advantages:**

- X2PT - 2nd generation Xtreme light Punch Through
- $T_{vjm} = 175^{\circ}\text{C}$
- Easy paralleling due to the positive temperature coefficient of the on-state voltage
- Rugged X2PT design results in:
  - short circuit rated for 10  $\mu\text{sec.}$
  - very low gate charge
  - low EMI
  - square RBSOA @ 2x  $I_c$
- Low  $V_{CE(sat)}$  and low thermal resistance
- SONIC2™ diode
  - fast and soft reverse recovery
  - low operating forward voltage

**Applications:**

- AC motor drives
- Solar inverter
- Medical equipment
- Uninterruptible power supply
- Air-conditioning systems
- Welding equipment
- Switched-mode and resonant-mode power supplies
- Inductive heating, cookers
- Pumps, Fans

**Package: E3-Pack**

- Isolation Voltage: 4300 V~
- Industry standard outline
- RoHS compliant
- Base plate: Copper internally DCB isolated
- Advanced power cycling
- PressFit pins

**Option:**

- Phase Change Material printed on base plate

**Terms & Conditions of usage**

The data contained in this product data sheet is exclusively intended for technically trained staff. The user will have to evaluate the suitability of the product for the intended application and the completeness of the product data with respect to his application. The specifications of our components may not be considered as an assurance of component characteristics. The information in the valid application- and assembly notes must be considered. Should you require product information in excess of the data given in this product data sheet or which concerns the specific application of your product, please contact your local sales office.

Due to technical requirements our product may contain dangerous substances. For information on the types in question please contact your local sales office.

Should you intend to use the product in aviation, in health or life endangering or life support applications, please notify. For any such application we urgently recommend

- to perform joint risk and quality assessments;

- the conclusion of quality agreements;

- to establish joint measures of an ongoing product survey, and that we may make delivery dependent on the realization of any such measures.

IXYS reserves the right to change limits, test conditions and dimensions.

20180403a

Inverter IGBT T1 - T6				Ratings		
Symbol	Definitions	Conditions	min.	typ.	max.	
$V_{CES}$	collector emitter voltage	$I_R = 500 \mu A$	$T_{VJ} = 25^\circ C$	1200		V
$V_{GES}$	max. DC gate voltage			-20	+20	V
$V_{GEM}$	max. transient gate emitter voltage			-30	+30	V
$I_{C25}$	collector current		$T_C = 25^\circ C$		312	A
$I_{C80}$			$T_C = 80^\circ C$		233	A
$I_{C100}$			$T_C = 100^\circ C$		200	A
$P_{tot}$	total power dissipation		$T_C = 25^\circ C$		938	W
$V_{CE(sat)}$	collector emitter saturation voltage on die level	$I_C = 200 A; V_{GE} = 15 V$	$T_{VJ} = 25^\circ C$ $T_{VJ} = 150^\circ C$	1.7 2	2	V V
$V_{GE(th)}$	gate emitter threshold voltage	$I_C = 8 mA; V_{GE} = V_{GE}$	$T_{VJ} = 25^\circ C$	6.0	7.5	V
$I_{CES}$	collector emitter leakage current (includes diode reverse current)	$V_{CE} = V_{CES}; V_{GE} = 0 V$	$T_{VJ} = 25^\circ C$ $T_{VJ} = 150^\circ C$	2.5	0.15	mA mA
$I_{GES}$	gate emitter leakage current	$V_{GE} = \pm 20 V$			500	nA
$R_G$	internal gate resistance			6.5		$\Omega$
$C_{iss}$	input capacitance	} $V_{CE} = 100 V; V_{GS} = 0 V; f = 1 MHz$		10.6		nF
$C_{oss}$	output capacitance					pF
$C_{rss}$	reverse transfer (Miller) capacitance					pF
$Q_g$	total gate charge	} $V_{CE} = 600 V; V_{GE} = 0 / 15 V; I_C = 200 A$		630		nC
$Q_{gs}$	gate source charge					nC
$Q_{gd}$	gate drain (Miller) charge					nC
$t_{d(on)}$	turn-on delay time	} Inductive switching $V_{CE} = 680 V; I_C = 200 A$ $V_{GE} = \pm 15 V; R_G = 3.9 \Omega$ (external)	$T_{VJ} = 25^\circ C$		170	ns
$t_r$	current rise time				55	ns
$t_{d(off)}$	turn-off delay time				290	ns
$t_f$	current fall time				120	ns
$E_{on}$	turn-on energy per pulse				17.1	mJ
$E_{off}$	turn-off energy per pulse				14.2	mJ
$E_{rec(off)}$	reverse recovery losses at turn-off				3.5	mJ
$t_{d(on)}$	turn-on delay time	} Inductive switching $V_{CE} = 680 V; I_C = 200 A$ $V_{GE} = \pm 15 V; R_G = 3.9 \Omega$ (external)	$T_{VJ} = 150^\circ C$		180	ns
$t_r$	current rise time				70	ns
$t_{d(off)}$	turn-off delay time				360	ns
$t_f$	current fall time				215	ns
$E_{on}$	turn-on energy per pulse				23.5	mJ
$E_{off}$	turn-off energy per pulse				20.5	mJ
$E_{rec(off)}$	reverse recovery losses at turn-off				9.2	mJ
<b>RBSOA</b>	reverse bias safe operating area	} $V_{GE} = \pm 15 V; R_G = 3.9 \Omega$ $V_{CEmax} = 1200 V$	$T_{VJ} = 150^\circ C$		400	A
$I_{CM}$						
<b>SCSOA</b>	short circuit safe operating area	} $V_{CEmax} = 1200 V$ $V_{CE} = 900 V; V_{GE} = \pm 15 V$ non-repetitive	$T_{VJ} = 150^\circ C$		10	$\mu s$
$t_{SC}$	short circuit duration				900	A
$I_{SC}$	short circuit current					
$R_{thJC}$	thermal resistance junction to case	with heatsink compound; IXYS test setup		0.24	0.16	K/W
$R_{thJH}$	thermal resistance junction to heatsink					K/W

Inverter Diode D1 - D6				Ratings		
Symbol	Definitions	Conditions	min.	typ.	max.	Unit
$V_{RRM}$	max. repetitive reverse voltage	$I_R = 500 \mu A$ , see $V_{CES}$	$T_{VJ} = 25^\circ C$	1200		1200 V
$I_{F25}$	forward current		$T_C = 25^\circ C$			189 A
$I_{F80}$			$T_C = 80^\circ C$			136 A
$I_{F100}$			$T_C = 100^\circ C$			114 A
$V_F$	forward voltage on die level	$I_F = 150 A$	$T_{VJ} = 25^\circ C$ $T_{VJ} = 150^\circ C$		1.7 1.65	2.0 1.95 V
$I_R$	reverse current * not applicable, see $I_{ces}$ at IGBT	$V_R = V_{RRM}$	$T_{VJ} = 25^\circ C$ $T_{VJ} = 150^\circ C$		*	* mA mA
$Q_{RM}$	reverse recovery charge	$V_{CE} = 600 V$ ; $I_C = 150 A$ $V_{GE} = \pm 15 V$ ; $R_G = 3.9 \Omega$ (external)	$T_{VJ} = 25^\circ C$		11.4	$\mu C$
$I_{RM}$	max. reverse recovery current				150	A
$t_{rr}$	reverse recovery time				230	ns
$E_{rec}$	reverse recovery energy				3.5	mJ
$Q_{RM}$	reverse recovery charge	$V_{CE} = 600 V$ ; $I_C = 150 A$ $V_{GE} = \pm 15 V$ ; $R_G = 3.9 \Omega$ (external)	$T_{VJ} = 150^\circ C$		25.3	$\mu C$
$I_{RM}$	max. reverse recovery current				170	A
$t_{rr}$	reverse recovery time				420	ns
$E_{rec}$	reverse recovery energy				9.2	mJ
$R_{thJC}$	thermal resistance junction to case	with heatsink compound; IXYS test setup			0.38	K/W
$R_{thJH}$	thermal resistance junction to heatsink			0.48	K/W	

Shunt Resistor				Ratings		
Symbol	Definitions	Conditions	min.	typ.	max.	Unit
$R_{SHUNT}$	resistance tolerance		$T_C = 25^\circ C$		0.5	m $\Omega$
$R_{thSH}$	thermal resistance shunt to heatsink	with heatsink compound; IXYS test setup *			10	K/W

\* Note: Continuous shunt temperature should not exceed 170°C

Temperature Sensor NTC						
Symbol	Definitions	Conditions	min.	typ.	max.	Unit
$R_{25}$	resistance	$T_{VJ} = 25^\circ C$	4.75	5.0	5.25	k $\Omega$
$B_{25/50}$	temperature coefficient			3375		K

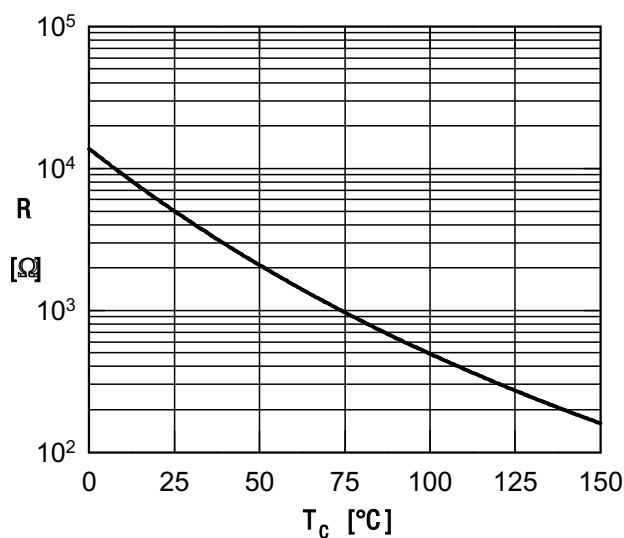

Typ. NTC resistance vs. temperature

Package E3-Pack				Ratings		
Symbol	Definitions	Conditions	min.	typ.	max.	Unit
$I_{RMS}$	RMS current	per terminal			30	A
$T_{stg}$	storage temperature		-40		125	°C
$T_{op}$	operation temperature		-40		150	°C
$T_{VJ}$	virtual junction temperature		-40		175	°C
<b>Weight</b>					320	g
$M_D$	mounting torque		3		6	Nm
$d_{Spp}$	creepage distance on surface	terminal to terminal	6			mm
$d_{Spb}$		terminal to backside	12			mm
$d_{App}$	striking distance through air	terminal to terminal	6			mm
$d_{Apb}$		terminal to backside	12			mm
$V_{ISOL}$	isolation voltage	t = 1 second t = 1 minute	4300 3600			V V
$R_{pin-chip}$	resistance pin to chip	$V = V_{CEsat} + 2 \cdot R \cdot I_C$ resp. $V = V_F + 2 \cdot R \cdot I_F$				mΩ
$C_P$	coupling capacity per switch	between shorted pins of switch and back side metallization				pF

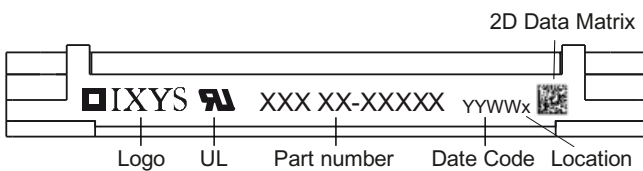

### Part number

- M = Module
- I = IGBT
- X = XPT IGBT
- G = Gen 2 / std
- 240 = Current Rating [A]
- W = 6-pack
- 1200 = Reverse Voltage [V]
- PZT = PressFit Pin + Shunt 0.5mΩ, Thermistor
- EH = E3-Pack

Ordering	Part Name	Marking on Product	Delivering Mode	Base Qty	Ordering Code
Standard	MIXG240W1200PZTEH	MIXG240W1200PZTEH	Blister	24	522740
with Phase Change Material	MIXG240W1200PZTEH -PC	MIXG240W1200PZTEH	Blister	24	522733

Similar Part	Package	Voltage class
MIXG240W1200TEH	E3- Pack	1200
MIXG240W1200PTEH	E3- Pack, press fit pin	1200

Option: phase change material; please contact IXYS sales office for availability

### Equivalent Circuits for Simulation \*on die level

$V_{0\ max}$	threshold voltage	$T_{VJ} = 125^\circ\text{C}$	IGBT	Inverter Diode	V
$R_{0\ max}$	slope resistance *				mΩ
$V_{0\ max}$	threshold voltage	$T_{VJ} = 175^\circ\text{C}$	1.2	1.2	V
$R_{0\ max}$	slope resistance *		5.8	4.7	mΩ

Outlines E3-Pack

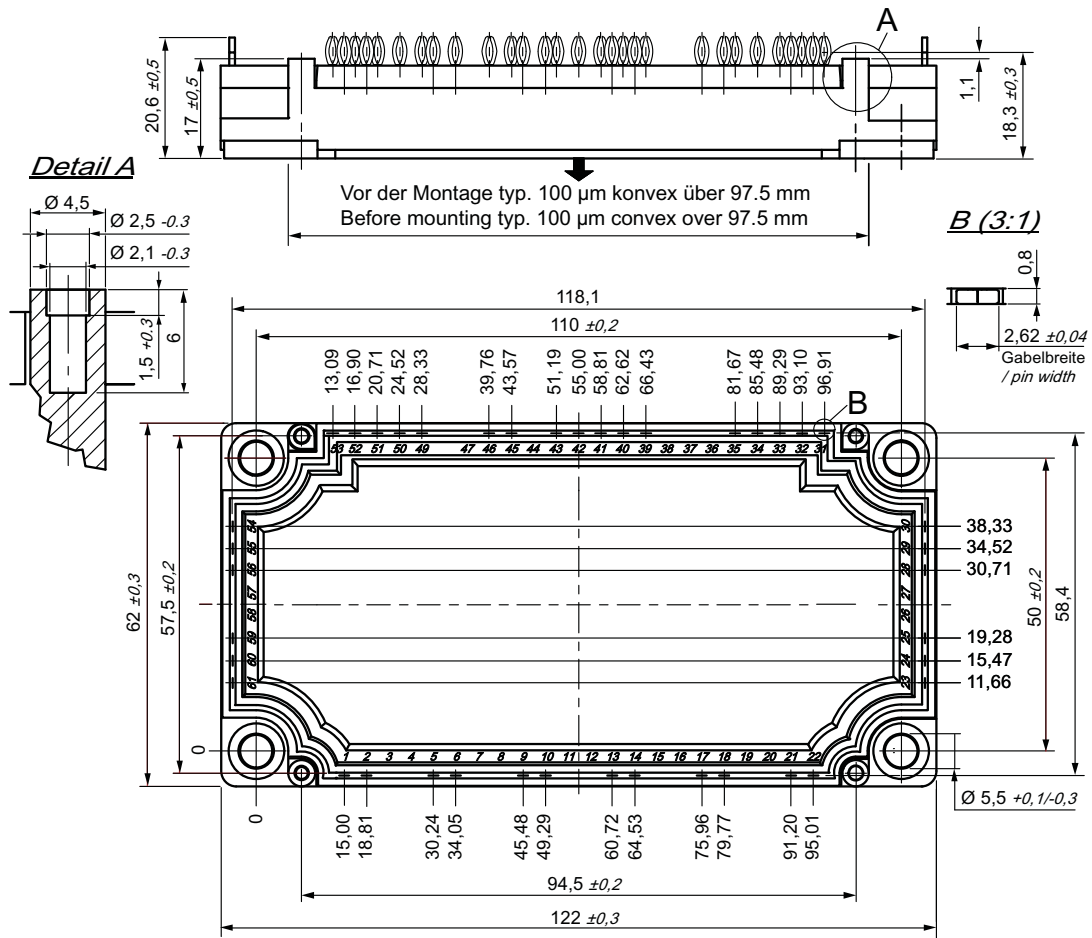

**Bemerkung / Note:**

- Nichttolerierete Maße nach / Measure without tolerances according DIN ISO 2768-T1-m
- PCB-Lochmuster / PCB hole pattern: **see pin position**
- Toleranz Pin-Position und PCB-Lochmuster / Tolerance of pin position and PCB hole pattern:  $\oplus 0.1$
- Bohrlochdurchmesser / Diameter of drill: **Ø 2.35 mm**
- Endlochdurchmesser / Diameter of plated holes: **Ø 2.14 - 2.29 mm** (Cu thickness in via typ. 50 µm)
- Beschichtung / Plating: **chem. Sn max. 15 µm**
- Einpresskraft / Insert Force: per terminal with a typ. insert speed of 7 mm/s: **typ. 90 N**
- Weitere Angaben / Further information: [www.ixys.com](http://www.ixys.com) **Application note IXAN0077**
- Montageanleitung / Mounting instruction: [www.ixys.com](http://www.ixys.com) **Application note IXAN0024**

**Detail A:** PCB-Montage / Mounting on PCB

- Empfohlene, selbstschneidende Schraube / Recommended, self-tapping screw: **EJOT PT®** (Größe / size: **K25**)
- Max. Schraubenlänge / Max. screw length: **PCB-Dicke / thickness + 6 mm** (max. Lochtiefe / hole depth)
- Empfohlenes Drehmoment / Recommended mounting torque: **1.5 Nm**

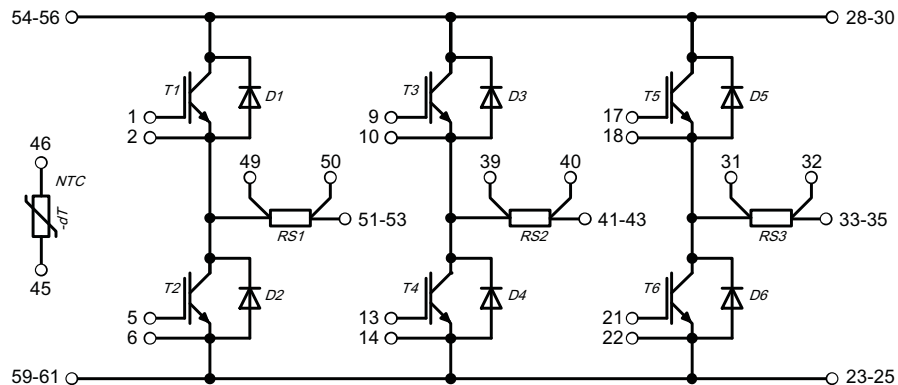

IGBT T1 - T6

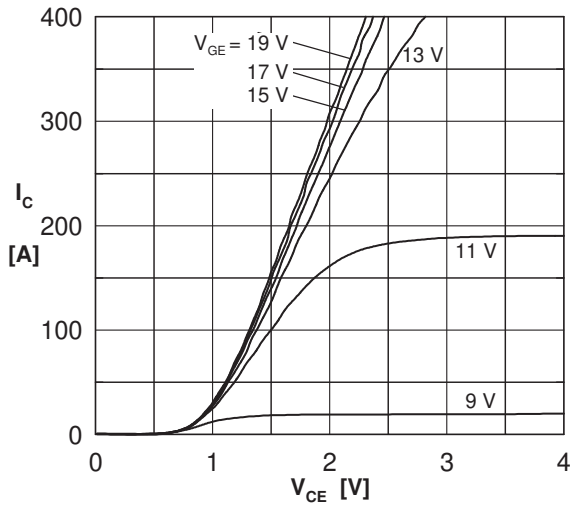

Fig. 1 Typ. output characteristics ( $T_{VJ} = 25^{\circ}\text{C}$ )

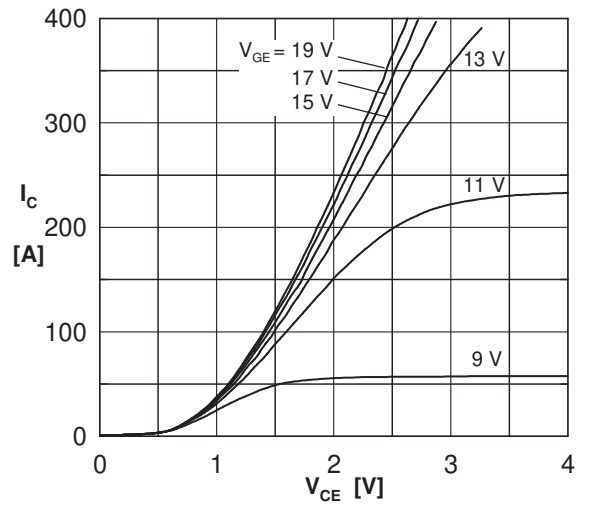

Fig. 2 Typ. output characteristics ( $T_{VJ} = 150^{\circ}\text{C}$ )

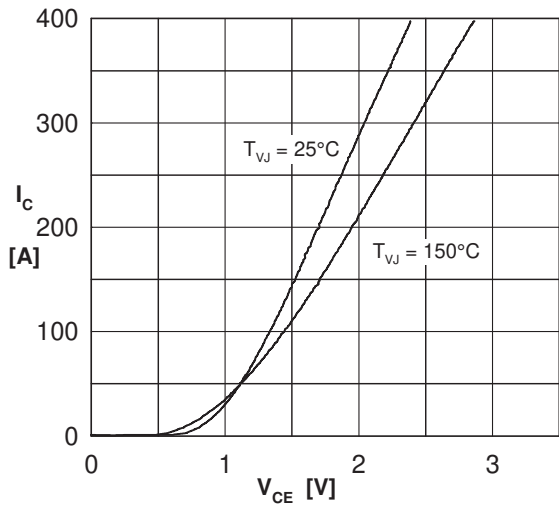

Fig. 3 Typ. output characteristics ( $V_{GE} = 15\text{V}$ )

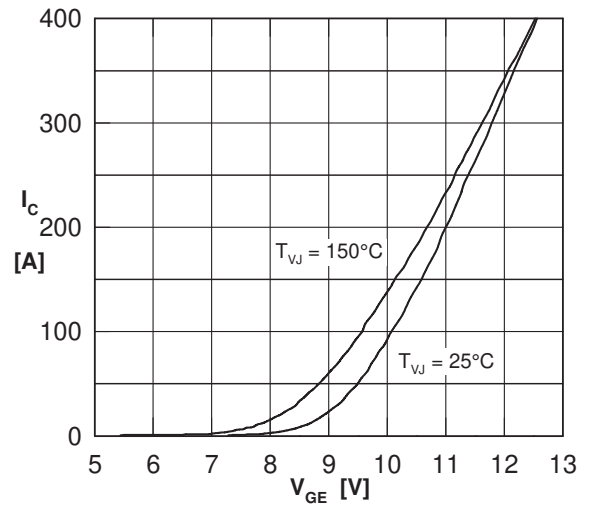

Fig. 4 Typ. transfer characteristics ( $V_{CE} = 20\text{V}$ )

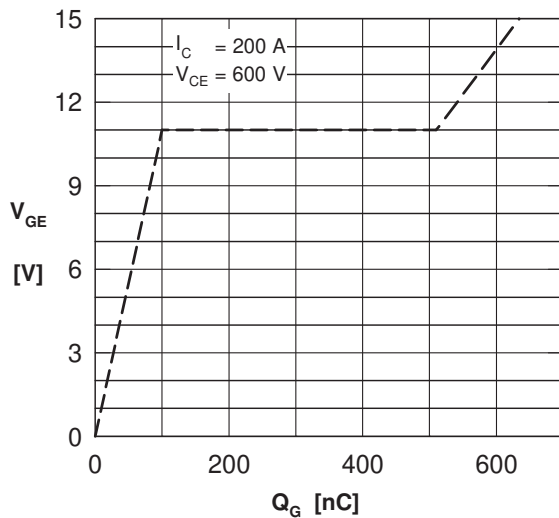

Fig. 5 Typ. turn-on gate charge 0/15V

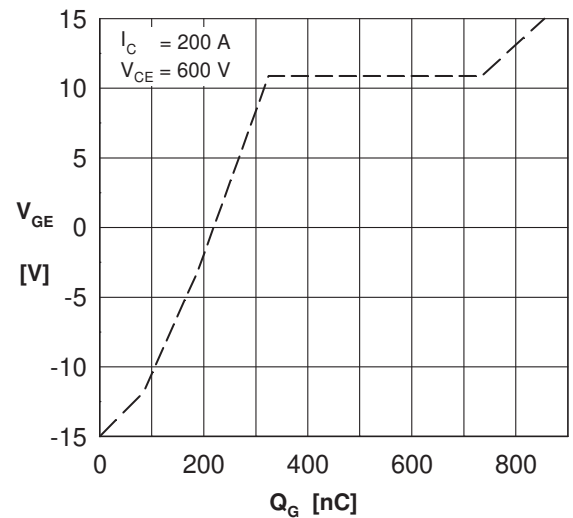

Fig. 6 Typ. turn-on gate charge -15/+15V

IGBT T1 - T6

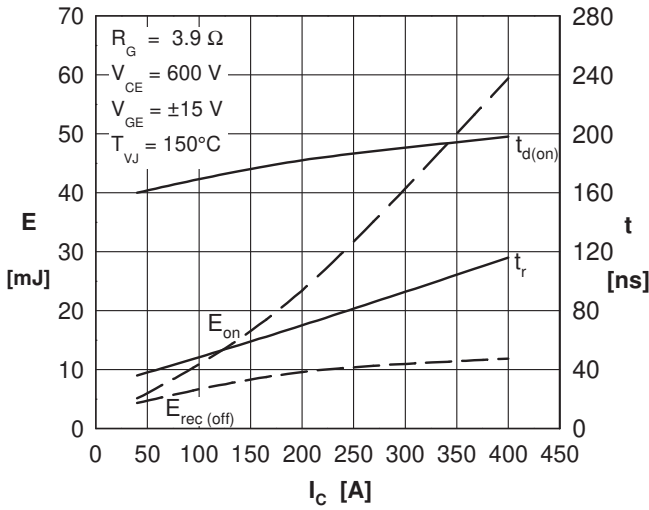

Fig. 7 Typ. switching energy versus collector current (turn on)

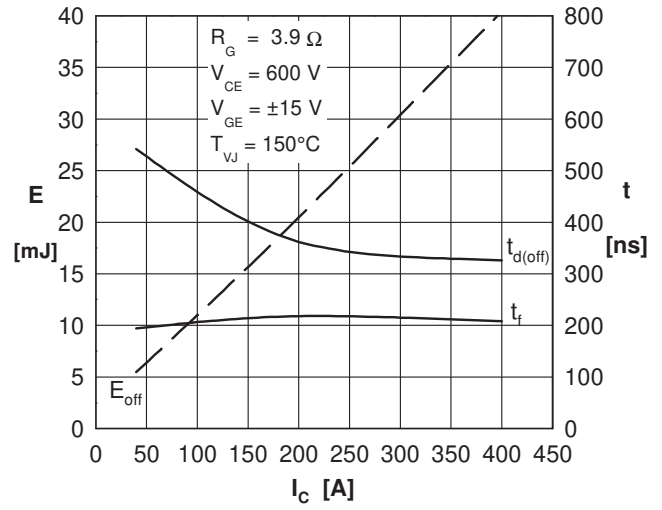

Fig. 8 Typ. switching energy versus collector current (turn off)

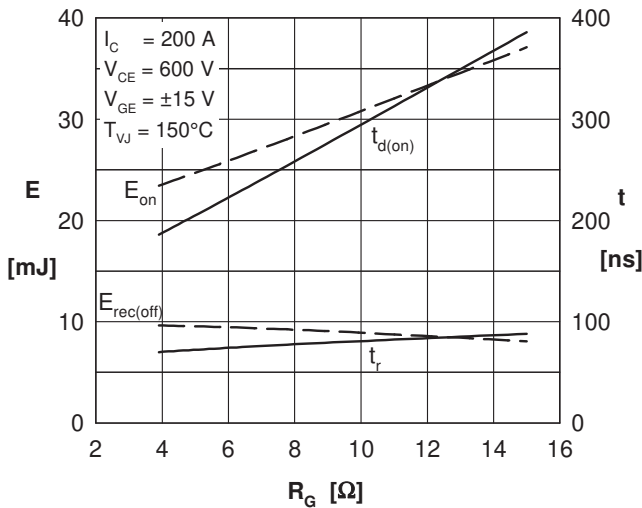

Fig. 9 Typ. switching energy versus gate resistor (turn on)

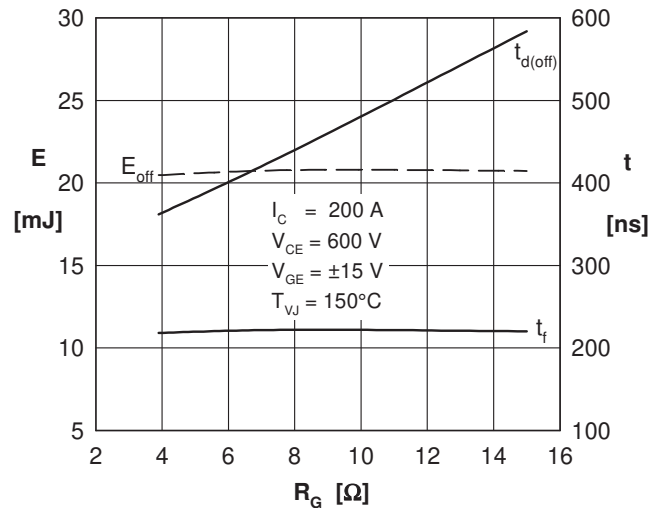

Fig. 10 Typ. switching energy versus gate resistor (turn off)

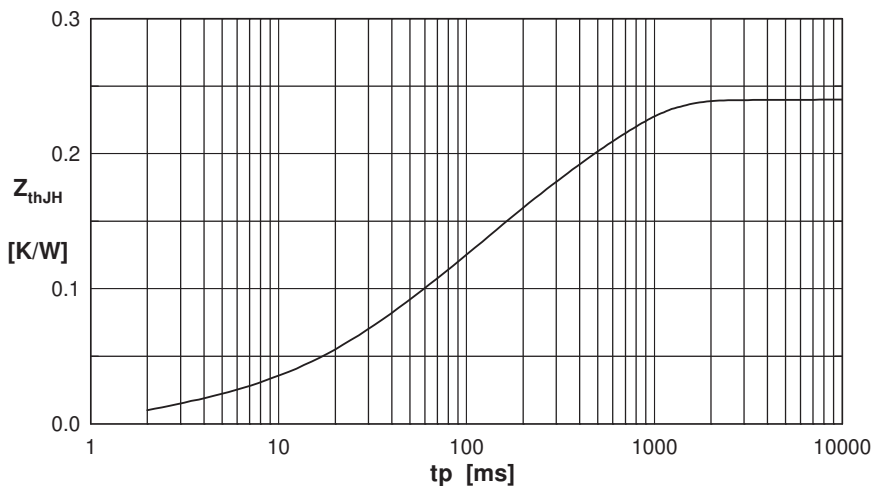
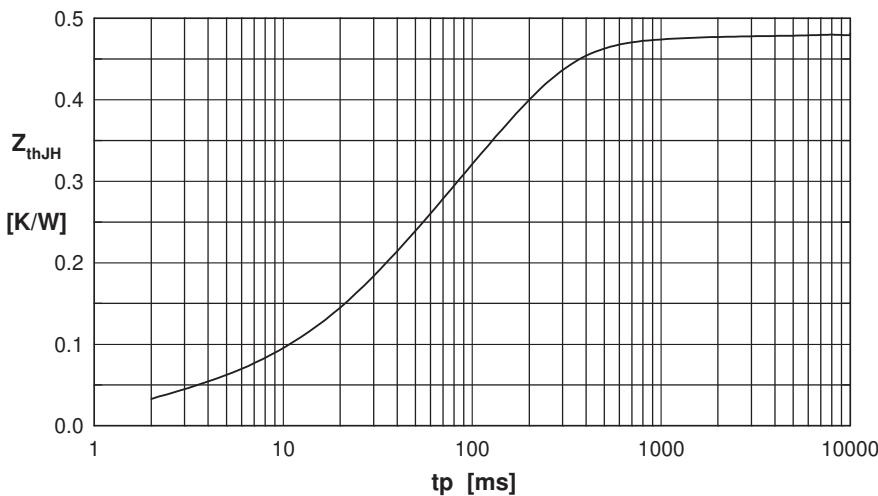
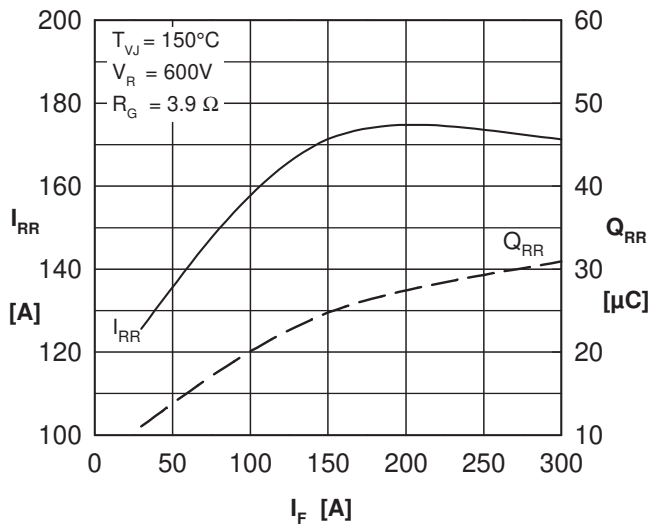
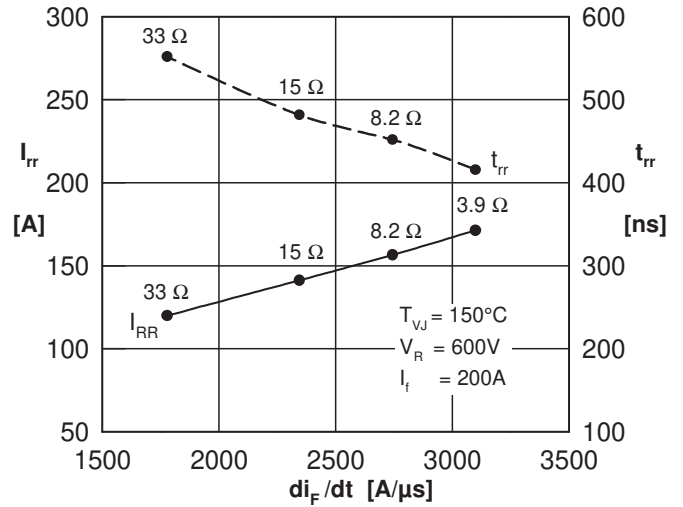
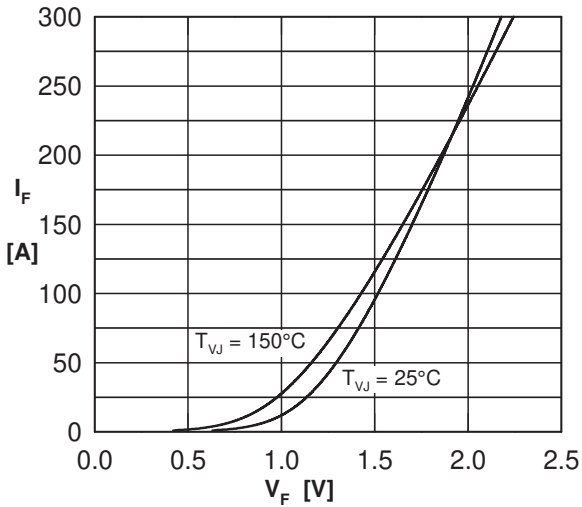

Fig. 11 IGBT: typ. transient thermal impedance to heat sink

DIODE D1 - D6







Компания «ЭлектроПласт» предлагает заключение долгосрочных отношений при поставках импортных электронных компонентов на взаимовыгодных условиях!

Наши преимущества:

- Оперативные поставки широкого спектра электронных компонентов отечественного и импортного производства напрямую от производителей и с крупнейших мировых складов;
- Поставка более 17-ти миллионов наименований электронных компонентов;
- Поставка сложных, дефицитных, либо снятых с производства позиций;
- Оперативные сроки поставки под заказ (от 5 рабочих дней);
- Экспресс доставка в любую точку России;
- Техническая поддержка проекта, помощь в подборе аналогов, поставка прототипов;
- Система менеджмента качества сертифицирована по Международному стандарту ISO 9001;
- Лицензия ФСБ на осуществление работ с использованием сведений, составляющих государственную тайну;
- Поставка специализированных компонентов (Xilinx, Altera, Analog Devices, Intersil, Interpoint, Microsemi, Aeroflex, Peregrine, Syfer, Eurofarad, Texas Instrument, Miteq, Cobham, E2V, MA-COM, Hittite, Mini-Circuits, General Dynamics и др.);

Помимо этого, одним из направлений компании «ЭлектроПласт» является направление «Источники питания». Мы предлагаем Вам помощь Конструкторского отдела:

- Подбор оптимального решения, техническое обоснование при выборе компонента;
- Подбор аналогов;
- Консультации по применению компонента;
- Поставка образцов и прототипов;
- Техническая поддержка проекта;
- Защита от снятия компонента с производства.



#### Как с нами связаться

**Телефон:** 8 (812) 309 58 32 (многоканальный)

**Факс:** 8 (812) 320-02-42

**Электронная почта:** [org@eplast1.ru](mailto:org@eplast1.ru)

**Адрес:** 198099, г. Санкт-Петербург, ул. Калинина, дом 2, корпус 4, литера А.