

## EL1881

Sync Separator, Low Power

FN7018

Rev 2.00

September 15, 2011

The EL1881 video sync separator is manufactured using Elantec's high performance analog CMOS process. This device extracts sync timing information from both standard and non-standard video input. It provides composite sync, vertical sync, burst/back porch timing, and odd/even field detection. Fixed 70mV sync tip slicing provides sync edge detection when the video input level is between  $0.5V_{P-P}$  and  $-2V_{P-P}$  (sync tip amplitude 143mV to 572mV). A single external resistor sets all internal timing to adjust for various video standards. The composite sync output follows video in sync pulses and a vertical sync pulse is output on the rising edge of the first vertical serration following the vertical pre-equalizing string. For non-standard vertical inputs, a default vertical pulse is output when the vertical signal stays low for longer than the vertical sync default delay time. The odd/even output indicates field polarity detected during the vertical blanking interval. The EL1881 is plug-in compatible with the industry-standard LM1881 and can be substituted for that part in 5V applications with lower required supply current.

The EL1881 is available in the 8 Ld PDIP and SOIC packages and is specified for operation over the full  $-40^{\circ}\text{C}$  to  $+85^{\circ}\text{C}$  temperature range.

### Pinout

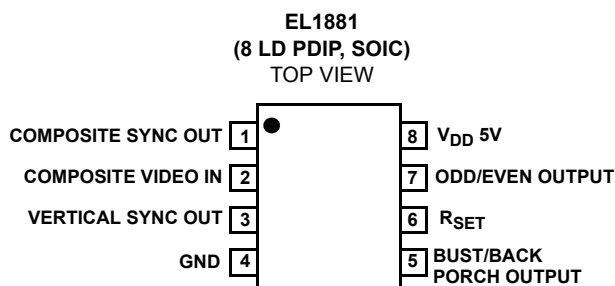

### Features

- NTSC, PAL, SECAM, non-standard video sync separation
- Fixed 70mV slicing of video input levels from  $0.5V_{P-P}$  to  $2V_{P-P}$
- Low supply current - 1.5mA typ.
- Single +5V supply
- Composite, vertical sync output
- Odd/even field output
- Burst/back porch output
- Available in 8 Ld PDIP and SOIC packages
- Pb-free available (RoHS Compliant)

### Applications

- Video amplifiers
- PCMCIA applications
- A/D drivers
- Line drivers
- Portable computers
- High-speed communications
- RGB applications
- Broadcast equipment
- Active filtering

### Demo Board

A dedicated demo board is available.

## Pin Descriptions

| PIN NUMBER | PIN NAME                  | PIN FUNCTION   |
|------------|---------------------------|--|
| 1          | Composite Sync Out        | Composite sync pulse output; sync pulses start on a falling edge and end on a rising edge                                |
| 2          | Composite Video In        | AC coupled composite video input; sync tip must be at the lowest potential (positive picture phase)                      |
| 3          | Vertical Sync Out         | Vertical sync pulse output; the falling edge of vert sync is the start of the vertical period                            |
| 4          | GND                       | Supply ground  |
| 5          | Burst/Back Porch Output   | Burst/back porch output; low during burst portion of composite video   |
| 6          | R <sub>SET</sub> (Note 1) | An external resistor to ground sets all internal timing; a 681k 1% resistor will provide correct timing for NTSC signals |
| 7          | Odd/Even Output           | Odd/even field output; high during odd fields, low during even fields; transitions occur at start of vert sync pulse     |
| 8          | VDD 5V                    | Positive supply (5V)   |

### NOTE:

1. R<sub>SET</sub> must be a 1% resistor

## Ordering Information

| PART NUMBER                   | PART MARKING | PACKAGE                          | PKG. DWG. # |
|-------------------------------|--------------|----------------------------------|-------------|
| EL1881CN                      | EL1881CN     | 8 Ld PDIP                        | E8.3        |
| EL1881CS                      | 1881CS       | 8 Ld SOIC                        | M8.15E      |
| EL1881CS-T7 (Note 2)          | 1881CS       | 8 Ld SOIC (Tape & Reel)          | M8.15E      |
| EL1881CSZ (Notes 3, 4)        | 1881CSZ      | 8 Ld SOIC (Pb-free)              | M8.15E      |
| EL1881CSZ-T7 (Notes 2, 3, 4)  | 1881CSZ      | 8 Ld SOIC (Pb-free, Tape & Reel) | M8.15E      |
| EL1881CSZ-T13 (Notes 2, 3, 4) | 1881CSZ      | 8 Ld SOIC (Pb-free, Tape & Reel) | M8.15E      |

### NOTES:

2. Please refer to TB347 for details on reel specifications.
3. These Intersil Pb-free plastic packaged products employ special Pb-free material sets, molding compounds/die attach materials, and 100% matte tin plate plus anneal (e3 termination finish, which is RoHS compliant and compatible with both SnPb and Pb-free soldering operations). Intersil Pb-free products are MSL classified at Pb-free peak reflow temperatures that meet or exceed the Pb-free requirements of IPC/JEDEC J STD-020.
4. For Moisture Sensitivity Level (MSL), please see device information page for [EL1881](#). For more information on MSL, please see Technical Brief [TB363](#).

**Absolute Maximum Ratings** ( $T_A = +25^\circ\text{C}$ )

|                     |                          |
|---------------------|--------------------------|
| $V_{CC}$ Supply     | .7V                      |
| Storage Temperature | -65°C to +150°C          |
| Pin Voltages        | -0.5V to $V_{CC} + 0.5V$ |

**Thermal Information**

|                                      |                      |
|--------------------------------------|----------------------|
| Thermal Resistance (Typical, Note 5) | $\theta_{JA}$ (°C/W) |
| 8 Lead PDIP                          | 85                   |
| 8 Lead SOIC                          | 95 to 120            |
| Operating Ambient Temperature Range  | -40°C to +85°C       |
| Operating Junction Temperature       | 150°C                |
| Power Dissipation                    | 400mW                |

**CAUTION:** Do not operate at or near the maximum ratings listed for extended periods of time. Exposure to such conditions may adversely impact product reliability and result in failures not covered by warranty.

**NOTE:**

5.  $\theta_{JA}$  is measured with the component mounted on a high effective thermal conductivity test board in free air. See Tech Brief [TB379](#) for details.

**IMPORTANT NOTE:** All parameters having Min/Max specifications are guaranteed. Typical values are for information purposes only. Unless otherwise noted, all tests are at the specified temperature and are pulsed tests, therefore:  $T_J = T_C = T_A$

**DC Electrical Specifications**  $V_{DD} = 5V$ ,  $T_A = +25^\circ\text{C}$ ,  $R_{SET} = 681k\Omega$ , unless otherwise specified.

| PARAMETER                       | DESCRIPTION                         | MIN  | TYP  | MAX  | UNIT          |
|---------------------------------|-------------------------------------|------|------|------|---------------|
| $I_{DD}$ , Quiescent            | $V_{DD} = 5V$                       | 0.75 | 1.5  | 3    | mA            |
| Clamp Voltage                   | Pin 2, $I_{LOAD} = -100\mu\text{A}$ | 1.35 | 1.5  | 1.65 | V             |
| Clamp Discharge Current         | Pin 2 = 2V                          | 6    | 12   | 16   | $\mu\text{A}$ |
| Clamp Charge Current            | Pin 2 = 1V                          | -1.3 | -1   | 0.7  | mA            |
| $R_{SET}$ Pin Reference Voltage | Pin 6                               | 1.1  | 1.22 | 1.35 | V             |
| $V_{OL}$ Output Low Voltage     | $I_{OL} = 1.6\text{mA}$             |      | 0.24 | 0.5  | V             |
| $V_{OH}$ Output High Voltage    | $I_{OH} = -40\mu\text{A}$           | 4    | 4.8  |      | V             |
|                                 | $I_{OH} = -1.6\text{mA}$            | 3    | 4.6  |      | V             |

**Dynamic Specifications**

| PARAMETER                              | DESCRIPTION                                      | MIN | TYP | MAX | UNIT          |
|--|--|-----|-----|-----|---------------|
| Comp Sync Prop Delay, $t_{CS}$         | See Figure 20                                    | 20  | 35  | 75  | ns            |
| Vertical Sync Width, $t_{VS}$          | Normal or Default Trigger, 50% to 50%            | 190 | 230 | 300 | $\mu\text{s}$ |
| Vertical Sync Default Delay, $t_{VSD}$ | See Figure 21                                    | 35  | 62  | 85  | $\mu\text{s}$ |
| Burst/Back Porch Delay, $t_{BD}$       | See Figure 20                                    | 120 | 200 | 300 | ns            |
| Burst/Back Porch Width, $t_B$          | See Figure 20                                    | 2.5 | 3.5 | 4.5 | $\mu\text{s}$ |
| Input Dynamic Range                    | Video Input Amplitude to Maintain 50% Slice Spec | 0.5 |     | 2   | $V_{P-P}$     |
| Slice Level                            | $V_{SLICE}/V_{CLAMP}$                            | 55  | 70  | 85  | mV            |

## Typical Performance Curves

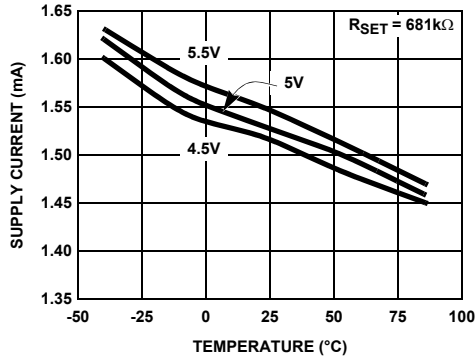

FIGURE 1. SUPPLY CURRENT vs TEMPERATURE

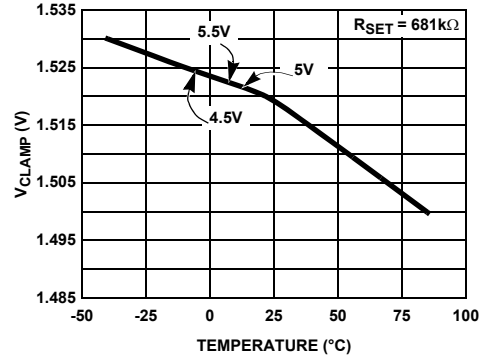

FIGURE 2.  $V_{CLAMP}$  VOLTAGE vs TEMPERATURE

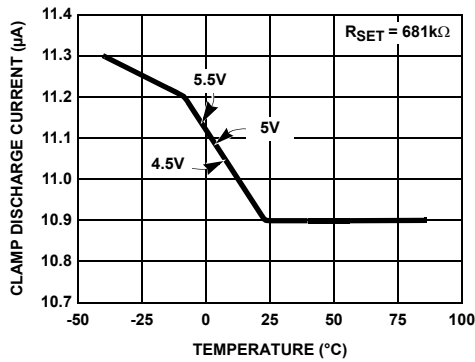

FIGURE 3. CLAMP DISCHARGE CURRENT vs TEMPERATURE

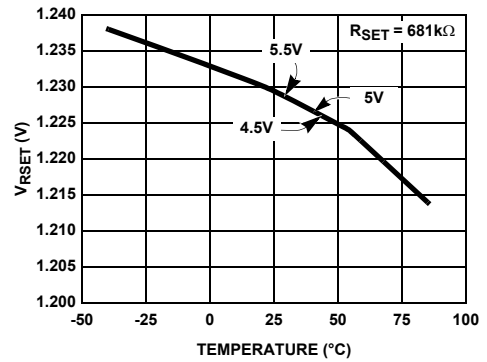

FIGURE 4.  $V_{RSET}$  vs TEMPERATURE

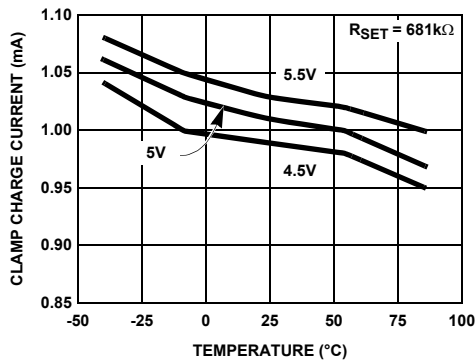

FIGURE 5. CLAMP CHARGE CURRENT vs TEMPERATURE

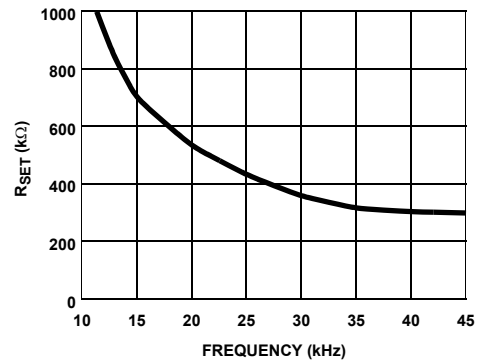

FIGURE 6.  $R_{SET}$  vs HORIZONTAL FREQUENCY

**Typical Performance Curves** (Continued)

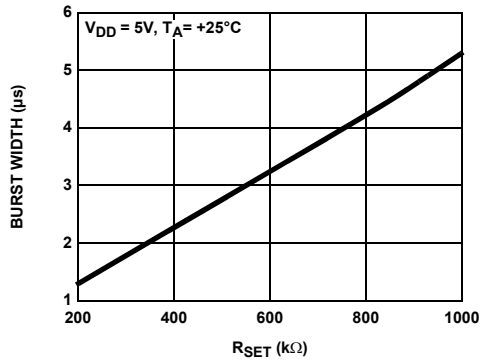

FIGURE 7. BURST/BACK PORCH WIDTH vs RSET

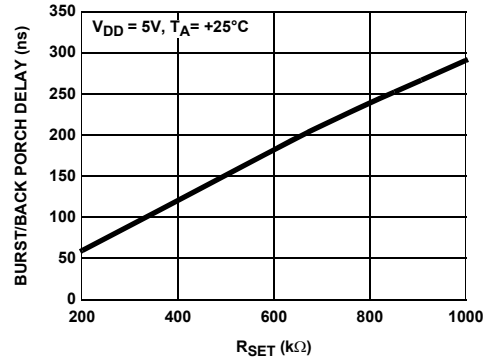

FIGURE 8. BURST/BACK PORCH DELAY vs RSET

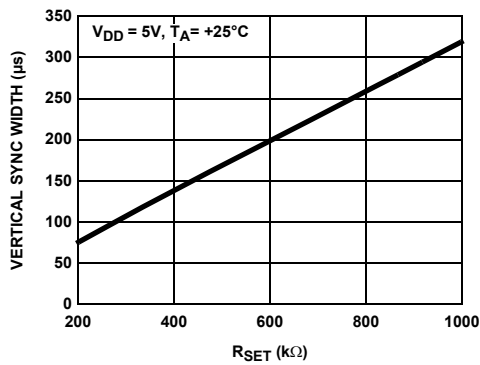

FIGURE 9. VERTICAL SYNC WIDTH vs RSET

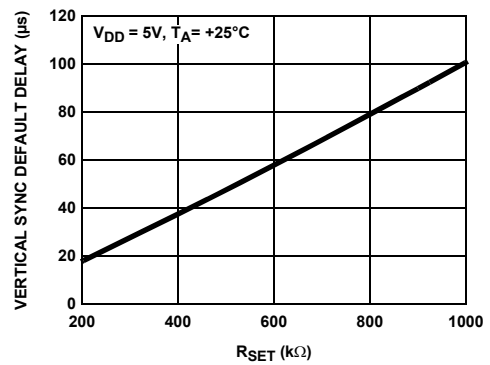

FIGURE 10. VERTICAL DEFAULT DELAY vs RSET

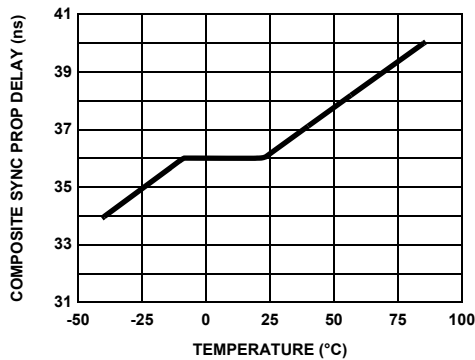

FIGURE 11. COMPOSITE SYNC PROP DELAY vs TEMPERATURE

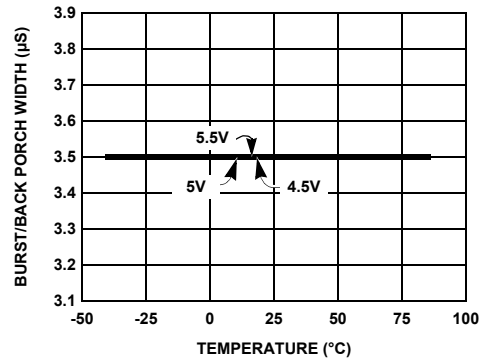

FIGURE 12. BURST/BACK PORCH WIDTH vs TEMPERATURE

**Typical Performance Curves** (Continued)

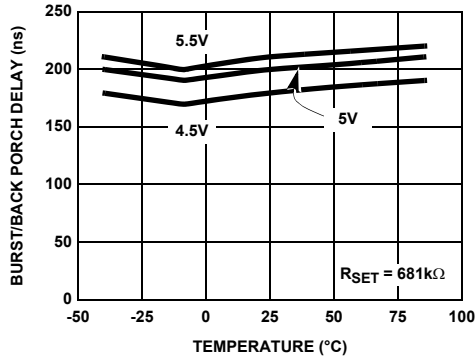

FIGURE 13. BURST/BACK PORCH DELAY vs TEMPERATURE

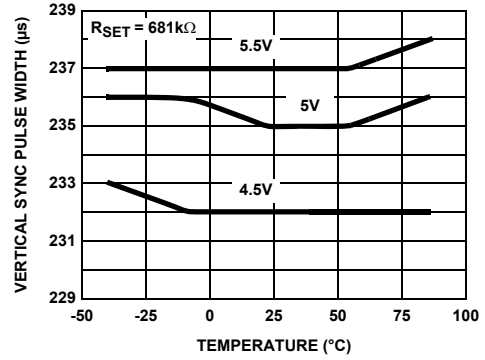

FIGURE 14. VERTICAL SYNC PULSE WIDTH vs TEMPERATURE

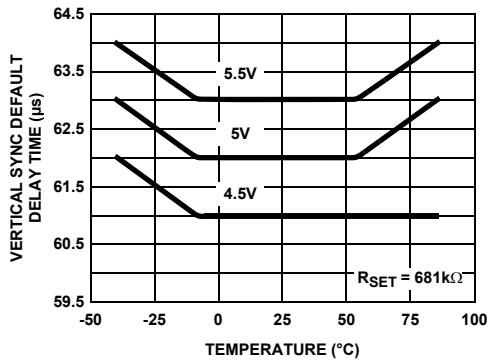

FIGURE 15. VERTICAL SYNC DEFAULT DELAY TIME vs TEMPERATURE

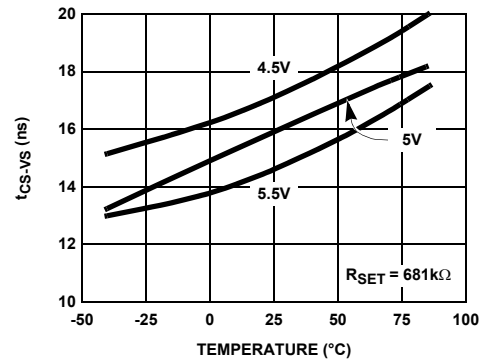

FIGURE 16. COMPOSITE SYNC TO VERTICAL SYNC DELAY TIME

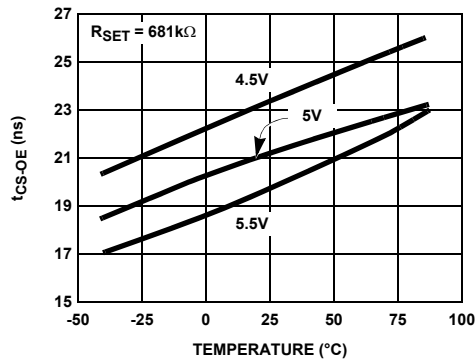

FIGURE 17. COMPOSITE SYNC TO ODD/EVEN DELAY TIME

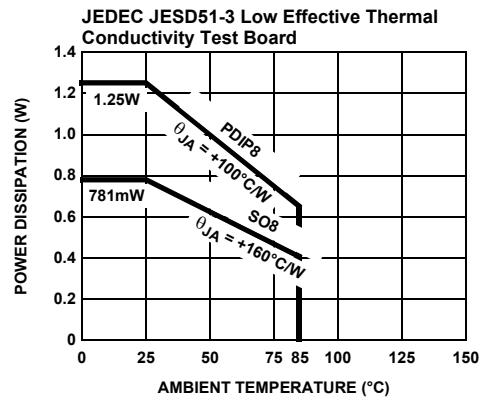
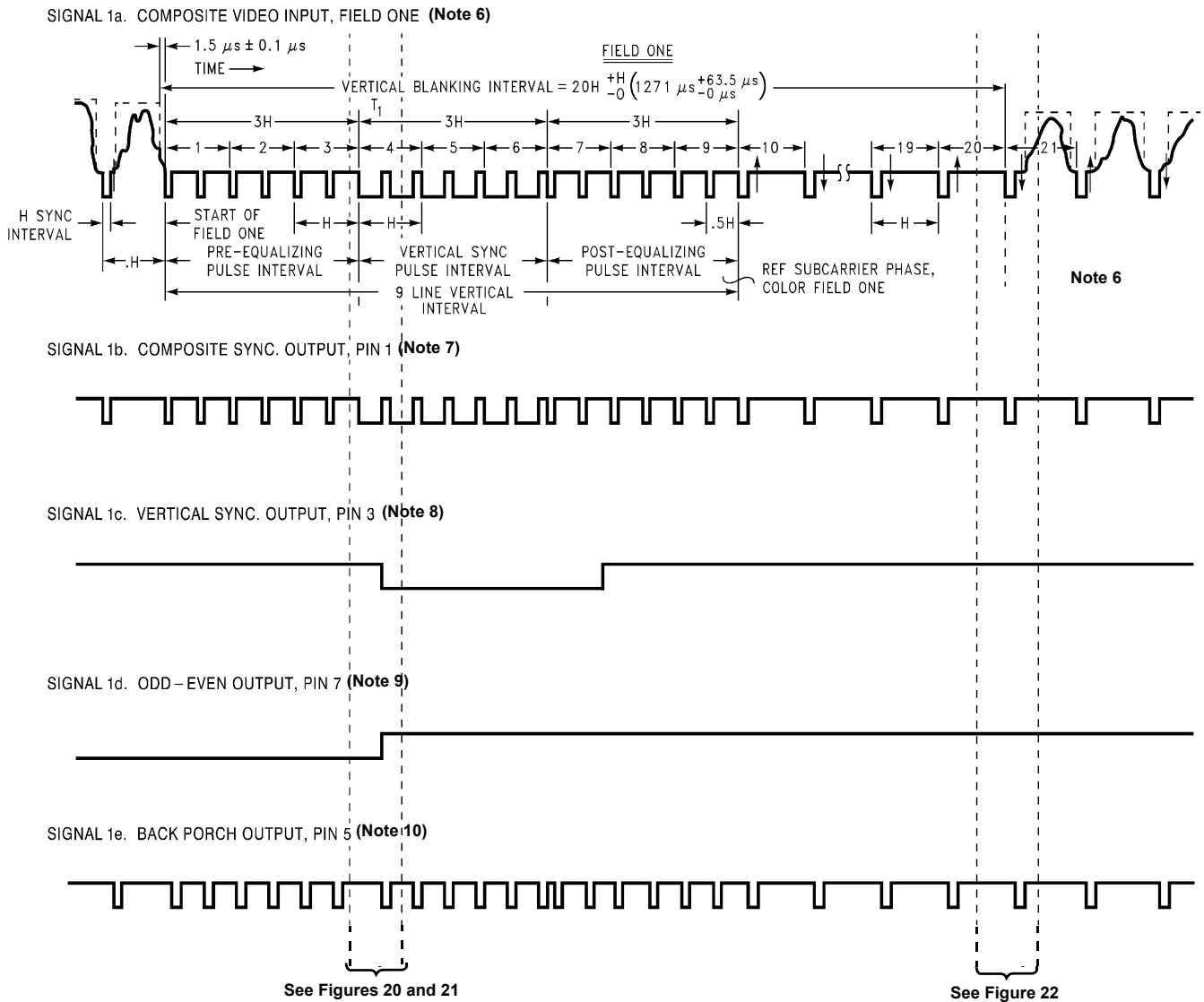

FIGURE 18. PACKAGE POWER DISSIPATION vs AMBIENT TEMPERATURE

## Timing Diagrams



**NOTES:**

6. Signal 1a drawing reproduced with permission from EIA.
7. The composite sync output reproduces all the video input sync pulses, with a propagation delay.
8. Vertical sync leading edge is coincident with the first vertical serration pulse leading edge, with a propagation delay.
9. Odd-even output is low for even field, and high for odd field.
10. Back porch goes low for a fixed pulse width on the trailing edge of video input sync pulses. Note that for serration pulses during vertical, the back porch starts on the rising edge of the serration pulse (with propagation delay).

**FIGURE 19. STANDARD (NTSC INPUT) TIMING**

**Expanded Timing Diagrams**

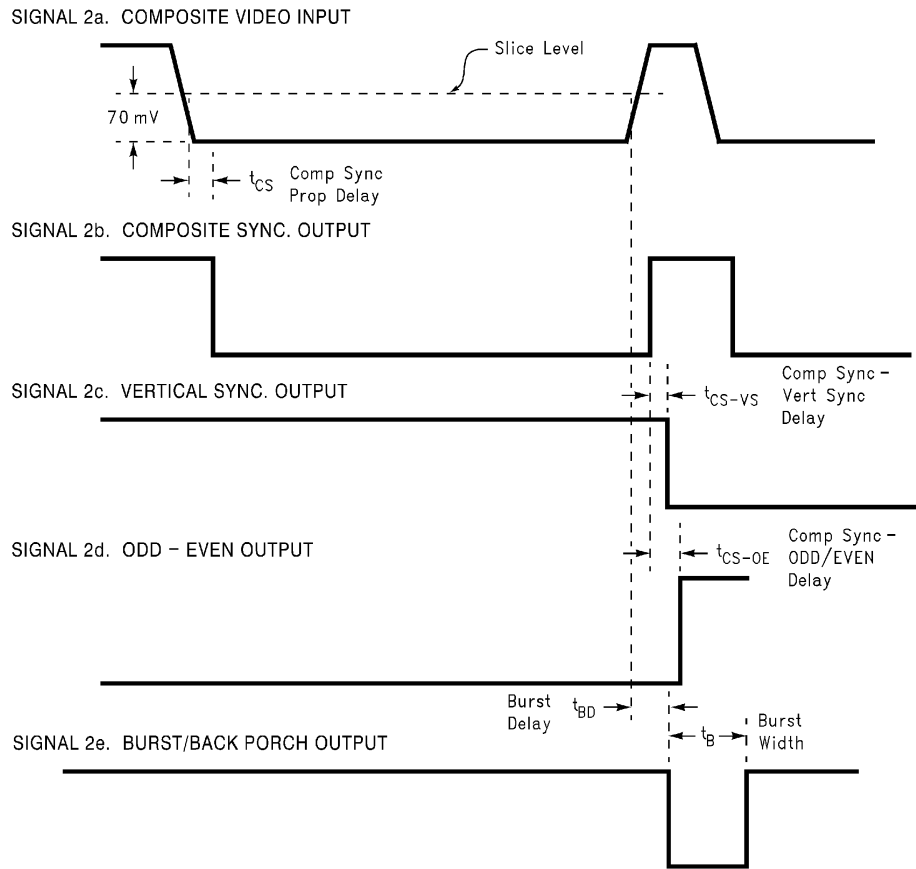

**FIGURE 20. STANDARD VERTICAL TIMING**

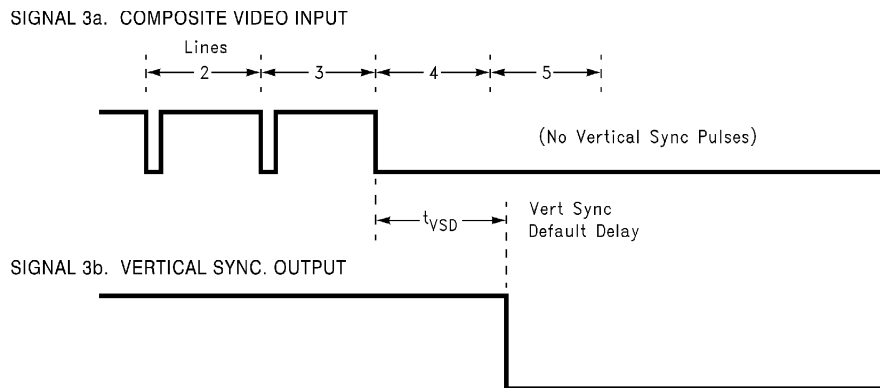

**FIGURE 21. NON-STANDARD VERTICAL TIMING**



**Expanded Timing Diagrams (Continued)**

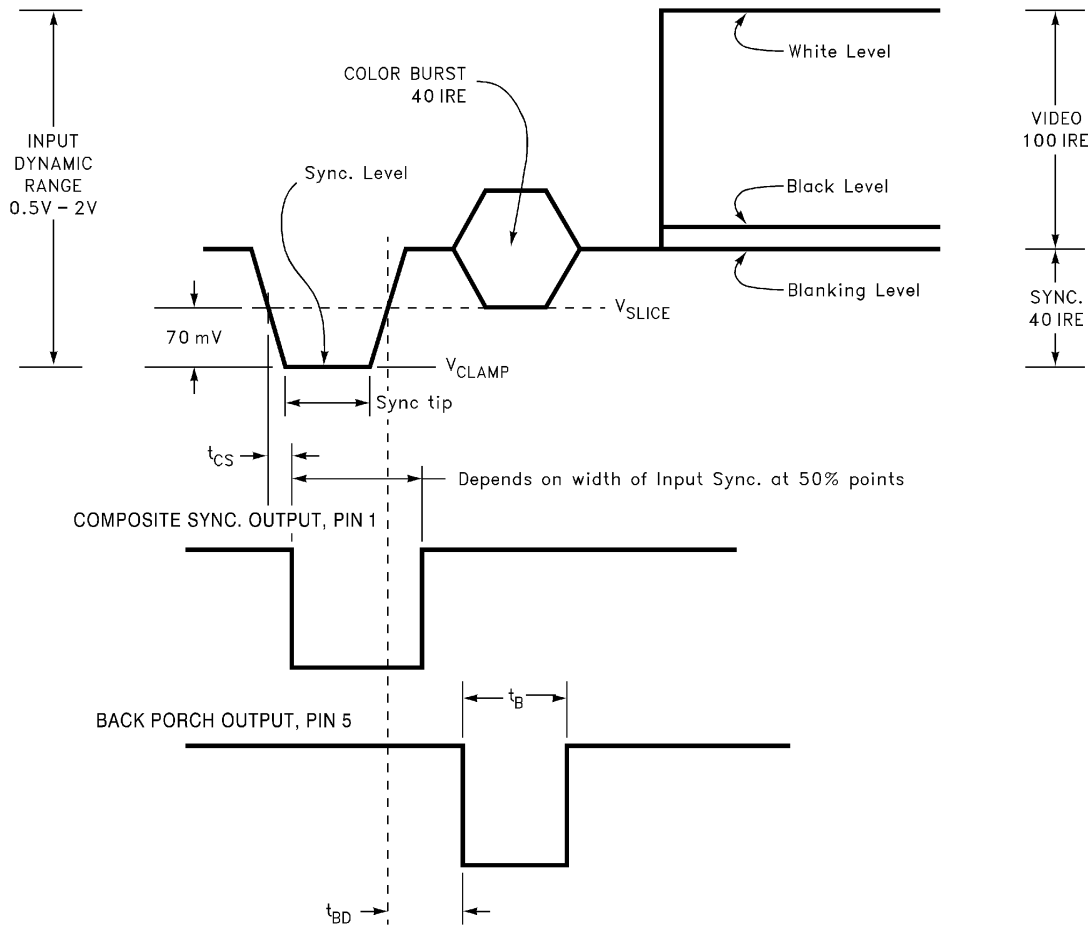

**FIGURE 22. STANDARD VERTICAL TIMING**

**Applications Information**

**Video In**

Figure 24 shows a “Simplified Block Diagram” on page 11.

An AC-coupled video signal is input to Video In pin 2 via,  $C_1$  nominally 0.1 $\mu$ F. Clamp charge current will prevent the signal on pin 2 from going any more negative than Sync Tip Ref, about 1.5V. This charge current is nominally about 1mA. A clamp discharge current of about 10 $\mu$ A is always attempting to discharge  $C_1$  to Sync Tip Ref, thus charge is lost between sync pulses that must be replaced during sync pulses. The droop voltage that will occur can be calculated from  $I t = CV$ , where V is the droop voltage, I is the discharge current, t is the time between sync pulses (sync period - sync tip width), and C is  $C_1$ .

An NTSC video signal has a horizontal frequency of 15.73kHz, and a sync tip width of 4.7 $\mu$ s. This gives a period of 63.6 $\mu$ s and a time  $t = 58.9\mu$ s. The droop voltage will then be  $V = 5.9$ mV. This is < 2% of a nominal sync tip amplitude of 286mV. The charge represented by this droop is replaced in a time given by  $t = CV/I$ , where I = clamp charge current =

1mA. Here  $t = 590$ ns, about 12% of the sync pulse width of 4.7 $\mu$ s. It is important to choose  $C_1$  large enough so that the droop voltage does not approach the switching threshold of the internal comparator.

**Fixed Gain Buffer**

The clamped video signal then passes to the fixed gain buffer which places the sync slice level at the equivalent level of 70mV above sync tip. The output of this buffer is presented to the comparator, along with the slice reference. The comparator output is level shifted and buffered to TTL levels, and sent out as Composite Sync to pin 1.

**Burst**

A low-going Burst pulse follows each rising edge of sync, and lasts approximately 3.5 $\mu$ s for an  $R_{SET}$  of 681k $\Omega$ .

**Vertical Sync**

A low-going Vertical Sync pulse is output during the start of the vertical cycle of the incoming video signal. The vertical cycle starts with a pre-equalizing phase of pulses with a duty cycle of about 93%, followed by a vertical serration phase

that has a duty cycle of about 15%. Vertical Sync is clocked out of the EL1881 on the first rising edge during the vertical serration phase. In the absence of vertical serration pulses, a vertical sync pulse will be forced out after the vertical sync default delay time, approximately  $60\mu\text{s}$  after the last falling edge of the vertical equalizing phase for  $R_{\text{SET}} = 681\text{k}\Omega$ .

### Odd/Even

Because a typical television picture is composed of two interlaced fields, there is an odd field that includes all the odd lines, and an even field that consists of the even lines. This odd/even field information is decoded by the EL1881 during the end of picture information and the beginning of vertical information. The odd/even circuit includes a T-flip-flop that is reset during full horizontal lines, but not during half lines or vertical equalization pulses. The T-flip-flop is clocked during each falling edge of these half-period pulses. Even fields will toggle until a low state is clocked to the odd/even pin 7 at the beginning of vertical sync, and odd fields will cause a high state to be clocked to the odd/even pin at the start of the next vertical sync pulse. Odd/even can be ignored if using non-interlaced video, as there is no change in timing from one field to the next.

### $R_{\text{SET}}$

An external  $R_{\text{SET}}$  resistor, connected from  $R_{\text{SET}}$  pin 6 to ground, produces a reference current that is used internally as the timing reference for vertical sync width, vertical sync default delay, burst gate delay and burst width. Decreasing the value of  $R_{\text{SET}}$  increases the reference current, which in turn decreases reference times and pulse widths. A higher frequency video input necessitates a lower  $R_{\text{SET}}$  value.

### Chroma Filter

A chroma filter is suggested to increase the S/N ratio of the incoming video signal. Use of the optional chroma filter is shown in Figure 23. It can be implemented very simply and inexpensively with a series resistor of  $620\Omega$  and a parallel capacitor of  $510\text{pF}$ , which gives a single pole roll-off frequency of about  $500\text{kHz}$ . This sufficiently attenuates the  $3.58\text{MHz}$  (NTSC) or  $4.43\text{MHz}$  (PAL) color burst signal, yet passes the approximately  $15\text{kHz}$  sync signals without appreciable attenuation. A chroma filter will increase the propagation delay from the composite input to the outputs.

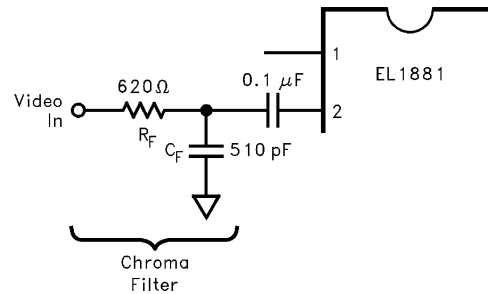
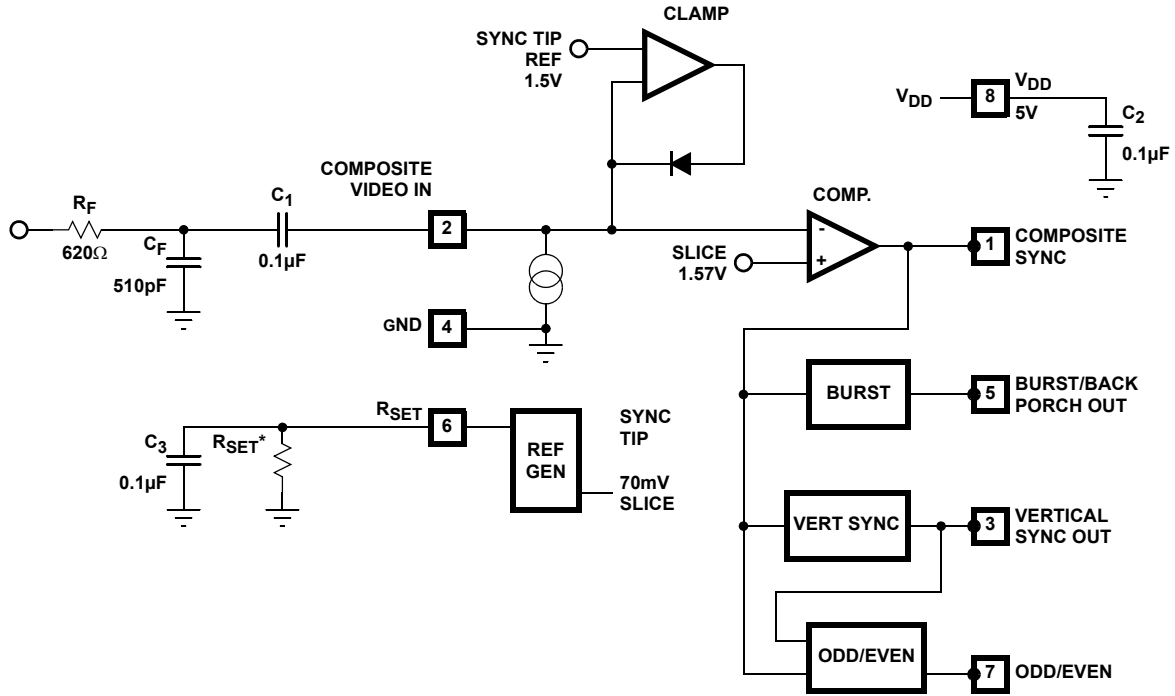

FIGURE 23.

**Simplified Block Diagram**



NOTE: \* R<sub>SET</sub> MUST BE AT 1% RESISTOR

FIGURE 24.

© Copyright Intersil Americas LLC 2002-2011. All Rights Reserved.  
 All trademarks and registered trademarks are the property of their respective owners.

For additional products, see [www.intersil.com/en/products.html](http://www.intersil.com/en/products.html)

Intersil products are manufactured, assembled and tested utilizing ISO9001 quality systems as noted in the quality certifications found at [www.intersil.com/en/support/qualandreliability.html](http://www.intersil.com/en/support/qualandreliability.html)

*Intersil products are sold by description only. Intersil may modify the circuit design and/or specifications of products at any time without notice, provided that such modification does not, in Intersil's sole judgment, affect the form, fit or function of the product. Accordingly, the reader is cautioned to verify that datasheets are current before placing orders. Information furnished by Intersil is believed to be accurate and reliable. However, no responsibility is assumed by Intersil or its subsidiaries for its use; nor for any infringements of patents or other rights of third parties which may result from its use. No license is granted by implication or otherwise under any patent or patent rights of Intersil or its subsidiaries.*

For information regarding Intersil Corporation and its products, see [www.intersil.com](http://www.intersil.com)

### Dual-In-Line Plastic Packages (PDIP)

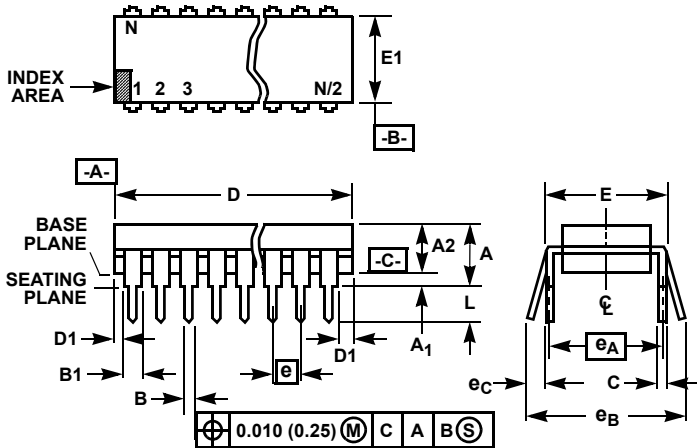

**NOTES:**

- Controlling Dimensions: INCH. In case of conflict between English and Metric dimensions, the inch dimensions control.
- Dimensioning and tolerancing per ANSI Y14.5M-1982.
- Symbols are defined in the "MO Series Symbol List" in Section 2.2 of Publication No. 95.
- Dimensions A, A1 and L are measured with the package seated in JEDEC seating plane gauge GS-3.
- D, D1, and E1 dimensions do not include mold flash or protrusions. Mold flash or protrusions shall not exceed 0.010 inch (0.25mm).
- E and e<sub>A</sub> are measured with the leads constrained to be perpendicular to datum -C-.
- e<sub>B</sub> and e<sub>C</sub> are measured at the lead tips with the leads unconstrained. e<sub>C</sub> must be zero or greater.
- B1 maximum dimensions do not include dambar protrusions. Dambar protrusions shall not exceed 0.010 inch (0.25mm).
- N is the maximum number of terminal positions.
- Corner leads (1, N, N/2 and N/2 + 1) for E8.3, E16.3, E18.3, E28.3, E42.6 will have a B1 dimension of 0.030 - 0.045 inch (0.76 - 1.14mm).

### E8.3 (JEDEC MS-001-BA ISSUE D) 8 LEAD DUAL-IN-LINE PLASTIC PACKAGE

| SYMBOL         | INCHES    |       | MILLIMETERS |       | NOTES |
|----------------|-----------|-------|-------------|-------|-------|
|                | MIN       | MAX   | MIN         | MAX   |       |
| A              | -         | 0.210 | -           | 5.33  | 4     |
| A1             | 0.015     | -     | 0.39        | -     | 4     |
| A2             | 0.115     | 0.195 | 2.93        | 4.95  | -     |
| B              | 0.014     | 0.022 | 0.356       | 0.558 | -     |
| B1             | 0.045     | 0.070 | 1.15        | 1.77  | 8, 10 |
| C              | 0.008     | 0.014 | 0.204       | 0.355 | -     |
| D              | 0.355     | 0.400 | 9.01        | 10.16 | 5     |
| D1             | 0.005     | -     | 0.13        | -     | 5     |
| E              | 0.300     | 0.325 | 7.62        | 8.25  | 6     |
| E1             | 0.240     | 0.280 | 6.10        | 7.11  | 5     |
| e              | 0.100 BSC |       | 2.54 BSC    |       | -     |
| e <sub>A</sub> | 0.300 BSC |       | 7.62 BSC    |       | 6     |
| e <sub>B</sub> | -         | 0.430 | -           | 10.92 | 7     |
| L              | 0.115     | 0.150 | 2.93        | 3.81  | 4     |
| N              | 8         |       | 8           |       | 9     |

Rev. 0 12/93

# Package Outline Drawing

## M8.15E

8 LEAD NARROW BODY SMALL OUTLINE PLASTIC PACKAGE

Rev 0, 08/09

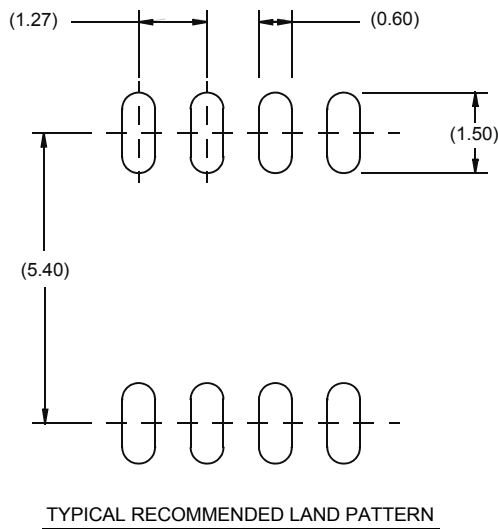
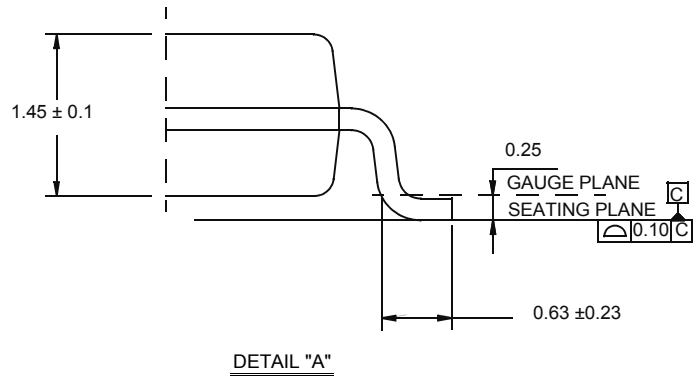
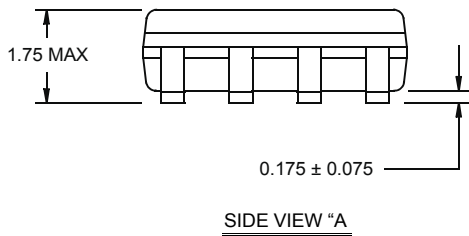
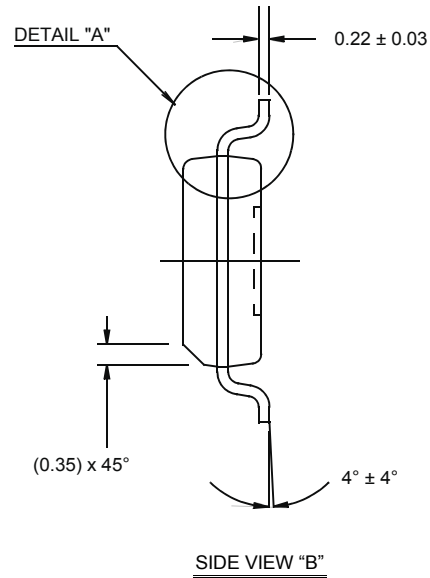
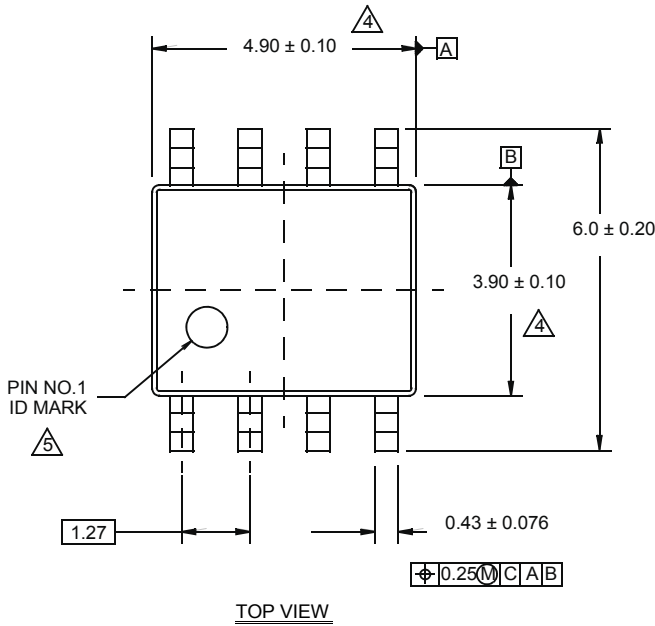

**NOTES:**

1. Dimensions are in millimeters.  
Dimensions in ( ) for Reference Only.
2. Dimensioning and tolerancing conform to AMSE Y14.5m-1994.
3. Unless otherwise specified, tolerance : Decimal ± 0.05
4. Dimension does not include interlead flash or protrusions.  
Interlead flash or protrusions shall not exceed 0.25mm per side.
5. The pin #1 identifier may be either a mold or mark feature.
6. Reference to JEDEC MS-012.



Компания «ЭлектроПласт» предлагает заключение долгосрочных отношений при поставках импортных электронных компонентов на взаимовыгодных условиях!

Наши преимущества:

- Оперативные поставки широкого спектра электронных компонентов отечественного и импортного производства напрямую от производителей и с крупнейших мировых складов;
- Поставка более 17-ти миллионов наименований электронных компонентов;
- Поставка сложных, дефицитных, либо снятых с производства позиций;
- Оперативные сроки поставки под заказ (от 5 рабочих дней);
- Экспресс доставка в любую точку России;
- Техническая поддержка проекта, помощь в подборе аналогов, поставка прототипов;
- Система менеджмента качества сертифицирована по Международному стандарту ISO 9001;
- Лицензия ФСБ на осуществление работ с использованием сведений, составляющих государственную тайну;
- Поставка специализированных компонентов (Xilinx, Altera, Analog Devices, Intersil, Interpoint, Microsemi, Aeroflex, Peregrine, Syfer, Eurofarad, Texas Instrument, Miteq, Cobham, E2V, MA-COM, Hittite, Mini-Circuits, General Dynamics и др.);

Помимо этого, одним из направлений компании «ЭлектроПласт» является направление «Источники питания». Мы предлагаем Вам помощь Конструкторского отдела:

- Подбор оптимального решения, техническое обоснование при выборе компонента;
- Подбор аналогов;
- Консультации по применению компонента;
- Поставка образцов и прототипов;
- Техническая поддержка проекта;
- Защита от снятия компонента с производства.



#### Как с нами связаться

**Телефон:** 8 (812) 309 58 32 (многоканальный)

**Факс:** 8 (812) 320-02-42

**Электронная почта:** [org@eplast1.ru](mailto:org@eplast1.ru)

**Адрес:** 198099, г. Санкт-Петербург, ул. Калинина, дом 2, корпус 4, литера А.