

**E5AR Digital Controllers offer high speed, high precision, and multiple I/O and use a 5-digit, 3-row LCD display for high visual clarity.**

- A short sampling period of 50 ms enables use in applications requiring high-speed response.
- PV, SP, and MV data is displayed simultaneously in a 3-row, negative LCD display with a backlight.
- Multiloop control, cascade control, and proportional control are possible with a single Controller.
- When using models with CompoWay/F communications, initial settings can be downloaded and settings can be masked using Support Software (CX-Thermo version 4.0 or higher).
- Equipped with calculation functions as a standard (e.g., square root calculation and broken-line approximation).
- DeviceNet Communications  
Data setting and monitoring can be performed without special programming.



Refer to *Safety Precautions for All E5□R Models*.

Refer to *E5AR/E5ER Operation* for operating procedures.

## Model Number Structure

### Model Number Legend

E5AR-□□□□□□□□□□-□□□□  
1 2 3 4 5 6 7 8 9 10

#### 1. Constant Values/Program

Blank: Constant value

#### 2. Control Method

Blank: Standard or heating/cooling control

P: Position proportional control

#### 3. Output 1

R: DPST-NO relay outputs

Q: Pulse voltage and pulse voltage/current outputs

C: Current and current outputs

#### 4. Output 2

Blank: None

R: Relay outputs

Q: Pulse voltage and pulse voltage/current outputs

C: Current and current outputs

#### 5. Auxiliary Outputs

Blank: None

4: 4PST-NO relay outputs

T: 2 transistor outputs

#### 6. Optional Function 1

Blank: None

3: RS-485 communications

#### 7. Optional Function 2

Blank: None

D: 4 event inputs

#### 8. Input 1

B: Universal-input and 2 event inputs

F: Universal-input and FB

W: Universal-input and universal-input

#### 9. Input 2

Blank: None

W: Universal-input and universal-input

#### 10. Communications Method

Blank: None

FLK: CompoWay/F

DRT: DeviceNet

**Note:** The above model number legend is intended as a functional description of models. Not all possible combinations of functions are available. Confirm model availability in *Ordering Information* when ordering.

The CX-Thermo Support Software (version 4.0 or higher) can be used to easily set parameters in conversational form.

**Note:** Be sure to read the precautions for correct use and other precautions in the following user's manual before using the Digital Controller.  
E5AR/E5ER Digital Controller User's Manual (Cat. No. Z182)  
E5AR/E5ER Digital Controller DeviceNet Communication User's Manual (Cat. No. H124)

# Ordering Information

## ■ Digital Controllers

### Standard Controllers

Size	Control type	Control mode	Outputs (control/transfer)	Optional functions			Model	
				Auxiliary outputs (SUB)	Event inputs	Serial communi- cations		
96 × 96 mm	Basic control (1 loop)	Single-loop standard control Single-loop heating and cooling control	2 points: Pulse voltage and Pulse voltage/current	4	2	No	E5AR-Q4B	
			2 points: Current and Current				E5AR-C4B	
			2 points: Pulse voltage and Pulse voltage/current				RS-485	E5AR-Q43B-FLK (See note 2.)
			2 points: Current and Current					E5AR-C43B-FLK (See note 2.)
			2 points: Pulse voltage and Pulse voltage/current				6	E5AR-Q43DB-FLK (See note 2.)
			2 points: Current and Current					E5AR-C43DB-FLK (See note 2.)
			4 points: Pulse voltage and Pulse voltage/current and Current (2 points)					E5AR-QC43DB-FLK
2-loop control	2-loop standard control Single-loop heating and cooling control Single-loop cascade control Single-loop control with remote SP Single-loop proportional control	2 points: Pulse voltage and Pulse voltage/current	4	4	RS-485	E5AR-Q43DW-FLK (See note 2.)		
		2 points: Current and Current				E5AR-C43DW-FLK (See note 2.)		
		4 points: Pulse voltage (2 points) and Pulse voltage/current (2 points)				E5AR-QQ43DW-FLK		
4-loop control	4-loop standard control 2-loop heating and cooling control	4 points: Current output (4 points)	4	4	RS-485	E5AR-CC43DWW-FLK		
		4 points: Pulse voltage (2 points) and Pulse voltage/current (2 points)				E5AR-QQ43DWW-FLK (See note 2.)		
Position-proportional control (1 loop)	Single-loop position-proportional control (See note 3.)	Relay output (1 open, 1 close)	4	4	No	E5AR-PR4DF		
		Relay output (1 open, 1 close) and 1 current (transfer) output				RS-485	E5AR-PRQ43DF-FLK	

**Note 1:** Specify the power supply specifications when ordering. Model numbers for 100 to 240 VAC are different from those for 24 VAC/VDC.

**2:** These models are for 100 to 240 VAC only.

**3:** Can be switched between close control and floating control.

## DeviceNet-compatible Controllers

Size	Control type	Control mode	Outputs (control/transfer)	Optional functions			Model
				Auxiliary outputs (SUB)	Event inputs	DeviceNet communi- cations	
96 × 96 mm	Basic control (1 loop)	1 loop for standard control Single-loop heating and cooling control	2 points: Pulse volt- age and Pulse volt- age/current	4	2	Yes	E5AR-Q4B-DRT
			2 points: Current and Current				E5AR-C4B-DRT
			4 points: Pulse volt- age and Pulse volt- age/current and Current (2 points)				E5AR-QC4B-DRT
	2-loop control	2-loop standard control 2-loop heating and cooling control Single-loop cascade control Single-loop control with remote SP Single-loop proportional control	4 points: Pulse volt- age (2 points) and Pulse voltage/cur- rent (2 points)	4	None	Yes	E5AR-QQ4W-DRT
	4-loop control	4-loop standard control 2-loop heating and cooling control	4 points: Current (4 points)	4	None	Yes	E5AR-CC4WW-DRT
Position-pro- portional con- trol (1 loop)	Single-loop position-proportional con- trol (See note 2.)	Relay output (1 open, 1 close)	4	None	Yes	E5AR-PR4F-DRT	
		Relay output (1 open, 1 close) and 1 current (transfer) output				E5AR-PRQ4F-DRT	

**Note:** 1. Specify the power supply specifications when ordering. Model numbers for 100 to 240 VAC are different from those for 24 VAC/VDC.  
2. Can be switched between close control and floating control.

### Inspection Results

The Inspection Report can be ordered at the same time as the Digital Controller using the following model number.

#### Inspection Report (Sold Separately)

Descriptions	Model
Inspection Report for E5AR	E5AR-K

### ■ Accessories (Order Separately)

#### Terminal Cover (Sold Separately)

Descriptions	Model
Terminal Cover for E5AR	E53-COV14

#### Unit Label Sheet

Model
Y92S-L1

#### Rubber Packing

Model
Y92S-P4

**Note:** The Rubber Packing is provided with the Digital Controller.

# Specifications



## ■ Ratings

Item	Supply voltage (See note 1.)	100 to 240 VAC, 50/60 Hz	24 VAC, 50/60 Hz; 24 VDC
Operating voltage range		85% to 110% of rated supply voltage	
Power consumption		22 VA max. (with maximum load)	15 VA/10 W max. (with maximum load)
Sensor input (See note 2.)		Thermocouple: K, J, T, E, L, U, N, R, S, B, W Platinum resistance thermometer: Pt100 Current input: 4 to 20 mA DC, 0 to 20 mA DC (including remote SP input) Voltage input: 1 to 5 VDC, 0 to 5 VDC, 0 to 10 VDC (including remote SP input) (Input impedance: 150 Ω for current input, approx. 1 MΩ for voltage input)	
Control output	Voltage (pulse) output	12 VDC, 40 mA max. with short-circuit protection circuit (E5AR-QQ□WW□: 21 mA max.)	
	Current output	0 to 20 mA DC, 4 to 20 mA DC; load: 500 Ω max. (including transfer output) (Resolution: Approx. 54,000 for 0 to 20 mA DC; Approx. 43,000 for 4 to 20 mA DC)	
	Relay output	Position-proportional control type (open, closed) N.O., 250 VAC, 1 A (including inrush current)	
Auxiliary output		Relay Output N.O., 250 VAC, 1 A (resistive load)	
Potentiometer input		100 Ω to 2.5 kΩ	
Event input	Contact	Input ON: 1 kΩ max.; OFF: 100 kΩ min.	
	No-contact	Input ON: Residual voltage of 1.5 V max.; OFF: Leakage current of 0.1 mA max.	
		Short-circuit: Approx. 4 mA	
Remote SP input		Refer to the information on sensor input.	
Transfer output		Refer to the information on control output.	
Control method		2-PID or ON/OFF control	
Setting method		Digital setting using front panel keys or setting using serial communications	
Indication method		7-segment digital display and single-lighting indicator Character Height PV: 12.8 mm; SV: 7.7 mm; MV: 7.7 mm	
Other functions		Depends on model.	
Ambient operating temperature		-10 to 55°C (with no icing or condensation) For 3 years of assured use: -10 to 50°C (with no icing or condensation)	
Ambient operating humidity		25% to 85%	
Storage temperature		-25 to 65°C (with no icing or condensation)	

- Note 1:** The supply voltage (i.e., 100 to 240 VAC or 24 VAC/VDC) depends on the model. Be sure to specify the required type when ordering.  
**Note 2:** The Controller is equipped with multiple sensor input. Temperature input or analog input can be selected with the input type setting switch. There is basic insulation between power supply and input terminals, power supply and output terminals, and input and output terminals.  
**Note 3:** Do not use an inverter output as the power supply. (Refer to *Safety Precautions for All E5□R Models*.)

## ■ Input Ranges

### Platinum Resistance Thermometer, Thermocouple, Current, or Voltage Input

Input type	Platinum Resistance Thermometer	Thermocouple														Current		Voltage				
		Name	Pt100	K	J	T	E	L	U	N	R	S	B	W (W/Re 5-26)	[mA]	[V]						
Temperature Range (°C)		850.0	1300.0	850.0	400.0	400.0	600.0	850.0	400.0	1300.0	1700.0	1700.0	1800.0	2300.0	20 to 4	20 to 0	5 to 1	5 to 0	10 to 0			
Setting		0	1	2	3	4	5	6	7	8	9	10	11	12	13	14	15	16	17	18	19	
Minimum setting unit (SP and alarm)	0.1°C	0.01°C	0.1°C														(Depends on scaling and number of decimal places.)					
Input type setting switch	Set to TC.PT. 														Set to ANALOG. 							

 The shaded area indicates the setting status at the time of purchase.

## ■ Characteristics

<b>Indication accuracy</b>	Thermocouple input with cold junction compensation: ( $\pm 0.1\%$ of PV or $\pm 1^\circ\text{C}$ , whichever is greater) $\pm 1$ digit max. (See note 1.) Thermocouple input without cold junction compensation: ( $\pm 0.1\%$ FS or $\pm 1^\circ\text{C}$ , whichever is smaller) $\pm 1$ digit (See note 2.) Analog input: $\pm 0.1\%$ FS $\pm 1$ digit max. Platinum resistance thermometer input: ( $\pm 0.1\%$ of PV or $\pm 0.5^\circ\text{C}$ , whichever is greater) $\pm 1$ digit max. Position-proportional potentiometer input: $\pm 5\%$ FS $\pm 1$ digit max.
<b>Control mode</b>	Standard control (heating or cooling control), heating/cooling control, standard control with remote SP (2-input models only), heating/cooling control with remote SP (2-input models only), cascade standard control (2-input models only), cascade heating/cooling control (2-input models only), proportional control (2-input models only), position-proportional control (control-valve control models only)
<b>Influence of temperature</b>	Thermocouple input (R, S, B, W): ( $\pm 1\%$ of PV or $\pm 10^\circ\text{C}$ , whichever is greater) $\pm 1$ digit max. Other thermocouple input: ( $\pm 1\%$ of PV or $\pm 4^\circ\text{C}$ , whichever is greater) $\pm 1$ digit max. *K-type thermocouple at $-100^\circ\text{C}$ max.: $\pm 10^\circ\text{C}$ max.
<b>Influence of voltage</b>	Platinum resistance thermometer: ( $\pm 1\%$ of PV or $\pm 2^\circ\text{C}$ , whichever is greater) $\pm 1$ digit max. Analog input: ( $\pm 1\%$ FS) $\pm 1$ digit max.
<b>Control period</b>	0.2 to 99.0 s (in units of 0.1 s) for time-proportioning control output
<b>Proportional band (P)</b>	0.00% to 999.99% FS (in units of 0.01% FS)
<b>Integral time (I)</b>	0.0 to 3,999.9 s (in units of 0.1 s)
<b>Derivative time (D)</b>	0.0 to 3,999.9 s (in units of 0.1 s)
<b>Hysteresis</b>	0.01% to 99.99% FS (in units of 0.01% FS)
<b>Manual reset value</b>	0.0% to 100.0% (in units of 0.1% FS)
<b>Alarm setting range</b>	-19,999 to 99,999 EU (See note 3.) (The decimal point position depends on the input type and the decimal point position setting.)
<b>Input sampling period</b>	50 ms
<b>Insulation resistance</b>	20 M $\Omega$ min. (at 500 VDC)
<b>Dielectric strength</b>	2,000 VAC, 50/60 Hz for 1 min (between charged terminals of different polarities)
<b>Vibration resistance</b>	10 to 55 Hz, 20 m/s <sup>2</sup> for 10 min each in X, Y, and Z directions
<b>Shock resistance</b>	100 m/s <sup>2</sup> , 3 times each in X, Y, and Z directions
<b>Inrush current</b>	100 to 240-VAC models: 50 A max. 24 VAC/VDC models: 30 A max.
<b>Weight</b>	Controller only: Approx. 450 g; Mounting bracket: Approx. 60 g; Terminal cover: Approx. 30 g
<b>Degree of protection</b>	Front panel: NEMA4X for indoor use (equivalent to IP66); Rear case: IP20; Terminals: IP00
<b>Memory protection</b>	Non-volatile memory (number of writes: 100,000)
<b>Applicable standards</b>	UL61010C-1, CSA C22.2 No. 1010-1 EN61010-1 (IEC61010-1): Pollution degree 2/overvoltage category 2
<b>EMC</b>	EMI: EN61326 Radiated Interference Electromagnetic Field Strength: EN55011 Group 1 Class A Noise Terminal Voltage: EN55011 Group 1 Class A  EMS: EN61326 ESD Immunity: EN61000-4-2: 4 kV contact discharge (level 2) 8 kV air discharge (level 3) Electromagnetic Immunity: EN61000-4-3: 10 V/m (amplitude-modulated, 80 MHz to 1 GHz, 1.4 GHz to 2 GHz) (level 3) Burst Noise Immunity: EN61000-4-4: 2 kV power line (level 3) 2 kV output line (relay output) (level 4) 1 kV measurement line, I/O signal line (level 4) 1 kV communications line (level 3) Conducted Disturbance Immunity: EN61000-4-6: 3 V (0.15 to 80 MHz) (level 3) Surge Immunity: EN61000-4-5: 1 kV line to line (power line, output line (relay output)) (level 2) 2 kV line to ground (power line, output line (relay output)) (level 3) Power Frequency Magnetic Field Immunity: EN61000-4-8: 30 A/m (50 Hz) continuous field Voltage Dip/Interrupting Immunity: EN61000-4-11: 0.5 cycle, 100% (rated voltage)

**Note 1:** K-, T-, or N-type thermocouple at  $-100^\circ\text{C}$  max.:  $\pm 2^\circ\text{C}$   $\pm 1$  digit max.

U- or L-type thermocouple:  $\pm 2^\circ\text{C}$   $\pm 1$  digit max.

B-type thermocouple at  $400^\circ\text{C}$  max.: No accuracy specification.

R- or S-type thermocouple at  $200^\circ\text{C}$  max.:  $\pm 3^\circ\text{C}$   $\pm 1$  digit max.

W-type thermocouple: ( $\pm 0.3\%$  of PV or  $\pm 3^\circ\text{C}$ , whichever is greater)  $\pm 1$  digit max.

**2:** U- or L-type thermocouple:  $\pm 1^\circ\text{C}$   $\pm 1$  digit

R- or S-type thermocouple at  $200^\circ\text{C}$  max.:  $\pm 1.5^\circ\text{C}$   $\pm 1$  digit

**3:** "EU" (Engineering Unit) represents the unit after scaling. If a temperature sensor is used it is either  $^\circ\text{C}$  or  $^\circ\text{F}$ .

**4:** Conditions: Ambient temperature from  $-10$  to  $23$  to  $55^\circ\text{C}$  and voltage of  $-15\%$  to  $10\%$  of rated voltage.

## ■ Communications Specifications

<b>Transmission path connection</b>	Multiple points
<b>Communications method</b>	RS-485 (two-wire, half duplex)
<b>Synchronization method</b>	Start-stop synchronization
<b>Baud rate</b>	9,600, 19,200, or 384,000 bps
<b>Transmission code</b>	ASCII
<b>Data bit length</b>	7 or 8 bits
<b>Stop bit length</b>	1 or 2 bits
<b>Error detection</b>	Vertical parity (none, even, odd) Block check character (BCC): CompoWay/F CRC-16: Modbus
<b>Flow control</b>	None
<b>Interface</b>	RS-485
<b>Retry function</b>	None
<b>Communications buffer</b>	217 bytes
<b>Communications response send wait time</b>	0 to 99 ms, Default: 20 ms

## DeviceNet

Item		Specifications			
<b>Communications protocol</b>		Conforms to DeviceNet			
<b>Communications functions</b>	<b>Remote I/O communications</b>	<ul style="list-style-type: none"> <li>Master-slave connections (polling, bit-strobe, COS, or cyclic)</li> <li>Conform to DeviceNet specifications.</li> </ul>			
	<b>I/O allocations</b>	<ul style="list-style-type: none"> <li>Can allocate any I/O data from the Configurator.</li> <li>Can allocate any data, such as parameters specific to the DeviceNet and the Digital Controller variable area.</li> <li>Up to 2 blocks for the IN Area, up to a total of 100 words.</li> <li>One block for the OUT Area, up to 100 words (first word is always allocated to Output Enable Bits).</li> </ul>			
	<b>Message communications</b>	<ul style="list-style-type: none"> <li>Explicit message communications</li> <li>CompoWay/F communications commands can be sent (commands are sent in explicit message format).</li> </ul>			
<b>Connection format</b>		Combination of multidrop and T-branch connections (for trunk and drop lines)			
<b>Baud rate</b>		DeviceNet: 500, 250, or 125 kbps, or automatic detection of master baud rate			
<b>Communications media</b>		Special 5-wire cable (2 signal lines, 2 power lines, and 1 shield line)			
<b>Communications distance</b>		Baud rate	Network length	Drop line length	Total drop line length
		500 kbps	100 m max. (100 m max.)	6 m max.	39 m max.
		250 kbps	250 m max. (100 m max.)	6 m max.	78 m max.
		125 kbps	500 m max. (100 m max.)	6 m max.	156 m max.
The values in parentheses apply when Thin Cables are used.					
<b>Supply voltage</b>		DeviceNet power supply: 24 VDC			
<b>Allowable voltage range</b>		DeviceNet power supply: 11 to 25 VDC			
<b>Current consumption</b>		50 mA max. (24 VDC)			
<b>Maximum number of nodes that can be connected</b>		64 (includes Configurator when used)			
<b>Maximum number of slaves that can be connected</b>		63			
<b>Error control</b>		CRC error detection			
<b>Power supply</b>		Power supplied from DeviceNet communications connector.			

# Wiring Terminals

## E5AR Standard Controller Connections

**E5AR-Q4B**

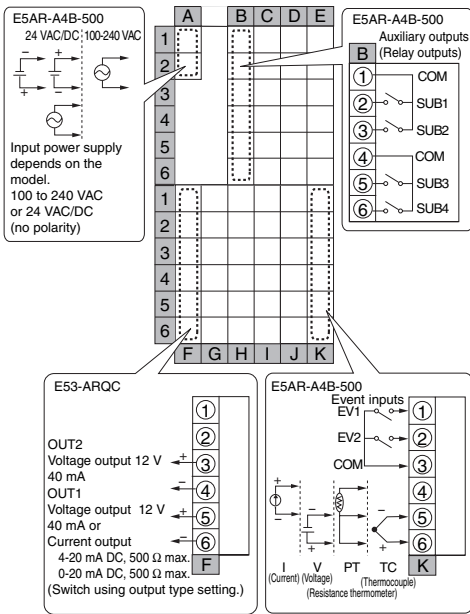

**E5AR-C4B**

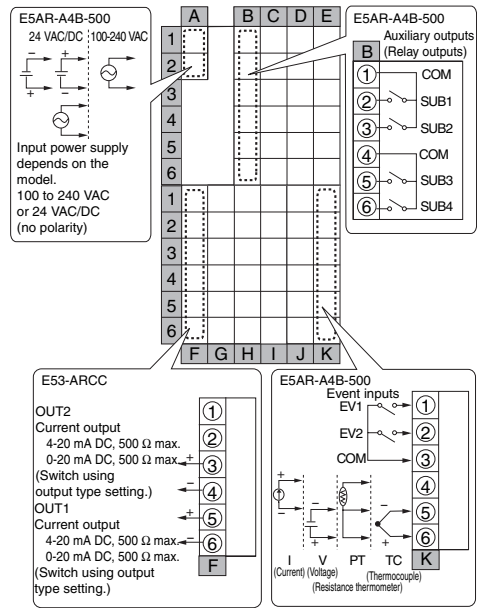

**E5AR-Q43B-FLK**

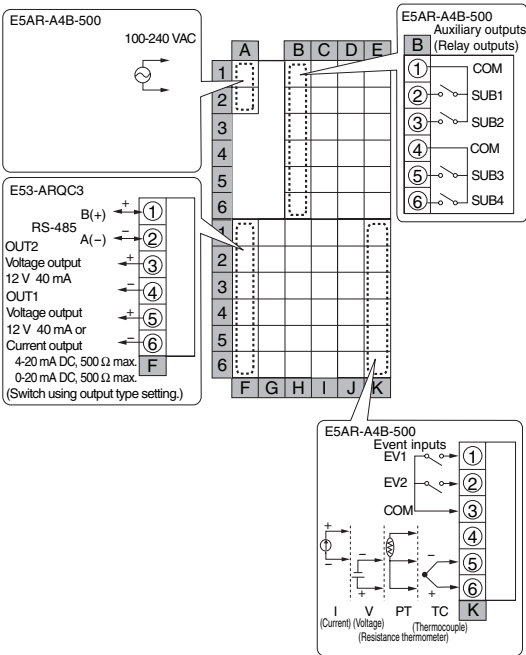

**E5AR-C43B-FLK**

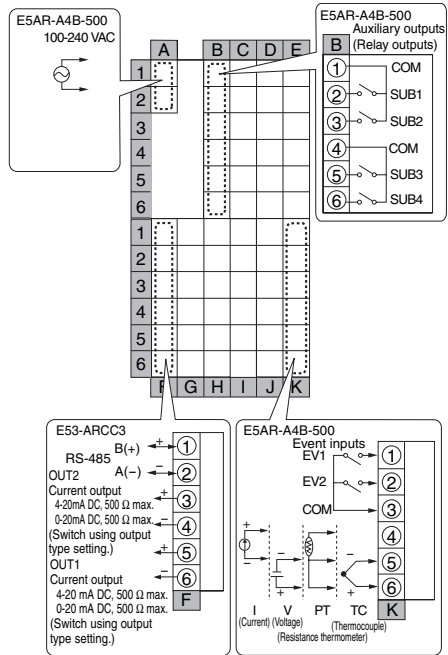

## E5AR-Q43DB-FLK

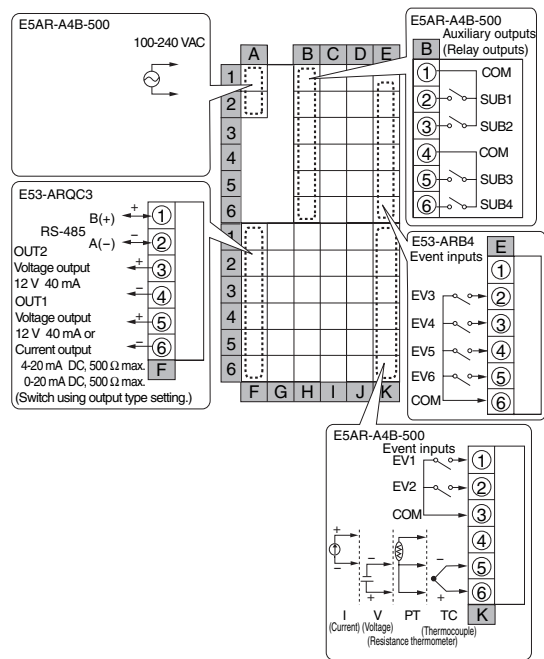

## E5AR-C43DB-FLK

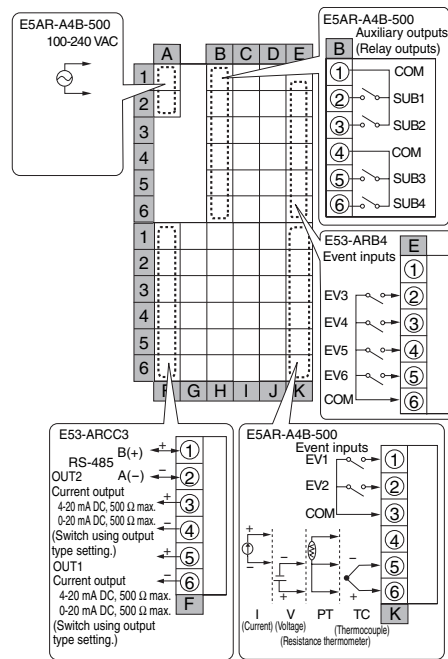

## E5AR-QC43DB-FLK

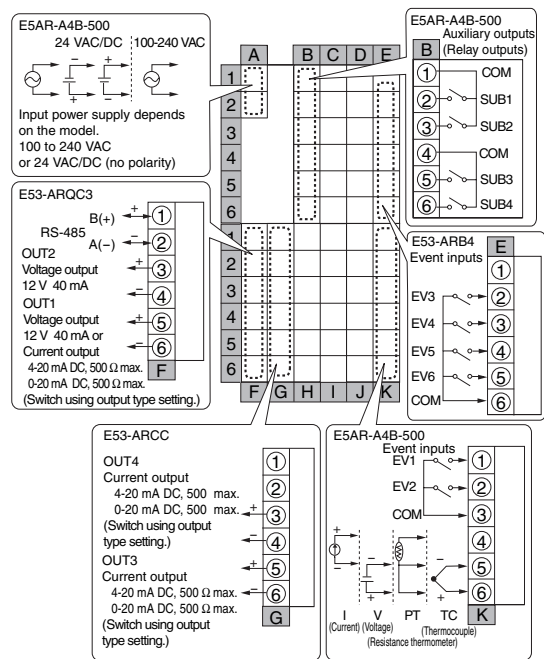



## E5AR-Q43DW-FLK (2-loop Control)



## E5AR-C43DW-FLK (2-loop Control)



## E5AR-QQ43DW-FLK (2-loop Control)

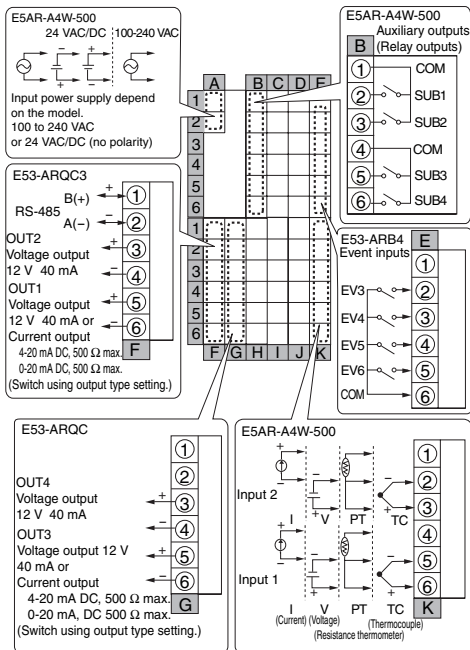

## E5AR-CC43DWW-FLK (4-loop Control)



## E5AR-QQ43DWW-FLK (4-loop Control)



## E5AR-PR4DF



## E5AR-PRQ43DF-FLK

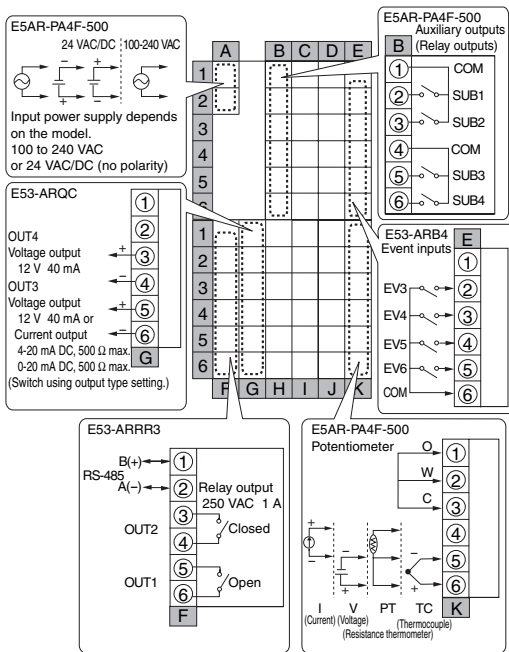

# E5AR DeviceNet-compatible Controller Connections

## E5AR-Q4B-DRT

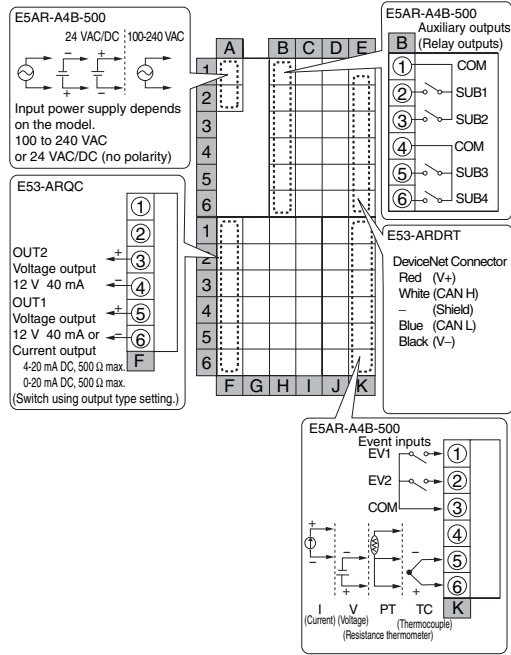

## E5AR-C4B-DRT

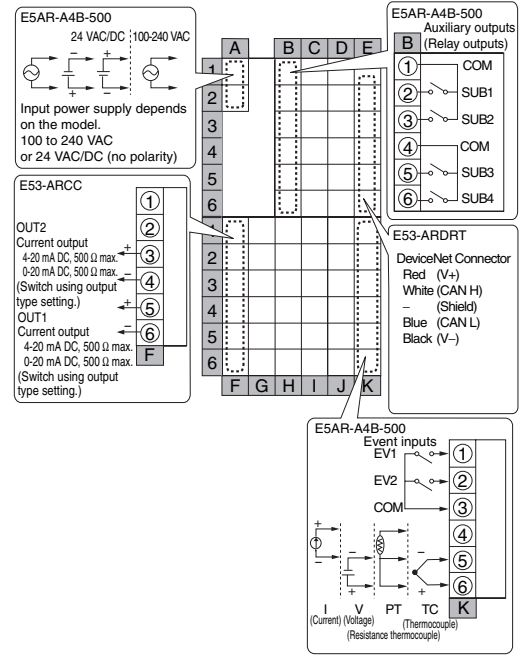

## E5AR-QC4B-DRT

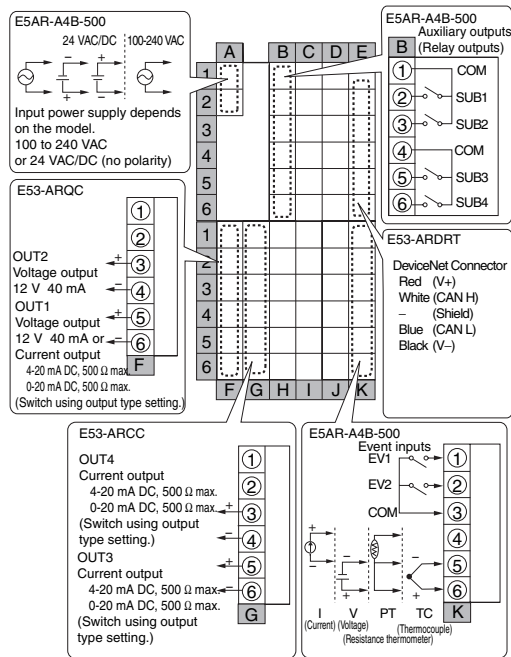

## E5AR-QQ4W-DRT (2-loop Control)

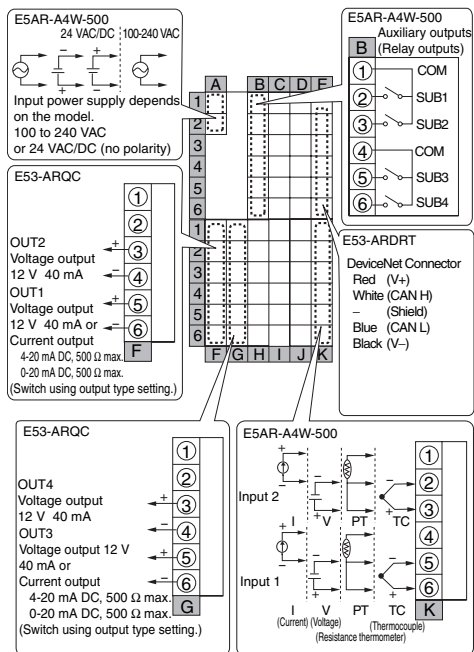

## E5AR-CC4WW-DRT (4-loop Control)

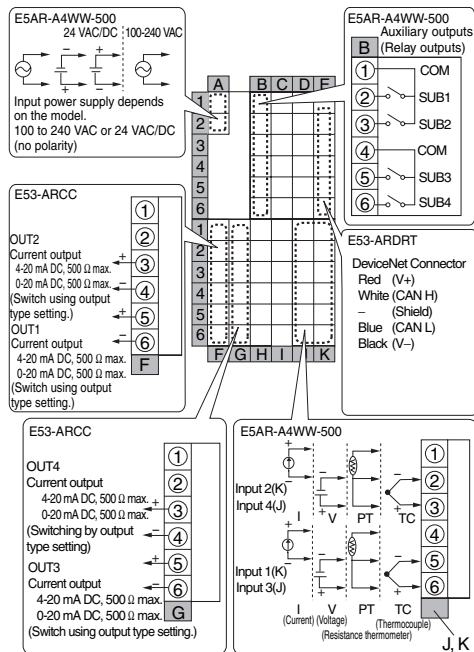

## E5AR-PR4F-DRT

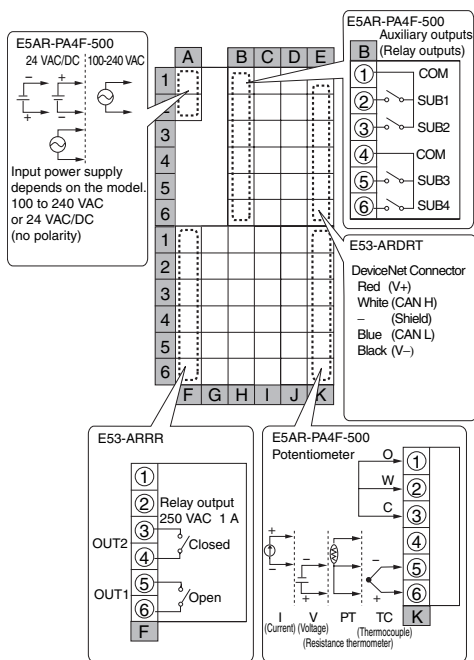

## E5AR-PRQ4F-DRT

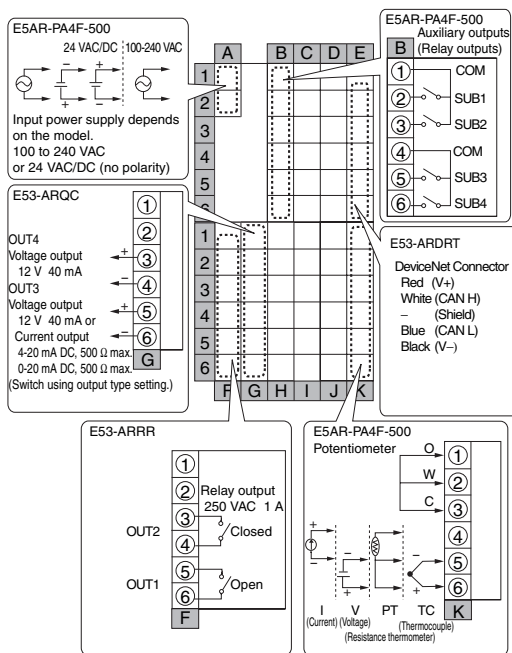

# Nomenclature

## E5AR

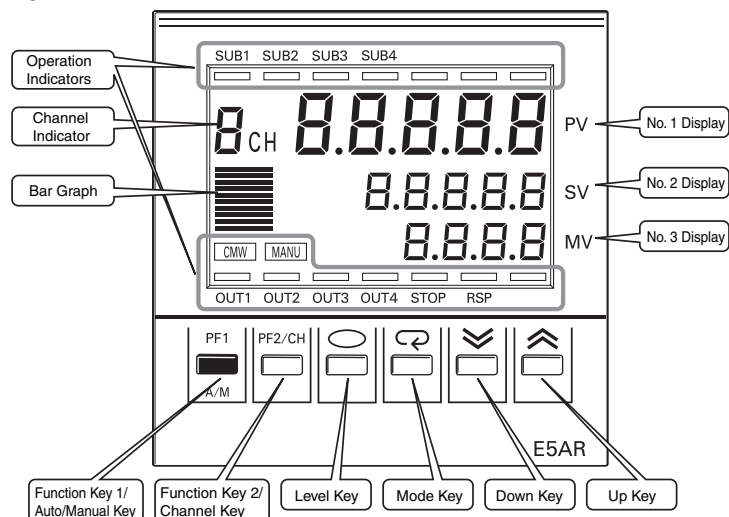

## DeviceNet-compatible Controllers, Rear Panel

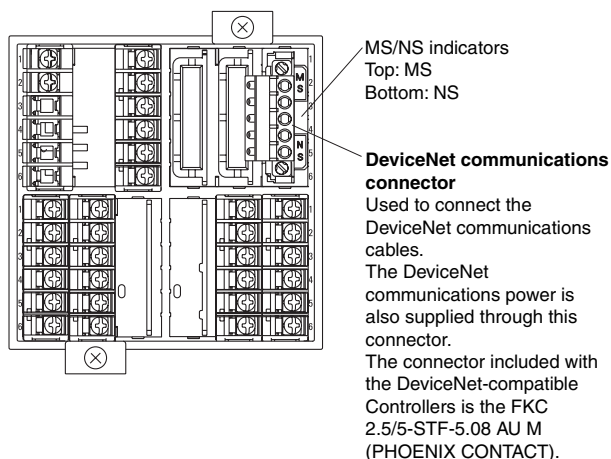

# Dimensions

Note: All units are in millimeters unless otherwise indicated.

## E5AR

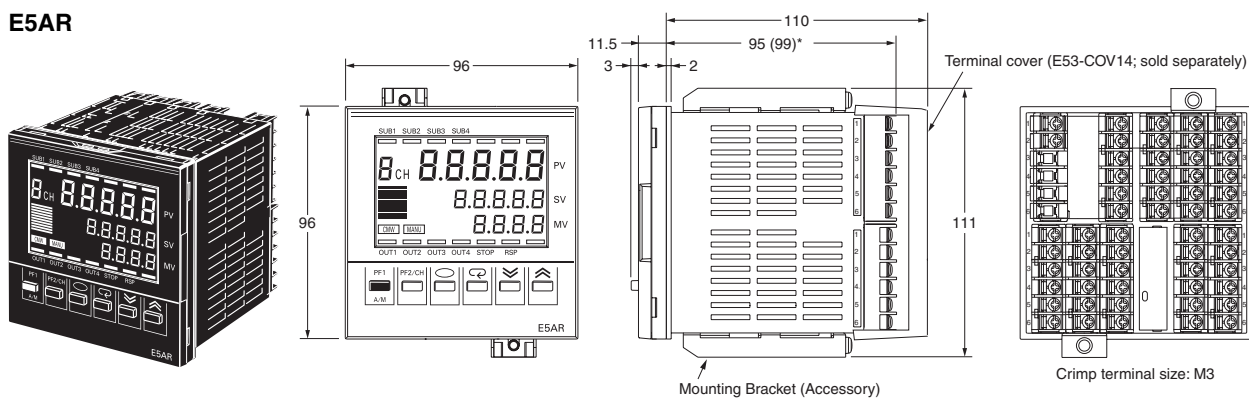

## Panel Cutouts

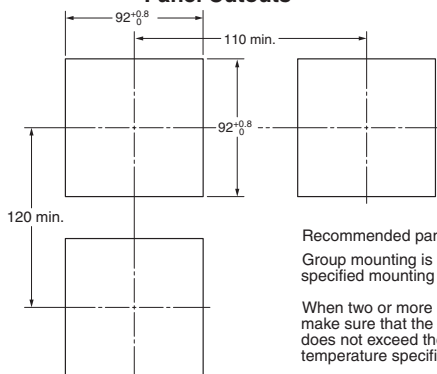

Recommended panel thickness is 1 to 8 mm.  
Group mounting is not possible. (Maintain the specified mounting space between Controllers.)

When two or more Controllers are mounted, make sure that the surrounding temperature does not exceed the allowable operating temperature specified in the specifications.

## ■ Accessories (Order Separately)

### Terminal Cover

E53-COV14 (for E5AR)

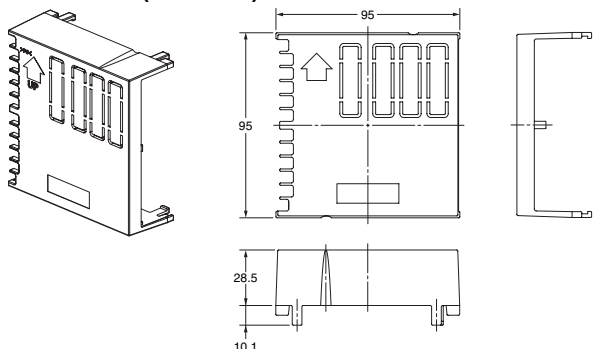

### Unit Label Sheet

Y92S-L1

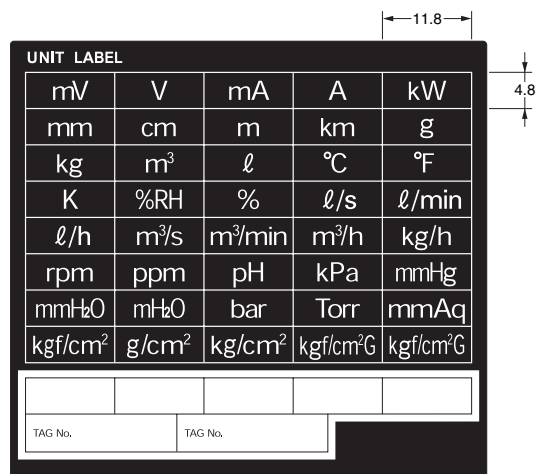

### Rubber Packing

Y92S-P4 (for DIN96 × 96)



Order the Rubber Packing separately if it becomes lost or damaged. (Refer to page 3.)

The Rubber Packing can be used to achieve an IP66 degree of protection.

(Deterioration, shrinking, or hardening of the rubber packing may occur depending on the operating environment.

Therefore, periodic replacement is recommended to ensure the level of waterproofing specified in NEMA4. The time for periodic replacement depends on the operating environment. Be sure to confirm this point at your site. Consider one year a rough standard. OMRON shall not be liable for the level of water resistance if the customer does not perform periodic replacement.)

The Rubber Packing does not need to be attached if a waterproof structure is not required.

ALL DIMENSIONS SHOWN ARE IN MILLIMETERS.

To convert millimeters into inches, multiply by 0.03937. To convert grams into ounces, multiply by 0.03527.

In the interest of product improvement, specifications are subject to change without notice.

## Read and Understand This Catalog

Please read and understand this catalog before purchasing the products. Please consult your OMRON representative if you have any questions or comments.

## Warranty and Limitations of Liability

### WARRANTY

OMRON's exclusive warranty is that the products are free from defects in materials and workmanship for a period of one year (or other period if specified) from date of sale by OMRON.

OMRON MAKES NO WARRANTY OR REPRESENTATION, EXPRESS OR IMPLIED, REGARDING NON-INFRINGEMENT, MERCHANTABILITY, OR FITNESS FOR PARTICULAR PURPOSE OF THE PRODUCTS. ANY BUYER OR USER ACKNOWLEDGES THAT THE BUYER OR USER ALONE HAS DETERMINED THAT THE PRODUCTS WILL SUITABLY MEET THE REQUIREMENTS OF THEIR INTENDED USE. OMRON DISCLAIMS ALL OTHER WARRANTIES, EXPRESS OR IMPLIED.

### LIMITATIONS OF LIABILITY

OMRON SHALL NOT BE RESPONSIBLE FOR SPECIAL, INDIRECT, OR CONSEQUENTIAL DAMAGES, LOSS OF PROFITS OR COMMERCIAL LOSS IN ANY WAY CONNECTED WITH THE PRODUCTS, WHETHER SUCH CLAIM IS BASED ON CONTRACT, WARRANTY, NEGLIGENCE, OR STRICT LIABILITY.

In no event shall the responsibility of OMRON for any act exceed the individual price of the product on which liability is asserted.

IN NO EVENT SHALL OMRON BE RESPONSIBLE FOR WARRANTY, REPAIR, OR OTHER CLAIMS REGARDING THE PRODUCTS UNLESS OMRON'S ANALYSIS CONFIRMS THAT THE PRODUCTS WERE PROPERLY HANDLED, STORED, INSTALLED, AND MAINTAINED AND NOT SUBJECT TO CONTAMINATION, ABUSE, MISUSE, OR INAPPROPRIATE MODIFICATION OR REPAIR.

## Application Considerations

### SUITABILITY FOR USE

OMRON shall not be responsible for conformity with any standards, codes, or regulations that apply to the combination of products in the customer's application or use of the products.

At the customer's request, OMRON will provide applicable third party certification documents identifying ratings and limitations of use that apply to the products. This information by itself is not sufficient for a complete determination of the suitability of the products in combination with the end product, machine, system, or other application or use.

The following are some examples of applications for which particular attention must be given. This is not intended to be an exhaustive list of all possible uses of the products, nor is it intended to imply that the uses listed may be suitable for the products:

- Outdoor use, uses involving potential chemical contamination or electrical interference, or conditions or uses not described in this catalog.
- Nuclear energy control systems, combustion systems, railroad systems, aviation systems, medical equipment, amusement machines, vehicles, safety equipment, and installations subject to separate industry or government regulations.
- Systems, machines, and equipment that could present a risk to life or property.

Please know and observe all prohibitions of use applicable to the products.

NEVER USE THE PRODUCTS FOR AN APPLICATION INVOLVING SERIOUS RISK TO LIFE OR PROPERTY WITHOUT ENSURING THAT THE SYSTEM AS A WHOLE HAS BEEN DESIGNED TO ADDRESS THE RISKS, AND THAT THE OMRON PRODUCTS ARE PROPERLY RATED AND INSTALLED FOR THE INTENDED USE WITHIN THE OVERALL EQUIPMENT OR SYSTEM.

### PROGRAMMABLE PRODUCTS

OMRON shall not be responsible for the user's programming of a programmable product, or any consequence thereof.

## Disclaimers

### CHANGE IN SPECIFICATIONS

Product specifications and accessories may be changed at any time based on improvements and other reasons.

It is our practice to change model numbers when published ratings or features are changed, or when significant construction changes are made. However, some specifications of the products may be changed without any notice. When in doubt, special model numbers may be assigned to fix or establish key specifications for your application on your request. Please consult with your OMRON representative at any time to confirm actual specifications of purchased products.

### DIMENSIONS AND WEIGHTS

Dimensions and weights are nominal and are not to be used for manufacturing purposes, even when tolerances are shown.

### PERFORMANCE DATA

Performance data given in this catalog is provided as a guide for the user in determining suitability and does not constitute a warranty. It may represent the result of OMRON's test conditions, and the users must correlate it to actual application requirements. Actual performance is subject to the OMRON Warranty and Limitations of Liability.

### ERRORS AND OMISSIONS

The information in this document has been carefully checked and is believed to be accurate; however, no responsibility is assumed for clerical, typographical, or proofreading errors, or omissions.

2010.12

In the interest of product improvement, specifications are subject to change without notice.

**OMRON Corporation**  
Industrial Automation Company

<http://www.ia.omron.com/>

(c)Copyright OMRON Corporation 2010 All Right Reserved.



Компания «ЭлектроПласт» предлагает заключение долгосрочных отношений при поставках импортных электронных компонентов на взаимовыгодных условиях!

Наши преимущества:

- Оперативные поставки широкого спектра электронных компонентов отечественного и импортного производства напрямую от производителей и с крупнейших мировых складов;
- Поставка более 17-ти миллионов наименований электронных компонентов;
- Поставка сложных, дефицитных, либо снятых с производства позиций;
- Оперативные сроки поставки под заказ (от 5 рабочих дней);
- Экспресс доставка в любую точку России;
- Техническая поддержка проекта, помощь в подборе аналогов, поставка прототипов;
- Система менеджмента качества сертифицирована по Международному стандарту ISO 9001;
- Лицензия ФСБ на осуществление работ с использованием сведений, составляющих государственную тайну;
- Поставка специализированных компонентов (Xilinx, Altera, Analog Devices, Intersil, Interpoint, Microsemi, Aeroflex, Peregrine, Syfer, Eurofarad, Texas Instrument, Miteq, Cobham, E2V, MA-COM, Hittite, Mini-Circuits, General Dynamics и др.);

Помимо этого, одним из направлений компании «ЭлектроПласт» является направление «Источники питания». Мы предлагаем Вам помощь Конструкторского отдела:

- Подбор оптимального решения, техническое обоснование при выборе компонента;
- Подбор аналогов;
- Консультации по применению компонента;
- Поставка образцов и прототипов;
- Техническая поддержка проекта;
- Защита от снятия компонента с производства.



#### Как с нами связаться

**Телефон:** 8 (812) 309 58 32 (многоканальный)

**Факс:** 8 (812) 320-02-42

**Электронная почта:** [org@eplast1.ru](mailto:org@eplast1.ru)

**Адрес:** 198099, г. Санкт-Петербург, ул. Калинина, дом 2, корпус 4, литера А.